

Mini-Micro Systems

A CAHNERS PUBLICATION

NOVEMBER 1983

TeleVideo's portable terminal challenges micros

How Osborne fell on hard times
PROFILE: Low-cost terminals get smarter



You've concluded that you need the performance and capacity that only an 8 inch Winchester drive can provide. Which one should you buy?

There are 109 different models available.

Of this 109, only 39 are 8 inch floppy form-factor compatible.

28 of these 109 perform an average seek in 30 milliseconds or less.

And of this 109, only 17 offer true SMD compatibility.

Puzzled?

Only *one* company provides a disk drive with all the features —

Kennedy and Model 7300

with the right size, the right interfaces and the right price.

Write or give us a call.

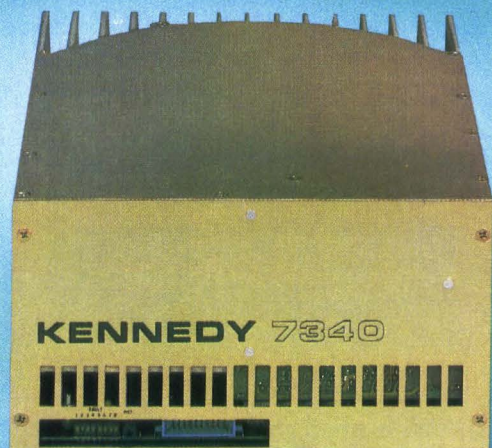
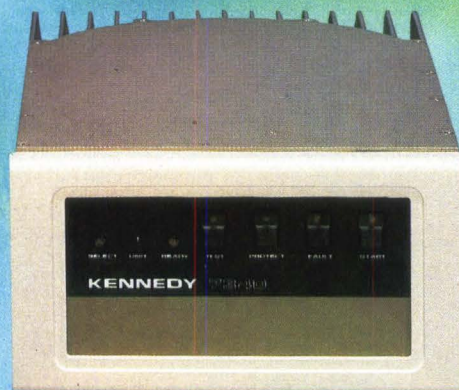

KENNEDY

An Allegheny International Company

1600 Shamrock Ave., Monrovia, CA. 91016

(213) 357-8831 TELEX 472-0116 KENNEDY

TWX 910-585-3249

SPECIFICATIONS:

- 41 and 82 MB Capacities
- Rotary Voice Coil 30 msec average seek
- SMD, ANSI or PICO BUS Interfaces
- 1209 KByte/sec. transfer rate
- Available 30-45 days ARO
- Q100: \$2,560/\$3,195

KENNEDY • QUALITY • COUNT ON IT

CIRCLE NO. 136 ON INQUIRY CARD

With all the clamor about personal computers, a fundamental fact is often overlooked: some simply *work* better than others.

Consider the COMPAQ Portable.

A computer will make you more productive. A computer will make you more efficient. You hear it everywhere. But you don't hear much about which computer actually *works* best.

The COMPAQ Portable fits under a standard airline seat for business trips.

Works in more places

With the COMPAQ™ Portable, you can be as productive in your hotel room or your lake house as in your own office. It's a reliable companion on a business trip. It's a powerful sales aid in your customer's office.

You can move it from office to office to share its resources. You can move it into the conference room to answer questions.

What's more productive than a computer? A computer that works for you in more places.

Works with the greatest number of programs

The most important consideration when choosing a computer is "what programs will it run?"

The COMPAQ Portable runs more programs than any other portable. In fact, it runs more than most non-portables because it runs all the popular programs written for the IBM® Personal Computer without any modification. There are hundreds of them. They are available at computer stores all over the country.

Imagine the power of a *portable* word processor. There are dozens of word processing programs available for the COMPAQ Portable.

Planning, problem-solving, and "what-ifs" are a cinch with a variety of popular electronic spreadsheet programs. The COMPAQ Portable

runs them all.

There are accounting programs for anything from computerizing your family budget to full-scale professional management of payables, receivables, inventory, and payroll.

There are programs for making charts and programs for communicating with other computers.

So you get portability and you don't give up problem-solving power.

The combination adds up to the most useful personal computer on the market today.

Add-on options make it work the way you work

Inside the COMPAQ Portable are three open slots. Most portables don't have any. Electronic devices called expansion boards fit those slots and give the COMPAQ Portable new powers. As with programs, expansion boards designed for the IBM will work. With them, you can make your personal computer more personal.

Want to check a stock price? One expansion board enables the COMPAQ Portable to handle those communications over ordinary phone lines.

Want to use your company's central computer files while you're on a trip? There are boards that allow the COMPAQ Portable to communicate with a variety of large computers.

Other boards let you hook up controllers for computer games, increase memory capacity, or connect several personal computers in a network.

The added usefulness is free

The COMPAQ Portable doesn't cost any more than an ordinary desktop computer. In fact, it costs hundreds less than a comparably equipped IBM or Apple® III. The COMPAQ Portable comes standard with one disk drive and 128K bytes of memory, both of which are usually extra-cost options.

The bottom line is this—you just can't



All the popular programs written for the IBM PC run as is on the COMPAQ Portable.

buy a more practical, useful, productive computer. Compare the COMPAQ Portable.

For the location of the Authorized Dealer nearest you, call 1-800-231-9966.

©1983 COMPAQ Computer Corporation
COMPAQ™ is a trademark of COMPAQ Computer Corporation.
IBM® is a registered trademark of International Business Machines Corporation.
Apple® is a registered trademark of Apple Computer Corporation.



COMPAQ™

The most computer you can carry

Mini-Micro Systems

MINI-MICRO WORLD

News

Televideo's \$469 portable personal terminal challenges microcomputers (p. 27) . . . Intel touts synchronous Multibus II's open system architecture (p. 30) . . . Non-volatile memories rejuvenate as bubble prices burst (p. 41) . . . Liberty offers \$745 terminal with more features, 12-inch screen (p. 46) . . . Heard on the Hill: AI emerges from the shadows (p. 51) . . . Software protection again under review; Apple aces Franklin (p. 54)

Corporate and Financial

Osborne Computer self destructs (p. 65) . . . DEC faces fierce competition during critical transition (p. 69) . . . Corporate and financial briefs (p. 80)

International

Processor-independent STE bus standard expected from IEEE (p. 85) . . . Overheard Overseas: Ericsson prepares for major personal computer push (p. 86) . . . Siemens, Bull, ICL aim research at better knowledge-based systems (p. 89)

INTERPRETER

- 99 Crowded disk market forces entrepreneurs to be cautious
- 117 IBM looks to third parties to provide graphics software for PC applications

SYSTEMS IN MANUFACTURING

- 125 Distribution resource planning systems pick up where MRP systems leave off
- 129 Star targets array-processor system for research applications
- 133 Intelligent controller is alternative to dedicated industrial terminals

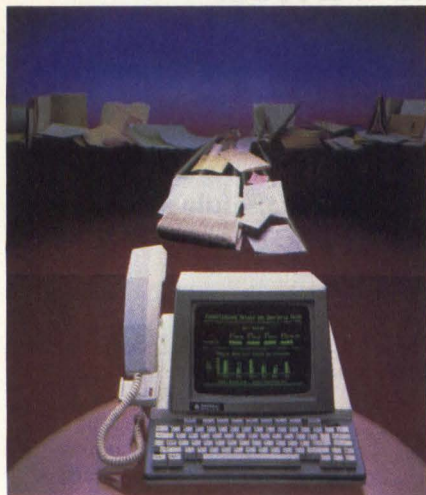

p. 27 . . . Art direction by Marc Marvin and Wayne Carey, photography by Rudy Legname, courtesy of TeleVideo Inc.

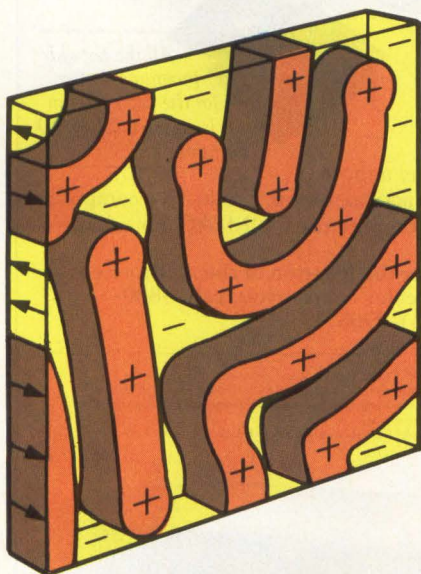

p. 41 Bubble prices burst

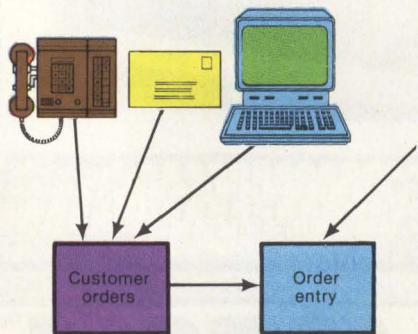

p. 125 Manufacturers turn to DRP

FEATURES

137 Feature Highlights

141 Low-cost display terminals gain in capability . . . less-than-\$1,000 full-screen alphanumeric terminals provide features typical of their higher-priced counterparts.

173 Using 'autoconvergence' in a color display . . . a step up from analog or digital convergence, which require adjustment by a trained technician or an operator.

183 Implementation strategies for voice-processing terminals . . . multichannel, multifunction voice utility combines major speech technologies.

201 Design trade-offs in a multifunction graphics terminal . . . color-graphics engineering terminal combines text and color in a low-cost, versatile workstation.

215 UNIX-based graphics system produces 1 million-pixel display . . . bit-mapping graphics board joins 16-bit CPU card to furnish near-photo-quality resolution.

229 Comdex/Fall '83 preview . . . fifth annual small systems conference and exposition emphasizes major operating systems, key languages and application packages.

241 10M-bps LAN combines benefits of CSMA/CD and token passing . . . network uses different access methods to serve multitasking and multivendor environments.

255 Tailoring UNIX for the supermicro business environment . . . MC68000-based micro incorporates Unify DBMS and enhances UNIX's data communications and user interface.

DEPARTMENTS

- | | |
|-------------------|----------------------------|
| 4 Editorial Staff | 269 New Products |
| 7 Editorial | 295 Mini-Micro Marketplace |
| 11 Breakpoints | 297 Classified Advertising |
| 80 Box Score | 298 Career Opportunities |
| 264 Calendar | 304 Index to Advertisers |

MINI-MICRO SYSTEMS (ISSN 0364-9342) is published monthly (with additional issues in spring and fall) by Cahners Publishing Company, Division of Reed Holdings, Inc., 221 Columbus Avenue, Boston, MA 02116. Norman L. Cahners, Chairman; Saul Goldweitz, President; Ronald G. Segel, Financial Vice President and Treasurer. MINI-MICRO SYSTEMS is published by the Cahners Magazine Division; J. A. Sheehan, President; William Platt, Executive Vice President; H. Victor Drumm, Group Vice President. Circulation records are maintained at Cahners Publishing Co., 270 St. Paul St., Denver, CO 80206. Second class postage paid at Denver, CO 80202 and additional mailing offices. Postmaster: Send address changes to MINI-MICRO SYSTEMS, 270 St. Paul St., Denver, CO 80206. MINI-MICRO SYSTEMS is circulated without charge by name and title to U.S. and Western Europe based corporate and technical management, systems engineers, and other personnel who meet qualification procedures. Available to others at the rate of \$45.00 per year in the U.S.; \$50.00 in Canada and Mexico; \$65.00 surface mail in all other countries; \$100 foreign air mail (14 issues). Single issues \$4.00 in the U.S.; \$5.00 in Canada and Mexico; \$6.00 in all other countries.

© 1983 by Cahners Publishing Company, Division of Reed Holdings, Inc. All rights reserved.

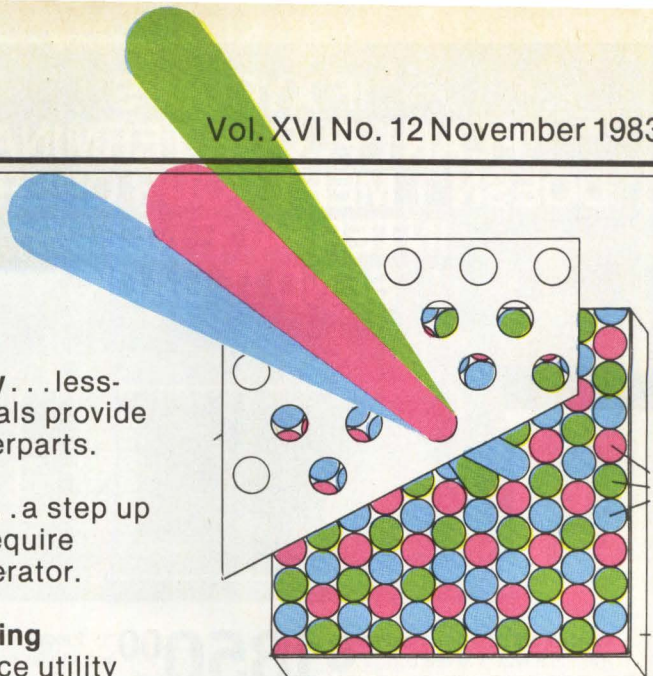

p. 173 Adjusting convergence

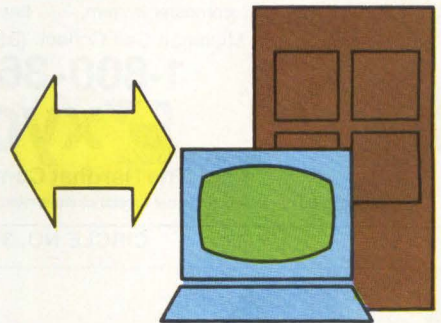

p. 183 Implementing voice technology

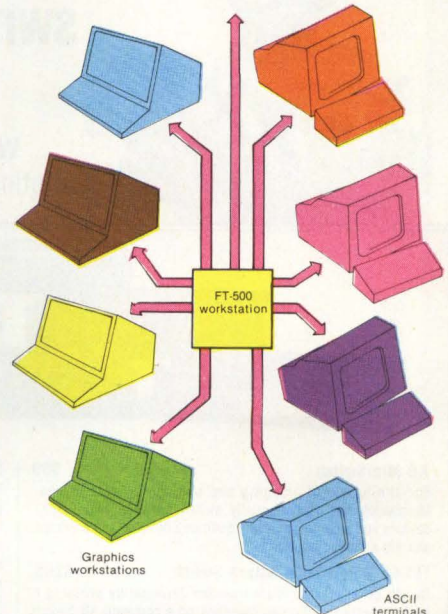

p. 215 High resolution graphics board

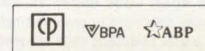

IF XYCOM'S PLANT FLOOR TERMINAL DOESN'T MEET YOUR OPERATOR INTERFACE NEEDS, SEND IT BACK.



- High performance, non-intelligent video display device
- Rack or front panel mounting

- RS232 interface standard, options available
- 9" CRT with multiple display attributes
- Front panel fully sealed

Order XYCOM's new RacPac Terminal now. We are convinced that it is the perfect operator work station, production info center, or message display station for use on plant floors. And it's compatible with your microcomputer system, **\$1850⁰⁰**** and similar computing devices. If you aren't convinced that the RacPac Terminal meets your plant floor needs — send it back. We ship from stock with a 30-day money-back guarantee,* one year limited product warranty.

In Michigan Call Collect: (313) 429-4971, ext. 337D.

1-800-367-7300



The Hardhat Computer People

*In effect for 30 days after customer receipt of equipment.

**O.E.M. quantity discounts available.

CIRCLE NO. 3 ON INQUIRY CARD



SWITCHING TERMINALS A PROBLEM?

WTI has a lineup of low cost solutions... RS232 Switching Devices!



AB MiniSwitch \$89

End the hassle of plugging and unplugging data cables. MiniSwitch lets you manually switch between two RS232 devices and a common device such as a Modem and a Printer sharing a Minicomputer.

TM-41 4 Port Push Button Switch \$295

Switch ports electronically from the Terminal by pressing a button instead of flipping switches on a common AB Switch box. Selectable operating modes include—equal priority lockout, multiple and single port select.

CAS-41 4 Port ASCII Code Activated Switch \$395

Your Computer may select one or any combination of up to 4 RS232 ports by a user selectable code sequence.

CAS-161 16 to 64 Port Code Activated Switch \$795

Your Computer may select between any one of 16 ports by a two character ASCII code sequence. The unit is field expandable to 32, 48, or 64 ports.

SMRT-1 8 Port "Smart Switch" \$895

This flexible microprocessor controlled 8 port switch allows a user on any port to communicate with an RS232 device on any other port. Up to 4 pairs of users can communicate simultaneously. "User Friendly" commands aid in port selection, port status and sign off. The unit's so smart, it even signals you when the port you wanted is no longer busy! Each port can be configured for DTE or DCE by pressing a button.

PSU-41 Printer Port Sharing Unit \$395

Allows up to 4 CRTs to share one Printer automatically without software changes! The PSU-41 scans each CRT and locks on until the screen has been sent to the Printer, then resumes scanning.



western telematic inc.
2435 S. Anne St., Santa Ana, CA 92704 • (714) 979-0363
Outside California call toll free (800) 854-7226

CIRCLE NO. 4 ON INQUIRY CARD

STAFF

Vice President/Publisher
S. Henry Sacks

Editor-in-Chief
George V. Kotelly

Managing Editor
James F. Donohue

Executive Editor:
Alan R. Kaplan

Senior Editor: **Lori Valigra**

Associate Editor: **Frank Catalano**
Associate Editor: **Edward S. Foster**,
Los Angeles, (213)826-5818

Associate Editor: **Roy R. Friedman**
Associate Editor: **Sarah Glazer**
Associate Editor: **Geoff Lewis**,
New York, (212)949-4446

Associate Editor: **Tom Moran**,
San Jose, (408)296-0868

Associate Editor: **Robert A. Sehr**,
San Jose, (408)296-0868

Associate Editor: **David R. Simpson**
Associate Editor: **Jesse Victor**

Assistant Editor: **David Bright**

Assistant Editor/New Products: **Steven F. Frann**
Assistant Editor/Research: **Adrienne DeLeonardo**

Contributing Editors:

London: **Keith Jones**, (011-441-661-3040)
Data Communications: **Walter A. Levy**

Computer Architecture: **Efrem Mallach**
Office Automation: **John Murphy**

Frankfurt: **Maureen O'Gara**

Artificial Intelligence: **Steven Roberts**
Washington, D.C.: **Steven J. Shaw**, (301)320-2273

Product Profiles: **Malcolm L. Stiefel**
Database Systems: **Harvey Weiss**

Editorial Production

Senior Copy Editor: **Frances T. Granville**

Production Editor: **Mary Anne Weeks**

Copy Editor: **Susan A. Hughes**

Word Processing: **Kathleen Appignani**

Administrative Assistant: **Frances C. Michalski**

Editorial Services

Helen M. Benedict, **Laura Downey**,
Jeanne Howat, **Robin Sheehan**

Art Staff

Art Director: **Vicki Blake**
Assistant Art Director: **Douglas Glen**
Artist: **Anne Tregay**

Production Staff

Supervisor: **William Tomaselli**
Production Manager: **Nancy Norton**
Composition: **Diane Malone**

Executive VP/Group Publisher
H. Victor Drumm

VP/Group Editorial Director: **Roy Forsberg**

Director of Graphics: **Lee Addington**

VP/President, Production: **Wayne Hulitzky**

VP/Research: **Ira Siegel**

Assistant to the Publisher: **Linda L. Lovett**

Group Circulation Manager: **Sherri Gronli**
(303)388-4511

Marketing/Promotion Staff

Marketing Director: **Richard B. Dalrymple**
Promotion Director: **Susan Rapaport**
Promotion Coordinator: **Elizabeth Gotoff**
Promotion Coordinator: **Wendy Whittemore**

Editorial Offices

Boston: 221 Columbus Ave., Boston, MA 02116, (617)536-7780. **Los Angeles:** 12233 W. Olympic Blvd., Los Angeles, CA 90064. **San Jose:** 3031 Tisch Way, San Jose, CA 95128. **New York:** 205 E. 42nd St., New York, N.Y. 10017. **London:** IPC Business Press, Quadrant House, The Quadrant, Sutton Surrey, SM2 5AS, England.

Reprints of Mini-Micro Systems articles are available on a custom printing basis at reasonable prices in quantities of 500 or more. For an exact quote, contact Art Lehmann, Cahners Reprint Service, Cahners Plaza, 1350 E. Touhy Ave., Box 5080, Des Plaines, IL 60018. Phone (312)635-8800.

MINI-MICRO SYSTEMS/November 1983

SIMPLE.

Instant networking, independent of computer and peripheral brands.

Creating a micro and mini computer network has been costly and confusing. Communications hierarchy has prevented many types and various kinds of equipment from sharing information. Until now.

Introducing StationMate. One unit that joins mini computers, micro computers, terminals, and printers. It's transparent. So different brands and types of computers and peripherals can easily interface. StationMate allows you to construct a comprehensive communications network. *Inexpensively.*

Users can select the information they need from the unit they want. StationMate can

StationMate provides local area networking with XLAN™, the simple communications con-

only \$1,450.00. StationMate makes communications simple. *Incredibly.*

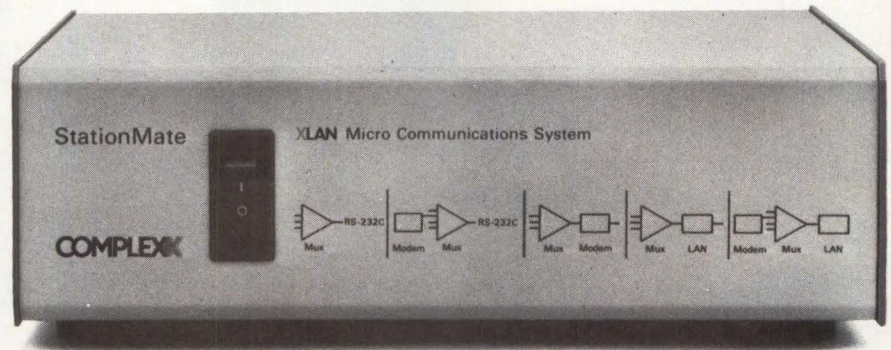

cept from Complexx. All you need is StationMate and an inexpensive shielded-pair cable. Besides local area net-

StationMate. The link you've been missing. See your local dealer or contact Complexx for the name

Teleprocessing

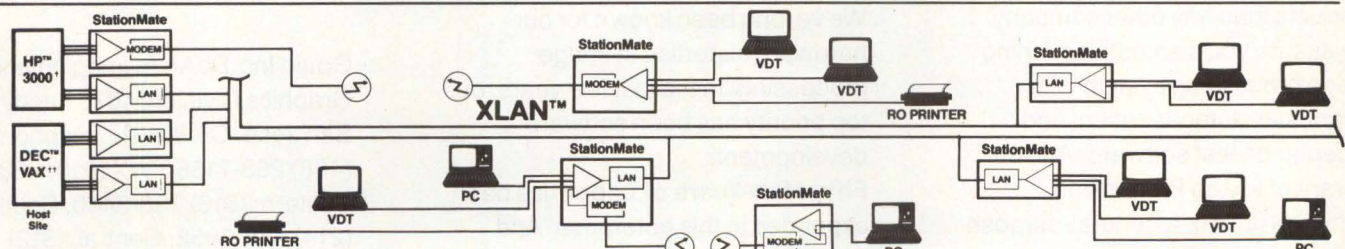
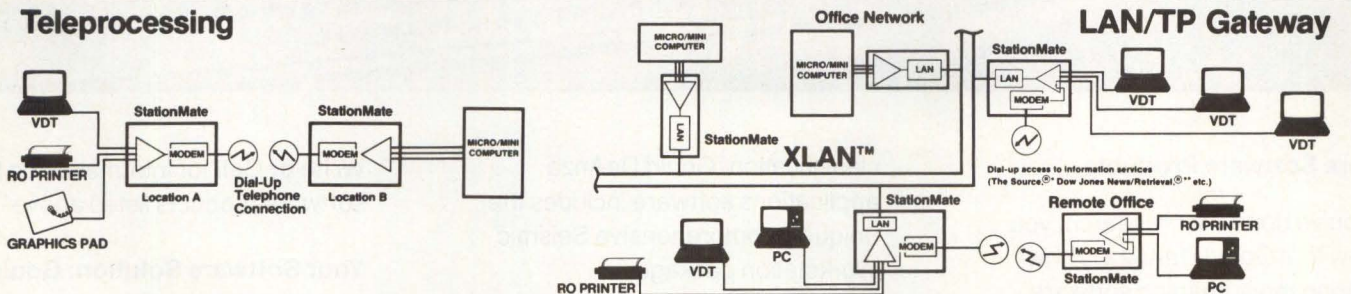

Local Networking

address any port in the network either by its assigned digital code or by its common identifying name. So everyone has access to all the local or remote computers, mass storage files, and peripheral devices connected in the network. *Immediately.*

working, StationMate permits access to remote workstations via an internal dial-up modem. And it serves as a gateway for teleprocessing access to all LAN resources. You couldn't get all of this in one unit. Until now. And the suggested retail price is

of the dealer or distributor nearest you. *Complexx Systems, Inc., 4930 Research Drive, Huntsville, AL 35805. 205/830-4310.*



*The Source is a registered trademark of the Source Telecomputing Company, a subsidiary of the Reader's Digest Association. **Dow Jones News/Retrieval is a registered trademark of Dow Jones & Company, Inc. †HP 3000 is a registered trademark of Hewlett Packard. ††DEC VAX is a registered trademark of Digital Equipment Corporation.

Gould Imaging Software

the End to a Tough Research Job.

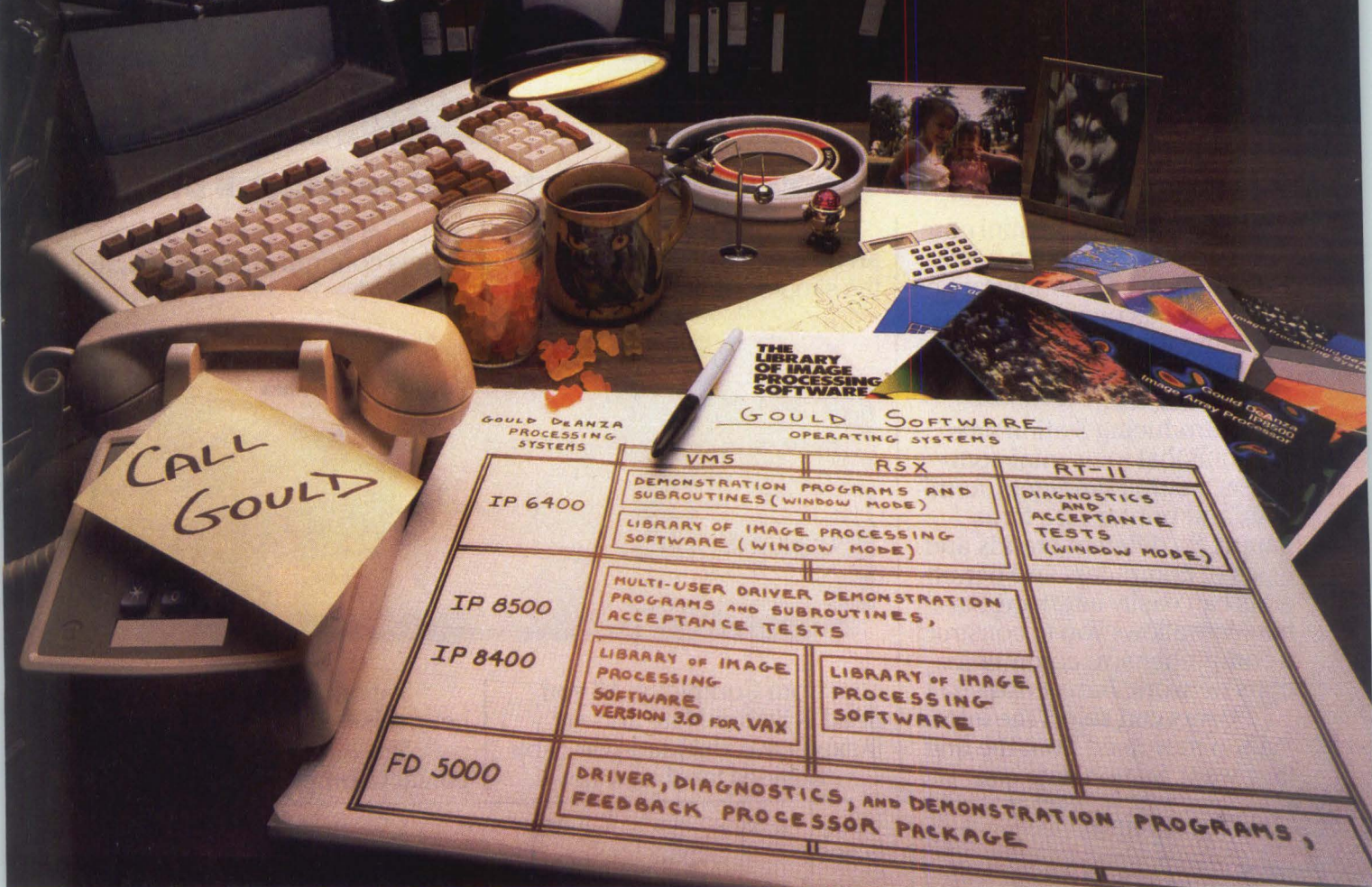

More Software Products

If you've done your research, you know that Gould DeAnza is now offering more imaging software products than any other company. We assure you a smoothly running image processing system with diagnostic, demonstration, and acceptance test software. And our Library of Image Processing Software (LIPS), a general-purpose package, will enhance any imaging application. LIPS version 3 carries Fast Fourier Transform programs as well as statistics and "training set acquisition" packages for Bayesian

classification. Gould DeAnza applications software includes the uniquely comprehensive Seismic Workstation package.

We've long been known for our hardware expertise in image processing. In the last few years, our top priority has been software development.

Fifty Man-Years of Labor has been expended in this enterprise. And that's just the beginning. We're going to continue offering you the most comprehensive, flexible, and sophisticated imaging software in the industry.

Write or Call for information on the software products listed above.

Your Software Solution: Gould.

Gould Inc. DeAnza Imaging and Graphics Division, 1870 Lundy Ave., San Jose, CA 95131. Telephone (408) 263-7155 TWX (910) 338-7656. Eastern: (516) 736-3440, Southwest: (214) 458-0052, Central: (312) 965-8110, Western: (408) 263-7155.

CIRCLE NO. 6 ON INQUIRY CARD

 **GOULD**
Electronics

Video display terminals: help or hazard?

The National Review Council (NRC), in a report released this summer, concludes that video display terminals (VDTs) do not apparently threaten operators' vision. However, the NRC indicates that terminal designs and operations as well as physical and psychological environments do contribute to job stress and associated operator complaints. Other similar studies, performed recently by the U.S. National Institute for Occupational Safety and Health (NIOSH), the Massachusetts Division of Occupational Hygiene, the Bureau of Radiological Health of the U. S. Food and Drug Administration and Canada's Department of Communications, have all found the VDT radiation is virtually undetectable and therefore not a health hazard.

Despite these assurances, VDT operators—the majority of whom are women—continue to complain about a wide range of physical and mental ailments such as eye, neck and back strains; miscarriages; birth defects; blurred vision; headaches; and fatigue. The NRC reasoned that VDT workers' comfort, performance and stress have been adversely affected in many cases by designers' and managers' failures to apply to equipment and jobs well-established principles of good design and work practices.

To combat these assertions, some companies have instituted ergonomic-driven terminal designs and corrective VDT user practices and skill programs. In terminal design, for example, most VDT units now incorporate tilt-and-swivel monitors, detachable keyboards, monitor-height adjustments, non-glare screens and eye-pleasing color phosphors and equipment. In corrective programs, relatively inexpensive and straightforward improved user practices call for frequent, short work breaks, simple physical exercises, improved lighting, worker education and management time-study cooperation. And such measures have resulted in 80 to 100 percent lower incidences of user problems.

Despite these improvements, though, many user support groups remain unconvinced. Such groups as Nine-to-Five (a national organization of women office workers), the National Association of Working Women and six state legislatures (MMS, October, Page 84) prefer mandatory regulations on VDT manufacture and use. Because many OEM and end user organizations have reacted slowly and indifferently to users' health-hazard accusations, these groups are asking for compulsory remedies such as rest periods, adjustable equipment, glare and heat reduction, eye examinations, periodic equipment maintenance and radiation shielding.

Further complicating the problems, says the NRC, is that VDT technology is evolving too quickly to justify specific numerical guidelines such as character size, viewing distance and luminance. It does suggest, though, that judicious use of acceptable guidelines would be helpful. What's needed, therefore, is for employees, employers, manufacturers and government agencies to band together for mutual benefits. With an estimated 10 million VDTs in use today and twice that number expected by 1985, operated by children and adolescents as well as by adults, answers, instead of rebuttals, to users' claims are needed.



George V. Kotelly
George V. Kotelly,
Editor-in-Chief

CAHNERS PUBLISHING COMPANY

Cahners Magazine Division
publishes the following specialized
business magazines and directories:

Building/Construction Group

Brick & Clay Record
Building Design & Construction
Building Supply & Home Centers
Ceramic Industry
Construction Equipment
Professional Builder
Security Distributing & Marketing
Security World
Specifying Engineer

Foodservice Group

Foodservice Equipment Specialist
Hotels & Restaurants International
Restaurants & Institutions

Electronic/Computer Group

Business Computer Systems
EDN
Electronic Business
Electronic Packaging & Production
Mini-Micro Systems
Semiconductor International

Manufacturing Industries Group

Appliance Manufacturer
CPI Purchasing
Design News
Design News Directories
Modern Materials Handling
Packaging
Plastics World
Purchasing
Traffic Management
U.S. Industrial Directory

Fischer Medical Group

Emergency Medicine
The Journal of Cardiovascular
Medicine
Transitions-Medicine and the Aging
Process

Newsletter Division

Electronic Business Forecast
Plastic Business News
Buying Strategy Forecast
Early Warning Forecast
Transport (De)Regulation Report
Hazardous Materials Transportation
Oil Spill Intelligence Report
Tradeshow Week
Chain Marketing & Management

Cahners Exposition Group

is the largest producer, operator and
manager of trade and consumer shows
in the world . . . with over 100 shows,
6,000,000 square feet of exhibition
space and total annual attendance of
over three million.



CAHNERS
PUBLISHING COMPANY

221 Columbus Avenue
Boston, MA 02116
617/536-7780

ACCORDING TO OUR THIS IS IM



Since we first entered the Winchester market two years ago, we've accomplished many things our competition claimed were impossible.

It was impossible, they said, for a floppy disk company to make a significant dent in the highly competitive Winchester market.

We've not only made a dent, we're the second-largest company in the business, and we have the capacity in place to be first.

It was impossible to expand our production capacity from 0 to 60,000 drives a month practically overnight. But we did it.

It was impossible to sell Winchesters at

such a low cost. But last year our 500 series drives were introduced at under \$500, 30% under then-standard industry costs. And since then, we've led the industry to ever-lower costs on full and half-height drives.

It was impossible to produce and ship high-performance plated media drives in high volume at prices lower than most vendors are charging for oxide media drives. One of our competitors backed away from plated media because they couldn't buy enough of it to build drives in efficient quantities.

We solved that problem by building our

UR COMPETITION, POSSIBLE.



own plated media factory dedicated to plated media production in high volume. Because we make our own, our costs are low and we are independent of outside vendors for supply.

It was impossible for a start-up company to produce and ship a broad line of products: full and half-height drives, open and closed-loop, from 6.4 to 50 MB. But we've done it. With the help of one of the industry's best-funded R&D programs. And with our steady supply of plated media, we will soon be offering 5¼" drives that push Winchester technology to the limits of its

capacity. In high volume. At prices that are pure Tandon.

Impossible?

For our competition, yes.

But not for the Tandon Winchester Company.

TANDON WINCHESTER COMPANY.

Tandon
THE MOST SUCCESSFUL DRIVE
COMPANIES YOU EVER HEARD OF.

We've brought word processing to the big screen. **CIE TERMINALS**

A new company of
C. ITOH ELECTRONICS, INC.

If you have a multi-user word processing system with LEX/680, LEX 11 or Wordstar software, you can plug into the CIT-500 -- and enjoy the convenience of big screen word processing.

CIT-500's unique vertical monitor features a full page display with 64 line depth. So you can perform word processing and text editing functions faster and easier.

The user-friendly CIT-500 is easy on your body, too. Its fully ergonomic design features a terminal that tilts and swivels, a tiltable, detached keyboard, a non-glare screen and matted key caps.

And there's much more, like down-line loading of multiple character fonts, VT100/ANSI compatibility, and an intelligent printer port.

So plug your system into the low cost CIT-500. And experience word processing on the big screen.

To learn more, just write or call CIE Terminals. 2505 McCabe Way, Irvine, CA 92714-6297. (714) 660-1421. Call toll-free 1-800-854-5959. In California, call toll-free 1-800-432-3687.

CIT-500

CIRCLE NO. 9 ON INQUIRY CARD

Breakpoints

JANOME INTRODUCES 3-INCH MICROFLOPPY FOR U.S. MARKET

Janome Sewing Machine Co. Ltd., Tokyo, will introduce a smaller version of the Hitachi/Maxell/Matsushita-style 3-inch microfloppy disk drive. Like the Hitachi drive, the Janome MFD-80 is plug-compatible with the SA400 industry-standard 5¼-inch drive interface and transfers data at the same 250K-bit-per-second rate. It uses Maxell media, which stores 250K bytes per side and can be flipped over for a total of 500K bytes of storage per disk. The mechanics-only version of the Janome drive measures about 3.3 inches wide by 1.4 inches high, allowing as many as four MFD-80s to be placed vertically in the same space typically used by a full-sized 5¼-inch floppy drive. David Stoddard, designer of the Janome drive, says the control and drive electronics for all four can be installed behind the drives. The standard version of the Janome measures 3.6 by 1.6 by 6 inches. The MFD-80 normally uses 40 tracks per side but has spare-track provisions that allow as many as 48 tracks per side to be used, thus increasing maximum storage to 600K bytes per disk. Evaluation quantities are expected to be shipped in January, and the drives are expected to be priced at \$125 in lots of 10,000.

SOFTECH MICROSYSTEMS TO INTRODUCE LAN FOR P-SYSTEM

Softech Microsystems, San Diego, a subsidiary of Softech Inc., should introduce the Liaison local-area-network software this month for the p-System. Liaison is expected to consist of system software and application products but is adaptable to a variety of hardware and network media. The initial adaptation will be on Omninet. System software will include the p-System operating system enhanced with networking, a disk server, a print server and a media-adaptation kit. Five application packages initially available will provide database, word-processing, electronic-mail, executive calendar and spreadsheet capabilities.

16032-BASED MULTIUSER SYSTEMS RUN VAX PROGRAMS

Unidot Corp., Golden, Colo., will introduce two multiprocessor systems, the Accord and the Concord, that will use the demand-paged virtual-memory capability of the NSC16032 microprocessor to run unaltered VAX superminicomputer programs with 1M byte or 2M bytes of RAM instead of the 4M to 6M bytes such programs require on VAX systems. The Accord system includes one 16032 processor board with on-board cache, an 80M-byte Winchester drive with DMA controller and 14M-byte cartridge-tape backup and 1M byte to 2M bytes of dynamic RAM. The Concord system adds a second identical processor board that acts as an intelligent slave dedicated to application programs. The systems run the UNIX-variant GENIX operating system at 10 MHz using a Multibus architecture. The microprocessor boards also have a 16081 floating-point processor, a 16082 memory-management unit, two serial ports and 8K bytes of static RAM cache memory. The \$14,950 Accord system supports 16 users, and the \$17,995 Concord system supports 32 or more users. Volume shipments are expected in January.

BLUEBIRD SOFTWARE PACKAGE TO RUN ON IBM PC

Bluebird Systems, Carlsbad, Calif., will this month demonstrate its proprietary SuperDOS operating system with Business BASIC compiler on the IBM PC. The company has developed the system to provide multiuser application packages for small business microcomputer systems. Bluebird, founded in 1982 by Hal Tilbury after his original venture, Compusource, was acquired by Electronic Data Systems, has targeted Data General Corp. OEMs with its software package, claimed to be available nationwide through more than 50 OEMs. Bluebird reportedly has more than 150 installed systems. The company plans to adapt the software for use on other popular microcomputers in addition to the PC.

Breakpoints

Comdex preview: Lear Siegler Inc.'s Data Products division, Anaheim, Calif., **plans to demonstrate for the first time its new ADM 12 ergonomic terminal** at this month's Comdex show. The new unit features 16 programmable function keys, user-definable scrolling regions for a 158-column-by-24-line horizontal format, an 80-column-by-48-line vertical format and six programmable editing keys. The unit will be priced at \$895. Integral 300- or 1200-baud modems and a graphics board will be optional for both the ADM 11 and ADM 12 terminals.

Qume Corp., San Jose, Calif., **plans to unveil its first graphics terminal**, the QVT211GX. The unit is said to be priced at \$1,295.

Diablo Systems Inc., Hayward, Calif., **expects to enter the multimode serial matrix printer market** with the introduction of the 11CQ version of its Series 11 printer. The printer produces draft-quality characters at 100 characters per second (cps) and correspondence quality at 30 cps. The 80-column printer will employ a nine-pin print head and will retail for \$749. Diablo will also reportedly show a CQ version of the series 32 printer off the show floor. The 32CQ is expected to have print modes of 150 cps for draft quality and 60 cps for correspondence quality.

The 20-cps daisy-wheel Letterpro 20 printer (less than \$1,000 retail) **expected from Qume Corp.**, San Jose, Calif., **is Qume's lowest priced printer to date.** Qume will also display its new Superstrike print wheels and ribbons, its first line of supplies not intended for Qume printers. The first Superstrike products will be targeted at Diablo daisy-wheel modems.

Mannesmann Tally Corp., Kent, Wash., expects to announce its new MT-440L series matrix printer in November and to demonstrate it publicly for the first time at Comdex. Priced at \$2,695, the unit features 400-cps printing in a draft mode and 100-cps printing in correspondence quality. The printer features an enhanced slew rate, special tabbing to move the print head as fast as 650 cps when covering blank spaces, optional four-color printing and a cut-sheet feeder.

New **Printronix Inc.** printer models are expected. The Irvine, Calif., company's MVP 150B printer-plotter is one of the first matrix line printers with plug-compatible interfaces for popular microcomputers such as the IBM PC and the Victor 9000. The tabletop unit features six operator-selectable print modes. Printronix will also add two models to its P series of line printers, the P300XQ and P600XQ. Printronix expects to lower the matrix line printers' noise level to 55 dBA. The new printers also feature multiple print modes with maximum speed of 400 and 800 lpm, respectively.

Trilog Inc., Irvine, Calif., should unveil its second-generation four-color matrix line printer, the Colorplot II series. At \$6,900 for a 300-lpm version, the printer's price is almost half that of its predecessor, the Colorplot I. The printer comes with standard black or four-color ribbons.

Comrex International Inc., Torrance, Calif., is scheduled to introduce the ComRiter III daisy-wheel printer. The unit will feature a 132-column print line and 23-cps speed. Priced at less than \$1,000 retail, it will offer bidirectional printing and two-color capabilities. Comrex also plans to introduce an automatic cut-sheet feeder for less than \$250 for the printer soon.

Vertex Corp. expects to add a 100M-byte unit to its line of high-capacity, 5¼-inch Winchester disk drives. The unit uses the same number of heads and platters as does Vertex's current 70M-byte model. The drive will implement the Seagate ST-412HP

SOFTCON.TM THE MOST IMPORTANT COMPUTER INDUSTRY EVENT IN 1984.

Everyone is talking about Softcon, the international conference and tradefair for the software industry.

It's the first computer show where the really important new products aren't lost in a sea of hardware knock-offs and look-alikes.

All of the biggest names in software will be there—plus some remarkable ones you haven't heard of yet. Companies from around the world will debut the newest, most innovative developments in software. From Abacus to Zyword.

At Softcon, nearly 1000 exhibits will showcase more than 12,000 software products for professional, home, education, entertainment, office, business, industrial and vertical-market consumers. Hundreds of landmark products will be shown for the first time anywhere at Softcon.

More than 60 seminars, panel discussions, forums and workshops will explore the latest trends in software retailing, publishing, standards and trends.

Softcon is so extensive that it has already become the third largest computer show. Ever.

Softcon is open to the trade only. If your company sells computers, software, office products, consumer electronics or books; if you're a volume software buyer (systems house, Fortune 1300 executive, data processing director, government buyer, school purchaser or consultant); or if you write or market software, you can't afford to miss Softcon.

It all happens in one of America's most delightful cities, during the exciting season of Mardi Gras.

For more information or to make your reservation right away, call 800-841-7000 (outside of Mass.), or 617-739-2000 (inside of Mass.). Or write Northeast Expositions, 822 Boylston Street, Chestnut Hill, MA 02167.

Softcon is produced by Northeast Expositions Inc., nationwide producers of the National Computer Shows, Applefest, CPM '83 and PC '83, 822 Boylston Street, Chestnut Hill, Massachusetts 02167 617-739-2000 (inside of Mass.) 800-841-7000 (outside of Mass.) Softcon is a trademark of Northeast Expositions



The International Conference
and Tradefair for the Software Industry
Tuesday-Thursday, February 21-23, 1984
La Superdome, New Orleans

Name _____

Title _____

Company _____

Address _____

City _____ State _____ Zip _____

Telephone _____

- Send me the complete attendee registration kit
 Send information on exhibiting at Softcon

CIRCLE NO. 10 ON INQUIRY CARD

Your relation to software:

- Retailer
 Systems house
 Publisher
 Developer
 Consultant
 School system
 Government
 MIS professional
 DP professional
 Marketer
 Distributor
 Financial institution
 Other _____

SHAPE UP IN THE SHAKEOUT.

When the shakeout in microcomputer boards and systems is over where will you be? To grow and prosper, you should be aligned with Advanced Digital Corporation: a technological leader in S-100 multi-user, multiprocessor system solutions.

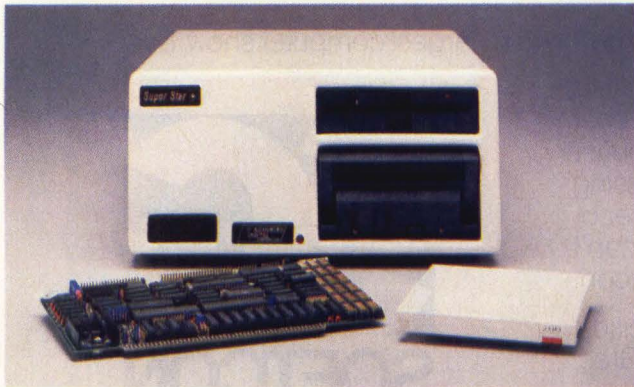

SUPER SIX. The world's first and only 6 MHz Z80* S-100 Single Board Computer. Available with TurboDOS* and 128K of RAM, it is the only S-100 board that supports CP/M* 3.0 (plus) in a banked mode, and TurboDOS 1.3.

SUPER QUAD. The single board computer that replaces traditional multi-board S-100 computers at a fraction of the cost. SUPER QUAD contains 64K bytes of memory, has 4 MHz Z80 CPU, and runs with CP/M, MP/M,* CP/NET* and TurboDOS.

*Z80 is a trademark of Zilog, Inc.
TurboDOS is a trademarked product of Software 2000, Inc.
CP/M is a registered trademark, and MP/M and CP/NET are trademarks of Digital Research, Inc.
SUPER SIX, SUPER QUAD, SUPER SLAVE, SUPER STAR, and SUPER SYSTEM II are trademarks of Advanced Digital Corporation.

SUPER SLAVE. For multi-user, multi-processing; a powerful single board slave processor, featuring 64/128K of banked switched RAM. Multiple slaves in a system give dedicated 4/6 MHz Z80 CPU to each user.

HARD DISK CONTROLLER. Micro-processor based, compact S-100 board with ECC. All buffers and receivers/drivers included for operating up to 4 drives (8" or 5¼", soft or hard sectored).

SUPER 186. The world's first 16-bit, S-100 single board computer.

In addition to boards, we offer advanced micro systems. Our SUPER SYSTEM II and SUPER STAR multi-user, multiprocessor micros are class leaders. SUPER SYSTEM II with an S-100 single board computer, expandable to 10 users; SUPER STAR with the industry's first 5 MB fixed/removable hard disk.

Best of all, we offer you third party maintenance and support, extremely competitive prices, terms, and an unconditional one-year warranty. Get yourself in shape for the shakeout with our S-100 line. Call or write Advanced Digital Corporation, 5432 Production Drive, Huntington Beach, California 92649; (714) 891-4004. TLX: 183210 ADVANCED HTBH.



See us at Comdex, booth numbers 378 and 481.

Breakpoints

interface introduced in September. Like the enhanced small disk interface pushed by Maxtor Corp., the ST-412HP interface will achieve a transfer rate of 10M bits per second. The Seagate interface continues to gather the support of drive manufacturers, as Vertex and Computer Memories Inc. join Seagate Technology, Tandon Corp., Atasi Corp., Priam Corp., Western Digital Corp. and Adaptec Inc. in supporting the interface.

Seagate Technology has announced an agreement in principle to acquire privately held high-end 5¼-inch disk drive manufacturer Atasi Corp., San Jose, Calif. The agreement, subject to approval of the boards of both companies and Seagate shareholders, calls for an exchange of 7.2 million shares of Seagate stock—estimated to be worth about \$130 million—to Atasi shareholders. Seagate is the acknowledged frontrunner in the low-end 5¼-inch Winchester market. Through the acquisition of Atasi, Seagate will gain a major footing in the high-end market with the company that was the first to ship drives with capacities of 30M bytes or more. A Seagate spokesman says no definitive agreement has yet been signed to determine if Atasi will continue to operate as a separate entity or as a part of Seagate, nor the future role of Atasi management. The spokesman says the final agreement may be approved by Comdex. In addition, the agreement will not change Seagate's plans to introduce its own 50M-byte drive at the Comdex show this month.

Seagate plans to introduce its second half-height, 5¼-inch Winchester drive, the ST-212. It will store 12M bytes on one platter through the use of four read/write heads, two per side. As a result, the drive will feature a 65-msec. average access time, one of the fastest for half-height drives. The drive should be available in evaluation units in December, and production is slated to begin in the first quarter of 1984. The drive will be priced at \$1,265 in single-unit quantities and \$690 in quantities of 1,000.

The CS/100 local-area network communications server scheduled to be announced by **Bridge Communications Inc.,** Cupertino, Calif., aims at low-cost Ethernet capability for diverse small office computers and personal computers. A CS/100 with four RS232 ports is priced at \$3,900. A server with 10 ports is \$4,900. The 68000-based CS/100 is a single-board version of Bridge's CS/1, which connects as many as 32 devices. The CS/100 is compatible with all other Bridge products. It supports the IEEE 802.3 specification, and the Xerox Network System protocols, which use levels three, four and five of the International Standards Organization model. An optional IEEE 488 interface provides a link to minicomputers. Data transfers reach 125 packets per second for interactive applications. File-transfer rate is 600K bits per second. Optional software enables file transfers between CP/M, MS-DOS, VMS, UNIX and other operating systems. Availability is set for January.

Innovative Software Inc., Overland Park, Kan., plans to announce a personal-computer spreadsheet/graphics, word-processing and database-management package that is said to provide extensive integration among the programs. Each of the three programs in the Smart Series can run on a standalone basis. Series of commands can be stored and run in sequence automatically. The stored commands can be linked to worksheets in the other programs. The user interface is through cursor movements to a command list at the bottom of the screen. Each program contains a calculator for sine, cosine, binary conversion and other functions. Tentative price is \$475 to \$695 per program. The system initially runs under PC-DOS. Memory required is 128K bytes.

Officials at **Digital Microsystems,** Oakland, Calif., believe the most economical way to provide IBM PC networking is through a master/slave polling scheme with the company's DMS-816 IBM PC-compatible, disk-less workstations and DMS-3/501 master station. The company plans to introduce its network at Comdex. The \$1,695

Breakpoints

workstations connect to the \$6,500 master station as fast as 500K bps through RS422 ports and twisted-pair or flat-ribbon cabling. The network supports as many as 32 users. The 8086-based DMS-816 has 256K bytes of RAM, expandable to 512K bytes, and a 12-inch display. The DMS-816 also incorporates a Z80A for CP/M applications. The DMS-3/501 master station has a 15M-byte hard disk drive, a 640K-byte floppy drive and a 9-inch screen. The Z80A-based master station can also run CP/M. January availability is planned.

DY-4 Systems, Inc., Ottawa, should announce support of MS-DOS and UNIX on its Dynasty network of disk-based and disk-less workstations, in addition to its current CP/M support. The network uses the Corvus Omninet physical link. The company says performance is speedy because file-server disks are shared, rather than segmented. The network is targeted for large installations in universities, government and business environments. List price of a typical 32-user mixed system with a 20M-byte file server and a printer server would be about \$90,000.

Comdex will be the site for **Incoment's** introduction of its Elite distributed-processing and communications computer system. The Ventura, Calif., company describes the product as a two-board, multiuser desktop package that creates a standalone system or an intelligent node in a network. The Elite package will include a microprocessor, 512K bytes of RAM, expandable to 3M bytes, four parallel interface ports and four RS232 communications ports. Single-unit price will be \$7,400.

TECHFILES: A quick look at industry developments

Mini files: With its goal a complete 32-bit minicomputer line, **Digital Equipment Corp. is introducing two low-end VAX products**, the VAX-11/725 and the MicroVAX I. The VAX-11/725 uses an 11/730 CPU repackaged for an open-office environment and designed to fit under a desk. Its 8-inch RC25 Winchester disk drive stores 52M bytes of formatted data, half fixed and half removable. The Unibus-based system supports as much as 3M bytes of main memory and interfaces with Ethernet and DECnet. The VAX-11/725 ranges from \$24,950 to \$36,800, depending on configuration. The one- to four-user MicroVAX I is the first of a range of forthcoming smaller VAXs. Measuring 25 inches deep by 19 inches high by 6 inches wide, the Q-bus-based MicroVAX I will run VAX-11/780, 11/750 or 11/730 programs on its partially very-large-scale-integration-implemented architecture. A system with two 400K-byte 5¼-inch floppies, a 10M-byte Winchester and 512K bytes of RAM will sell for \$13,880 or \$16,985 with a 28M-byte Winchester and 1M byte of RAM. A disk-less rack-mount version will be \$9,995. The MicroVAX I is expected to be shipped in the first half of 1984....DEC is also reportedly planning the future release of a relational database-management system that will be available next year for the VAX line.

Printer files: General Electric Co. has completed negotiations to sell its printer products division, the Data Communication Products Department in Waynesboro, Va., to a group that includes management of the Waynesboro facility and private investors. The company will be called Genicom Corp. There are reportedly no plans to discontinue any GE printer lines, including those announced products not yet in production such as the 4000 series of matrix line printers....**Color ink-jet fans are talking about the potential of several experimental "bubble-jet" printers** being developed in Japan. A Canon prototype reportedly employs 512 jets—128 jets for each of four colors. Resolution is said to be 300 dots per inch (dpi), with groups of 16 dots in a pattern to form super-pixels that will appear in a nearly unlimited variety of shades. Other manufacturers are reportedly working on ink-jet technologies that could produce near-photographic color output at a resolution approaching 1,000 dpi....**Iquad Co., Locust**

A SURE WINNER.

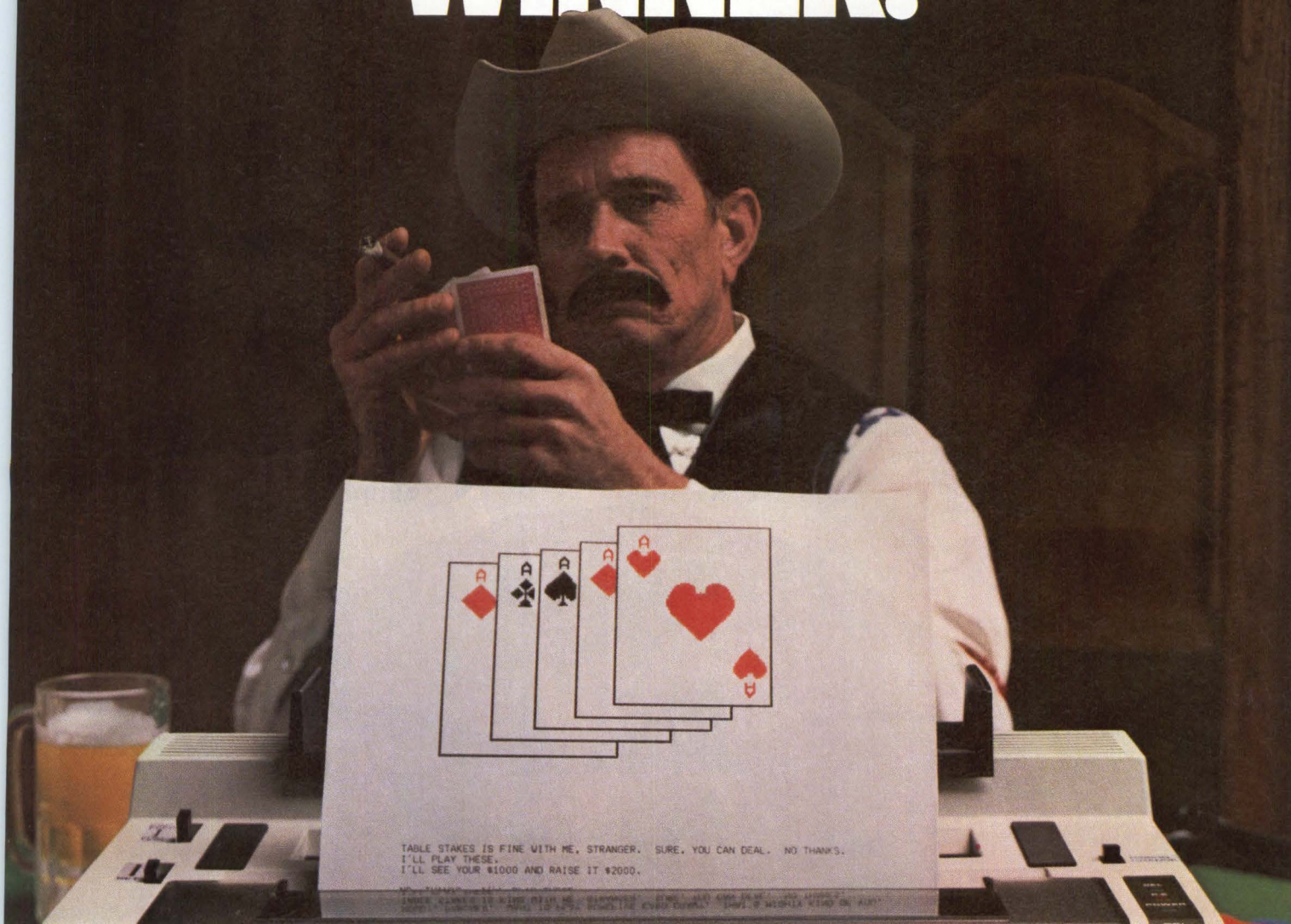

The new C. Itoh 8600 Serial Matrix Printer is clearly a hands down winner. For unlike others that offer graphics only as a high-priced option (if at all), the 8600 comes with built-in graphics at no extra cost. Graphics with even better resolution than many graphics plotters offer.

The 8600 also includes variable speed printing, with three task-specific speeds:

- 180 cps for Data Processing/Rough Draft
- 90 cps for High Resolution Graphics
- 60 cps for Near-Letter Quality (NLQ) Output

Other features offered standard with the 8600 include automatic vertical/horizontal tabbing and variable forms length with 6-channel electronic vertical formatting.

Paper feed is bi-directional cut sheet or optional tractor feed.

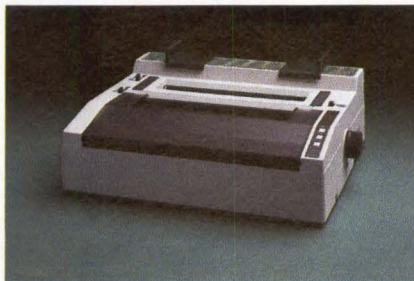

Head-to-platen distance can be easily adjustable.

For greater reliability, our print head features friction-free synthetic-ruby bearing surfaces to maintain the highest print quality throughout its long life. And use of heavy duty castings and precision stepper motor ensure lasting and accurate performance.

So put your money on C. Itoh's 8600 Matrix Printer. It's the best deal in the industry. For more information, contact C. Itoh Electronics, Inc., 5301 Beethoven Street, Los Angeles, California 90066. (213) 306-6700.

See us at Comdex Booth #2620.

C. ITOH ELECTRONICS
A World of Quality

CIRCLE NO. 11 ON INQUIRY CARD

The North Star ADVANTAGE offers networking.

The North Star ADVANTAGE is designed for outstanding ease of use—to allow the successful introduction of microcomputers to your business. The ADVANTAGE also has the power and flexibility to provide the increasing performance you will demand as your automation needs increase—including networking.

A North Star ADVANTAGE can start as a single, stand-alone desktop computer to provide you with today's most powerful business capabilities. When your needs outgrow the single system, NorthNet™ lets you gradually expand up to 64 interconnected workstations. NorthNet is the only complete local area network available from a single manufacturer that can evolve from a single workstation. And it is simple to install.

ADVANTAGE power on your desktop

The ADVANTAGE computer is the only system to offer combined 8 bit and 16 bit processing power, high resolution graphics, and up to 15Mb hard disk in one integrated package. And you have a wide choice of powerful software: CP/M®, MS™-DOS and North Star's Total Business Solutions. Combine our easy-to-use applications software with our presentation-quality graphics capabilities and you have unmatched power at your fingertips.

Solutions

Every North Star ADVANTAGE is a total business solution. And a full-service North Star dealer

can provide you with the training, service and even custom software to assure the solution is tailored to your business.

In short, the ADVANTAGE is the simple and powerful computer solution for your growing business.

You can discover North Star's simply powerful solutions at more than 1,000 computer stores and systems houses nationwide. Call 800-722-STAR for the location nearest you, or write North Star Computers, Inc., 14440 Catalina Street, San Leandro, CA 94577.

NorthStar™
Simply powerful solutions.

See us at Comdex/ Fall 83,
Booth #2566.



**National ON-SITE
and CARRY-IN service
is available through
M/A/I/Sorbus Service Division.**

CP/M is a registered trademark of Digital Research Inc.
MS-DOS is a trademark of MicroSoft, Inc.
The North Star logo, tagline and NorthNet are either trademarks
or registered trademarks of North Star Computers, Inc. © 1983.

**Special OEM incentives.
Call our OEM Coordinator
at (415) 357-8500.**

Breakpoints

Valley, N.Y., is reportedly developing a high-speed daisy-wheel printer. Iquad, which recently went public, is said to have a proprietary technology that could produce speeds as high as 90 characters per second. Observers suggest the company's first product could retail for less than \$2,000.

Micro files: The fortunes of **Fortune Systems Corp.** have not been too bright recently. The company has been frequently lumped with troubled microcomputer manufacturers, and its stock price has tumbled to far less than the \$22 it was last spring. Recently, **founder and chief executive officer Gary Friedman resigned,** reportedly at the request of the board, on the same day that the company called a press conference to define Fortune's place in the market and to introduce some software products. Company officials claim those products will correct some previous products' shortcomings. Friedman cites management-style differences in parting company with Fortune. The company named David Caplan, who Friedman hired just three months before as vice president of research, to succeed Friedman as acting chief executive officer. Caplan disclosed that a search for a new president has been under way for a year because Friedman was expected to be promoted to chairman. As a result, **a permanent successor is likely to be installed soon.** Both Friedman and Fortune board member Tim Pennington of venture capital company Brentwood Associates, Los Angeles, describe the parting as "friendly."...International Resource Development, a Norwalk, Conn., market research company, hints that **AT&T may be planning to introduce a 32-bit microcomputer system based on the Western Electric Bellmac microprocessor and running Bell Laboratories' UNIX.** The AT&T microcomputer is said to be aimed directly at the IBM PC market. An MS-DOS look-alike operating system for the AT&T system could be secretly under development at Microsoft Corp....**A new DEC Rainbow users group reportedly has quietly started at, of all places, IBM Corp.'s PC headquarters** in Boca Raton, Fla. One reason the IBM employees may prefer the Rainbow over the PC is the Rainbow's superior graphics capabilities....List price of the **Direct Inc.** IBM PC-compatible computer that also emulates VT100 and Hewlett-Packard Co. terminals is \$3,995 not \$23,995 as was printed in the September MMS Breakpoints section.

Random disk files: **3M** is the latest manufacturer of 8-inch disk drives to discover its market window shattered by increased competition from the exploding 5¼-inch market. The company has sold its disk drive operations to Disc Tech One Inc., a Santa Barbara, Calif., manufacturer of 14-inch drives. 3M realized very little profit from its 8-inch drive production line in Camarillo, Calif. That line has manufactured 10M-, 20M- and 60M-byte, 8-inch drives since 1981. Despite the sale, no 3M employees in Camarillo lost their jobs; they were reassigned to 3M's thriving data-cartridge production at the same plant. Disc Tech One expects to announce some enhancements to the 3M line at this month's Comdex show. Shugart Corp. recently dropped its SA1100 line of low-end 8-inch Winchester, and major suppliers such as BASF Systems Corp. and Siemens Corp. have also dropped their 8-inch Winchester lines. **Iomega Corp.** plans to introduce its 5¼-inch form factor drive at this month's Comdex show. After signing a second-source manufacturing agreement with SCI Systems Inc., Huntsville, Ala., for the drive, Iomega has added the weight of flexible media giant Verbatim Corp. to second-source the media.

Notes from overseas: A few months back, France's **Thomson CSF** began manufacturing the 32:16 systems it had written into its contract with **Fortune Systems Corp.** Thomson officials say the company is setting up a maximum production capacity of 600 units a month. However, its output at the time of the recent Sicob show in Paris—three months after bringing the project in-house—did not come near that goal. However, Thomson hopes it will be making 300 units a month by January. The

Breakpoints

installed base is reported to be around 700 systems, sold by both Thomson's dealers and its direct sales force.

Across the English Channel, Fortune's nemesis, Convergent Technologies Inc., has apparently scored another of its famous OEM deals. In a first, Britain's mighty GEC Plc. says it wants to be a serious contender in the commercial market and sees the new Convergent N-GEN as its entry ticket. At press time, the three-way contract between Convergent, GEC and GEC's American subsidiary, A.B. Dick, was still reportedly unsigned, but GEC officials were treating the pact as a fait accompli, and Convergent was figuring its value around \$150 million to \$160 million over three years, with \$40 million in the first year. No one, however, is willing to estimate how much will go through A.B. Dick and how much through GEC's new office-automation efforts, GEC Information Systems Ltd. GEC's office-automation product line promises to be diversified: the company intends to add telex, teletext, a facsimile machine made by Panasonic and its own Intel-run Datacom 4000 executive telephone with an 80-by-24 screen and a keyboard, running via interfaces to the GEC 4000 mini. The Convergent unit, however, is the company's standalone word-processing-oriented microcomputer/workstation/terminal/personal computer. GEC reportedly hasn't ruled out selling the system through both dealer and retail channels. Coupled with the Convergent buy is GEC's decision to try to standardize all its vast holdings and products on UNIX.

Apparently, the home computer business is not the place to be. To the mammoth losses wracked up recently by **Atari, Texas Instruments Inc. and Mattel**, add the collapse of Britain's **Grundy Business Machines** and its one-time best seller, the Z80-based Newbrain, plus the forced bailout of Welsh microcomputer house **Dragon Data**. Dragon shareholders had to ante up \$3.75 million in emergency loans to tide the company over until Christmas and save its \$300 Z80 Dragon 32. **Plans are afoot in England for a buy-out of beleaguered Osborne Computer Corp.'s local subsidiary, Osborne Computer Corp. (U.K.) Ltd.** Osborne U.K. managing director Mike Healy is orchestrating the prospective move. He says unidentified production and distribution interests and a venture capitalist eyeing marketing and manufacturing rights on the Osborne equipment have approached him about spinning off the company. Although an Osborne subsidiary, 18-month-old Osborne U.K. is a separate legal entity whose only tie to Osborne is a supply line. Healy apparently feels there is still considerable market demand for an Osborne look-alike machine—at least in Britain, where Osborne U.K. has reportedly sold 8,000 to 9,000 units.

Hewlett-Packard Germany officials seem delighted the company deviated slightly from form and set up its new Business Development Group/Europe in Boeblingen, West Germany, rather than at HP European headquarters in Geneva, Switzerland. The chief of the new unit is also German, Klaus-Dieter Laidig, formerly general manager of the Boeblingen Manufacturing Division producing model 250 and 3000 computers. HP officials figure the move will improve their competitive position for a deeper penetration of their native market, which equals France's and Britain's.

Corvus Systems Inc., currently without any presence in Britain, is negotiating with its exclusive U.K. distributor **Keen Computers Ltd.** about setting up a joint marketing venture that would report to Corvus' European headquarters in Geneva, Switzerland. The talks are preliminary, but Corvus expects the new company, whose start-up should be around the first of the year, to be dubbed **Corvus Systems Ltd.**, with Corvus retaining majority ownership. To make it a success, the concern will have to add systems houses to Keen's dealer channels because the Corvus line is relatively unsophisticated.

Your IBM PC Deserves Davong MultiLink

You can do a lot with an IBM® PC, but think how much more you could do with access to the pooled resources of IBM PC users throughout your organization. You could share information and programs. Communicate with other users. Make use of larger data storage. And all at a lower cost per user.

With the Davong MultiLink™ local area network, up to 255 IBM PC and PC-XT computers can share hard disk resources.

Anyone in the network can access hard disks attached to specified "File Server" computers. Although a user can operate a File Server computer as if it were a stand-alone unit, others in the network can access the File Server's hard disk storage, subject to network control and security.

It's fast, too—2.5 megabit with node-to-node token passing taking only 28 microseconds. You'll hardly realize you're running on a network instead of your own hard disk.

Davong makes networking practical. A large network (200 users or more) costs less than \$700 per workstation. Ask about our OEM and quantity discounts. Available through more than 800 computer dealers. Don't you and your computer deserve Davong MultiLink?

™ Trademark ® Registered trademark
*Suggested Retail Price

See us at Comdex,
Las Vegas, Booth 174-277.



Davong Systems, Inc. □ 217 Humboldt Court □ Sunnyvale, California 94086
Telephone: (408) 734-4900

CIRCLE NO. 13 ON INQUIRY CARD

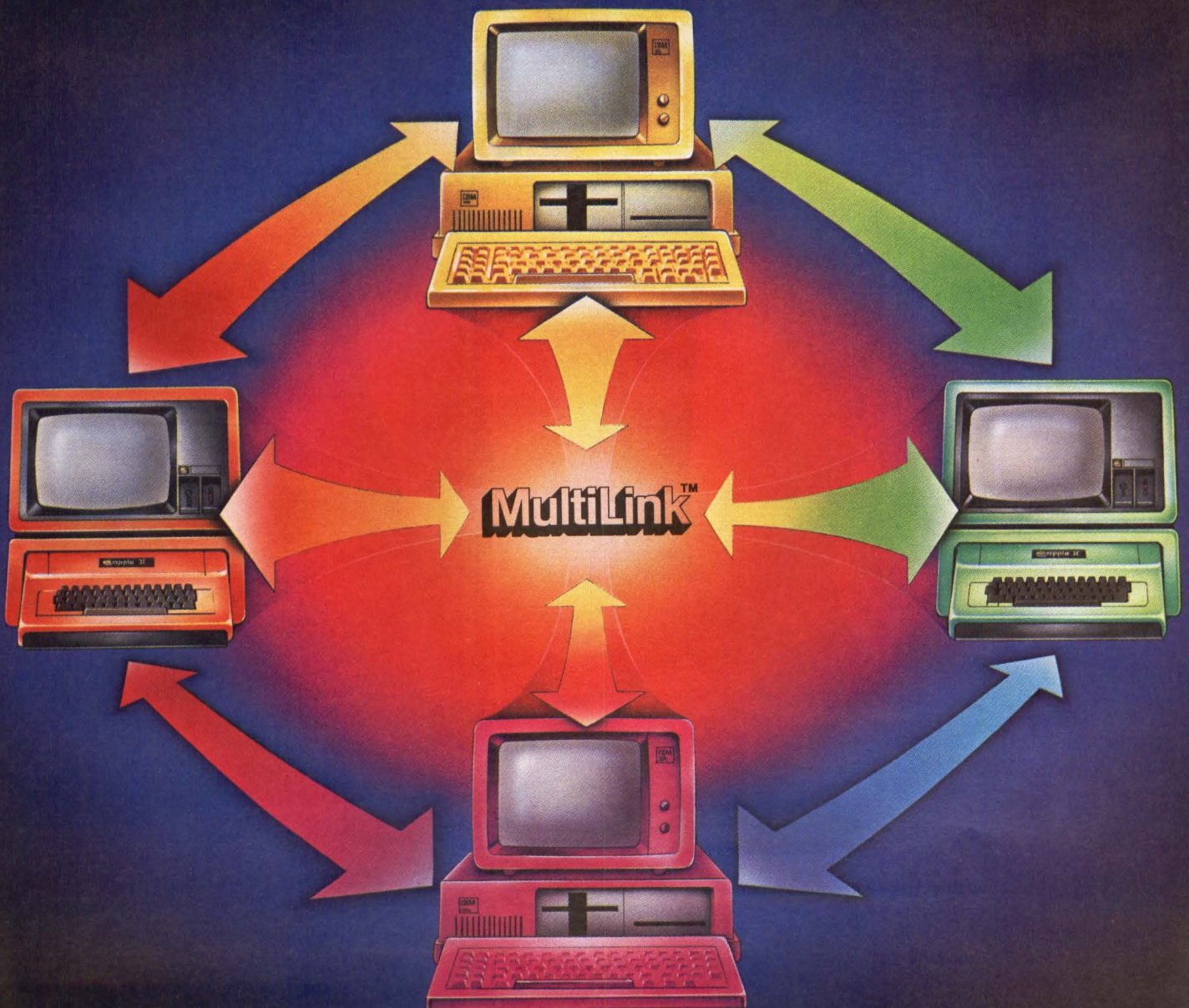

**DO YOU HAVE
THE DRIVE
TO SUCCEED?**

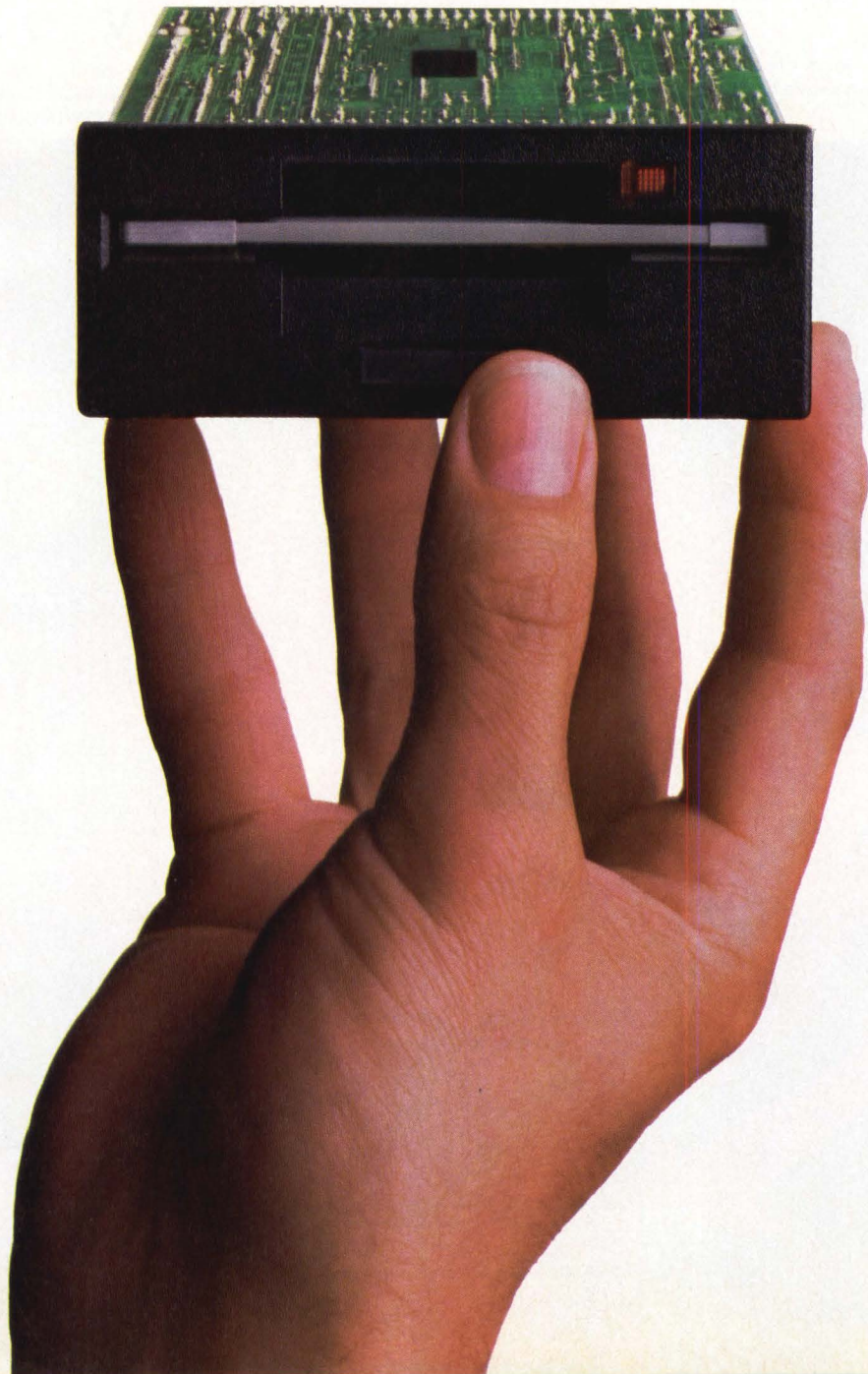

You do?

Good. So do we.

Shugart's 3.5" microfloppy drive. The SA300 by name.

And, considering where the personal/home/portable computer market is headed (betterfastercheapersmallerwithmorestorage), it's not a moment too soon.

It's also quite an achievement. One that allows you to engineer a wealth of advantages into smaller, more competitive systems.

Take the most obvious advantage, for instance.

Size. With the SA300 you can make your personal and home systems less imposing, more, well, personal. Our microfloppy takes up 75% less room than a standard sized Minifloppy.™

And it weighs just a tad over a pound. So your portable system can be more, you guessed it, portable, even with two drives in it.

Yet the SA300 still delivers 500 Kbytes in the single-sided version (1 Mbyte in the double-sided version) and uses less power, worst case, than an 8-watt night-light.

It's also so quiet, you can't hear it running unless you put your ear right down on top of it.

And with an MTBF of over 10,000 power-on hours, it should run for quite some time.

Then, of course, there's the not-so-small matter of the industry standard 3.5" microfloppy diskette.

Which offers a few important advantages of its own.

Like Minifloppy compatibility.

A track density that allows room for a generous upgrade path to more capacity.

And a hard shell plastic media cartridge for protection against the rigors of pocket and purse, with an automatic head access shutter as a last line of defense against little computer users who eat a lot of peanut butter and jelly.

Want to learn more?

We'll do a private Micro-floppy Workshop right in your office. And you'll have the chance to talk with media manufacturers and our own applications engineers about your plans for a big design win.

Call your local Shugart Sales Office to set it up. But do it soon.

You'd be amazed at what you can do with a little drive.



The 3.5" Micro-Cartridge provides maximum media protection.

Shugart

Right from the start.

See us at Comdex, Booth #3319.

Milpitas, CA (408) 263-2600, Costa Mesa, CA (714) 979-1935, Thousand Oaks, CA (805) 496-5388, Minneapolis, MN (612) 574-9750, Richardson, TX (214) 234-3568, Framingham, MA (617) 879-1700, Saddle Brook, NJ (201) 368-8445, Atlanta, GA (404) 955-8968, Toronto, ONT (416) 475-2655, Paris, France (1) 687-31-41, Munich, West Germany (089) 78-60-21, London, U.K. (44) 4862-24527. Hamilton/Avnet, authorized distributor.

CIRCLE NO. 14 ON INQUIRY CARD

THE DSD 880 WINCHESTER SYSTEM.

MADE THE WAY
DIGITAL WOULD MAKE IT.

EXCEPT DIGITAL
DOESN'T MAKE IT.

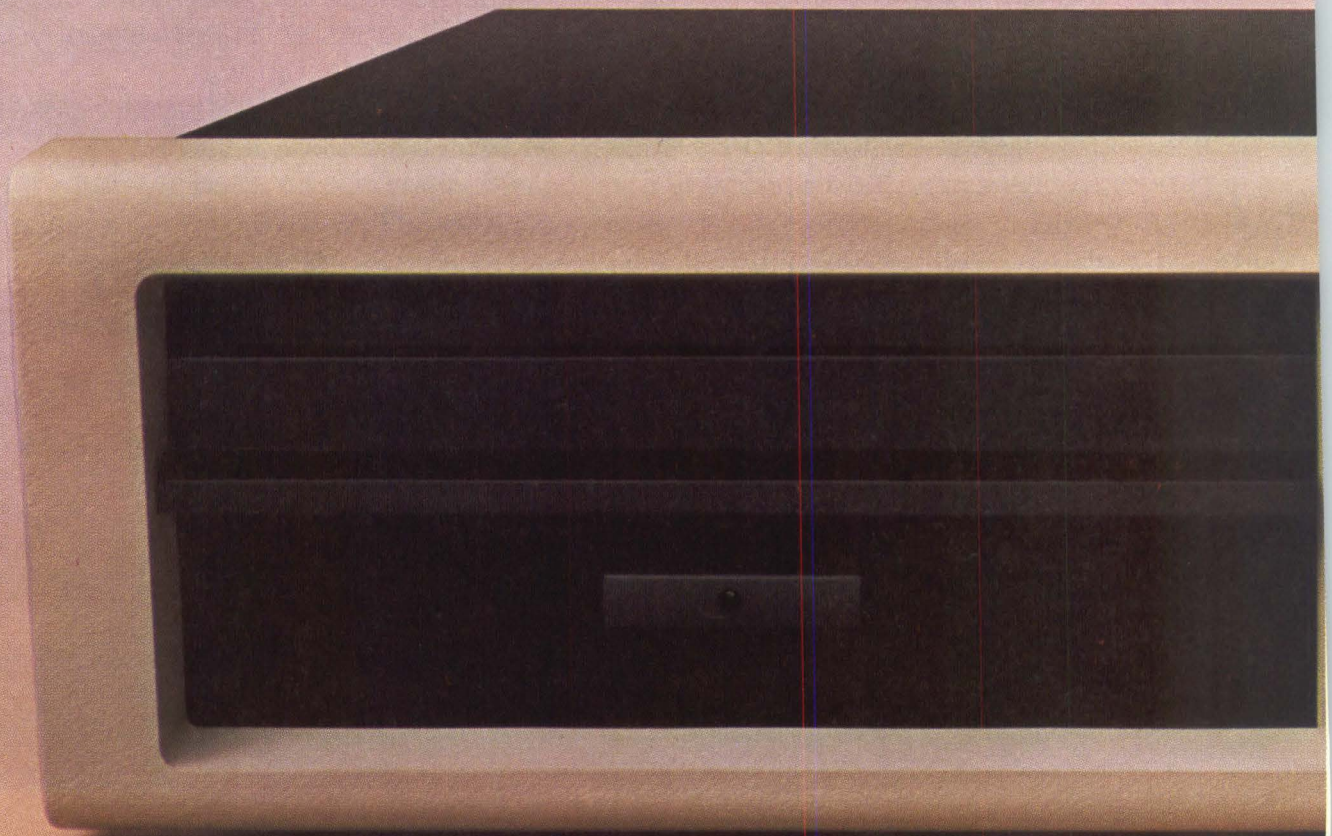

HyperDiagnostics, HyperService and Rapid Module Exchange are trademarks of Data Systems Design, Inc.
PDP is a registered trademark of Digital Equipment Corp.

©1983 Data Systems Design, Inc.



COMDEX/Fall '83

"See the StacPac™ storage and backplane modules and RAMTRAC™ line of MULTIBUS™
supermicro controller boards at booth 4333."

The people at Digital are a pretty smart bunch. They make some of the finest small computers in the world. So we like to think that if they were to make a new storage system like our 880 Winchester/Floppy, they'd do it the same way we did.

First of all, they'd make it extremely reliable with extensive testing and by using one of the most reliable storage technologies known, the Winchester.

Next, they'd offer it in different capacities, like 7.8, 20.8, and 31.2 megabytes, with a choice of .5 or 1 Mb floppy back-up, or none at all.

These different configurations would, of course, be fully compatible with Digital's LSI-11 and PDP -11 computers.

And the whole package would be extremely compact, just 5¼ inches high, so it would save space and fit in almost anywhere.

They might even add some on-board self-diagnostics, similar to our exclusive HyperDiagnostics™, so you could test, exercise, and debug without a CPU. And cut down on your service costs at the same time.

Maybe they'd even institute a module swap program, something like our Rapid Module Exchange™, which would be designed to get you

back up and running within twenty-four hours.

Finally, since this system would be so dependable, they'd be able to offer their extended service at a much lower price—much like we do with our own HyperService™, which goes into effect when the 90-day warranty expires and covers everything.

And then, as if it weren't good enough already, they'd offer this remarkable storage system at a lower cost per megabyte than any comparable system.

The fact is, though, Digital doesn't make anything like this.

Which is why we make the DSD 880 Winchester system to go with your Digital computer. And, why we make it the way we do.

Corporate Headquarters: 2241 Lundy Avenue, San Jose, CA 95131. Eastern Region Sales and Service: Norwood, MA, (617) 769-7620. Central Region Sales and Service: Dallas, TX, (214) 980-4884. Western Region Sales: Santa Clara, CA, (408) 727-3163.

DATA SYSTEMS DESIGN



INTERNATIONAL SALES: Australia 03/544 3444; Belgium and Luxembourg 02/7209038; Canada 416/625 1907; Denmark 02/63 22 33; Finland 90/88 50 11; France 03/411 5454; Hong Kong and Peoples Republic of China 03/696231; Israel 52-52444; Italy 02/4047648; Japan, Osaka 06/323 1707, Tokyo 03/345 1411; Netherlands 02977-22456; New Zealand 04/693 008; Norway 02/78 94 60; Singapore, Malaysia, and Indonesia 2241077; Spain 01/433 2412; Sweden 08/38 03 70; Switzerland 01/741 41 11; United Kingdom 7073/34774; West Germany and Austria 089/1204-0; Yugoslavia 61/263 261

CIRCLE NO. 15 ON INQUIRY CARD

NEW...

from DATARAM

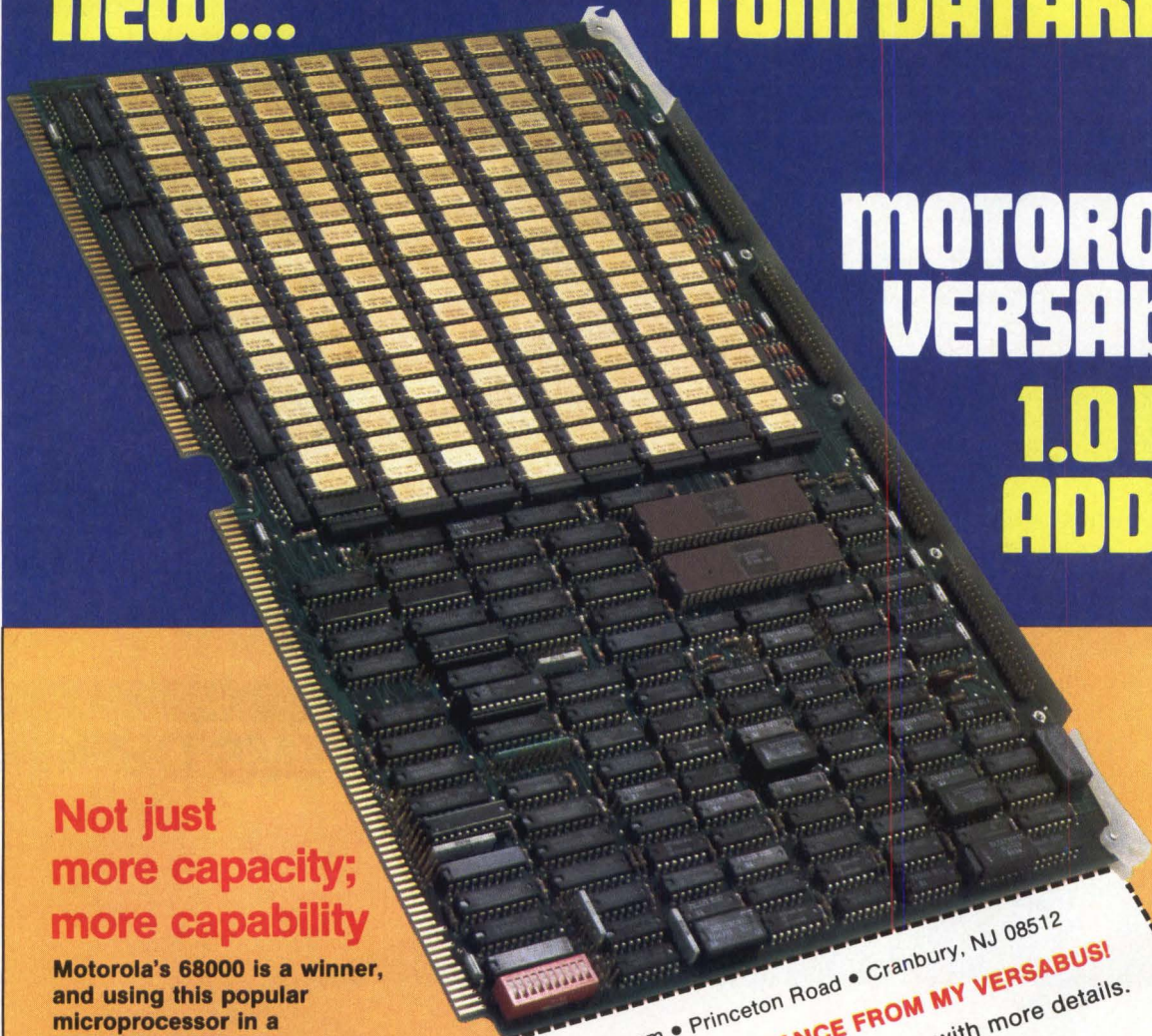

MOTOROLA VERSAbus 1.0 MB ADD-IN

Not just more capacity; more capability

Motorola's 68000 is a winner, and using this popular microprocessor in a VERSAbus/VERSAbord configuration is a smart move. Dataram's new single-board 1.0 MB DR-680 can make it even smarter. Increased single-board memory capacity means lower power, less space, higher reliability, and lower cost...and the DR-680 provides a lot more!

More speed: Ability to perform match cycles reduces access/cycle times by allowing immediate reading of data registers when adjacent words/bytes are accessed.

Advanced error handling: The DR-680 provides an on-board control and status register (CSR) which allows program control of ECC functions and contains the diagnostic information required for error analysis. The CSR can be read or written via the VERSAbus. Additionally, the DR-680 greatly increases reliability by performing error "sniffing" and error "scrubbing" during refresh operations.

Availability: Best of all, the 1.0 MB DR-680 is available now. And it comes with Dataram's standard one-year warranty.

For more information, send in the adjacent coupon or, for faster response, call Dataram today at (609) 799-0071.

VERSAbus and VERSAbord are registered trademarks of Motorola, Inc.

Dataram • Princeton Road • Cranbury, NJ 08512

MORE PERFORMANCE FROM MY VERSABUS!

- Sounds great. Please call me with more details.
- I'm interested. Send more information.

Name _____
Title _____
Company _____
Address _____ State _____ Zip _____
City _____
Telephone _____
MM1183

DATARAM

DATARAM CORPORATION
Princeton Road,
Cranbury, NJ 08512

Mini-Micro World

NEWS

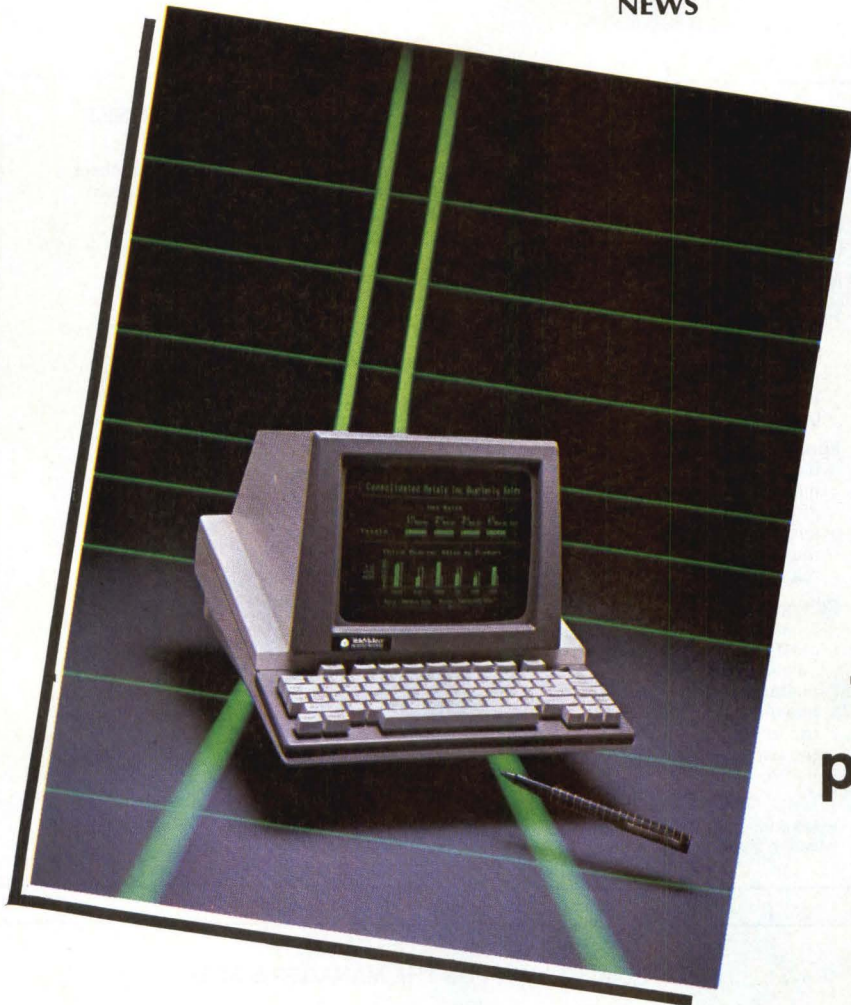

TeleVideo Systems Inc. hopes to push office-automation tools onto executives' desks with its \$469 Portable Terminal. The product can include an integral modem and telephone handset as options; thus, managers can bring it home and still access the corporate database.

TeleVideo's \$469 portable personal terminal challenges microcomputers

Bidding for priority space on the all-too-small executive desk is TeleVideo Systems Inc., Sunnyvale, Calif. This month, the company plans to unveil its Personal Terminal, the first in a series of what the company calls information stations aimed at challenging personal computers and smart telephones.

At an end-user price of \$469, the compact terminal has a 9-inch green phosphor screen, an integrated 75-key keyboard and two RS232 ports. It measures 9½ inches high by 12½ inches wide by 15 inches deep and weighs about 12 pounds. An integral modem and telephone handset are optional, as is a carrying case. The Personal Terminal's price just undercuts that of its

closest rival, Tymshare Inc.'s SCANSET terminal line. SCANSET prices start at \$495, not including an integrated modem that increases the price to \$649.

"There are a number of technologies and various strategies competing for very limited executive management desk space," observes Mark Siegel, executive vice president and general manager of TeleVideo's terminal division. "Certainly, personal computers are going to take a share of that desk space, but we believe some people are going to find they're spending too much money for functions they don't need at their workstation."

Siegel points to an emerging market for information-retrieval

applications requiring ties to a user's corporate database through direct connections and ties with outside sources or branch offices. "Input into the corporate computer system from this station will be occasional and casual," explains Siegel. "I, for example, do not want to do a spreadsheet and don't need a system on my desk that would allow me to do one. I would like, however, to be able to access the spreadsheets that have already been developed within the company."

To increase price and size economy, TeleVideo has traded off input capabilities. The Personal Terminal's undersized keyboard and 9-inch screen are clearly inappropriate for heavy data entry, editing

Mini-Micro World

NEWS

and computation. Craig Lynar, director of marketing for TeleVideo's CRT division, concedes that the keyboard is small in comparison to even a normal typewriter keyboard but asserts it is functional for the intended applications. "It is not a toy keyboard," he says. "It's rated at 10 million keystrokes per key [before failure], in comparison to some on the market rated at only 500,000."

The terminal provides seven double-width programmable function keys directly under the screen. Key functions are displayed on a status line. It has 14 shift-selectable functions. The screen displays 5 by 7-pixel ASCII characters on 24 lines at 80 or 40 columns per line (cpl).

The two standard RS232 ports enable the Personal Terminal to connect directly to a computer and a printer. The terminal operates in block mode and accepts most standard TeleVideo protocols. The company does not rule out the possibility that future Personal Terminal versions will emulate terminals from major systems suppliers, but Lynar believes many companies will buy the terminal in volumes that will make protocol converters very economical. TeleVideo plans to support the American National Standards Institute (ANSI) X3.64 standard, which is similar to the Digital Equipment Corp. VT100 specifications on many of its terminals.

TeleVideo's Personal Terminal is positioned as a low-cost alternative to more complex telephone workstations and personal computers. Its price is equivalent to units in the high end of autodial telephone equipment, but it is less expensive than most smart terminal and personal computer products that have data capabilities only, thus making it competitive enough to challenge some of those products on an executive's desk.

THE PERSONAL TERMINAL FACES OFF AGAINST SCANSET

	TeleVideo Personal Terminal	Tymshare Scanset
Physical specifications (height × width × depth, inches)	9½ × 12½ × 15	9½ × 10¼ × 14½
No. of keys on keyboard	75	69
CRT screen		
size (inches)	9	9
character font	5 × 7	5 × 9
ASCII characters	128	128
foreign characters	32	105
graphics characters	128	105
Functions		
block mode	yes	no
monitor mode	yes	no
direct cursor addressing	yes	yes
save cursor position	no	yes
read cursor address	no	yes
read terminal ID	yes	yes
Editing		
clear to end of line	yes	yes
clear to end of page	yes	yes
clear screen	yes	no
character insert/delete	yes	no
line insert/delete	yes	no
tab forward	yes	no
tab backward	yes	no

Source: TeleVideo Systems Inc.

Video attributes claimed by TeleVideo and not on the Tymshare model are reverse video, blinking, half intensity, blank, underline, and double wide and double high characters.

COMPETITION FOR THE MANAGER'S DESK

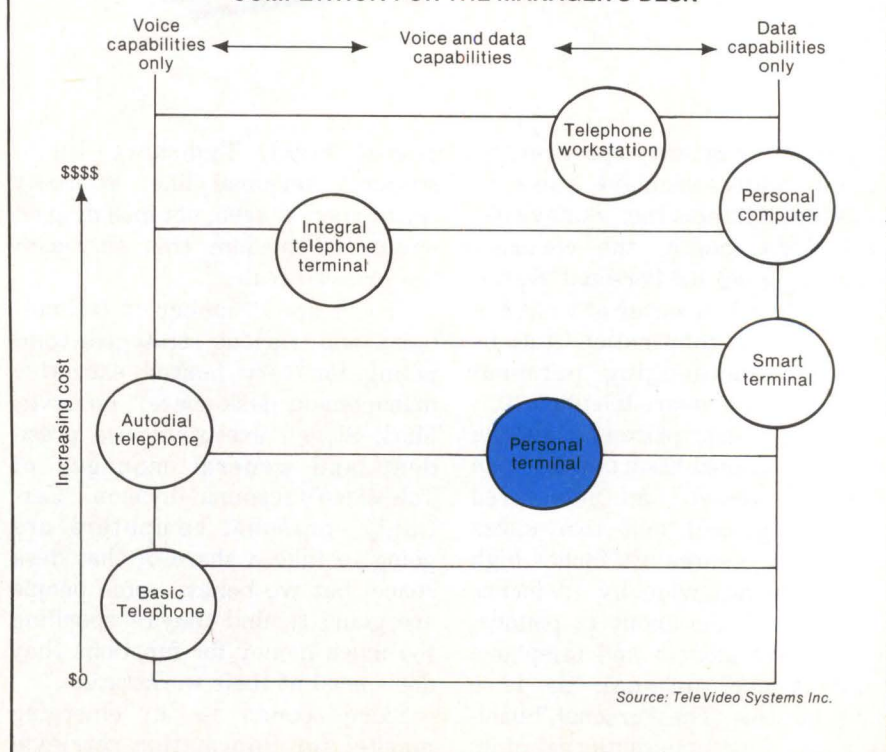

Source: TeleVideo Systems Inc.

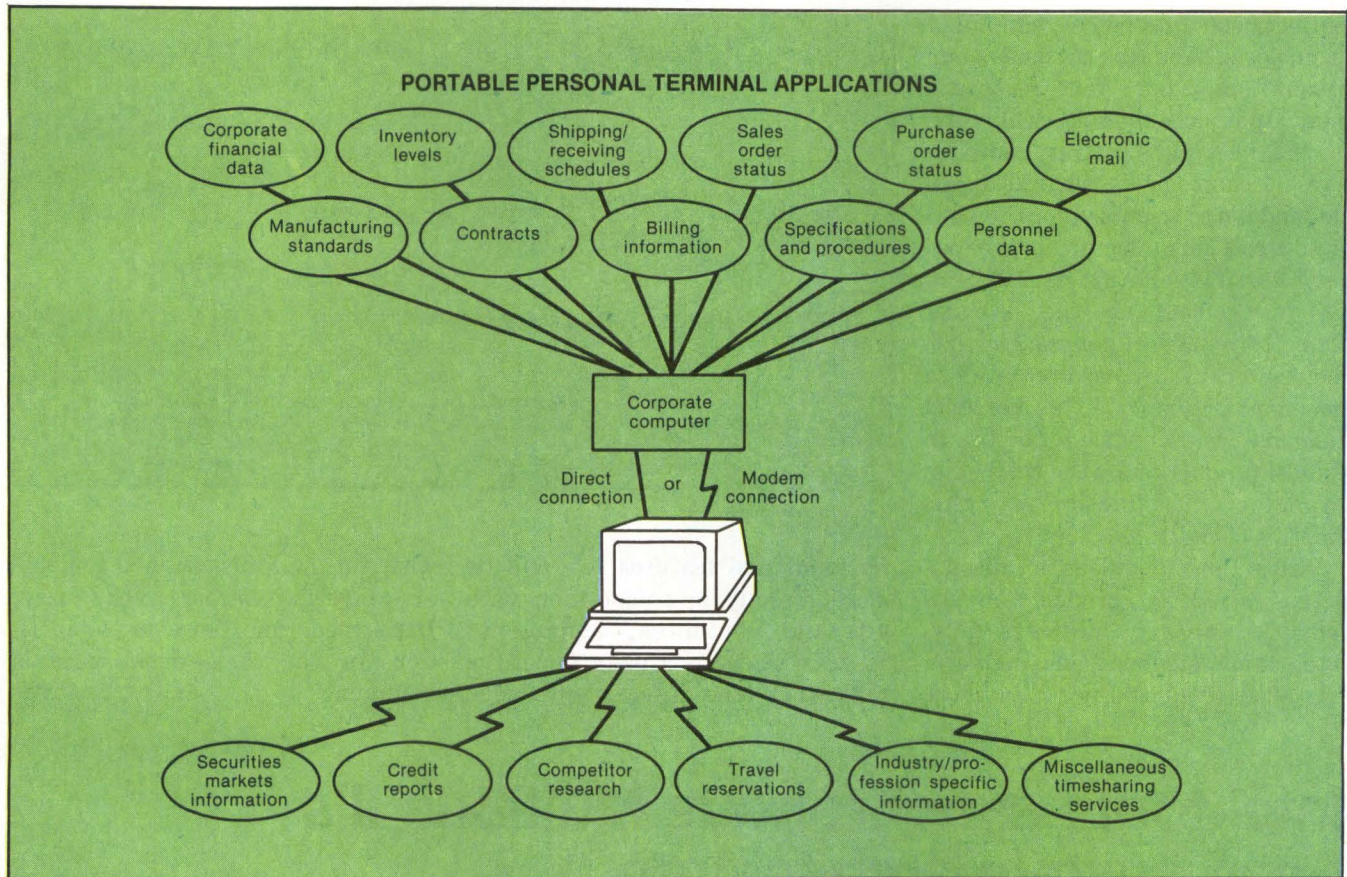

TeleVideo's Personal Terminal is for corporate executives and managers who don't spend much time working with a computer and thus don't need a full-blown microcomputer on their desks. These professionals need access only that information developed within their companies.

Although telecommunication capabilities play a crucial role in the information-station concept, TeleVideo's first entry in this market will not have an integral telephone system. A 300-baud modem priced at \$130 or a 1200-baud modem at about \$600 are optional, as is a snap-on phone handset for about \$75. The modem attaches to the terminal's logic board. Lynar sees one major use of the programmable function keys as automatic dialing of frequently-used numbers.

To reach the terminal's primary market of corporate managers more effectively, TeleVideo plans to beef up its direct sales to Fortune 1000 companies. The company also sees a secondary retail market developing for home users looking for an

economical way to access popular database services. "Our existing distributor network already reaches that market through storefronts," Siegel notes. "But we also will look at the possibility of approaching it through major department store chains."

Siegel believes that the small footprint and versatile applications of the Personal Terminal will make it particularly successful with OEMs and system integrators because firmware can be customized. There is room for an optional 4-by-7-inch board for OEM add-ons such as communications protocol converters. Siegel thinks the Personal Terminal will be used heavily as a display station in local-area networks and distributed-processing

environments. There, the terminal will make it economically feasible to add many users.

TeleVideo sees its competition coming from three disparate directions: personal computers, integral "intelligent" phone terminals and traditional low-end terminals. Lynar suspects traditional low-end dumb terminals will have difficulty competing in the information-station market because they are larger and lack user prompts for specific information-retrieval applications.

Although several other manufacturers have introduced low-end terminals with integrated modems, Lynar hints TeleVideo has more price flexibility because of the manufacturing volumes it expects

Mini-Micro World

NEWS

and because of its newer, simplified technology. "You look at some of our competitors, and you recognize their approach is not really the same," he claims. "[Our competitors'] technology is several years old, and it's too complex for the kind of low-cost manufacturing we believe possible," he insists. "This is also a problem for the integral phone terminals in general, in that they're technically hard to optimize for manufacturing." The Personal Terminal is scheduled to be in volume production by the time of its expected introduction at this month's Comdex.

While TeleVideo does not discuss details of future products in the family, these may include a fully-integrated telephone and memory. "As it evolves and we add more

TELEVIDEO'S PERSONAL TERMINAL'S PAYBACK

If:

- ✓ The average manager gets 10 reports or memos per week, each averaging 2.5 pages.
- ✓ The average secretary earns \$22,000 per year in salary and benefits.
- ✓ 30 minutes per week of secretarial time is spent waiting in line at the copier, copying these reports and filing them.
- ✓ 10 minutes per week of mail clerk time is spent sorting and delivering these reports.
- ✓ The average copying cost per page is 3 cents for paper and processing.

Then:

The Personal Terminal will save each manager approximately \$7.50 per week or \$390 per year (resulting in a 1.2-year payback period) while affording the manager the convenience of having any report he needs at his fingertips.

functions and features, we will be more directly in competition with PCs and portables," comments Siegel. "There is a point down the road where the difference between

what this and the personal computer evolve into becomes very fuzzy. In the meantime, however, competition for the same desk space is beginning." —Edward S. Foster

Intel touts synchronous Multibus II's open system architecture

As the Futurebus standard proposal drew comments from industry

participants at a West Coast Institute of Electrical and Electron-

ics Engineers (IEEE) committee meeting recently, Intel Corp. readied its own synchronous bus to propose to the IEEE P896 committee. Intel sources plug the Multibus II as an advanced open system architecture with an improved 10-MHz speed.

By advanced, John Beaston, technical marketer for Multibus II,

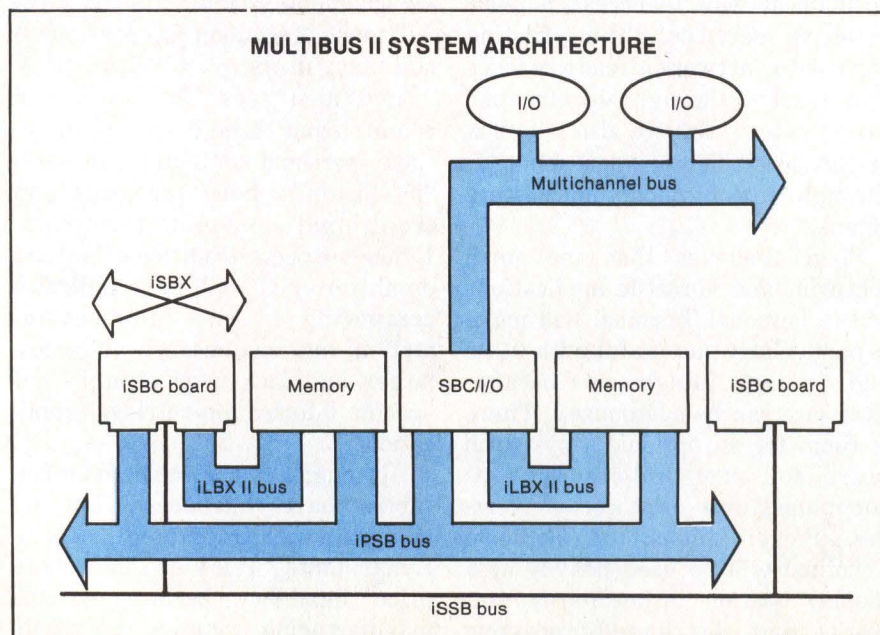

The five internal buses in Multibus II linking iSBC system boards and memory are the parallel system bus (iPSB), which has a theoretical 40M-byte-per-second data rate (with zero access time-memory) and a 96-pin DIN connector, the iLBX II local bus extension with a 48M-byte-per-second data rate if wired through a second connector, the iSSB Serial system bus with 2M bit-per-second data rates that connects via two wires in the 96-pin DIN on the parallel bus, the iSBX local I/O expansion bus that runs at 10M bytes per second and has a separate on-board connector and the multichannel bus that operates at 8M bytes per second through a top edge connector.

means a synchronous, multiplexed 32-bit bus that will use burst transfers, have data integrity checks and conform to the Eurocard form factor.

In previous synchronous systems, once a read or write cycle has begun, the data must arrive in a stated number of clock cycles. This puts a rigid constraint on the system. Multibus II allows the number of clock cycles to vary according to processing needs. This method prevents a problem that asynchronous systems have when cross talk and static cause extra signals on the control lines. Asynchronous systems read such extra signals directly.

Multibus II multiplexes the ad-

resses and data so that fewer lines are required. The entire bus fits on one 96-bit Deutsches Institut für Normung (DIN) connector. Burst transfers avoid speed loss that occurs when addresses are constantly sandwiched between data cycles.

The Eurocard form factor is becoming increasingly popular because its modular design allows designers to put boards with different numbers of connectors into the same card cage. Instead of an edge connector, which is limited to two rows of contacts, the Eurocard DIN 41612 two-part connector has three rows of pins said to provide more reliable connections. The VMEbus, a competitor of Multibus

II, also uses the Eurocard form factor. The VMEbus is backed by Motorola Inc., Signetics Corp. and Mostek Corp. It uses a two-connector, 160-mm.- (6.3-inch-) deep card and requires use of all 96 pins of one connector and the middle row of pins on the second connector.

Beaston says Intel decided a 160-mm.-deep card was too small to get much functionality on it. Multibus II uses a one- or two-connector-wide-by-220-mm.- (8.8-inch) deep Eurocard. "You can use either one," explains Beaston, "because we can put our whole system bus on one connector. So you can use the one-connector-by-220-mm. board to save costs and still have the whole bus interface there."

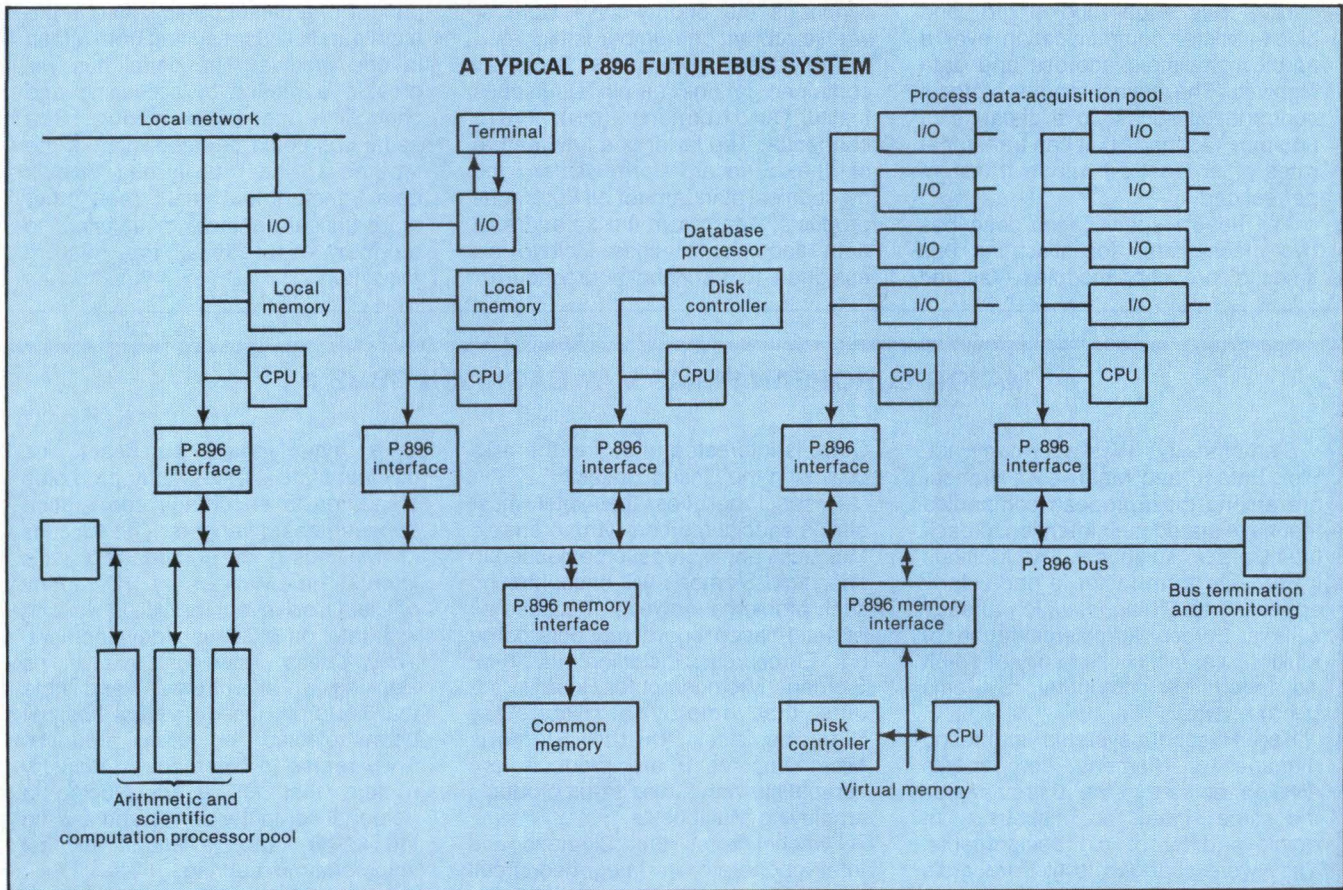

Intel's Multibus II synchronous bus may be a sister bus to the synchronous version of Futurebus being reviewed by the IEEE P896.2 working group. In the case of the P896.1 specification for the asynchronous version, there are two assignments made to allocate bus time for competing devices: fair and priority, depending on a device's assignment. The 896.1 bus has 96 lines, all contained in one 96-pin connector. There are 32 address/data lines, six lines for handshake procedures, 13 for arbitration and 23 for logic controls over power and voltage levels.

Mini-Micro World

NEWS

He says the two-connector board is typically used because of its more reasonable size. The two-connector-by-220-mm. card has about the same area as a Multibus I card, and,

Beaston claims, "You can get about the same functionality on it."

Another advanced feature of Multibus II is its multiple bus structures. Besides the parallel

system bus, there are three new buses: a local bus extension called LBX II, a serial version of the system bus and an I/O extension bus. LBX II is primarily a private passage

IEEE WILL REVIEW FUTUREBUS BASED ON EUROCARD FORM

The Futurebus standard, now under review by an Institute of Electrical and Electronics Engineers (IEEE) committee, comprises a family of advanced backplane buses for multiprocessor systems. The most advanced bus in standardization within IEEE is the working group's P896.1. It differs fundamentally from both Multibus II and the upcoming P896.2 because it uses an asynchronous, rather than synchronous, data-transfer protocol.

The P896.1 specification is for a parallel bus supporting single- and block-transfer communication over a 32-bit multiplexed address and data highway. The asynchronous protocol supports broadcast to a distance of 500 mm. (20 inches). It can transfer at rates of at least 10 million transfers per second.

The P896.1 specification describes two mechanisms for allocating bus times to competing modules—fair and

priority. Devices whose claim on the bus is approximately equal are assigned a "fairness" class. A member that has had control of the bus desists from making further bus requests until no unfulfilled requests remain. Devices that can wait only a limited amount of time to get onto the bus qualify for the priority-class, whose members have higher arbitration numbers than those in the fairness class. When members of both classes are competing, the winner is the priority-class member whose arbitration number is highest.

The bus employs 96 lines, all contained in one 96-pin Deutsches Institut für Normung (DIN) 41612 connector. The latter is a key feature of the Eurocard form factor, the mechanical standard for all Futurebus products. Apart from the 32 address/data lines, other lines include six assigned to handshake procedures,

13 to arbitration and 23 to the logic that controls power and voltage levels. Futurebus uses a triple-height Eurocard, leaving two other complete 96-pin DIN connectors free for other buses and input/output channels. Other Futurebus variants are expected to provide the same flexibility by using just one DIN connector.

Another feature of P896.1 that probably will be provided with other Futurebus types is an optional serial bus. Its role will be to reduce the danger of a catastrophic failure in the main parallel bus resulting from a fault in one module. The serial bus will provide a means of accessing and controlling the failed module. The serial bus could be used most of the time as a system utility and for bulk data transfers that might delay other more critical transfers or transfers to devices external to the system chassis.

—Keith Jones

MAJOR EUROPEAN FIRMS MAY BACK MULTIBUS II

Siemens A.G., West Germany, ICL Plc., Britain, and Matra S.A., France, are among the European companies that have stated their intention to back Intel Corp.'s Multibus II. The Multibus II Eurocard form factor is particularly appealing to Siemens, which already sells a Eurocard implementation of Multibus I as part of its family of 16-bit Advanced Microcomputer Systems (AMS) boards.

Karl Hirschel, systems marketing manager of Siemens' components division, notes that the AMS bus uses the same signals as Multibus I but employs different pin assignments. They were changed to fit Eurocard's Deutsches Institut für Normung (DIN) 41612 two-part edge connector. Hirschel notes that Western Digital

Corp. is interested in selling the AMS boards in the United States.

Hirschel believes that Intel must offer a special motherboard to enable Multibus I and II cards to be housed in one rack. Siemens will encounter no such problems, however, because all its Intel-based board products come on Eurocards, including its 8-bit Siemens Microcomputer Board products that employ a proprietary Siemens bus. All the Siemens Microcomputer Board products are compatible with future 32-bit products employing Multibus II.

Hirschel notes that Siemens and Intel cooperate in integrated-circuit development but compete in the board market. Unlike Siemens, ICL does not sell board-level products but

is a major board purchaser. ICL officials state the company promotes standards to encourage cooperation between board vendors. The success of Multibus I is encouraging ICL's interest in Multibus II. Company officials also reveal that ICL is working with Intel on Multibus II development. They stress, however, that ICL is "looking at alternatives" and note that Motorola Inc.'s VMEbus has not been rejected for future products. They refuse to comment on industry rumors that ICL is developing a personal computer configured around the 32-bit Motorola 68020 for first shipments next spring.

—Keith Jones

The CONCEPT AVT

Because VT100 users deserve more than just VT100 compatibility.

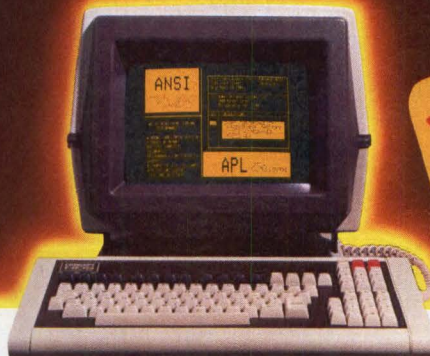

NEW! AND THERE'S EVEN MORE IN THE NEW CONCEPT AVT +

- New ergonomic features including ultra-low profile keyboard with adjustable height
- VT100-style numeric pad for DEC software compatibility
- Increased functionality, including four LEDs, volume control, more function keys
- Same low price

THE CONCEPT DISPLAY TERMINAL

VT100 compatibility is one thing, but eight pages of memory, programmable function keys, windowing, multiple computer capabilities, ANSI standard conformance...and VT100 compatibility is something else. Only from Human Designed Systems.

A good news/great news story from Human Designed Systems.

First the good news. The *concept* AVT display terminal gives you everything you need in an 80/132-column ANSI/VT100-compatible display terminal. And at a very competitive price.

Now the great news. The *concept* AVT display terminal provides an exciting, new set of capabilities that lets you do much more. Without changing the price.

It starts with ANSI standard conformance, DEC software compatibility, and 80/132-column capability, and extends that even further by offering eight pages of display memory to relieve the interactive user of the need to generate unnecessary hardcopy printouts and to provide the application developer with a powerful tool for applications requiring multiple formats and storage of large volumes of text; by enabling users to permanently configure a terminal for their needs or applications; by providing functionality

\$1295*

designed to improve the effectiveness of slow-speed applications; by enabling users to create true windows within display memory; by providing programmable function keys which transmit data and/or execute terminal commands; by providing up to three additional communications ports for connection to other peripherals and computers; by providing flexible user networking functionality for use in a wide range of different applications, including multiple computer connections; and by doing much more.

VT100 compatibility and ANSI standard conformance. Add it to the *concept* display terminal's 132-column performance, in ASCII or APL/ASCII models, with multiple computer capabilities, windowing, programmable function keys, multiple pages of memory, and much more, and you can see why Human Designed Systems has given terminals a new meaning...and that means true economy.

human designed systems, inc.

3440 Market Street, Philadelphia, PA 19104
215-382-5000

*Quantity one. DEC and VT are trademarks of Digital Equipment Corporation.

Human Designed Systems. We're redefining terminal performance.

Atlanta — (404) 391-9763; Boston — (617) 329-3510; Chicago — (312) 825-2960; Dallas — (214) 437-1888; Delaware — Infocon: (302) 239-2942; Denver — (303) 469-1953; Hawaii — Gray Associates: (808) 261-3751; Los Angeles — (213) 410-9454; Northern New Jersey — Infocon: (201) 624-1372; New York City Area — Infocon: (212) 689-8833; New York State — Naco Electronics: Rochester: (716) 223-4490; Syracuse: (315) 699-2651; San Francisco — (415) 692-4184; Washington, DC — International Systems Marketing: (301) 279-5775; Argentina — Itron SA: (01) 744-9369; Australia — Computer Clarity PTY Ltd.: (02) 241 3885; I. O. Peripheries Pty. Limited: (02) 427 3555; Belgium — BELCOMP: 091/25 22 88; Canada — CAIL Systems: Toronto: (416) 362-1063; Denmark — ADCOM Data Aps: 1-19 44 66; Finland — Modulsystem OY: 0-6926511; France — Wallon: (1) 226.06.90; Singapore — DTS Singapore: (65) 33-88-566; Switzerland — Mitek ag: 02/461 22 52; United Kingdom — Shandell Systems Ltd.: 02407-2027; West Germany — COMKO Computersystemges, mbH: 0221-48 30 51. INTERNATIONAL DISTRIBUTORSHIP INQUIRIES INVITED.

CIRCLE NO. 17 ON INQUIRY CARD

THE WY-50. PRETTY SMALL

A NEW GENERATION OF LOW-COST TERMINALS FROM WYSE.



Never before has anyone put so much into something so small. The WY-50 gives you big terminal features without occupying your entire work-space. This took revolutionary design. Design a lot of people couldn't accomplish for the price. But we did.

In fact, the WY-50 introduces a new standard for low-cost terminals. You get a compact, full-featured design that meets the most advanced European ergonomic standards. 30% more viewing area than standard screens. And a price tag as small as they come.

The WY-50 sells for only \$695.00.

FEATURES:

- 14" screen.
- 80/132 column format.
- Soft-set up mode.
- High resolution characters.
- Low-profile keyboard.
- Industry compatible.
- Only \$695.00.

For more information on the revolutionary design, outstanding features and unique good looks of the new WY-50,

contact WYSE and we'll send you a brochure filled with everything you need to know. The WY-50. The full-featured terminal with the small price.

WYSE *Make the Wyse Decision.*

WYSE TECHNOLOGY, 3040 N. First St., San Jose, CA 95134, 408/946-3075, TLX 910-338-2251, in the east, call 516/293-5563, call toll-free, 800/538-8157, ext. 932, in CA 800/672-3470, ext. 932, in the midwest, 313/227-5011, in So. CA, 213/340-2013.

Mini-Micro World

NEWS

between a CPU board and a separate memory board. Two additional buses borrowed from Multibus I are Multichannel, a direct-memory-access (DMA) I/O bus, and SBX, which allows users to attach small daughterboards on top of the main board, adding one serial or parallel port per SBX.

Beaston says the most significant advanced feature of Multibus II is its integration of a message-passing protocol into the system bus. Thus, it has a standardized protocol that defines how disk-controller modules, communications modules and CPU modules with different degrees of intelligence communicate with each other. Because the protocol does not change, it resides on a very-large-scale-integration (VLSI) chip to save space. Intel claims the advantage of communications protocol is that it allows the system to be upgraded by, for example, changing from a single-density to a dual-density floppy disk drive. "You can have a single-density disk board that has a message interface and, two years later, you can unplug that and plug in a double-density disk board with a message interface. You don't have to rewrite your software at all," claims Beaston.

Another facility of Multibus II, called Interconnect, aids in testing, configuration and debugging. Interconnect is a special address space that uses software to identify the boards in the system and choose the hardware configuration of the boards.

Open system architecture is an important part of Intel's design strategy with Multibus II. The goal of open systems is to decrease the lead time between the introduction of a new VLSI component and its integration into systems. The standard protocol for message passing is the key feature of open systems. It allows new kinds of CPUs to be plugged into a Multibus

SYSTEM BUS COMPARISON

	Multibus II	VME	P.896.1
Data width	32	32	32
Address width	32	32	32
Protocol	Synchronous, burst multiplexed	Asynchronous, burst non-multiplexed	Asynchronous, burst multiplexed
No. of masters	20	Less than 20	32

EUROCARDS AS USED IN THE FUTUREBUS

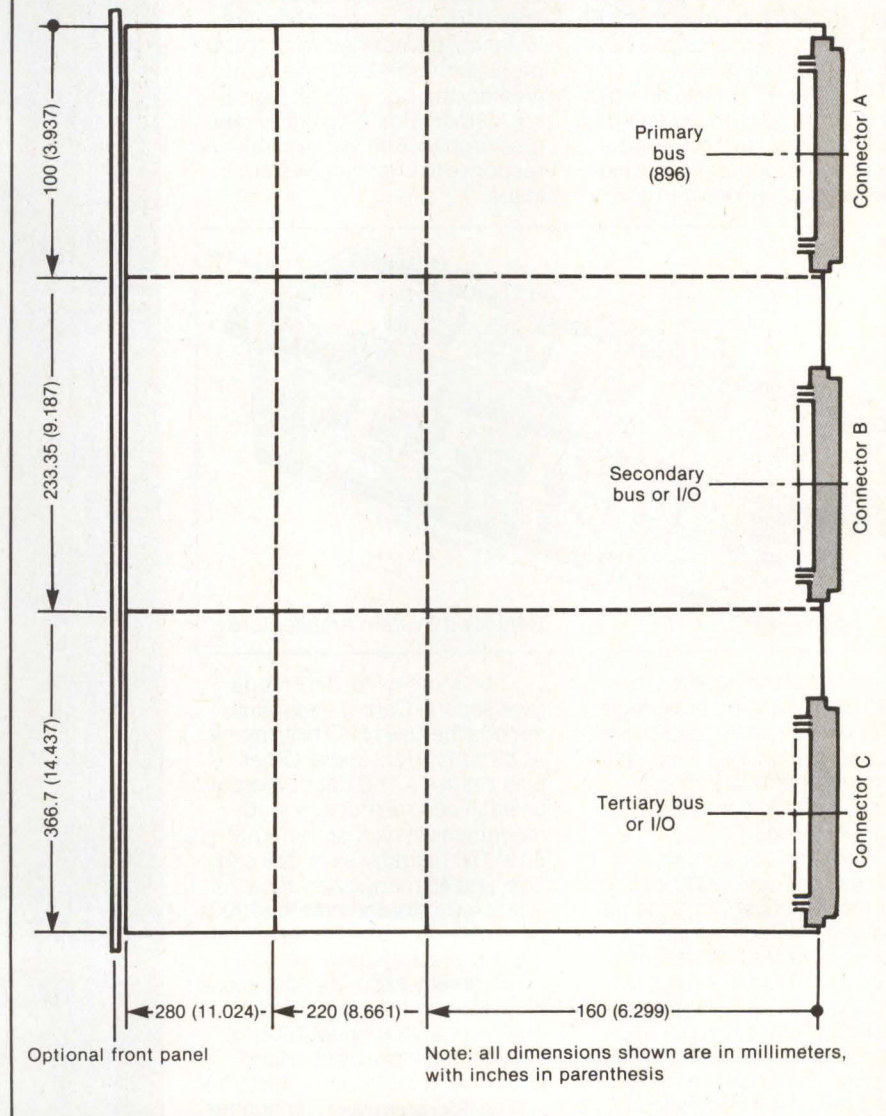

Major new buses, such as the P896 Futurebus and Intel's Multibus II, incorporate the Eurocard form factor. The dimensions of the triple-height Eurocard used in the Futurebus family of 32-bit buses are shown. The P896 working group of the Institute of Electrical and Electronics Engineers (IEEE) is defining the specifications of the Futurebus.

AS OF NOW, ON-LINE TR WILL BE PLAYED BY

ARETÉ

Rule #1: On-line transaction processing systems will be priced within reach of small to medium sized businesses.

The high cost of on-line transaction processing computer systems has put them out of reach of most small to medium sized businesses. That is, until now.

The Arete' 1000 is an affordable high performance computer built specifically for real world transaction processing applications like reservations and ticket-

Rule #2: An Arete' Systems computer will deliver performance equal to that of a mid-sized minicomputer.

Our engineers created some innovative architectural solutions to harness a proper balance of speed, reliability, and price. For instance, as many as four central processors share a common main memory through a 32-bit Processor Memory Bus. This tightly coupled architecture allows quick response to changing system loads.

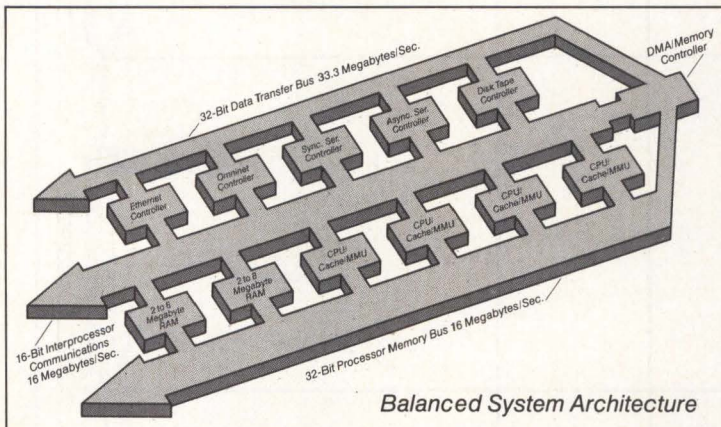

ing, on-line banking and electronic funds transfer, brokerage and insurance, order entry, inventory, billing, manufacturing control, point-of-sale, information utilities, electronic mail, and communications.

Unlike traditional computer systems, the Arete' 1000 was built to a strict list of performance parameters dictated by systems users. It includes features they told us they need, like a high Input/Output bandwidth, large storage capacity, and low per user cost. And virtually none of the features that contributed most to the high cost of on-line transaction processing systems in the past.

The 32-bit-wide, 33.3 megabyte/second Data Transfer Bus speeds the flow of I/O to as many as 60 concurrent users. Other features like a 4KB cache memory on each central processor, 16 megabytes of high speed RAM, 80 to 156 megabytes of disk storage, and 45 megabytes of cartridge tape storage give the 1000 performance comparable to many minicomputers.

To greatly expand applications and systems software choices, we designed the Arete' 1000 to support two industry standard operating systems, Unix System V and RM/COS. Available languages include COBOL, C, FORTRAN, Pascal, BASIC, and AP/L. This means it's possible to easily and economically move standard software to and from the Arete' 1000.

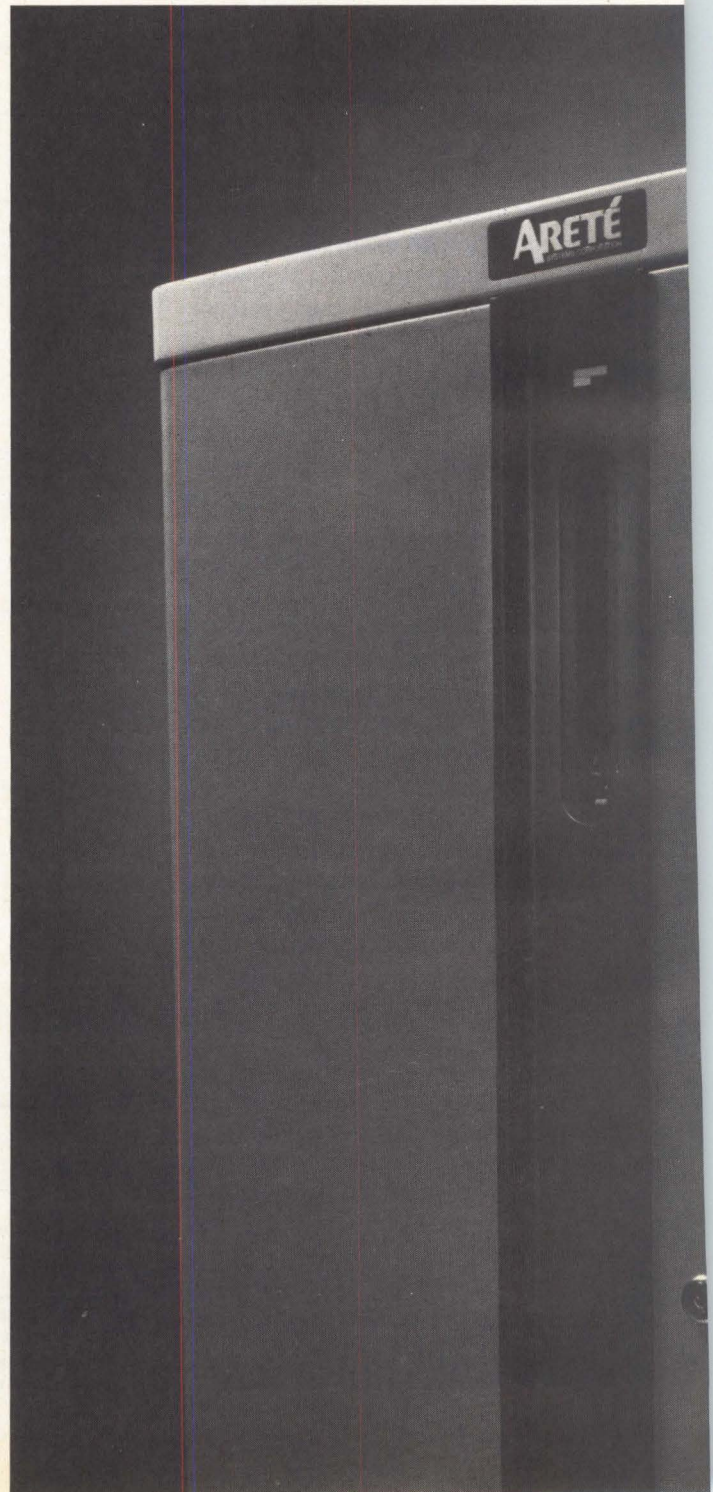

TRANSACTION PROCESSING A NEW SET OF RULES.

RULES.

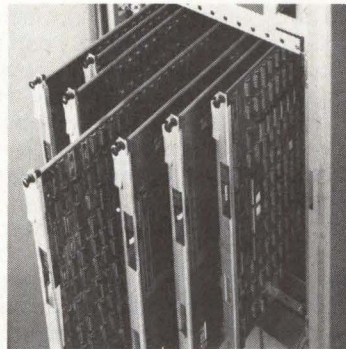

The Arete' 1000's spacious cabinet accepts any combination of CPU or memory boards, DMC, or IOCP boards up to a total of nineteen.

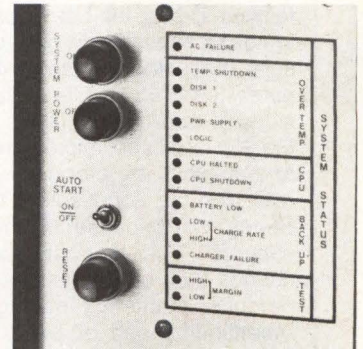

Diagnostic status panel assists in diagnosing system problems.

Rule #3: A low priced computer shouldn't be expensive to own.

The cost of service is a major part of the cost of owning a computer. We've taken steps to keep it to a minimum.

Each of the 1000's component parts has been designed to facilitate testing. And each subsystem has been designed to support automated test procedures. In addition, each of the processors has the ability to test itself. The location and nature of problems is flashed on the system's status panel. A field diagnostic system, which may be run remotely, pinpoints problems in any of four major subsystems. As a result, field service time is kept to a minimum.

We have even included an automatic system to warn of potentially damaging heat buildup. And to keep you on-line during a power failure, we've provided a battery backup system.

Rule #4: There is only one level of quality...excellence.

To the ancient Greeks the word *Arete'* meant excellence in all things. We felt it would make an appropriate name for a company committed to becoming a leader

in providing on-line transaction processing computers to the OEM and systems integrators. And there is only one way to be a leader... by applying excellence in all things.

If you would like more information about the Arete' 1000, please call or write Arete' Systems Corporation, 2040 Hartog Drive, San Jose, California 95131. (408) 263-9711.

Excellence in all things

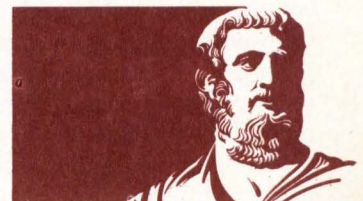

ARETE'
SYSTEMS CORPORATION

See us at
COMDEX/Fall '83

Copyright 1983 Arete' Systems Corporation. UNIX is a trademark and service mark of Bell Laboratories. RMI/COS is a trademark of Ryan McFarland Corporation.

CIRCLE NO. 19 ON INQUIRY CARD

Mini-Micro World

NEWS

EUROCARD 8-BIT BUSES PROLIFERATE, NEED FOR STANDARDS IS QUESTIONED

Besides the group led by Motorola Inc. with its VMEbus, at least two other major U.S. board-level computer suppliers sell bus products employing the Eurocard form factor. Digital Equipment Corp. offers Euro-Q-bus, a Eurocard implementation of the familiar Q-bus for LSI-11-based systems. National Semiconductor Corp. sells the CMOS industrial microcomputer (CIM) line of boards on both sides of the Atlantic. CIM is based on the 8-bit NSC800 microcomputer line and employs the proprietary CIMBUS.

Euro-Q-bus is not sold in the United States yet because of the lack of support. But that situation could change very quickly, states Eurocard products marketing manager Edgar Valentine, based at DEC's Reading, England, office. Valentine notes that Euro-Q-bus employs the same signals as a regular Q-bus but different pin assignments. This change accommodates the Deutsches Institut für Normung (DIN) 41612 two-part con-

necter, a key feature of Eurocard packaging. Valentine estimates that the DIN connector is 10 times more reliable than an edge connector. He points to DEC's need to comply with the form factor requirements of LSI-11 customers in Europe, particularly in applications in which a computer can be a secondary part of a system, such as in process control, communications and defense. He notes that one LSI-11 processor board may have to share an enclosure with as many as 10 Eurocard boards from other suppliers.

The compactness of the single-height Eurocard—100 by 160 mm. (4 by 6.3 inches)—was another major attraction for National Semiconductor when it developed its CIM boards, states Reinhold Hohol, European board-level products manager in Munich, West Germany.

Hohol explains that the CIM products are aimed at hostile-environment applications. U.S. users

include the state of Texas, with an application in oil- and gas-pipeline monitoring.

Although CIM boards are form-factor compatible with the STE bus being specified by the Institute of Electrical and Electronics Engineers (IEEE) working group P1000, Hohol insists that there is no need for CIMBUS to be electrically compatible with STE or any other bus. He notes there are about 50 Eurocard-based 8-bit buses sold in Europe. "The bus is irrelevant as long as it provides the same functionality of other buses," Hohol asserts, adding that bus standards are needed only for buses with 16 bits or more, in which development cost is an order of magnitude higher. But P1000's European secretary, Tim Elsmore, counters that STE is needed because of the many different 8-bit buses and the need for a bus that offers processor independence.

—Keith Jones

II-based system. "It isn't at the point yet where an end user with no experience can literally pull out and plug in boards. But it's moving in that direction and [is] closer to Multibus II," notes Frank Costa, Intel's strategic marketer for Multibus II.

An open system must also be processor independent. With asynchronous buses such as VMEbus, different boards and processors can communicate with each other at different data rates without timing problems. With synchronous systems, timing of different modules is more difficult. Multibus II solves the problem of processors and boards having different operating speeds by synchronizing the output of different boards to the speed of the bus at the bus interface. However, Paul Borrill, a research fellow at University College, London, and chairman of IEEE's P896 standards committee, notes that, although

synchronizing the boards' output achieves processor independence, the 10-MHz bus speed is the limiting factor of the system. As a result, if Intel wants to increase the data rate of the bus, a new bus standard would be necessary. Beaton notes that, because the bus is now at the forefront of technology, Intel expects it to be a standard for 10 years.

Another feature necessary to make Multibus II an open system is a bridge to Intel's Multibus I system. The company says that, because the theory behind the Multibus I and II is the same, they can communicate with each other using a physical link between the different connectors.

Intel is expected to publish the final Multibus II specifications this month and to present those specifications to the IEEE P896.2 Futurebus committee for consideration as the standard synchronous compo-

nent of Futurebus.

Borrill believes no conflict exists between the goals of the P896.2 (synchronous) standard and Multibus II, and he expects that Multibus II will be a sister bus to P896.2. Borrill and industry analysts see Intel's willingness—even eagerness—to publish information on Multibus II as an important asset to its promotion as a standard.

—Tom Moran

NEXT MONTH IN MMS

The December issue of Mini-Micro Systems, the annual technology review, is MMS's encyclopedic resource for its unique readership of value-added OEMs and users, and resellers. It consists of feature articles about various technologies, with market and product data in graphs, charts and tables.



In November, We're Gonna Blow Your Socks Off.

In November, Intertec will take the wraps off the smallest, smartest, fastest, most powerful business computer anyone can buy.

Come December, we suspect most everyone in this industry will be walking around barefoot.

So no matter what your requirements for business computers are, or if you're simply in need of a free pair of socks, write on your letterhead to: Intertec, Dept. "M," 2300 Broad River Road, Columbia, SC 29210. Limited sock quantities available.

intertec[™]

*See us at Comdex
Booth #6104
Las Vegas, Nevada
Nov. 28-Dec. 2*

CIRCLE NO. 20 ON INQUIRY CARD

MORE HIGH PERFORMANCE FROM CIPRICO™ RIMFIRE™ 50 SMD DISK CONTROLLER

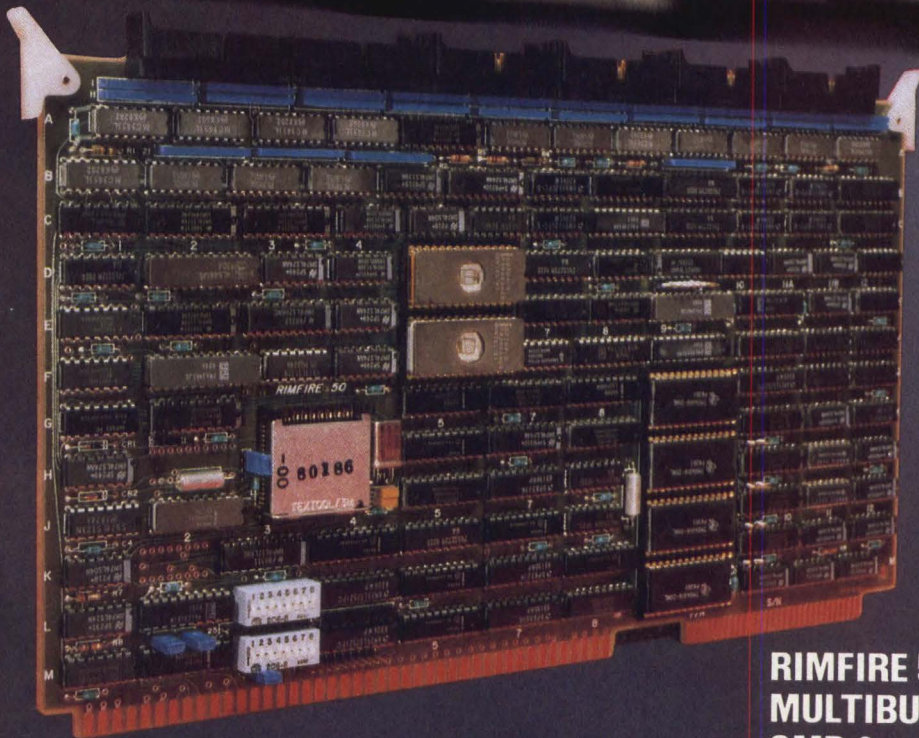

RIMFIRE 50, Intelligent
MULTIBUS* CONTROLLER for
SMD-Compatible disk drives.

- Programmable sector sizes
- 24 bit DMA
- High-speed disc interface
- 1:1 Interleave
- 48 bit ECC

... and much, much more!

* Multibus is a registered trademark of the Intel Corporation.

CPC

CIPRICO, INC.

Formerly Computer Products Corp.

2405 Annapolis Lane
Plymouth, MN 55441
Phone: [612] 559-2034

CIRCLE NO. 21 ON INQUIRY CARD

Non-volatile memories rejuvenate as bubble prices burst

In the midst of a semiconductor industry recession in 1981, some of the giants of the industry—Texas Instruments Inc., National Semiconductor Corp. and Rockwell International Corp.—concluded that bubble memories were best left to Lawrence Welk. Intel Magnetics, a subsidiary of Intel Corp., was one of the few with enough faith in non-volatile memory technology to risk its multimillion-dollar development.

Intel's faith paid off. Now, its competitors are scarce, and Intel can stake a major claim to what Dataquest Inc., a San Jose, Calif., market research company, forecasts to be a \$100 million market this year. To further the technology, it has signed up its biggest processor-chip rival, Motorola Inc., as a second source and promised its customers dramatic price cuts in the next two years.

The price of the completely configured 1M-bit Intel bubble kit—including controller—will drop from its current \$199 in quantities of 5,000 to \$99 in quantities of 25,000 in the fourth quarter of 1984. This compares to an average quantity—5,000 price of \$150 for a 250K-byte, 3½-inch microfloppy drive. The company also expects to have its 4M-bit (the equivalent of 500K bytes) bubble-memory kit reduced to \$150 in similar quantities by 1986.

"Intel had the determination, the capital and the VLSI technology to pursue a complete bubble system," claims Ulmont Smith, a product manager with Intel Magnetics. "The others just couldn't get it all together, so they went on to other things."

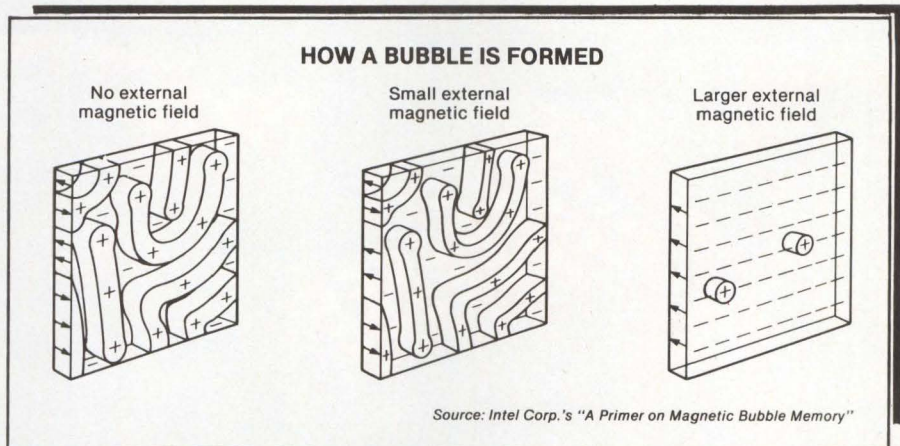

In bubble memory, magnetic domains are constrained to two dimensions on a very thin-film substrate. Their orientations are perpendicular to the substrate. When not subjected to a magnetic field, the domains appear snakelike (left). When a weak magnetic field is applied perpendicular to the substrate, the domains narrow (middle). A strong, applied-magnetic field decreases the domain lengths until they equal the widths, or are cylindrical (right). When viewed under a microscope from above, the domains look like circles, or bubbles. The bubbles move on the substrate from areas of lesser to greater magnetic field strength.

Intel anticipated the coming of the portable computer market. The new briefcase-sized computers not only require less real estate for memory devices but also operate in less-than-ideal environments. Bubbles are featured in briefcase systems like those from Teleram Communications Corp. and Grid System Corp. Others, like Tandy Corp.'s Radio Shack division and Convergent Technologies Inc.'s new briefcase computer user programmable read-only memory (PROM) cartridges. "Some designers were tired of waiting for the bubble market to emerge," says Jim Moore, a senior analyst with Dataquest.

When bubble memories were introduced in 1979, the 1M-bit Intel kit was priced at \$2,500. At that level, applications were limited to high-end users demanding the rugged characteristics of the bubble

over the mechanical weakness of rotating memory devices. In most cases, this meant military applications and sensitive portable scientific instruments.

As a result, many of the heavyweight manufacturers that followed Bell Laboratories into the bubble memory market sensed an ultimate victory for rotating mass-memory devices over bubbles in an increasingly price-conscious market. Few were willing to risk the multimillion-dollar investment necessary to fabricate the bubble's garnet wafer devices. The garnet wafers are 10 times more expensive than the silicon wafers from which semiconductors are drawn.

Bubble memories are high-density, solid-state memory devices in which data is stored as bubbles in a flat, very thin, magnetic wafer. The wafer is magnetically polarized in one direction; the bubbles are

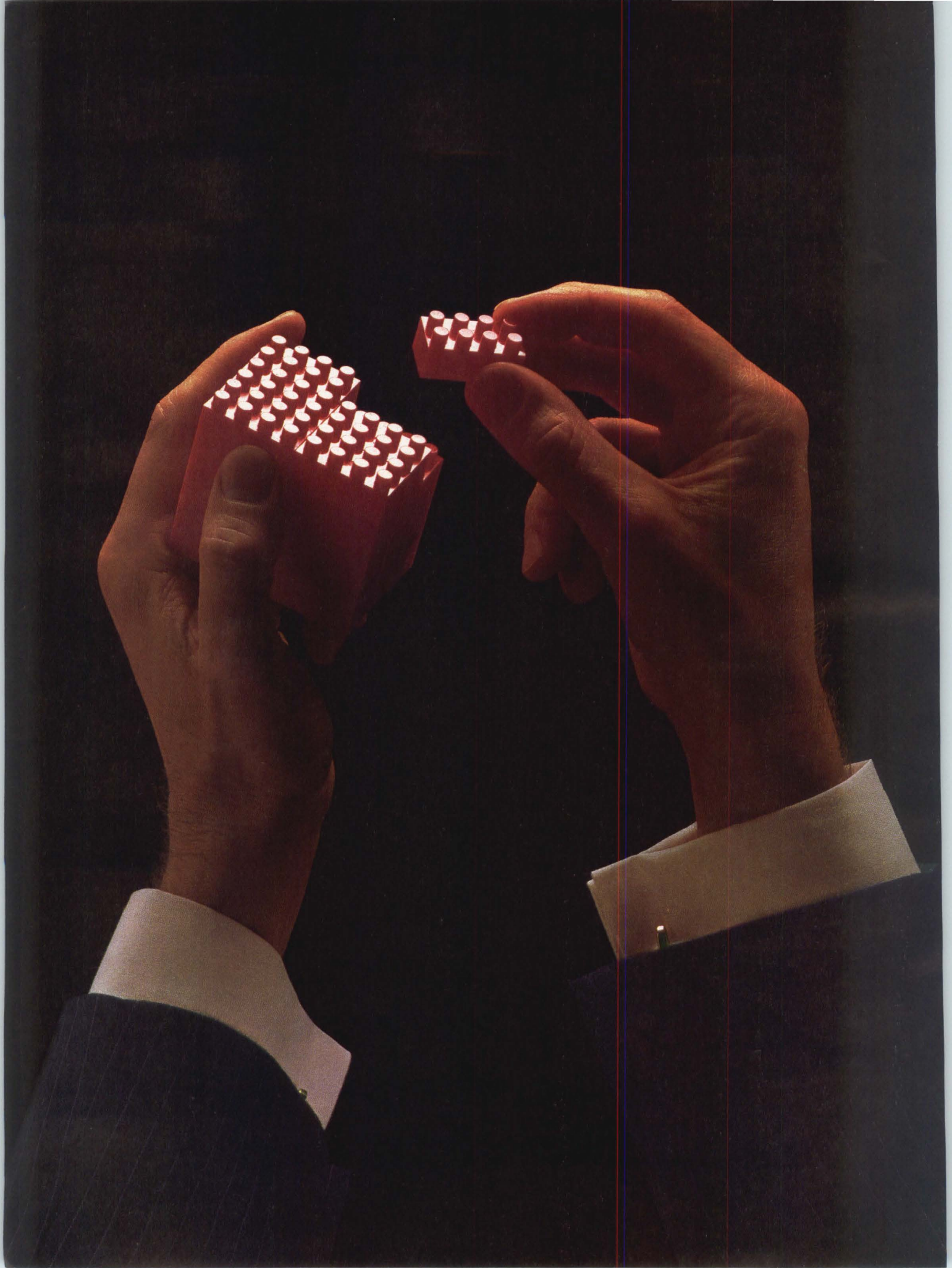

A SYSTEMS APPROACH EVERYONE CAN APPRECIATE.

There is one approach to systems that's designed to hold your interest. Whether you're building systems or building a company that does.

Intel's Open Systems approach.

It means that Intel integrated micro-computer-based systems are built on industry standards like the MULTIBUS® architecture and our iRMX™ realtime operating system. And proposed standards like Ethernet* and Xenix.* So there are no proprietary architectures to get locked into. Or major markets to get locked out of.

What's more, you can change your level of integration at any time. To reduce time to market. Or cut costs. Because our advanced microprocessors, peripherals and board level products are based on those same standards. So you'll never have to worry about the new parts not getting along with the old ones.

Open Systems also means that future products will fit quite nicely into our present distributed processing systems.

So growth-path compatibility and product upgrades should be a snap.

You'll also be positioned to take advantage of breakthroughs in VLSI, while your competition is still toying with the idea.

When you put it all together with Intel Systems, it clicks: lower risks, shorter schedules, state-of-the-art performance, easier customization, future compatibility, and a solid place to put your money.

And that's something everyone can appreciate.

Whether you're the president of the company, or just a kid on the way up.

To learn more about Intel's Open Systems, attend one of our Executive Seminars. Call us at (800) 538-1876. In California, (800) 672-1833.

Or write Intel, Lit. Dept. Z13, 3065 Bowers Avenue, Santa Clara, CA 95051. And we'll give you the dates of the seminars nearest you.

intel® delivers
solutions

See us at Comdex Booth #520

See us at Wescon Booth #3216

See us at Mini-Micro Booth #5632

*Ethernet is a registered trademark of Xerox Corp. Xenix is a registered trademark of Microsoft, Inc. ©1983 Intel Corporation

Mini-Micro World

NEWS

cylinders of reverse magnetic polarity extending through it. Instead of stationary bits being read from a rotating disk, the binary-coded data is read from moving bubbles on stationary media. Under a microscope, the bubbles appear as fluid circles that move in fixed tracks and loops on the garnet substrate. When data is read, a bubble is duplicated—one bubble continues around a loop retaining its memory while the other proceeds along an output track to the read location.

Unlike rotating memories, subject to physical and mechanical limitations, the bubbles can operate in extreme temperature environments. Since they have no mechanical parts, they are less subject to breakdown. Intel advertises a 40-year mean time between failures (MTBF), guaranteeing users trouble-free operation for the life of most systems.

Intel's Smith notes that bubble memory has less power consumption—an important feature in portable units—because it allows the bubble to be turned off completely when the memory is not being accessed. "Most users access a disk about 10 to 15 minutes of each hour a system is in use—yet the disk continues to rotate continuously," he adds.

While pointing out the advantages of bubbles over rotating storage devices, Smith admits that most future systems will continue to use a disk system because of increased storage capacity—current bubbles top out at 4M bits, or 0.50M bytes. Smith believes bubbles can coexist with disk systems, and it is likely they will complement each other. "Bubble memories are likely to be a buffer between RAMs and rotating memory devices," he says.

He envisions a future portable system in which a briefcase comput-

er with bubble memory can be down-loaded into a desktop system with a rotating memory device for permanent storage.

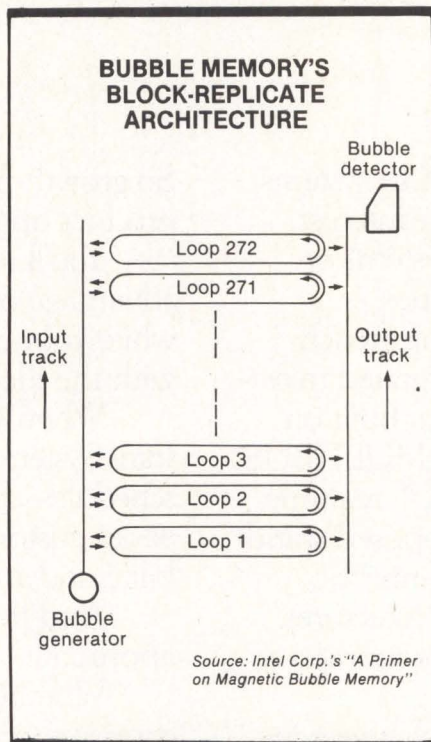

Bubble-memory data storage is in a block-replicate architecture. The architecture has a number of endless storage loops. Bits of successive pages circulate continuously. Two tracks—one input, the other output—are the vehicles for the controller to write and read data in the storage loops. Exchange or replication of data between tracks and loops occurs in all loops simultaneously, which is the key to the block-replicate architecture.

A second growing application for bubble memory is the factory-

automation market, where extreme ruggedness and environmental tolerance is often required.

Bob Nelson, president of Bubl-Tec, Dublin, Calif., a division of PC/M Inc. that makes industrial controllers for the Intel bubble memory, says price decreases have not come fast enough. Bubble memories that can operate at 0 to 70 degrees Celsius are still priced between \$385 and \$445, depending on quantities. Intel's Smith admits the industrial-strength bubbles are still high on the price curve, but he expects they too will ultimately drop in price as volumes and demand become higher.

Meanwhile, Intel sees very little chance of a resurgence of bubble memory competitors. "Most of the companies that were involved in bubble memories were not at the point we were in 1979 when they disbanded their programs—they would have too far to catch up," Smith says. "New start-ups also are not too likely in this market because of the large financial commitment required to fund this technology."

Intel will be content to compete with its foreign bubble memory competitors, including two formidable competitors from Japan—Hitachi Ltd. and Fujitsu Ltd. Most of all, Smith believes, competitive price pressures will come from competing technologies like micro-floppy and half-height minifloppy drives and PROMS.

—Robert A. Sehr

OLIVETTI SETS UP U.S. VENTURE CAPITAL COMPANY

With \$120 million estimated to be invested in U.S. electronics companies, Italy's Olivetti S.p.A is adding to its holdings through a 20 percent share in a U.S. joint venture-capital company. Olivetti officials note that the new firm's total funds will be \$100 million and that Olivetti's partners will be "a group of U.S. and European organizations." They confirm Olivetti's long-term interest in selling a minority share in itself to a U.S. computer company. Olivetti is currently negotiating to reduce the French government's share of the company to less than 10 percent from more than 30 percent.

EMULEX TALKS DEC

7

MACRO STORAGE FOR MICROS...

Good ol' RL02 has a lot going for it: 10.4 megabytes of removable storage, proven reliability, a massive OEM and end-user investment in RL02-based software. But no upward mobility. The only way to expand from micro to macro storage is to add more RL02 cartridge drives.

AT THE CUTTING EDGE...

Enter Emulex and SABRE (Storage And Backup/RL02 Emulation)—at the cutting edge of disk-storage technology. A plug-in-and-play storage subsystem that looks like four RL02 drives to the DEC LSI-11 through 11/23 PLUS operating systems. But what a difference in hardware: A single, compact, high-performance 5¼-inch Winchester with 31.2 megabytes of storage (three RL02 look-alikes); a removable disk cartridge drive, which can do double duty as a systems disk or a source for backup and program loading (one RL02 look-alike); a single-board host adapter that allows you to add up to five additional devices.

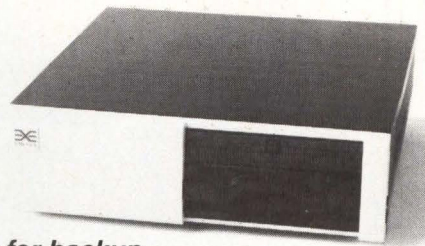

EIGHT-TO-ONE REDUCTION...

The host adapter plugs into any standard QBus slot. The balance of the subsystem, including an integral power supply, is contained in a single rackmount enclosure that occupies one-eighth the space of four DEC RL02s and requires one-fourth the power. Per-megabyte device and media costs are slashed. Average seek time is reduced significantly.

REMOVABLE CARTRIDGE...

SABRE's 8-inch cartridge disk drive features 10 megabytes of fast and easy backup. Media spins in a lightweight, removable, easy-to-handle cartridge. With a transfer rate that is up to eight times faster than that of a conventional 8-inch floppy, and even faster than a streaming tape cartridge. And this ruggedized drive is more resistant to shock and vibration than any other fixed or removable media disk drive. Through the flexible magnetic disk media and the unique design of the drive, users enjoy Winchester-like high-performance and reliability.

EMULEX THINKS SMALL...

SABRE is a first-of-its-kind subsystem, and a first for Emulex: a complete storage subsystem for micro-computers. But not the last. Emulex is thinking small. Soon a wide variety of Emulex-quality host adapters, controllers and peripheral packages will be available for small computer systems. Watch this column to be among the first to know.

See us at Comdex Booth #2030



CIRCLE NO. 22 ON INQUIRY CARD

3545 Harbor Blvd., P.O. Box 6725,
Costa Mesa, California 92626,
Toll-Free (800) 854-7112, In Calif. (714) 662-5600.

Mini-Micro World

NEWS

Liberty offers \$745 terminal with more features, 12-inch screen



Liberty Electronics' \$745 Freedom 200 terminal has more features than earlier family models. Its monitor slopes down to meet the terminal's base, making it easier to access the chassis' four board slots. Another ease-of-use feature is the extra-wide keyboard that groups keys by function.

Liberty Electronics USA, one of the most price-driven companies in the highly price-conscious low-end terminal market, expects this month to make its first thrust into a higher performance category with the Freedom 200 terminal. The 12-inch terminal features an extra-wide keyboard with the keys clustered by function for easier use.

The San Francisco company only two months ago reduced the price of its low-end Freedom 100 model by \$100 to \$495, in part to make room for the Freedom 200, which is to have a list price of \$745. George Chao, president of Liberty, feels that terminal manufacturers in general have "muddied the waters" on basic price/performance issues in

the low-end market, a problem he claims the positioning of his two terminals should help rectify. "You have to make sure the user is not confused, and, with these two products, the difference between the features is clear and is accurately reflected in the difference in price."

The most striking change in the new terminal is the keyboard, which is 4 inches wider than is the Freedom 100's and reduced more than 50 percent in height. Characteristics the Freedom 200 has inherited from the Freedom 100 include a 12-inch, 24-line-by-80 character, green phosphor screen with a 25th status line, a 128-character ASCII set plus extended

graphics characters, a 7-by-9-dot character cell on a 9-by-12-dot character field, 10 programmable function keys and non-embedded video attributes. The monitor can be fully tilted and swiveled, and the low-profile, detached keyboard is said to meet Deutsches Institut Für Normung (DIN) standards.

Other Freedom 200 features include a soft setup mode for the programmable function keys. That mode accesses 256 bytes of non-volatile RAM that can be allocated to any combination of keys. An optional 4K bytes of RAM can be added for another four pages of memory, which can be used either as video memory or as print buffer.

The terminal operates in block-

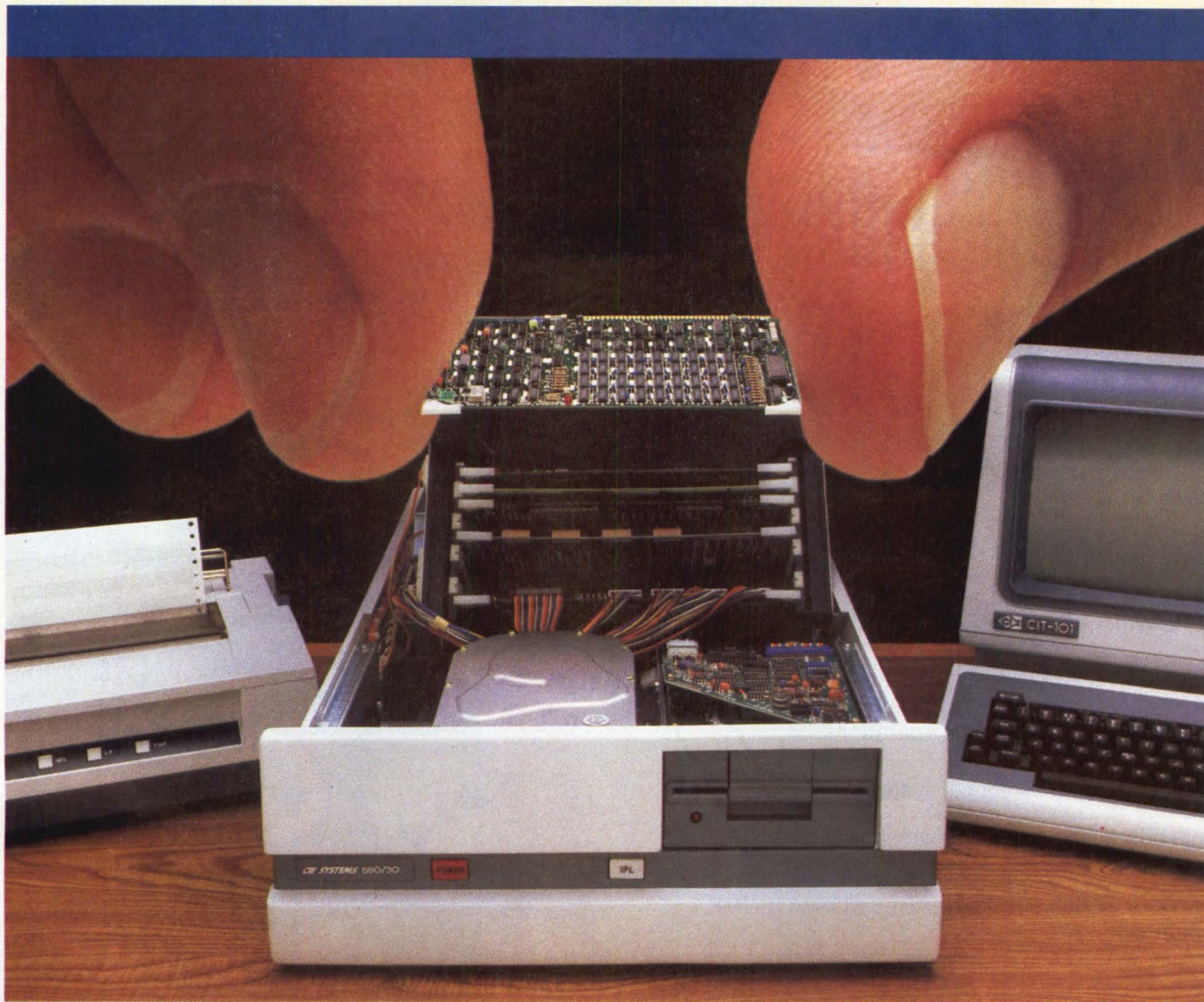

Our giant commitment to OEMs

BOARDS TO SYSTEMS. YOU NAME IT.

CIE Systems is committed to being your source for the very latest in micros and all that goes with them.

The micros are the CIES 680™ Business Computers with the advanced 32/16-bit 68000 microprocessor and Intel's Multibus™ architecture. So from boards to systems, you can easily configure your product line for virtually any business.

There are four 680 models. The 680/30 (shown above), 680/20 (on the right), 680/35 and the 680/40.

See the CIES "Dealer Program of the Year" at COMDEX Booth 1820.



The 680/30 and 680/35 will accommodate up to eight interactive users. The 680/20 expands to four users. And the 680/40 expands to as many as 20 users.

Disk capacities range from 10 to 300 Mbytes, memory from 256K to one Mbyte.

Operating systems include REGULUS™ (UNIX™ compatible) and RM/COS™

Language processors include BASIC, FORTRAN, COBOL and PASCAL.

Applications offered are general accounting, financial worksheet and word processing, as well as a wide range of vertical applications.

And you can include PRO-IV™ the applications processor that allows you to develop applications in one-tenth the time or modify applications in one-hundredth the time it normally takes.

Boards up to complete CIES 680 systems. Our name or your name on them. That's an ongoing commitment to OEMs from CIE Systems, the company backed by the third largest trading company in the world with well over \$50 billion in sales.

Just call or write CIE Systems, Inc., 2515 McCabe Way, Irvine, CA 92713-6579 (714) 660-1800. Call toll free 1-800-437-2341. In California, call 1-800-458-6279.

CIE SYSTEMS
A CITICOR ELECTRONICS COMPANY

TM CIES 680 is a Trademark of CIE Systems, Inc.
Multibus is a Trademark of Intel Corporation.
REGULUS is a Trademark of Alcyon Corporation.
UNIX is a Trademark of Bell Laboratories.
RM/COS is a Trademark of Ryan-McFarland Corporation.
PRO-IV is a Trademark of Data Technical Analysts, Inc.

© CIE SYSTEMS, INC., 1983

CIRCLE NO. 23 ON INQUIRY CARD



Optional 17.8Mb, 35.6Mb or 71.2Mb Winchester disk.

Compact 3M cartridge.

Start/stop tape supports file operations.

Self test with LED display of system faults.

Single board tape controller with bootstrap and direct data transfer.

CONTROLLER ONLY AVAILABLE FOR VOLUME REQUIREMENTS.

Add a little tape backup to your DEC microcomputer

SMS announces a 1/4" tape cartridge peripheral compatible with DEC's TSV05 at half the price. Requiring only 5 1/4" of rack or table top height your Winchester disk can't afford not to have one. The SMS FWT01180 (Q-Bus) or FWT11180 (Unibus*) provides up to 21 Mbytes of storage and emulates the TS11* device supported by standard RT-11*, RSX-11M* and TSX-PLUS** software. Besides disk backup, the low cost tape cartridge can support system boot, media interchange, archiving, journal operations and software distribution applications.

*Trademark of Digital Equipment Corporation **Trademark of S & H Computer

SMS
Scientific Micro Systems, Inc.

777 E. Middlefield Road
 Mountain View, California 94043
 (415) 964-5700

AUTHORIZED SMS DISTRIBUTOR FOR DEC
 Q-BUS PRODUCTS: FIRST COMPUTER CORPORATION (312) 920-1050

SMS SALES OFFICES:
 Phoenix, Arizona (602) 978-6621;
 Yorba Linda, California (714) 993-3768;
 Atlanta, Georgia (404) 296-2029; Morton Grove, Illinois (312) 966-2711; Boston, MA (617) 246-2540;
 Hillsborough, New Jersey (201) 874-7774;
 Seattle, Washington (206) 883-8303.

Mini-Micro World

NEWS

conversation and local-communication modes. User-programmable keys include the print and send keys. The extra-wide keyboard can include seven cursor-control keys and seven dedicated editing keys. Other capabilities of the terminal include smooth scrolling, split screen, double-height/double-width characters, programmable answer back and screen saver.

Compatible with Freedom 100 protocols, the Freedom 200 will also offer standard emulation modes for the TeleVideo 950 and Lear Siegler ADM 31. Liberty believes the two products they have chosen to emulate better represent the Freedom 200's market than the lower-end terminals that the Freedom 100 emulates. "To offer the kind of features we do on this new terminal and emulate a dumb terminal would not allow the user to derive the benefit of the inherent features," says Chao. The Freedom 200 cannot use its non-embedded attributes in emulation mode.

The Freedom 200's monitor slopes down at an angle to meet the base, giving easier access to the chassis containing the unit's four boards. "In the typical pedestal approach, you have to dump the whole unit on its head to get the boards out," says Liberty marketing director Tim Meadows. "With the Freedom 200's design, you remove two screws, and the entire chassis slides out. Servicing the unit is much easier." The chassis also has an empty slot for additional OEM boards. Meadows adds that the angled design should provide better heat control than a flat mounting.

Chao believes the Freedom 200 will set a new price/performance standard. "We are offering high-end terminal performance with features that are not going to be found on [most] other terminals in this price range," he claims. He calls Wyse

HOW THE FREEDOM 200 AND WY-50 COMPARE

	Liberty Electronics USA	Wyse Technology
Product	Freedom 200	WY-50
List price	\$745	\$695
Display size	12 inches	14 inches
No. of columns	80	80/132 selectable
Screen adjustment	tilt and swivel	tilt and swivel
Keyboard	low profile, extra wide	low profile
No. of keys	128	100
Meets DIN requirements?	yes	yes
Function keys	10 programmable	16 programmable

Technology's Wyse 50 (MMS, September, Page 24) the Freedom 200's main price/performance rival. "I think the Wyse 50 is a good terminal. The one advantage it has over us is the 14-inch screen and 132 columns. That is the wave of the future, but, outside of the VT100-compatible market, the software doesn't support it now."

Liberty will market the Freedom 200 through distributor, OEM and end-user sales channels. The terminal will be manufactured on a dedicated line at Liberty's Taiwan facility, with production units scheduled for availability no later than February. OEM quantity discounts are available.

—Edward S. Foster

STUDY MISSION TO JAPAN WILL HIGHLIGHT MICRO-COMPUTER SOFTWARE

A study mission aimed at hardware, software and multinational companies interested in joint ventures with Japanese companies is scheduled for Dec. 4-16 in Tokyo, Japan. The mission's focus will be on microcomputer software for business use and include sessions and company visits. It will address applications, operating systems, languages, software conversion, distribution and support and joint ventures. Richard J. Matlack, president of InfoCorp, a Cupertino, Calif., market research and competitive analysis concern specializing in microcomputer systems, will lead the mission. Joint sponsors are the Technology Transfer Institute and *Mini-Micro Systems* magazine. For more information, contact Mr. Hideaki Hashizume, General Manager, TTI, One Penn Plaza, Suite 1411, 250 W. 34th Street, New York, N.Y. 10119, (212) 947-2648, Telex: 420057; TTIUI.

MEMORY SUBSYSTEM ANNOUNCED FOR IBM PC

National Memory Systems Corp., Livermore, Calif., has introduced its PC-8000 memory subsystem for the IBM PC and PC look-alikes. The subsystem provides as much as 1G byte of storage. The company says the system is intended for use in very large database applications, software development or as a file server in a network. The PC-8000 consists of a controller and one or two disk drives storing 16M to 500M bytes each. The system is said to be compatible with fixed- and removable-media drives. Average access time is 17 msec. The company says the \$25,400 system can run with the Compaq, Victor 9000, Columbia MPC, Eagle PC and other PC-compatible systems.

"DEC AND HP
HAVE A LOT
TO OFFER.
EXCEPT A TRUE
REAL-TIME,
SINGLE BOARD
COMPUTER."

INTRODUCING THE
SINGLE BOARD CLASSIC.

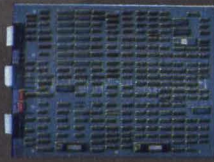

The Single Board CLASSIC from MODCOMP is just what OEMs have been asking for in demanding real-time applications. It's a complete, high-performance, real-time computer with a CPU, 512K bytes of memory, I/O processor, floating point unit, and console interface all on a single board.

Offering the performance of a minicomputer at a microcomputer price, the Single Board CLASSIC is fully compatible with the CLASSIC II line of real-time computers. Using MAX IV, the fastest real-time operating system in the industry, CLASSIC computers respond to external events in microseconds, simultaneously handling thousands of interrupts per second.

The Single Board CLASSIC. It's the real-time computer you can not get from DEC and HP. For more information, call our toll-free number today.

1-800-327-7042

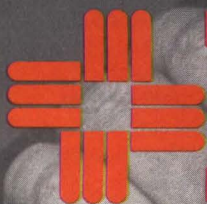

MODCOMP®

Modular Computer Systems, Inc., 1650 West McNab Road, P.O. Box 6099, Fort Lauderdale, FL 33310, (305) 974-1380

CIRCLE NO. 25 ON INQUIRY CARD

HEARD ON THE HILL

AI emerges from the shadows



By Stephen J. Shaw
Contributing Editor, Washington

Slowly but earnestly, companies in the artificial intelligence (AI) field are bringing out the tools to build the heralded Fifth Generation computer systems. It's likely to take several years for any AI-based products to have a major impact in the commercial market. But 1983 could be the year AI emerges from its R&D cocoon.

Many significant product developments are coming from recently formed companies devoted exclusively to AI. More than 20 new enterprises have appeared during the past two years, notes Louis Robinson, editor of *AI Reports* and former executive director of the American Association for Artificial Intelligence (AAAI). Those 20 enterprises form the vanguard of the nascent AI industry. That industry is devoted to revamping the relationship between humans and computers by developing systems that can perform logical inferences, draw on the knowledge of experts in specific applications and be accessed in "natural" languages—that is, in terms familiar to human operators.

Such AI systems were displayed and described at a recent five-day AAAI conference. Testifying to AI's broadening appeal, the conference attracted more than 2,000 participants, including 75 representatives of the general and trade press. More than 30 companies sponsored technical exhibits, and many more were represented on panels along with university and government research organizations.

There was a minor flurry of product releases at the conference from both computer industry bul-

warks such as Digital Equipment Corp. and Xerox Corp. and recent AI start-ups. But offerings aimed at further AI development applications outnumbered systems and programs for end-user applications. A broad range of strictly commercial AI products appears to be several years away.

"It's hard to build commercial products in any relatively new field of science," commented Larry Harris, president of AI Corp. "It's especially hard in AI because of the long development cycle, two to five years from prototype to product."

Harris told several hundred conference participants that more industry-specific products have just begun to be developed. He demonstrated AI Corp.'s Intellect software package, a general-purpose natural-language program that allows database access by entering conversational English onto a keyboard. IBM Corp. announced in June that it will include Intellect in its Information Center product line.

Other AI hardware and software products featured at the conference include:

- The Lambda system from Lisp Machine Inc. (LMI) offering both UNIX and LISP in 32- or 40-bit architecture. Instruction execution on the 68000 processor, which contains the Berkeley UNIX native software environment, can reach 1 million instructions per second (MIPS) with cache memory and a 10-MHZ processing speed. LMI also announced that Texas Instruments Inc. had acquired a 25 percent interest in LMI. The Lambda uses TI's NuMachine.

- General Electric Co. displayed a computer-aided troubleshooting system, the CATS-1 for locomotive-engine-repair applications. GE has placed the system in beta test at the Conrail and Burlington Northern railroads. The \$40,000 system incorporates a PDP-11/23 processor.

- DEC showed off the XSEL expert system that is not yet available commercially, says a DEC spokeswoman. It has been used successfully in-house to assist sales personnel in defining system configurations for customers. The XSEL system reportedly has helped DEC reduce the number of systems that is shipped in improper configurations, requiring follow-up sales calls and reorders.

- Symbolics Inc. began shipping its 3600 symbolic-processing system in June to customers including Bell Laboratories, GE, Mitre Corp. and Fairchild Industries Inc. Symbolics president Russell Noftsker estimates that the company has reached sales of \$3 million monthly, largely due to the 3600 system used as an R&D tool to develop AI expert systems.

- Another recent start-up, Inference Corp., introduced an inference engine, called ART, that can be combined with knowledge bases to construct a variety of expert systems. A license agreement has been reached with Control Data Corp. to use ART in CDC product development, states CDC company president Dr. Alexander Jacobson. Inference is attempting to reach a similar deal with DEC and is searching for a joint venture partner to develop an expert financial-system package.

***The Suit
and Chip proudly
debut their baby.***

***"To look at it, would you guess it has the
power of an IBM mainframe?"***

The Suit beckoned us closer. "For the VM/CMS users, and there are some 600,000 of them concentrated in big business, financial institutions and government, this little baby means new life for their existing programs and applications."



A 'personal mainframe' no less.

The Chip chimed in. "It is a personal mainframe that provides greater productivity for the individual user, enhances the performance of existing applications, leverages a company's investment in IBM systems and software, and provides access to sophisticated, modern computing environments such as FOCUS™ and RAMIS II™"

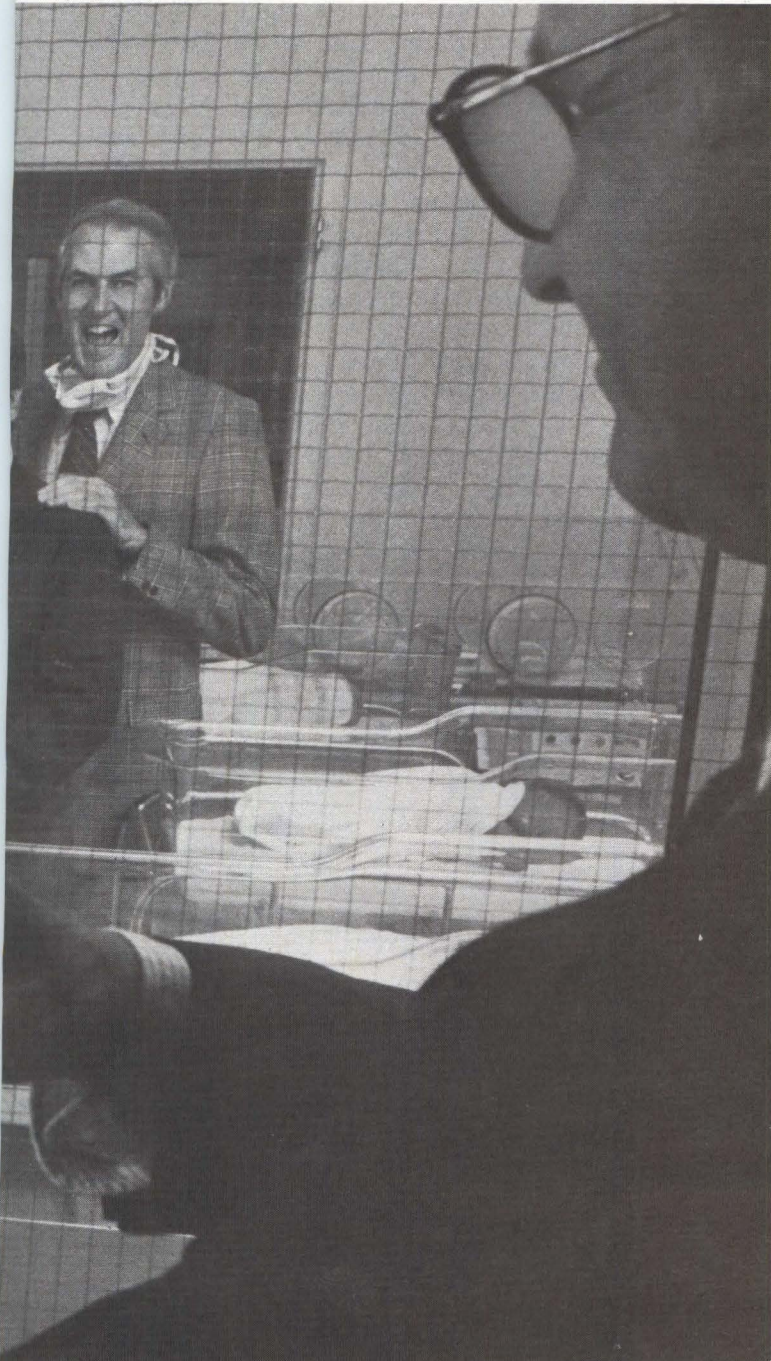

—and all at a price affordable by the single user.

We were talking with the Suit and the Chip at their new headquarters in Trumbull, Connecticut. They founded Canaan Computer Corporation in 1981. Prior to that, the Suit, Bob Bernard, was the founder of National CSS, a leader in the development of commercial time-sharing. The Chip, Nick Pisarro, was a major technical contributor there. We asked what makes the Canaan Computer stand out of the teeming mass of new computers.

CMS user freed at last.

"It's simple," explained the Suit. "Recent developments like multi-window graphics and Ethernet™ are giving some buyers of new computers vastly increased capabilities. But as far as the IBM mainframe user has been concerned, these new powers don't exist. The CMS user has had to be satisfied with decade-old technology. With the introduction of the Canaan Computer, that CMS user can now have it all."

Multi-window graphics, dedicated interactivity.

"What we have done," said the Chip, "is develop a machine that provides these state-of-the-art capabilities, and runs the user's IBM mainframe programs with no changes required. So, for the very first time, CMS users, or even non-users who want to take advantage of all that IBM software, can have very high-resolution graphics, networking for shared resources, super interactivity, more computing power than they can ever get on a shared centralized computer—and all in a package the size of a two-drawer file cabinet."

Multi-window graphics, local area networking, a dedicated processor for each user: is there anything else you want the business community to know, we asked?

"Yes," said the Suit. "Our address. So they can write or call for more information. Or to order a machine—they're ready for delivery now. It's Canaan Computer Corporation, 39 Lindeman Drive, Trumbull, Connecticut 06611 (203) 374-5592. Ask for the Suit."



CANAAN

CIRCLE NO. 26 ON INQUIRY CARD

Mini-Micro World

NEWS

Software protection again under review; Apple aces Franklin

As a federal court of appeals issued a ruling favoring Apple Computer Inc. in its fight with Franklin Computer Corp. over software copyright infringement, the Copyright Office of the Library of Congress was reviewing industry suggestions on how to improve procedures and protect trade secrets for copyright registration.

Under current procedures, software programs are available for public inspection during review procedures preceding copyright and once copyright has been granted. The public can inspect software programs either by browsing through the Copyright Office's

massive files or directly through the Freedom of Information Act. Industry comments filed in response to a Notice of Inquiry (NOI) Docket RM83-4 urge tighter access restrictions and more leeway in how the programs are filed for registration. The current registration methods, many of the comments claim, only reduce the number of software copyright applications because the software suppliers choose to rely on the protection offered by the Trade Secrets Act rather than risk revealing proprietary information through the copyright process.

Under state common law, the courts have upheld an individual's

or organization's right to protect proprietary information. However, infringement of trade secrets is sometimes difficult to prove when a product is widely marketed and when no contract exists between disputing parties, states Michael Keplinger, policy planning advisor at the Copyright Office. Remedies for trade-secret infringement vary from state to state. Copyright protection was explicitly extended to computer software programs in 1980 in an amendment to the Copyright Act of 1978. The Copyright Office usually requires submission of programs in two forms: source code—high-level and assem-

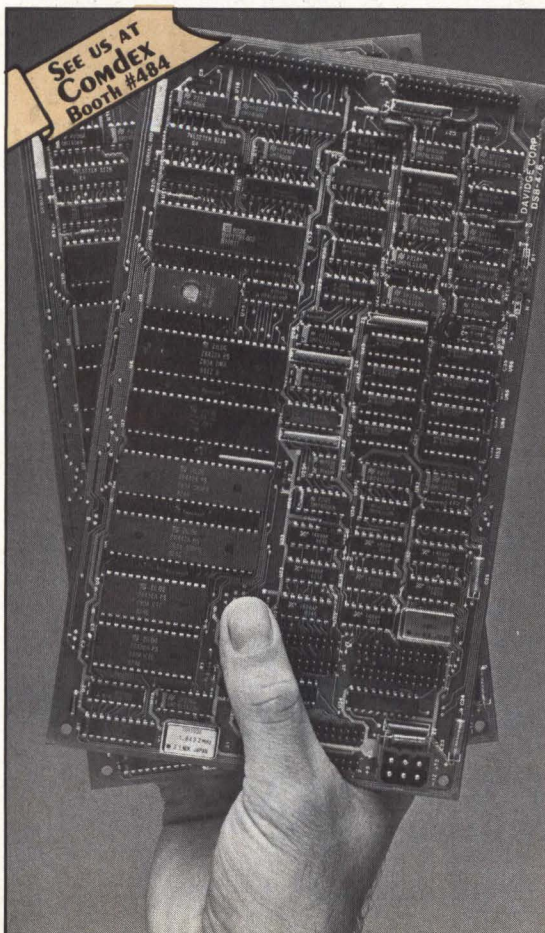

OUR GUTS YOUR GLORY

POWERFUL SINGLE BOARD COMPUTERS FOR OEMs FROM DAVIDGE

- 4MHZ Z80A OR 6 MHZ Z80B
- 64K, 128K, Expandable to 256K
- DMA Controlled: 5 1/4" and 8" floppy disk controller SASI Interface (for hard disk) High-speed bi-directional parallel port
- 2 RS232-C Serial Ports Expandable to include: 2 RS232 serial ports 2 RS422 serial ports IEEE 488 GPIB parallel port
- Centronics parallel printer port
- Davidge utility software
- CP/M 2.2, 3.0, MPM-II, CP/NET*
- BASIC, Pascal, C, FORTH, plus others

Build With Excellence
Davidge lets you

combine a variety of hardware and software features to produce powerful and cost-effective single and multi-user systems. OEMs and systems integrators have the design advantage because these single board microcomputers are compact in size and offer a full range of options to meet virtually any applications challenge. Our low prices are your competitive edge.

SOFTWARE SUPERIORITY

Davidge's easy to use utility software allows you to define system parameters directly from your terminal. Forget the inconvenience of rewriting and compiling code each time you reconfigure the system for different peripherals. The utility software

queries you, in English, to let you change system parameters for specific applications. The system software also allows automatic interface with both 5 1/4-inch and 8-inch floppy drives simultaneously in either single or double density recording formats.

SMALL SIZE, HIGH PERFORMANCE

The Davidge single board microcomputers measure a trim 5.75" x 10". Having the CPU, memory and I/O devices all on one board combines high system performance with extremely good reliability.

Build your systems with excellence. Call Davidge today to review our fine product selection and low OEM pricing.

Davidge

415-964-9497

1951 Colony Street, Suite X
Mountain View, California 94043

Ask about our private label microcomputer systems.

*Z80 A/B are trademarks of Zilog, Inc. CP/M, MPM-II and CP/NET are trademarks of Digital Research, Inc.

A Complete Graphics Department For Just \$2295



Realize day-in and day-out solid performance from a quiet and capable desktop plotter. It's true. For only \$2295* the Houston Instrument HIPLØT™ DMP-29 will provide you with world-class multi-color hard copy graphics, and deliver a level of quality and performance that you would expect in a plotter costing three times as much.

It's a hard worker. The DMP-29 goes about its job with amazing speed and precision. Unbeatable resolution and repeatability are yours in both 8½" x 11" and 11" x 17" formats, and 8-pen capability assures you of fast attention-free flexibility when multi-color output is required. High pen speed combined with an addressable resolution of 0.001" assures fast, accurate and stepless traces.

It's friendly. You can call 21 different functions directly from the front-panel membrane keyboard. It's tolerant too. The DMP-29 will modestly protect itself from user errors, as when attempting to place a pen in an already occupied stall.

And it's smart. An extensive set of firmware routines makes life easier for the user. A small sampling of the built-in talent inherent in the DMP-29 includes character generation, circle, arc and ellipse synthesis, line type variations, viewport/windowing, clipping and scaling.

For the name, address and phone number of your nearest distributor/dealer, write Houston Instrument, 8500 Cameron Road, Austin, Texas 78753. Phone 512-835-0900, or 1-800-531-5205 if outside Texas. In Europe contact Bausch & Lomb Belgium NV., Rochesterlaan 6, 8240 Gistel, Belgium. Tel 059-27-74-45. Tlx 846-81399.

BAUSCH & LOMB 
houston instrument *division*

* U.S. Domestic price only
™ Trademark of Houston Instrument

CIRCLE NO. 28 ON INQUIRY CARD

4PO05B

Mini-Micro World

NEWS

bly languages—and the first and last 25 pages of a program's printout. The 25-page requirement, notes Keplinger, was devised in 1980 to protect programs for mainframe computers; for shorter minicomputer and microcomputer programs, now being filed in larger volumes than ever, the requirement to submit the 50 pages can mean that the entire program printout must be submitted in the relatively easy-to-read source code.

Copyright applications can also be submitted in object code—statements in the "01" format of machine language. The Copyright Office accepts all software programs for registration. They must be accompanied by a written statement from the author testifying to the program's original content, but the

Copyright Office makes no claim as to authorship authenticity.

The NOI is designed to elicit industry opinions to help solve the dilemma now plaguing Copyright Office computer specialists: "How do we accept software without allowing public access to the material?" asks Keplinger. With approximately 2,000 software programs submitted each month, the Copyright Office is also attempting to avoid inadvertently abetting software pirates.

Manufacturers of video games feel the effects of the software-protection issue most keenly. Atari Inc. advocates that the copyright agency accept object code and a portion of the source code embodying an extract from the graphics display. "If Atari were required to

disclose source codes as a condition of copyright registration, we would be forced to choose between sacrificing our trade-secret rights on the one hand or sacrificing our copyright remedy on the other," Atari stated in its comments to the NOI.

Some small software engineering companies have flatly refused to seek copyrights, preferring to forgo the legal remedies against infringement available under copyright rather than risk their trade secrets. "We have never sought a copyright on any of our software because we refuse to make our source code available...and we have approximately 500,000 source-code lines," commented AAA Technologies and Specialties Inc., Houston.

Manufacturers' trade groups,

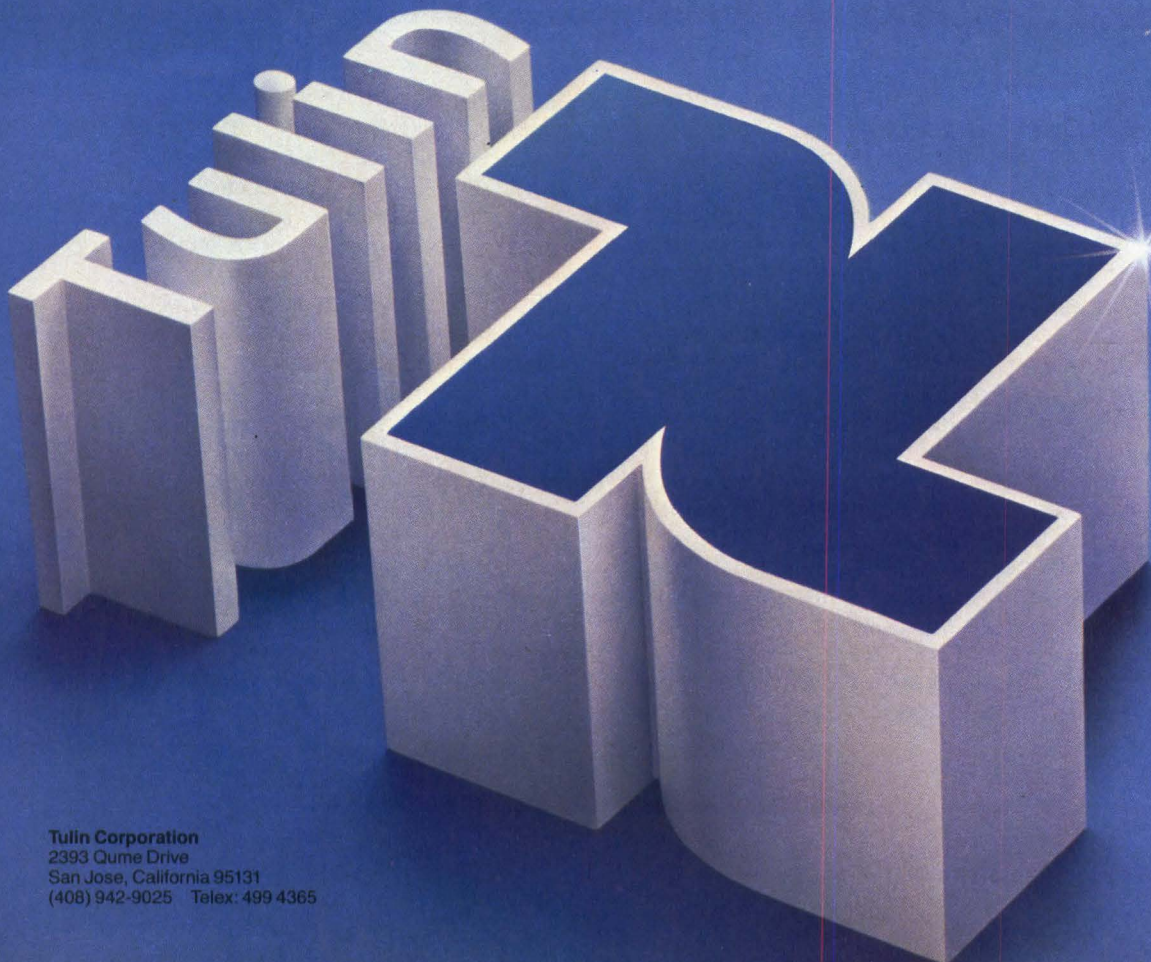

Tulin Corporation
2393 Gume Drive
San Jose, California 95131
(408) 942-9025 Telex: 499 4365

CHARACTERISTICS OF PROTECTIVE MECHANISMS

Considerations for software	Copyright	Patent	Trade secrecy
Consistency with other copyright areas?	Yes	No	No
Availability of protective mechanisms for some programs? ¹	Yes	Unclear	Yes
Universal availability of protective mechanisms for all programs? ²	Yes	No	No
"Process" protectible?	No	Yes	Yes
Suited for mass distribution?	Yes	Yes	No
General considerations			
National uniformity?	Yes	Yes	No
Protection effective upon	Creation of work	Successful prosecution of applications	Entrance into contractual relationship
Cost of obtaining protection	None	Moderate	Moderate
Term of protection	Life + 50 years or 75 years	17 years	Possibility of both perpetual protection and termination at any time
Cost of maintaining protection	None	None	Significant
Cost of enforcing rights against violators	Moderate	Moderate	Higher
Protection lost by	Gross neglect	Unsuccessful litigation	Disclosure

¹Serious doubt exists about whether programs are proper subjects for patent protection.

²Even if programs are patentable, only those that are truly novel and non-obvious are protected. Trade secrecy is unavailable when the contents of a program have been disclosed.

Source: Final report of the National Commission on New Technological Uses of Copyrighted Work, Library of Congress, 1979.

A Platter Ahead in Half-Height Winchester

Tulin fits your data storage needs with half-height Winchesters storing 13.34, 26.7 and 40 megabytes (unformatted). But Tulin gives you more than big capacity in a little space. Tulin gives you a higher level of technology, better reliability, and more proprietary features.

Formed by leading Winchester technologists, Tulin is backed by the resources of one of the world's largest electronics companies. So don't be afraid to order your evaluation units now. We're ready to show that Tulin fits in your system.

Features: Capacities of 13.34, 26.7 and 40 megabytes (unformatted). ■ One/two/three platter design for more capacity now and later. ■ Half-height design. (Mount two in one minifloppy cavity.) ■ Inside hub spindle motor saves space. ■ Heat dissipation—only 15 watts ■ Standard ST506/412 interface ■ Dedicated head landing/shipping zone ■ Rotary actuator has only one moving part. ■ R/W head preamp inside head disc assembly for better signal to noise ratio and better protection from RF interference. ■ Automatic spindle brake and actuator lock

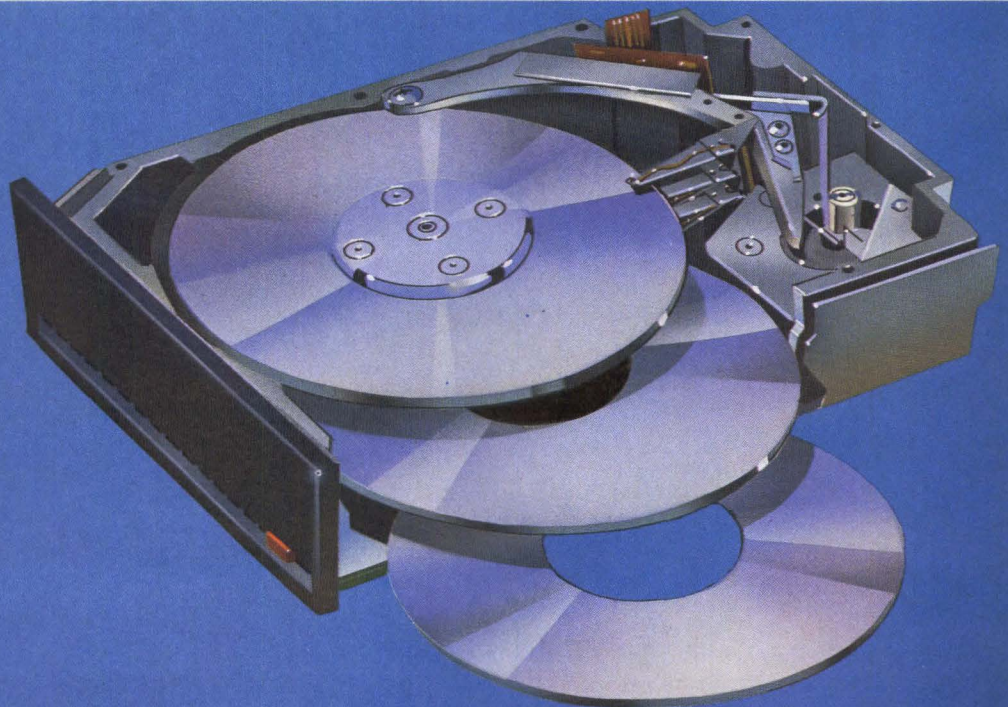

13.34 MB

26.7 MB

40 MB



TULIN FITS IN.

CIRCLE NO. 29 ON INQUIRY CARD

See us in the West Hall, Comdex

Mini-Micro World

NEWS

including the Computer and Business Equipment Manufacturers Association (CBEMA) and the Association of Data Processing Service Organizations (ADAPSO), urged that a "secure deposit" procedure be implemented. ADAPSO called on the Copyright Office to retain only a

small identifying portion of the source code, such as a diagonal page strip. CBEMA proposed eliminating public access to copyright applications during review.

In the Apple-vs.-Franklin case, the Third Circuit Court of Appeals in Philadelphia overturned a lower

district court's decision not to impose an injunction against Franklin to stop the Cherry Hill, N.J., manufacturer of Apple-compatible systems from selling 14 operating-system software programs Apple claims are protected by its copyright. The appeals court remanded the case to district court with instructions to consider the computer software fully protected under Apple's copyright. "Copyrightability of computer programs is clearly established after the 1980 amendment to the Copyright Act," said the court in its opinion.

The decision also chided the earlier ruling for its uncertainty about whether a software program in object code could be considered the same as a "literary work" for copyright protection. The court also rejected Franklin's assertion that the programs in question—operating-system software—were specifically excluded from copyright protection.

The medium through which the software program is expressed does not alter the available copyright protection either, according to the court. Franklin had argued that programs impressed on ROM devices are not subject to copyright.

Predictably, Apple was cheered by the decision. The company is aggressively pursuing companies it believes are infringing its copyrights. Recent victories have been secured in France, Germany and the Netherlands. "We're naturally pleased and gratified by the decision," comments an Apple spokeswoman. "It's good not just for us but for independent software writers."

Franklin intends to continue its defense at the district court level, says company president Joel Schusterman, with other issues that were not considered by the appeals court.

—Stephen J. Shaw

Computer Supplies for Rural America



Pryor is the easy way to order top quality computer and word processing supplies, no matter where you are. We offer a full line of supplies, from work stations and



cables to dust covers and even screen glare filters...over 1600 items in all...and everything's in stock. You can expect instant turnaround of all orders, even overnight express if you wish.

PRYOR

Full line computer supplies since 1959

Over 67,000 customers rely on Pryor every day.
Call toll-free for your own catalog now.

Ext. 5046 **1-800-558-6866**

CIRCLE NO. 30 ON INQUIRY CARD

NO BAD MEMORIES

If buying magnetic media from the other guys has given you some bad memories, maybe you should be doing a lot more business with us.

Your customers are beginning to ask for OPUS by name because of the unheard of reliability we build into all our memory products — flexible diskettes, single-disk cartridges, multi-level disk packs and magnetic tape.

Dealers are remembering us because of our margins. The profits you'll make from selling OPUS are second to none, and frankly, better than most.

Besides our great product and generous margins, remember that we accept orders of all size, with virtually no restriction on how little or how much you can buy. And when you order from OPUS, we deliver what you need, when you need it.

Find out more. Circle us on the reader service card, or call or write.

Computer Resources, Inc.
4650 W. 160th Street, Cleveland,
Ohio 44135. Phone: 800/321-9330.

See Us At
 **COMDEX**[™]
Booth 2531

OPUS[®]
NO BAD MEMORIES



DATA GENERAL INTRODUCES THE DESKTOP GENERATION.



Whatever your requirements, the DESKTOP GENERATION™ offers the solution—whether it's for you or your customers. It's the only family of desktops to open up the worlds of technical and industrial automation, data processing, information management and personal automation.

With a range of capability, power and functionality that far exceeds that of the most popular personal computers, the IBM PC family.

THE WIDEST RANGE OF COMPATIBILITY

For example, take operating systems.

The DESKTOP GENERATION's dual architecture (based on a Data General microECLIPSE™ processor and an 8086) permits it to run 5 operating systems. And it can run two concurrently.

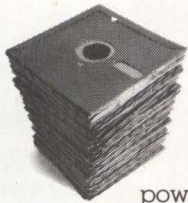

It accepts both popular micro-based operating systems (CP/M-86, MS-DOS) as well as three of Data General's widely-used operating systems (AOS, RDOS, MP/AOS).

And, as a technical/scientific workstation, the DESKTOP GENERATION is powerful enough to run software packages for almost any application you or your customers might have in mind. Including those for mechanical and electrical engineering, architectural drafting and analysis, real time control, project management, or anything else.

Moreover, the DESKTOP GENERATION is compatible with everything in the Data General line: from the NOVA®, to the microNOVA®, to the ECLIPSE® and entire 32-bit MV family.

The leading personal computer vendor has no other products which are compatible with its PC. Period.

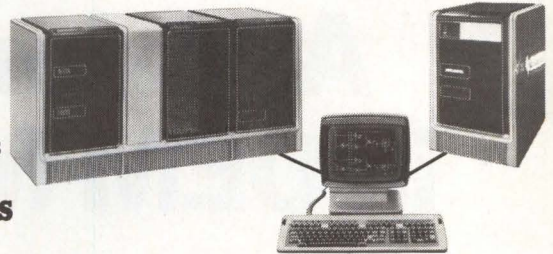

THE BEST COLOR GRAPHICS

Or, take graphics resolution.

The DESKTOP GENERATION has eight times the resolution of the leading personal computer: 640 x 240 versus 160 x 100. With a palette of 4096 colors versus a limit of only 16.

THE WIDEST RANGE OF MEMORY AND PERIPHERALS

The DESKTOP GENERATION has three times the memory expansion (up to 2 MB) versus 640 KB on their PC.

It offers more disc (30 MB maximum disc storage). Plus a 15 MB cartridge tape for fast backup which that other PC doesn't have. And Data General has a greater choice of peripherals and options, including mouse, tablet, ten-color plotter, monochrome printer, graphical kernel system (GKS) software, and IEEE-488 interface.

WIDEST RANGE OF GROWTH OPTIONS

In summary, the DESKTOP GENERATION offers you a full product line. With snap-on modules and user installable features. The ability to grow your stand-alone system into a full network with a range of communications products. And the ability to take your single-user workstation and turn it into a multi-terminal system.

BEST PRICE

Best of all, you get this for a price that's comparable to that of the most popular personal computers.

And, as a bonus, you get a support system that includes a choice of 16 service plans. Plus the only online software update service available for desktop systems.

CALL NOW

To get more information on the DESKTOP GENERATION family, call this toll-free number:
1-800-554-4343, Operator 06.

Or send us this coupon today:

CIRCLE NO. 32 ON INQUIRY CARD

DESKTOP GENERATION is a trademark of Data General Corporation.
CP/M-86 and MS-DOS are registered trademarks of Digital Research Inc. and Microsoft Corp., respectively. Copyright 1983 © Data General Corporation, Westboro, MA.

Data General, M.S. F134, 4400 Computer Drive, Westboro, MA 01580.

I'm an OEM End User

I'm interested in:

- Industrial automation System software Application software
 Small business systems Graphics Other _____

Name _____

Title _____

Company _____

Telephone _____

Address _____

City _____

State _____

Zip _____

 **Data General.**
a Generation ahead

THE CODATA DIFFERENCE

A Major Improvement in OEM Microcomputers.

With so many microcomputers on the market, and with each manufacturer claiming to have the solutions to everyone's problems, why are more and more OEM users choosing CODATA 3300 works!

Very simply because the CODATA 3300 works!

That's an important part of what we call THE CODATA DIFFERENCE—a refreshing, new concept in OEM marketing.

More performance... Lower price... Extended warranty.

We've increased the performance of the CODATA 3300 and, at the same time, we've lowered the price. That means our CODATA multi-user, multi-tasking 16-bit computer systems have price/performance ratios nobody else can match. We're so confident in our system's integrity that we've extended the warranty on every CODATA 3300 to 180 days. That's the longest war-

ranty in the business and, let's face it, you've got to be pretty sure of your product to guarantee it for six full months. We're sure.

These are more elements of THE CODATA DIFFERENCE.

An uncomplicated pricing policy.

We have only two price sheets: one for suggested retail, the other for OEM prices. Simple, straightforward, easy-to-understand. Beyond that, there are no quantity commitments, no bill-backs, no hassles.

Full support and technical assistance if needed.

Our customers select the CODATA 3300 because it fulfills their needs, because it does what we say it will do, and because we have taken great pains to assure that it is functionally simple and capable of performing its

assigned tasks with no problems. But, if technical support is required it's only as far away as your phone and available at a moments notice via our TOLL FREE number during normal business hours in every U.S. time zone.

A multi-user, 33-megabyte system for only \$9,600.

The CODATA 3300 is a powerful 16-bit, 68000-based, MULTIBUS system that can effectively accommodate up to ten users. It's a complete UNIX system that runs full ANSI standard FORTRAN-77, RM/COBOL, BASIC+, SMC BASIC, APL, and PASCAL. The 3300 provides up to 33 megabytes of unformatted on-line storage via an integrated, high speed Winchester drive, and a removable, quad-density 5¼" floppy disc system. The 3300 features 320 K bytes of parity protected RAM.

An expanded CODATA 3300, with 84 megabytes of disc storage, is priced at \$13,500. The 3300 is also available as a 12-megabyte system for as low as \$7,800.

LET US SHOW YOU THE CODATA DIFFERENCE.

Write or call us for more information.

CODATA SYSTEMS

285 North Wolfe Road
Sunnyvale, CA 94086
1-800-521-6543
In California: 1-800-221-2265

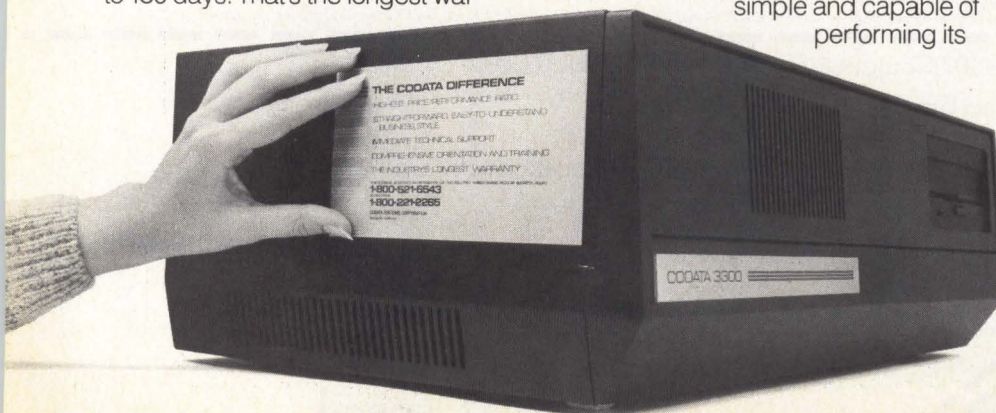

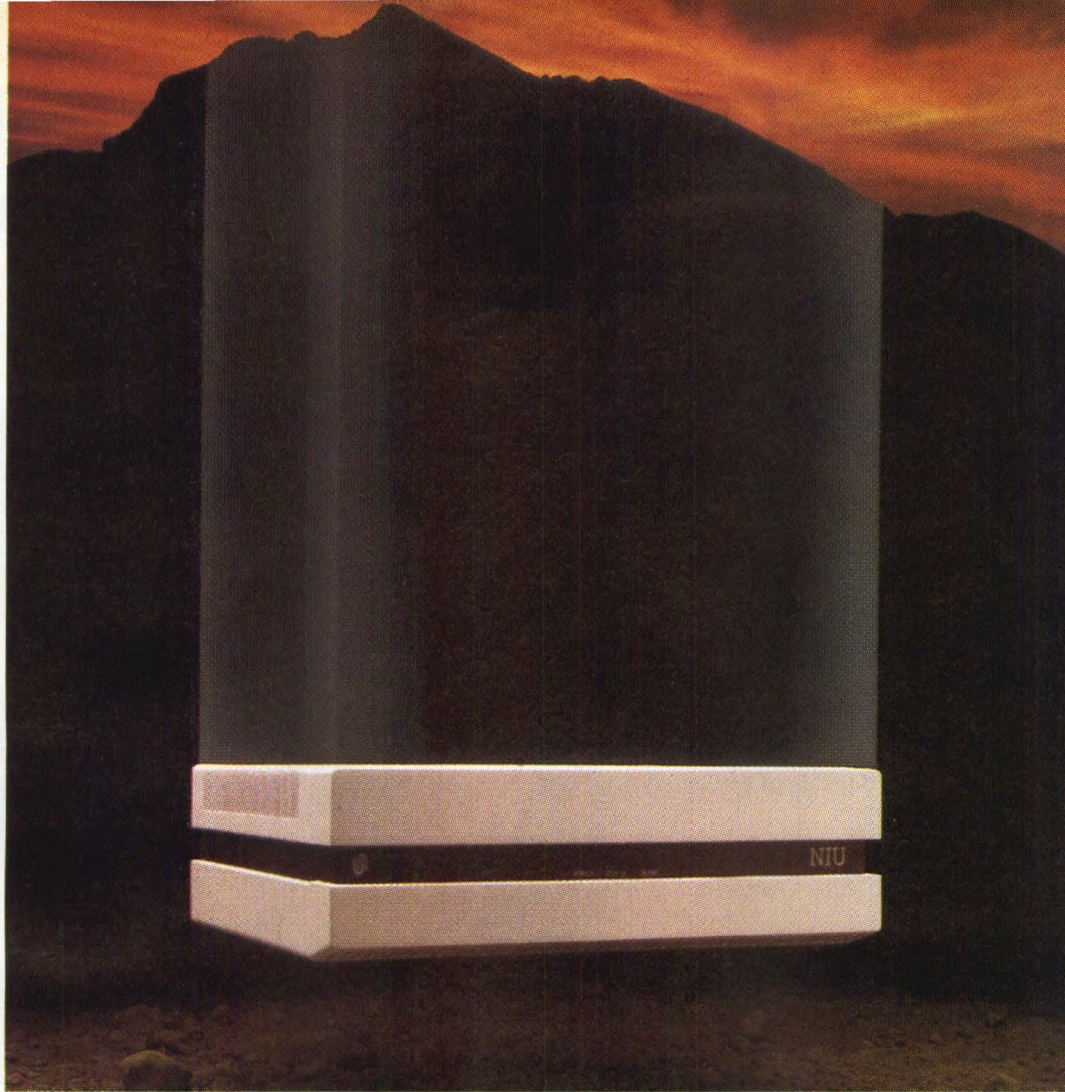

Now, a major advancement in Net/One local area networking. Lower cost.

Our new VLSI chip set has allowed us to do with one printed circuit board what we used to do in three. The result is a new Network Interface Unit, the NIU 150, that's half the cost of its predecessor, the NIU-1. In areas where a smaller number of either broadband or baseband connections are required, the pared-down NIU 150 brings per-port connection costs well below \$500.

Streamlined NIU 150's mean more flexibility, too, by serving small equipment clusters in more diverse locations at a lower cost.

Like our other Network Interface Units, the new NIU 150 is equipped, off the shelf, to support most industry-standard equipment interfaces. And like our other NIU's it comes with complete network services software. It's also programmable,

so special interface protocols can be added now or anytime in the future to support special equipment.

The broadband version of our new NIU 150 has an integral modem. Both baseband and broadband NIU 150's can accommodate up to six ports for device attachment.

Give us a call, or write for more information about turning the equipment you have now—whatever it is—into the network you need now, at a lower cost than was possible before.

Ungermann-Bass, Inc., 2560 Mission College Boulevard, Santa Clara, California 95050.
Telephone (408) 496-0111.

Net/One from Ungermann-Bass 

© 1983 Ungermann-Bass, Inc.

Net/One is a registered trademark of Ungermann-Bass.

MINI-MICRO SYSTEMS/ November 1983

CIRCLE NO. 34 ON INQUIRY CARD

The Newest Innovation in Controller Technology From the Oldest Name in Multifunction Controllers.

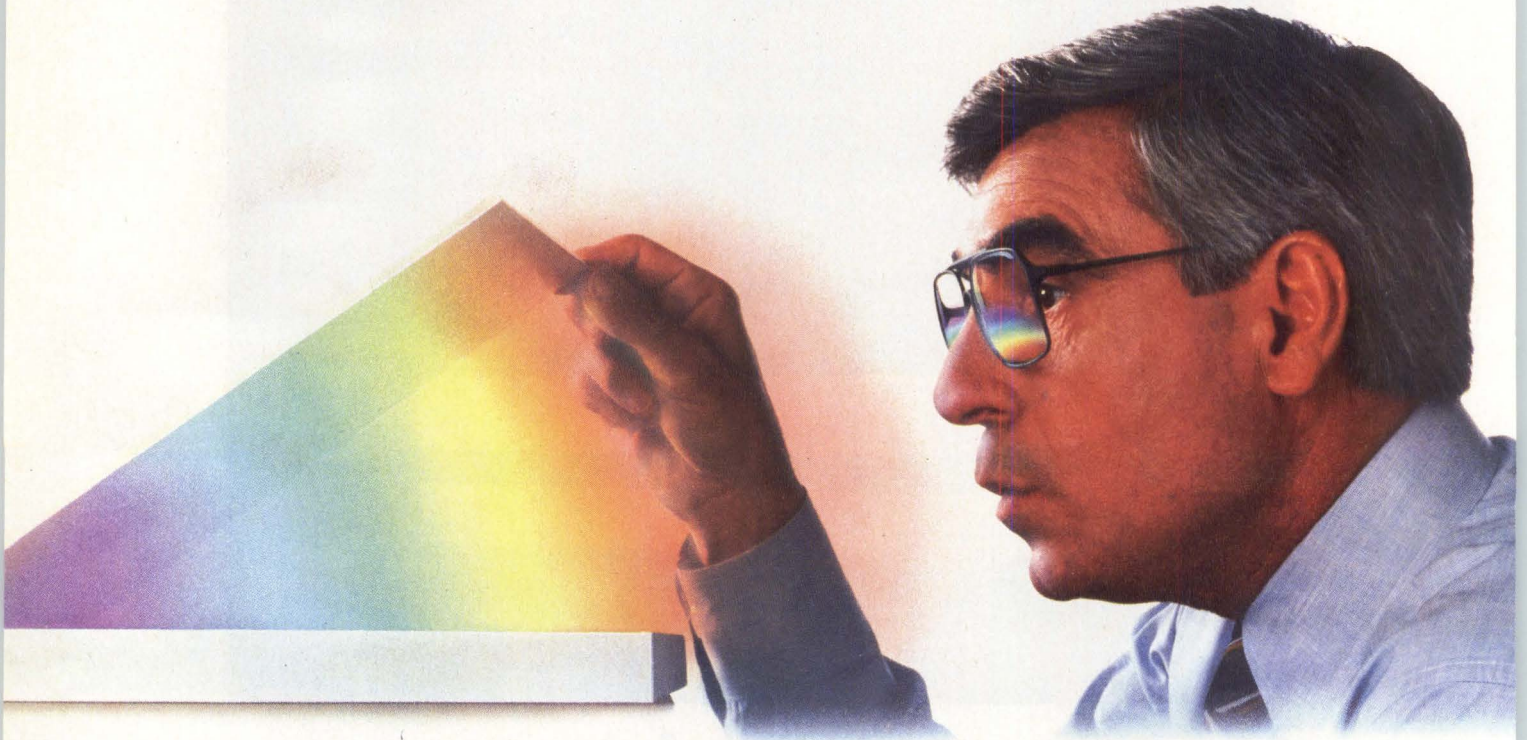

Introducing the World's First LSI-II Emulating Multifunction Disk/Tape Controller.

Say hello to SPECTRA 25, the cornerstone of our new family of high-performance disk/tape controllers designed for use with DEC's LSI-II computer.

This revolutionary Q-Bus compatible single quad board lets you interface any combination of two SMD disks and four formatted 1/2-inch tape drives. By using extended commands to program the onboard E²PROM, you can easily select drive mixing, mapping, and many other features—all without removing the controller from the system.

The SPECTRA 25 emulates DEC's RM02/5 and RM80 disk subsystems, and DEC's TSII tape subsystem. It also provides complete emulation for operation with DEC's RT-II, RSX-IIM, RSX-IIM-PLUS and RSTS/E operating systems.

To further enhance system performance, Spectra Logic offers SPECTRA STREAM™ software, a streaming tape backup utility that can back up an entire 80MB drive in only seven minutes.



Spectra Logic first introduced the multifunction concept back in 1979. And we've been quietly revolutionizing the market ever since with families of controllers that provide the high-performance, proven reliability, and added value you need to stay competitive.

We also offer the industry's most comprehensive one year warranty, responsive nationwide service, and ongoing technical support.

SPECTRA 25 is the latest innovation in controller technology from the company with peripheral vision. Spectra Logic. For further information, including complete technical specifications, call or write us today.

Spectra Logic Corporation
1227 Innsbruck Drive, Sunnyvale, CA 94089
(408) 744-0930 TWX 910-339-9566
TELEX I72524 SPL SUVL

International Sales Office:
Belgium (32) (2) 5134892

Please see us at Comdex Booth No. 3174

CIRCLE NO. 35 ON INQUIRY CARD

SPECTRA LOGIC

Mini-Micro World

CORPORATE AND FINANCIAL

Osborne Computer self-destructs

Osborne Computer Corp., the Hayward, Calif., pioneer in popularizing portable computers for business, apparently fell victim to its own arrows in mid-September. Rapid market success but few cost controls led to a series of layoffs ending Sept. 9 leaving only 75 paid employees, down from 1,000 in Osborne's heyday. Four days later, unable to locate a cash-rich suitor to acquire it and having a \$4.5 million lawsuit threatened by two creditors, Osborne filed for Chapter 11 bankruptcy protection.

Consumers saw the company's Osborne I portable computer as the Volkswagen of personal computing—not beautiful but a great bargain. Considered the first reasonably affordable full-featured portable computer, the Osborne I included bundled programs whose retail price exceeded the combined price of the product's hardware and software. About 120,000 Osborne I

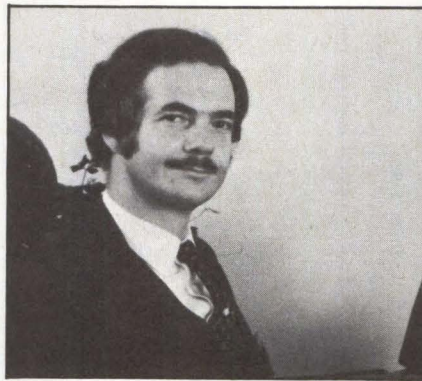

Adam Osborne, founder and chairman of Osborne Computer Corp. and a pioneer in portable computers, was readying to follow the leader with an IBM-compatible portable, the Executive II, when his company was forced to file for Chapter 11 bankruptcy protection.

units have been sold, notes Tom Hayes, product manager for Osborne's recently introduced Z80A-based Executive I system. Hayes adds that 15,000 Executive I's have been sold.

Since last spring, Osborne had

laid off 384 employees, closed its New Jersey production plant and severely reduced overseas operations. Analysts believe the layoffs and closures were caused by poor sales related to product delays, system reliability problems, slow and inaccurate reactions to the booming portable microcomputer market and a series of premature product announcements. "They [Osborne] underestimated the importance of IBM compatibility and KayPro's capabilities both in manufacturing and sales," opines John R. Kiefer, senior analyst at InfoCorp, a Cupertino, Calif., market research company. InfoCorp figures show Osborne dominated the transportable computer market until this year. In 1982, Osborne shipped about 73,000 units. This year, 27,000 units were shipped in the first half. The year is expected to top out at less than 40,000 units, according to InfoCorp. KayPro, meanwhile, doubled last year's shipments to 40,000 by midyear, an amount expected to more than double again by year-end.

In January, company founder and chairman Adam Osborne hired Robert Jaunich, formerly of Consolidated Foods, as president and chief executive officer to run the daily operations of the company. At the time of Jaunich's hiring, a former employee claims, overemployment was a problem, and financial controls were virtually nonexistent. Osborne also announced plans to go public in March. Both strategies to save the company failed. Osborne's false start on the stock market signaled something was wrong. And, states one insider who asks not to be named, Jaunich's appointment was the final blow to employee morale. "Up to then, Osborne was a lot like the little train that could. Everyone's spirit was really high, and things got done because you believed they could be

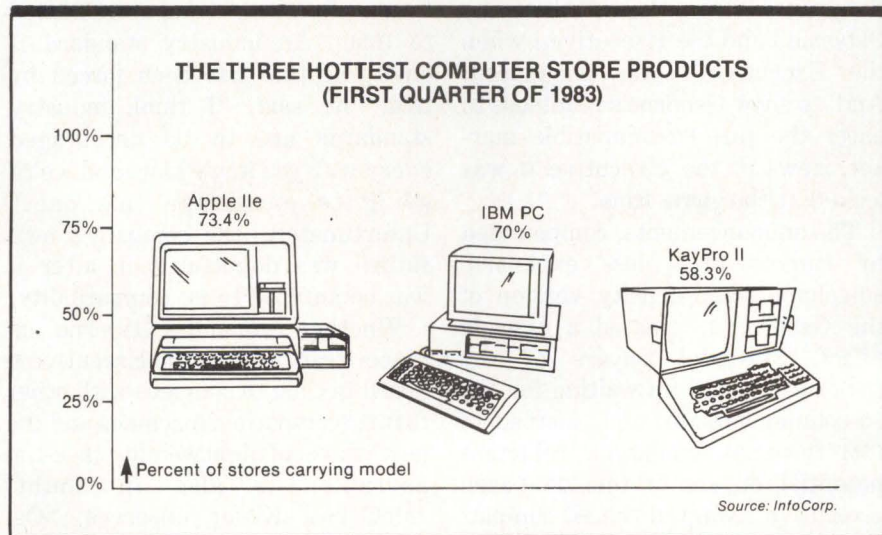

InfoCorp's first-quarter 1983 computer store survey shows Osborne missing from the hottest product trio in stores. Other InfoCorp studies list Osborne second that quarter as most frequently mentioned by stores as having lower than expected sales and contributing to an inventory overstock. Osborne was simultaneously undergoing a top management change to control costs and employment and was preparing to go public and to usher its follow-on products to market.

Mini-Micro World

CORPORATE AND FINANCIAL

done. But, when Jaunich came on board, he went around saying, "You're not doing that right," and suddenly, things started falling apart," says the source.

When Jaunich joined the company, he found enough problems to chill the hopes of even an inveterate optimist. Despite revenues approaching \$100 million, Osborne reportedly never had a period of substantial profits. Vice president of finance Donald Waite will not confirm these reports. Financial controls were established, but the company's other problems remained.

Almost from the beginning, Osborne suffered from a series of premature, overly-optimistic announcements, usually emanating from Adam Osborne himself. The company promised owners of early Osborne I's with single-density disk drives that upgrading to dual-density versions would take two weeks, but they typically had to wait months. Adam Osborne says there were problems with new disk drives; the electronics of some of the oldest systems had to be almost completely rebuilt, resulting in nearly new disk subsystems.

Much more devastating than the upgrade delays were the ill-timed March and April announcements of the Executive I and II portable computers and a high-level leak concerning the never-officially-announced Vixen, described as a smaller, lighter 80-column-display version of the Osborne I. The Executive I and II each have 128K bytes of memory and 7-inch amber monitors. The Z80A-based Executive I features IBM terminal emulation. The IBM PC-compatible Executive II was to include Z80A and 8088 processors.

Many analysts believe that neither the Executive I nor II should have been announced until their

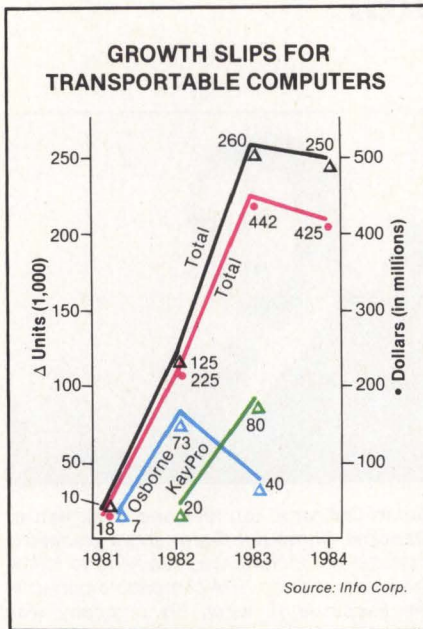

Transportable computer growth is expected to peak this year. Nonetheless, KayPro still is expected to grow in relation to former leader Osborne Computer Corp., which InfoCorp estimates shipped 27,000 units until mid-1983. Growth then slowed to yield an estimated yearly total of less than 40,000 units shipped.

production was ramped up and Osborne I production was ramped down. But the company believed there would be markets for both the Osborne I and the Executive I when the Executive I was announced. And, to show Osborne's readiness to enter the IBM PC-compatible market, news of the Executive II was leaked at the same time.

The announcements, compounded by rumors of a less expensive 80-column, dual-density version of the Osborne I, created a cascade effect. Potential buyers of the Osborne I ended up waiting for the 80-column version, and, instead of IBM terminal emulation, reluctant potential buyers of the Z80-based Executive I wanted the PC-compatible, 8088-based Executive II.

Despite a promise from product manager Hayes that when the Executive I was introduced the new product would immediately arrive

in production quantities, production delays lengthened, aggravating the situation. Egil Juliussen, an analyst at Future Computing Inc., a Richardson, Texas, market research company, confirms delayed production of the Executive I, noting, "There was no cash flow [at Osborne] for several months." Sales in April were virtually non-existent. In the meantime, other manufacturers such as KayPro, Compaq Computer Corp. and Morrow Designs Inc. took the lead in low-end, full-featured personal systems away from Osborne.

As recently as Sept. 6, Osborne was confident and enthusiastic about the Executive II, claimed by Adam Osborne to be the "most compatible" of the IBM PC compatibles. Both Adam Osborne and Jim Schwabe, product manager for the Executive II, say the company had successfully tested as many as 40 MS-DOS programs on the Executive II, including heavily graphics-oriented programs such as Flight Simulator and Lotus 1-2-3.

Recently, Osborne described the future of personal computers as tied to IBM. "An industry standard is emerging that has been forced by IBM," he said. "I think industry standards are to be encouraged every way you know how, and we're going to encourage this one." Unfortunately, the company's own future was doubtful soon after it was committed to PC compatibility.

Whether remaining Osborne engineers can develop the Executive II board in time to compete with other IBM PC-compatible machines and the new wave of lightweight knee-top portables is also in doubt. InfoCorp's Kiefer observes, "Osborne, in cutting expenses, may have cut the R&D budget too quickly [as money began running out in April], which will affect their competitive posture on future

MUMMS THE WORD.

When you visit the Seagate booth at COMDEX, you'll agree that MUMS™ is the most significant new disc drive product announcement since Seagate introduced the first 5¼" Winchester in early 1980.

Here's high capacity data storage for today. Fast. Compact. Reliable. Affordably priced. From Seagate, the company that doesn't compromise on quality.

See Seagate at COMDEX, booth # 4324. You'll agree that MUMS the word.

"Turning the tide in disc technology"

Seagate



See us at COMDEX Booth No. 4324.

920 Disc Drive, Scotts Valley, CA 95066, (408) 438-6550, TELEX 176455SEAGATESCVL

©1983 Seagate Technology. MUMS is a trademark of Seagate Technology.

CIRCLE NO. 36 ON INQUIRY CARD

ACCESS TIME: ONE WEEK.

Our competitors promise so much. And deliver so little.

Not ATASI. In the last three months, we've shipped more high performance 5¼" drives than all our competition *combined!*

If you're an integrator of multi-user systems, LANs or workstations, ATASI has what you need: 5¼" drives offering an access time of 30ms... 46Mb capacity... rugged design... faster throughput... and delivery that puts time on your side.

To see how fast we really are, call 408/995-0335, or visit us at Comdex (booth 6114) and help us celebrate the shipment of our ten thousandth drive!

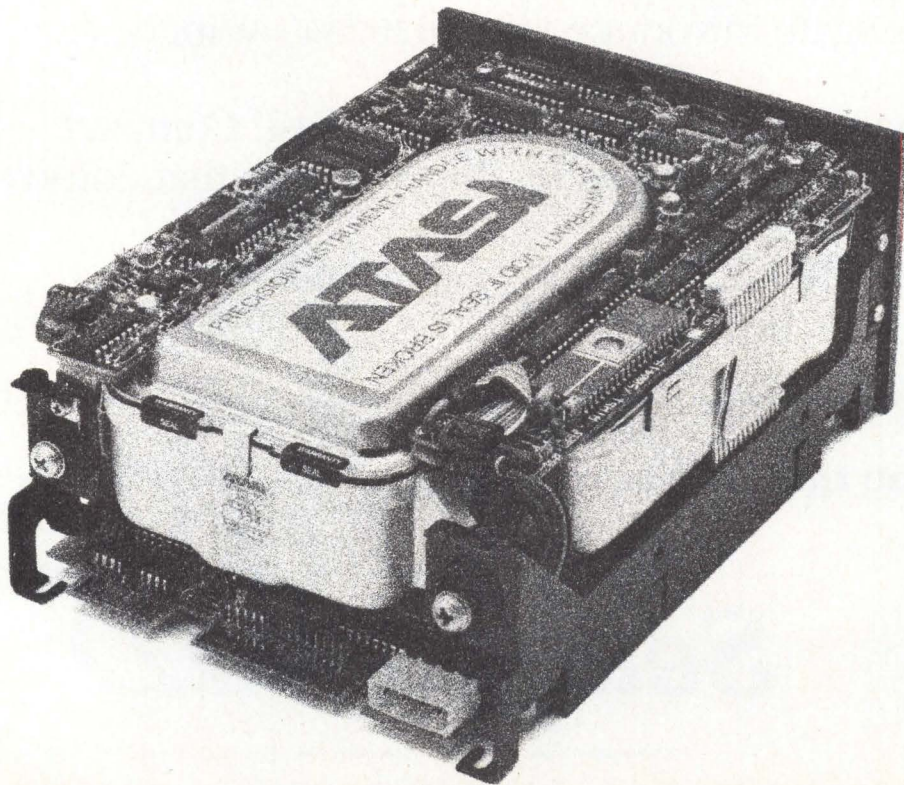

ATASI

ATASI Corporation
2075 Zanker Road
San Jose, CA 95131
408/995-0335

Mini-Micro World

CORPORATE AND FINANCIAL

products." InfoCorp's market projections show that, "after the early dramatic growth, we see the transportable market shrinking because of the increasing power of the Gavilan-, Grid- and Sharp-type lightweight computers," he adds. InfoCorp's figures indicate that annual unit and dollar sales for

transportables will decline from 260,000 units and \$442 million in 1983 to 150,000 units and \$225 million by 1987.

At press time, Osborne was still attempting a comeback. Adam Osborne and Jaunich retain their positions. Financial officer Waite says Osborne has received permis-

sion from the bankruptcy court to obtain \$600,000 in loans to buy the company more time to make agreements with its creditors and try to find financiers. "We know we've got a difficult row to hoe, but the people here are very upbeat," he comments.

—Tom Moran

DEC faces fierce competition during critical transition

Digital Equipment Corp., the \$4.3 billion leader in minicomputers and second-largest computer maker in the world, until 1981 stated its strongest asset boldly on a fleet of company vans: "We change the way the world thinks." For the first 24 years of its history, DEC's products virtually sold themselves on superior technology and strong software. DEC reigned king in laboratory applications and in most major markets it entered—terminals, superminicomputers and board-level microcomputers.

The company's luck has changed. The signal that DEC must change to win big in new markets and stay on top in old ones came in mid-1982 when, probably for the first time, DEC failed to lead in a major new growth market—personal computers. In this market, DEC found that having reliable products is not enough.

Being late with personal computers lacking software didn't help. Attempting to turn on a dime to address this new market, DEC stumbled along over the past year, unsuccessful at gleaming a major market share with its personal computers. Meanwhile, IBM Corp. moved aggressively to command a leading share of that market with about 400,000 hard disk- and floppy disk-based systems expected to

have been shipped by year-end, Future Computing Inc. studies show.

DEC says it shipped 50,000 personal computers in the first six months of manufacturing and hopes to ship 100,000 by year-end. Internal DEC figures show the company estimates the market for small business systems, including its personal computers, VAX and Micro PDP-11 lines—for businesses with less than \$100 million in annual sales—at \$6.2 billion and growing

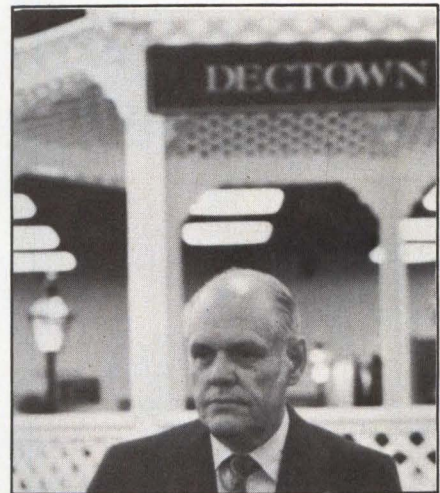

All eyes focused on DEC president Ken Olsen as he faced tough questioning during press day at DECTown, the company's exhibit for its sales staff and customers.

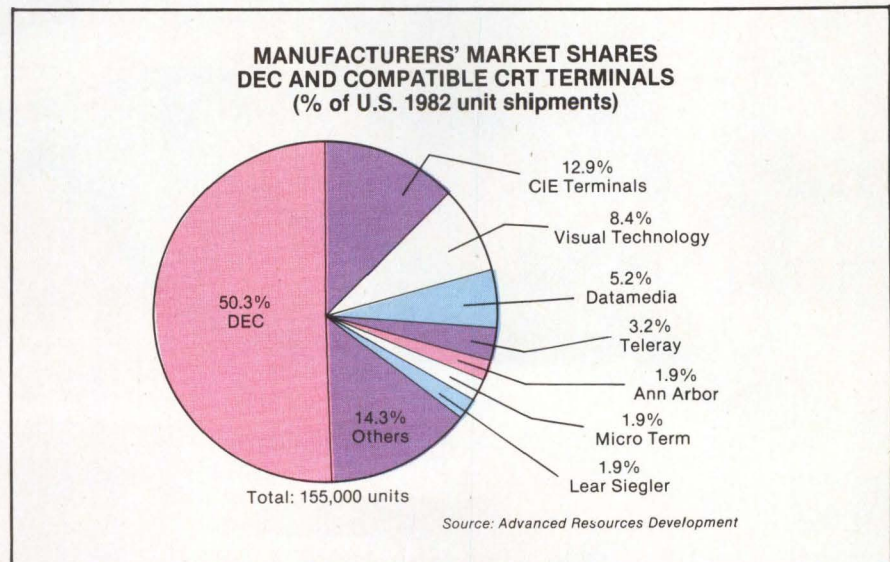

DEC plans to update its VT100 line with the VT200 series, which has more features and includes graphics and color models. DEC has a handsome installed base to work from with the forthcoming terminals. In 1982, unit shipments of 155,000 were worth \$220 million. Nearly one-half of those were from emulator suppliers, whose combined effect is slowly eroding DEC's market share, according to Advanced Resources Development.

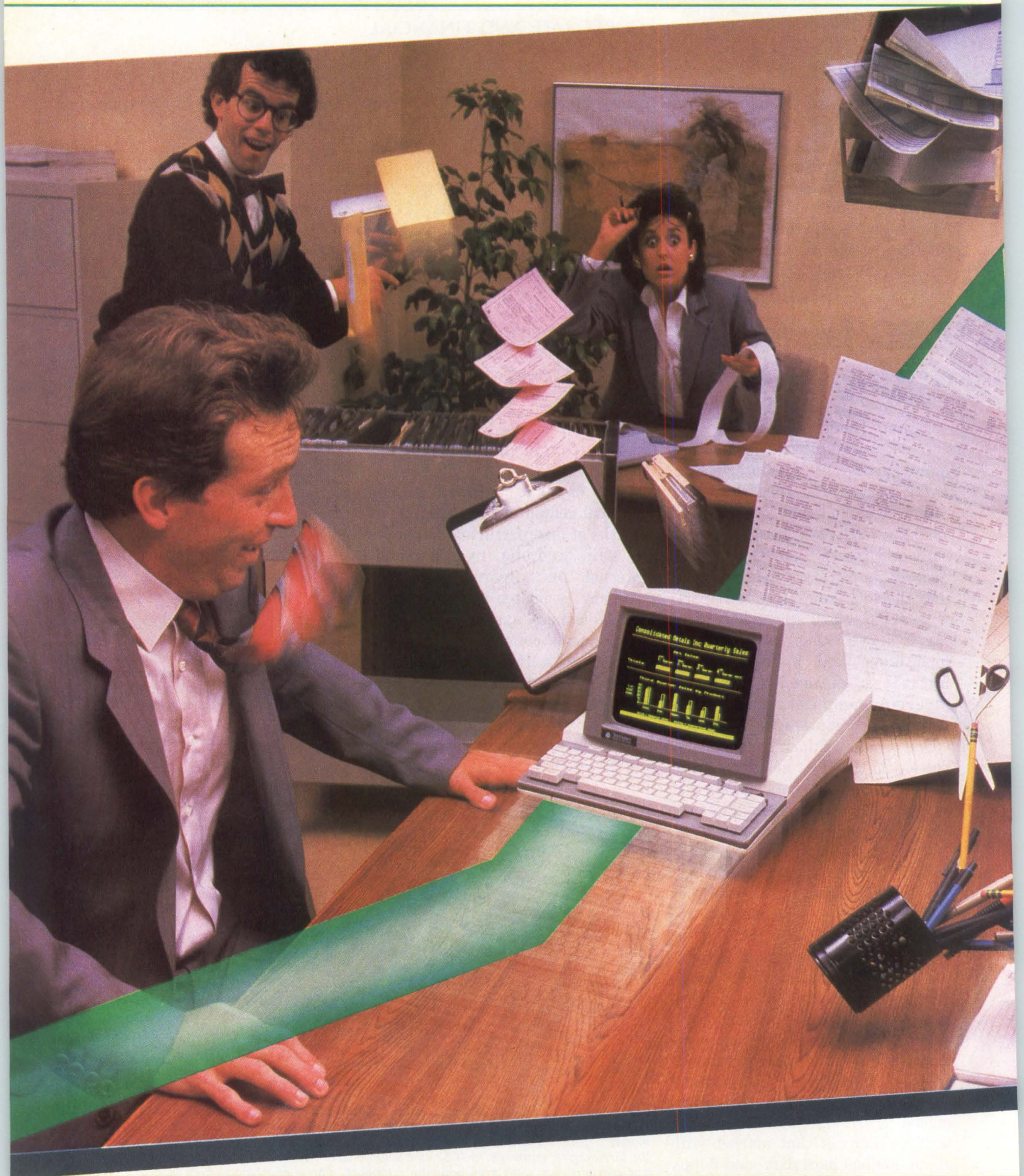

SEE US AT COMDEX,
BOOTH 1720 (EAST HALL).

CLEAR YOUR DESKS FOR THE PERSONAL TERMINAL BOOM.

Introducing a desktop revolution. The Personal Terminal from TeleVideo®—a compact new terminal for people who've forgotten what the finish on their desktops looks like. It isn't intimidating. It doesn't require programming knowledge. And it costs much less than a full-sized terminal. Clearly, the Personal Terminal will simplify the way your company works.

Want communications capabilities? Two RS-232 communication ports are standard equipment. An attached telephone option is available. And two optional, internal modems (300 or 300/1200 baud) put managers on-line with data services in seconds.

Want to expedite data retrieval? The Personal Terminal has 7 function keys (shiftable to 14) that reduce often-used commands to one key stroke. With a modem installed, those same keys can autodial up to 10 phone numbers. The built-in directory feature lets you autodial up to 18 more.

Send and receive electronic mail. Check inventory. Review sales and traffic figures instantly with the Personal Terminal. The 9-inch screen is easy to read. The professional keyboard is easy to use.

The Personal Terminal from TeleVideo. The desktop connection to a more intelligent, productive and cost-effective office environment. Isn't it time you got in on the information management boom?

Call us at 800-538-8725 for more information (in California call 408-745-7760) or contact your nearest TeleVideo office:

California/Santa Ana (714) 557-6095
California/Sunnyvale (408) 745-7760
Georgia/Atlanta (404) 399-6464
Illinois/Chicago Area (312) 351-9350
Massachusetts/Boston (617) 668-6891
New York/New Jersey (201) 267-8805
Texas/Dallas (214) 980-9978
France/Paris 33-1-687-3340
United Kingdom/
Woking, Surrey 44-9905-6464

GET IN ON THE BOOM.™



TeleVideo® Terminals

 TeleVideo Systems, Inc.

CIRCLE NO. 38 ON INQUIRY CARD

CRYSTAL UNIFORMITY
ADVANCED BINDER
REFINED LUBRICANT
IMPROVED JACKET
INTENSIFIED CALENDERING

THE GOLD STANDARD

**You can wait for industry standards
to mandate improved performance.
Or you can have it now on Maxell.
The Gold Standard.**

What distinguishes a Maxell floppy disk? Improvements great and small, achieved in a decade of innovation. We developed unique, uniform crystals to assure dense oxide packing. Intensified the calendaring process to minimize the need for abrasive burnishing. Created an improved binder and lubricant. And a new jacket design that leaves industry standards in our wake.

It would require photomicrographs to make some of these improvements observable. On the job, the advantages become obvious. Resolution enhanced by 20% creates a cleaner

signal output. And guarantees the read/write accuracy in double-density applications. New jacket construction, heat-resistant to 140°F, extends disk use without risk of mistracking. In effect, durability is redefined. And in accelerated tests against the most respected names in the industry, Maxell sustained the highest and most consistent output over time.

We applaud industry standards that aspire to dropout-free, reliable disk performance. The Gold Standard expresses a higher aim: perfection.



maxell
IT'S WORTH IT.

Computer Products Division, Maxell Corporation of America, 60 Oxford Drive, Moonachie, N.J. 07074 201-440-8020

CIRCLE NO. 39 ON INQUIRY CARD

Mini-Micro World

CORPORATE AND FINANCIAL

25 to 30 percent annually.

While bidding in the competitive personal computer market for the first time and possibly encountering IBM's might head-on also for the first time, DEC endured other major changes. Its breadwinning industrial markets bowed to recession, and long-term capital equipment projects that previously could tide DEC over poor economies vanished, resulting in worse bottom-line results. New markets meant heavier money commitments to R&D. New technologies and competitors eroded DEC's prices for the first time. A series of key executives and managers quit, beginning with Stan Olsen, brother of DEC president Ken Olsen. About a dozen resignations followed, culminating with the resignations of C. Gordon Bell, the chief technologist, who left to join Encore Computer Corp., a new enterprise formed by ex-Prime Computer Inc. president Kenneth Fisher, and, in early September,

Andrew C. Knowles III, the chief marketer (Knowles is credited by insiders with being the catalyst behind the PDP-11 VAX, VT100, semiconductor and other major markets DEC entered). Many of these people joined start-ups, some saying DEC's internal entrepreneurial environment diminished. The company also reorganized several times to better address new markets. The near decade of 30 percent or higher yearly growth ended as DEC posted a 1983 earnings dive of 32 percent.

Compounding the major market, organizational and cultural changes at DEC is the company's lateness with follow-on products for nearly all its major lines.

But the Maynard, Mass., giant appears to be laying the groundwork for a strong rebuttal in 1984. In late August, the company rented the 60,000-square-foot Hynes Auditorium in Boston to stage a one-and-one-half-week gathering of



The forthcoming VT200 family includes the VT240, which has the functions of a VT100 terminal, plus a printer port, advanced video, 15 programmable function keys, monochrome graphics and ReGIS and Tektronix 4010/4014 protocols.

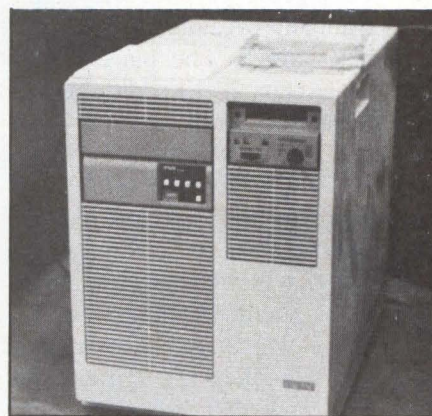

DEC's VAX-11/725 is positioned as a standalone system that is about 40 percent smaller than the 11/730.

DEC'S TOTAL OPERATING REVENUES
QUARTER BY QUARTER

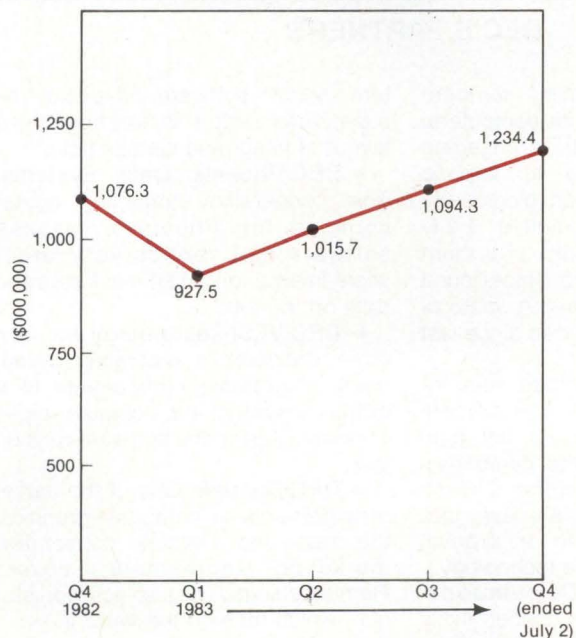

DEC'S NET INCOME
QUARTER BY QUARTER

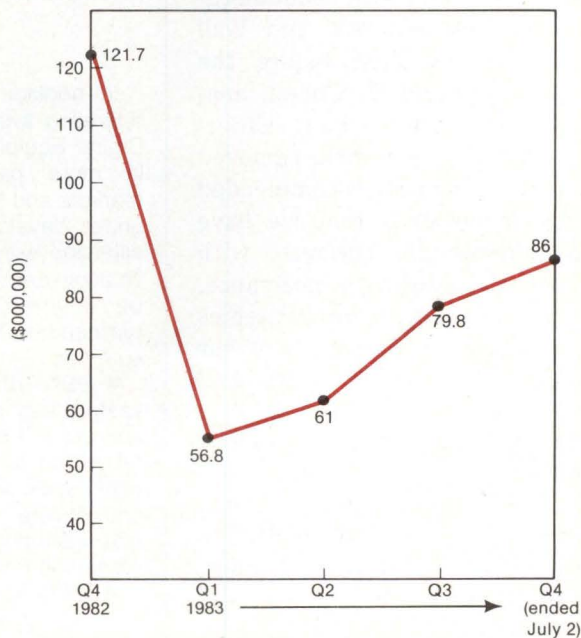

Mini-Micro World

CORPORATE AND FINANCIAL

its worldwide sales force. About 7,000 salespeople showed up, as well as families of DEC employees and preferred customers. DECTown was an exhibition of DEC equipment for DEC employees and customers, a show of the company's current and future strategies in mimic office, hospital, educational and other application settings.

"This DECTown extravaganza is to tell [our] goals to the salesmen," says company president Olsen. "All strategies are in one place." In a one-day session at the show, DEC let Wall Street analysts and the press go on an Easter egg hunt throughout the exhibit floor; about 10 new products stood among old-timers in the booths. These included the low-end VAX-11/725, which is about 40 percent smaller than the VAX-11/730, three VT200 series terminals, intended to replace the aging VT100 line, two new disk drives, a hard disk version of the Rainbow called the 100 Plus, the Rainbow 100 with more memory.

The hoopla, which took place after nearly a year's "quiet" period at DEC, helped smooth communication gaps between DEC and Wall Street analysts. Just before the meeting, Frederic H. Cohen, analyst for L.F. Rothschild, Unterberg, Towbin, New York, removed DEC's stock from his recommended list. "The upshot is that we have grown increasingly frustrated with the current operating performance, unclear about long-term strategies and hence less confident about our estimates for fiscal 1984 and beyond," he states.

Despite DEC's uncharacteristic openness at DECTown, many analysts still voice concern about whether DEC is out of the thick of its financial and product dilemmas. "There was no immediate news [at DECTown] to suggest that the severe margin pressures would abate near

term," reports Shearson/American Express analyst Donald Brown. "New products falling into place through next summer suggest the potential for a strong 1985 fiscal year."

It's clear from DECTown and Olsen's comments during the event that DEC's strategies hinge on very-large-scale-integration (VLSI) technologies in the product lines, personal computers and interconnecting different system products.

Olsen acknowledges DEC doesn't dominate the personal computer market but says the company is not giving up. "Every time we introduced a product, it appeared we were the last ones," he says. "For example, 16-bit computers. We waited and did it right," he claims. "We'll tolerate all the criticism until we come out with something really good," he emphasizes. Olsen believes the personal computers picked by OEMs will be of the highest industrial quality, and that's his goal for DEC's personal computers.

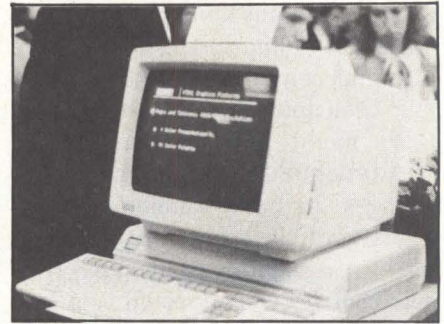

The VT241 color terminal does not have the profile of the Rainbow microcomputer but does include RGB output to drive a color projection system.

Some analysts have criticized DEC's not differentiating between its terminal and personal computer lines. The Rainbow, for example, was an outgrowth of the VT100 terminal line. The analysts hint DEC should spin off personal computers into a separate division. "We may separate personal computers into a division for organization," acknowledges Olsen. "But I do see terminals and personal computers together. It's never clear which does the job." He will not split the sales force or go to commissioned sales.

DEC'S PARTNERS

In addition to adopting standard operating systems for its computers, Digital Equipment Corp. is engaging in more partnerships to expand markets and bring in technologies not under development in-house. Early alliances with Rolm Corp., Northern Telecom and Xerox Corp. embellished DEC's networking options. A spate of partnerships have occurred since last summer:

- **DEC/Trilogy Ltd.** DEC has invested \$26 million for a 9 percent interest in Trilogy. In return, DEC gets an option to license the company's wafer scale semiconductor and possibly devote part of a new DEC manufacturing plant to a product stemming from Trilogy's technology.

- **DEC/Scientific Calculations.** Both companies will cooperatively market Micro-Electronics Design Sys-

tem (MEDS) software on DEC's VAX superminis. MEDS is for automated layout of integrated circuits (ICs).

- **DEC/Phoenix Data Systems.** This cooperative marketing agreement is for Phoenix's MASKAP software that verifies very-large-scale-integration (VLSI) mask sets and runs on the VAX.

- **DEC/VLSI Technology Inc.** Another cooperative marketing agreement to promote components of a graphics system for computer-aided IC design. Again, the software runs on VAX.

- **DEC/Ramtek.** One of the earlier arrangements in computer graphics, the DEC and Ramtek cooperative marketing agreement covers Ramtek's MARQUIS graphics workstation, which runs on the VAX.

DYNASTY

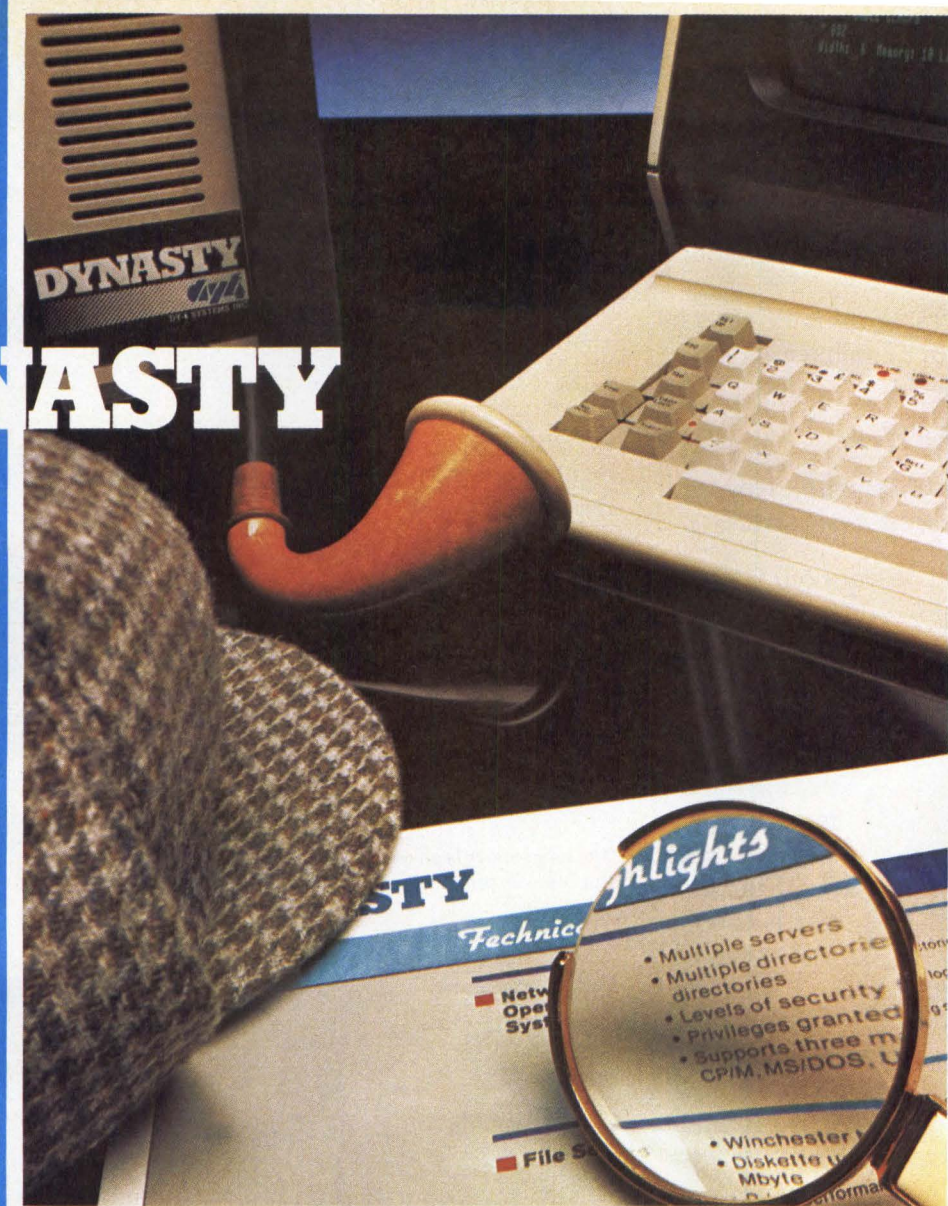

Investigate the alternative computer system

Take a good, close look at Dynasty. If you're a systems integrator, OEM, ISO or end user, it's well worth it.

Dynasty is a distributed micro-computer system based on a local area network.

It's the logical and cost effective alternative to:

- stand-alone personal computers
- multi-user systems
- timesharing systems

Dynasty can be as little as half the cost of its alternatives. And it's got so much more.

- Dynasty supports the three major operating systems: CP/M, MS-DOS, and UNIX.
- As many as 64 workstations can be connected to the 4,000 feet of network cable. And those workstations can be either 8 or 16/32 bit.

• You can use Dynasty's own high performance workstations or other popular microcomputers like the IBM PC.

• Dynasty is the ideal alternative system for the office, industrial plant, college or university. And it's ideally priced.

Investigate the many benefits of Dynasty. It's well worth it.



Dy-4 Systems Inc.
1475 South Bascom Avenue
Suite 202
Campbell, CA 95008
(408) 377-9822

888 Lady Ellen Place
Ottawa, Ontario, Canada
K1Z 5M1
(613) 728-3711
TLK : 053-4969

CIRCLE NO. 40 ON INQUIRY CARD

See us at COMDEX, Las Vegas

Attach your business card to this coupon and we'll send you detailed information on Dynasty, the alternative computer system.

Dy-4 Systems Inc.
1475 South Bascom Avenue
Suite 202
Campbell, CA 95008

MB

“We’ll ship thousands of we build our reputation

Reputation...It’s the most valuable asset a disk drive manufacturer can have.

Here’s what it means for you:

- **Availability** • **Price**
- **Reliability** • **Customer support and assistance**

And now that we’ve built our reputation, we’re protecting it—one drive at a time.

Uninterrupted Component Supply

Our team of sister companies provides a dedicated, uninterrupted supply of quality Winchester heads and plated media.



They’re the heart of a

quality disk drive assembly. By working toward a common goal with them, we’re able to ensure that we receive the highest quality of components possible for the drives we manufacture.

8-inch Drives

For very large storage applications, nothing can match our DP-100 and 400 as well as the D-1100 and 1600 lines of fixed and removable Winchesters.

For fast, accurate system back-up, our 8-inch removable units are the best solution available.

We’ll stack our DP-100 drives up against cartridge and streaming tape any time.

We’ll prove you can have excellent read/write accuracy and reliability without the need for field adjustments.

Check for yourself.

5¼-inch Drives

Seven different models to choose from. Tailor the drive capacity exactly to your system needs—without a lot of added waste or expense.

Unformatted capacities from 6.38 to 62.7 Mb.

Every one helps insure your system continues to perform at its best.

	5.25"							8"
	D-507	D-514	D-519	D-526	D-720	D-740	D-760	DP-100
Capacity								
Unformatted								
Per drive (MBytes)	6.38	12.75	19.13	25.5	26.9	44.9	62.7	11.6
Per surface (MBytes)	3.18	3.18	3.18	3.18	8.95	8.95	8.95	5.8
Per track (Bytes)	10,417	10,417	10,417	10,417	10,416	10,416	10,416	13,440
Formatted								
Per drive (MBytes)	5.01	10.02	15.04	20.04	21.1	35.2	49.3	10.6
Per surface (MBytes)	2.51	2.51	2.51	2.51	7.045	7.045	7.045	5.3
Access time								
Average (msec)	80	80	80	80	35	35	35	60
Maximum (msec)	230	230	230	230	85	85	85	110
Discs								
Recording surfaces	2	4	6	8	3	5	7	2

The chart above is an overview of the Disatron product line.

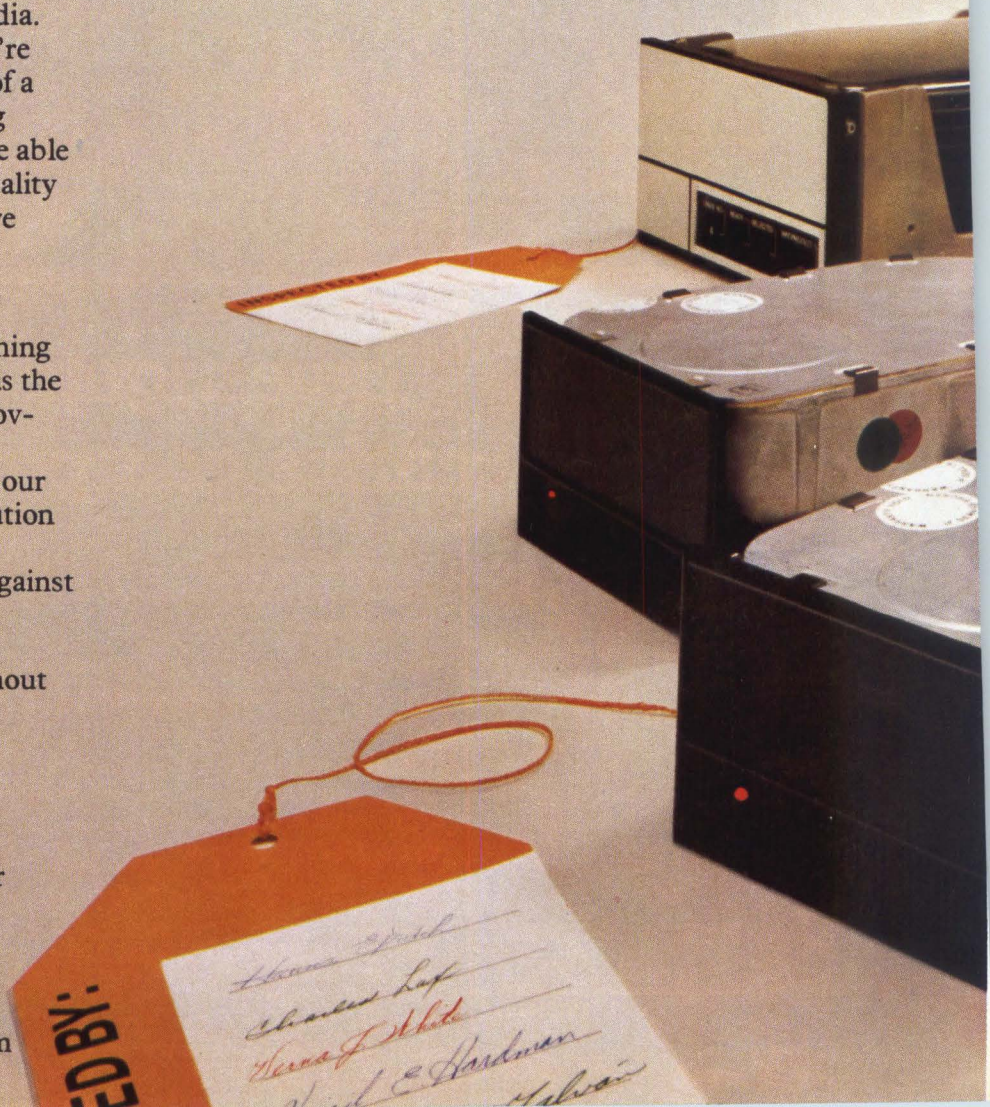

drives this month but... one drive at a time."

8"

DP-400 D-1100 D-1600

46.4 121.9 157.5

11.6 17.4 22.9

13,440 13,440 20,160

42.4 111.5 SMD

10.6 15.9 20.9

60 35 30

150 60 60

3 4 4

4 7 7

People to People

Whether you're a young company planning to be big or a big company planning on being even bigger, we'll work with you as though you're our only customer.

That means personal attention to your requirements and flexibility in accommodating those needs.

Disctron has the quantity and quality of Winchester drives you need. All at a price that is highly competitive.

We've built our reputation one drive at a time—because your reputation depends on it.

Call or write us today. Disctron, Inc.,
1701 McCarthy Blvd., Milpitas, California
95035, (408) 946-6692, TWX: 910 338 2068.

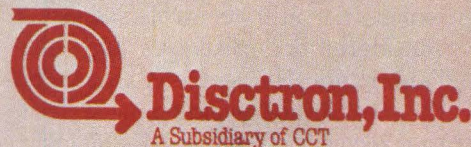

See us at Comdex Booth #H7308.

CIRCLE NO. 41 ON INQUIRY CARD

©Copyright Disctron, Inc. 1983



William L. Morgan
William L. Morgan
President

Mini-Micro World

CORPORATE AND FINANCIAL

The sales force at DEC, after the series of reorganizations, has come under the control of John Shields, vice president of field operations. Shields came from field service, which he still controls, and is considered one of Olsen's two chief lieutenants. He represents perhaps the most dramatic personnel shift at DEC recently. Insiders say Shields is very aggressive. He built the field-service operations strongly and developed loyalty among his troops. Despite analysts questioning why a field-service person would control sales, Olsen believes Shields' background in field service is a strong asset. "He sets responsibility clearly to measure people," notes Olsen. "Job allocations and measurements are very important in sales," he adds.

Additional changes from the reorganization include consolidating operations of the 12 U.S. "entrepre-

neurial" product groups into three regional management centers, leaving the product groups with only marketing duties. Formerly, product line managers were responsible for marketing and parceling out annual budgets to manufacturing and sales for the future six quarters. Marketing is a weakness analysts say DEC must correct,

especially with the company's focus on major accounts sales encompassing all product lines. "I also criticize the marketing of the company," says Olsen. "We try so hard to present products in a technical, honest way. Sometimes, we're tedious in our approach. We still have a way to go," he admits.

—Lori Valigra

DIGITAL EQUIPMENT CORP. 12-YEAR FINANCIAL SUMMARY

	Equipment sales revenues (\$ millions)	Service and other revenues (\$ millions)	Total operating revenues (\$ millions)	Net income (\$ millions)	Net income per share (\$)
1983	2,867.4	1,404.4	4,271.6	283.6	5.00
1982	2,793.7	1,087.1	3,880.8	417.2	7.53
1981	2,384.2	813.9	3,198.1	343.3	6.70
1980	1,779.4	588.6	2,368	249.9	5.45
1979	1,381.8	422.3	1,804.1	178.4	4.10
1978	1,128.1	308.5	1,436.6	142.2	3.40
1977	847.5	211.1	1,058.6	108.5	2.78
1976	586.6	149.6	736.3	73.4	1.98
1975	433.2	100.6	533.8	46	1.28
1974	360.8	61.1	421.9	44.4	1.27
1973	229.1	36.4	265.5	23.5	.72
1972	166.3	21.3	187.6	15.3	.50

Source: Digital Equipment Corp.

FORTHCOMING PRODUCTS AND RECENT ANNOUNCEMENTS FROM DEC—AT A GLANCE

- VT200 series: VT200, VT240, VT241 (expected by year-end)
- VT220: VT100 functionality, printer port, advanced video, 15 programmable function keys, advanced ease-of-use features
- VT240: VT220 functionality plus monochrome graphics, REGIS protocol, Tektronix 4010/4014 protocol, optional integrated modem
- VT241: VT240 functionality plus color and RGB output to drive a color projection system. Has nine- or 25-pin EIA or 20-MA current-loop interfaces
- The products include a new keyboard. They will replace the VT100 series products, although DEC will continue supporting VT100s
- RD series 10M-byte, 5¼-inch Winchester disk drives: RD51A, RCD51-AA/AE, RCD51-CA
- RD51A: for Micro PDP-11, announced May 1983, available now
- RCD51-AA/AE: for Pro 350;

- storage subsystem with disk drive, announced June 1983, available now
- RCD51-CA: for DECMate II; storage subsystem with disk drive, controller, diagnostic software, announced August 1983, available second quarter, 1984
- DECTalk "talking" typewriter
- VAX series
- VAX-11/725 VMS compatible, repackaged 11/730 that's about 40 percent smaller, closed system regarding add-ons, 26M bytes fixed/26M bytes removable Winchester disk storage, 3M bytes maximum memory, Ethernet
- DEC president Ken Olsen alluded to five VAXs to be released over the next two years: Micro VAX/1, due in October, a VAX with a floating-point processor, a larger VAX and two high-end VAXs
- Personal computers
- Professional 350 upgrade: doubled main memory to 512K

- bytes, added floating-point functions as standard, added a 10M-byte hard disk drive, improved performance 25 percent (announced)
- Rainbow: MS-DOS support added, price cut of 40 percent for the Rainbow's 192K-byte RAM option. More than 700 application packages are available (announced)
- Tool Kit available for third-party software developers for the Professional 350 (announced)
- Rainbow new 100 and 100 Plus: new 100 comes with double the main memory, or 128K bytes, and is expandable to 896K bytes rather than 256K bytes on the earlier model. The power supply is larger, mainly to accommodate the 10M-byte Winchester disk for the Rainbow 100 Plus (expected in late September)
- Higher performance office-automation product expected next year.

LEADER OF THE PACK



The Quality Leader:

BASF disk packs and cartridges reflect BASF technology and quality, because unlike many suppliers, we make them ourselves.

BASF drive tests each pack at the factory to ensure optimum performance.

BASF commitment to magnetic media is now in its 50th year.



The Performance Leader:

BASF mirror-polishes its uncoated disks for optimum headflight characteristics.

BASF magnetically orients all oxide particles in the disk coating for greater packing density.

BASF coats, polishes, and burnishes each disk by its own process, for long-lasting, trouble-free operation.



The Value Leader:

BASF has the configuration you need... for Burroughs, CDC, Data General, DEC, Honeywell, IBM, NCR, Wang... ready for immediate delivery at new low prices.



The Premium Leader:

BASF has a new premium program with exciting gifts to add extra value to your order.

For ordering or compatibility details, send the coupon today, or call toll-free 800-343-4600.



*For Burroughs: Front-load single disk cartridges, 80 MB Tridents
 For CDC: 80 and 300 MB storage modules, Phoenix single disk cartridges.
 For Data General: 50, 100, 200, and 300 MB disk packs, top-load single disk cartridges.
 For DEC: 100 and 200 MB 12-high packs, front-load single disk cartridges, 80 and 300 MB storage modules.
 For Honeywell: Phoenix single disk cartridges, 80 and 300 MB storage modules, 100 MB packs.
 For IBM: 100 and 200 MB 12-high packs, top and front-load single disk cartridges.
 For Wang: Phoenix single disk cartridges, 80 and 300 MB storage modules, top-load single disk cartridges.



BASF

BASF Systems Corporation
 Attn.: Marketing Services, Computer Division
 Crosby Drive, Bedford, MA 01730

Please send me information on BASF Disk Packs, your new low prices, and premium program.

Name/Title _____

Company _____

Address _____

City _____ State _____ Zip _____

Telephone _____

MMS

Mini-Micro World

CORPORATE AND FINANCIAL

Financings

Atasi Corp., San Jose, Calif., grabbed \$21 million in its second round of venture-capital financing. Investors include Citicorp Investment Management and General Electric Pension Trust.

Businessland Inc., San Jose, Calif., has arranged a \$25 million line of credit with the Bank of America to facilitate Businessland's plans for nationwide expansion. Businessland has 13 retail computer stores in the San Francisco Bay area, Southern California, Arizona and Texas.

Wet ink

In a contract valued at \$3 million, **Drivetec Inc.**, San Jose, Calif., has committed to supply its 3.3M-byte, 5¼-inch, half-height SuperMini-floppy disk drives to Rana Systems, Chatsworth, Calif. The contract's duration is 18 months....**Kennedy Co.**, Monrovia, Calif., has signed a \$1 million contract with Great Western Computers, Rancho Cucamonga, Calif. The contract covers Kennedy 8- and 14-inch Winchester disk drives and a nine-track magnetic-tape transporter....**MAI Canada Ltd.**, a subsidiary of Management Assistance Inc., New York, will provide Basic Four Information Systems Division microcomputer and minicomputer systems and support to the Century 21 real estate franchise network in Canada. The contract covers at least 150 Century 21 offices and is valued at \$1.5 million to \$4 million....**Mouse Systems Corp.**, Santa Clara, Calif., will supply mice to be used with VisiCorp's Visism decision-support software for microcomputers. The Mouse Systems device is an optical mouse that tracks motion by counting lines. More typical mechanical mice sense motion by the use of a metal ball underneath

the mouse. List price of the mouse is \$249....In a four-year, \$20 million contract, **Paradyne Corp.** will supply 12,000 modems and multiple network-analysis controllers to J.C. Penney Co. Inc....The U.S. Army Communications and Electronics Command (CECOM), has awarded **SofTech Microsystems Inc.**, Waltham, Mass., a \$3.8 million contract to provide maintenance for the Ada Language System.

Industry monitor

MicroPro International Corp., producer of the WordStar word-processing package for microcomputers, has hired former Sperry Corp. executive **H. Glen Haney** as president and chief executive officer "to direct the company in rapid but



H. Glen Haney, former Sperry Corp. executive, has been hired by MicroPro International Corp. as president and chief executive officer. He is expected to lead the company in "rapid but controlled growth."

controlled growth." Haney was vice president of business strategy and new markets for the Sperry Computer Systems division.

BOX SCORE OF EARNINGS

This monthly table lists the revenues, net earnings and earnings per share in the periods indicated for companies in the computer and computer-related industries. Parentheses denote losses. Comments are from corporate summaries unless otherwise noted.

Company	Period	Revenues	Earnings	Eps
Altos Computer Systems	year 6/25/83	\$74,587,000	\$7,921,000	.58
	year 6/26/82	\$50,957,000	5,708,000	.50
Avant-Garde Computing Inc.	3 mos. 7/31/83	3,033,000	199,000	.07
	3 mos. 7/31/82	1,338,000	85,000	.03
Centronics Data Computer Corp.	6 mos. 7/3/83	88,368,000	641,000	.06
	6 mos. 6/27/82	55,994,000	(13,686,000)	(2.19)
Gipher Data Products Inc.	year 6/30/83	76,429,000	5,161,000	.50
	year 6/30/82	55,124,000	2,236,000	.30
Cullinet Software	3 mos. 7/31/83	25,798,000	3,641,000	.24
	3 mos. 7/31/82	16,137,000	2,373,000	.17
Datapoint Corp.	year 7/31/83	540,192,000	8,077,000	.40
	year 7/31/82	508,486,000	2,405,000	.12
Masstor Systems Corp.	6 mos. 7/3/83	10,836,000	(1,689,000)	(.18)
	6 mos. 7/4/82	9,011,000	528,000	.06
Rexon Inc.	9 mos. 7/3/83	10,136,000	(66,000)	(.03)
	9 mos. 7/4/82	7,789,000	(241,000)	(.14)
Tandy Corp.	year 6/30/83	2,513,297,000	278,521,000	2.67
	year 6/30/82	2,061,212,000	224,085,000	2.17

Comments: Centronics Data Computer Corp. revenues for the second quarter grew to \$44.6 million from \$29.7 million in the same period a year earlier. The company showed a net income of \$357,000, or 4 cents per share as opposed to a loss of \$3.1 million, or \$1.86 per share, a year earlier. Centronics said it reduced inventories (by \$4 million), bank borrowings (by \$8.5 million) and expenses during the quarter.

Datapoint Corp. said its domestic markets for office and computer products were up strongly in the fourth quarter, but international orders remained sluggish. Datapoint's fourth-quarter revenues were \$137.5 million, compared to \$140.8 million a year earlier. Net earnings were up to \$4.3 million, or 21 cents per share from \$3.3 million, or 16 cents per share in the fourth quarter of fiscal year 1982.

DEC-COMPATIBLE SEMI ADD-INS

NEW!

1.0 MB
VAX 730

1.0 MB
VAX 750

2.0 MB
VAX 780

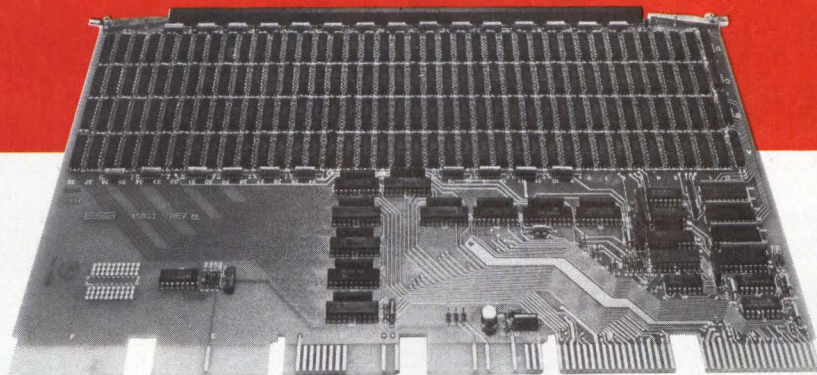

FROM THE LEADER

Look to the leader — Dataram — for your DEC-compatible semiconductor ADD-IN memory. Offering not only the broadest, most complete line of semi ADD-INS, but the most capable...no matter what your yardstick. Compatibility, throughput, cost, power efficiency, size...no matter how you measure capability, Dataram DEC-compatible semi ADD-INS are the clear leader.

A leadership position earned by improving on DEC's price and delivery...and then adding features available from no one else in the industry.

The chart provides a glimpse at the industry-pacesetter family of DEC-compatible semi ADD-INS. Call us today at (609) 799-0071, and we'll give you a close-up look at the products that have made us the leader.

**DATARAM
CORPORATION**

Princeton Road
Cranbury, New Jersey 08512
Tel: 609-799-0071 TWX: 510-685-2542

DEC Mini	Dataram ADD-IN	Board Size	Maximum Capacity
LSI-11®	DR-115S	dual	64 KB
LSI-11	DR-215	dual	256 KB
LSI-11	DR-213	quad	1.0 MB
PDP®-11	DR-114S	hex	256 KB
PDP-11	DR-114SP	hex	256 KB
PDP-11	DR-214	hex	1.0 MB
PDP-11	DR-144	hex	256 KB
PDP-11	DR-244	hex	1.0 MB
VAX®-11/750	DR-175	hex	256 KB
PDP-11/70			
VAX-11/750	DR-275	hex	1.0 MB
VAX-11/730			
VAX-11/780	DR-178	extended hex	512 KB
VAX-11/780	DR-278	extended hex	2.0 MB
DECSYSTEM 2020®	DR-120	extended hex	256 KB

DEC, DECSYSTEM 2020, PDP and VAX are registered trademarks of Digital Equipment Corporation.

Dataram also provides core ADD-INS, core and semiconductor ADD-ONS, memory system units, memory management, and a wide range of memory-related accessories for DEC users.

THE CORONA PC'S™ ARE HERE.

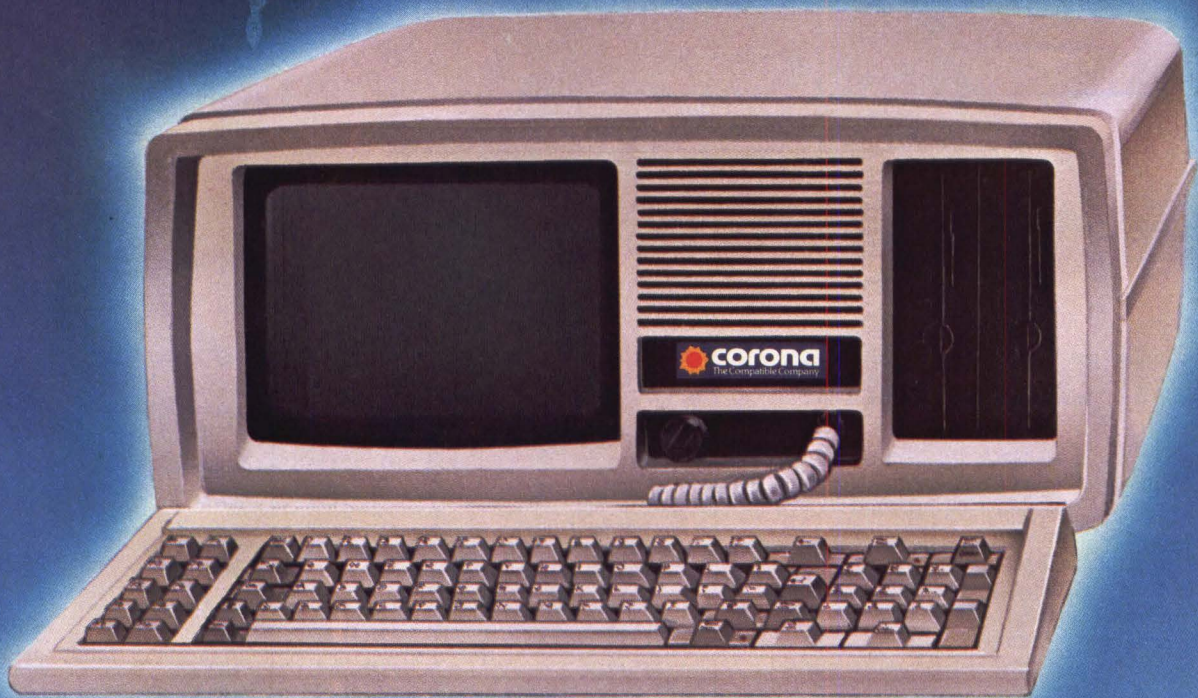

The Corona PC's, desktop and portable, give you everything you've ever wanted in an IBM-compatible PC and more. For a great deal less.

Compatible and more.

The Corona PC is a 16-bit microcomputer based on the 8088 microprocessor, just like the IBM PC. And like the IBM PC, it runs any software that conforms to the IBM standard.

But unlike the IBM PC, the Corona PC comes with 128K of memory. Supports up to 512K on the main board. Includes a 320K floppy drive, a communication port, a printer port and an improved IBM PC keyboard.

Both the desktop and portable Corona PC's include high-resolution monitors and built-in graphics. Higher character definition makes both models easier to read, and our 640 x 325 pixel high-resolution graphics are over 60% better than the

IBM PC. It's a complete system, the standard for microcomputing in the IBM-compatible world.

You can take it with you.

And unlike IBM, we have a portable version.

Its high-resolution, high-contrast 9" display is easy to read. It has all the power and features of our desktop, but lets you take it to the office next door, across the country or just conveniently tuck it onto a corner of your desk.

More expandability.

You may never add a thing to your Corona PC because we've built in so much capability.

But just in case, we've built all the important components into the main system board, leaving the four expansion slots free. And provided an extra large power supply to support any capabilities you may want to add in the future.



RAM-disk for incredible speed.

Our RAM-disk software lets you treat an area of your computer's memory as if it were a disk drive. So you can copy your programs and data into memory, then watch your work get done faster.

More software.

The Corona PC includes the MS-DOS operating system and comes with GW-BASIC, the MultiMate¹ word processor and the PC Tutor² training course. So you can start being productive immediately.

And you can run Context MBA³, dBASE II⁴, LogiCalc⁵ and LogiQuest⁵, the EasyFamily⁶, Wordstar⁷ and the "Star" family, the SuperWare⁸ series, T.I.M.⁹, the VisiSeries¹⁰ and Perfect Series¹¹ of programs and most other popular software.

And it improves your bottom line.

The Corona Portable PC[®] is \$2,545, the desktop

version is \$2,595. Both about a thousand dollars less than the equivalent IBM PC.

For more information, contact Corona Data Systems, 31324 Via Colinas, Westlake Village, CA 91361. (213) 991-1144. Call (800) 621-6746 toll-free.

Or better yet, just grab your hat and head to the nearest Corona PC dealer for a very convincing demonstration.

See us at Comdex Booth #310.



corona
The Compatible Company

© Corona Data Systems 1983 1: TM Softword Systems. 2: TM Comprehensive Software Support. 3: TM Context Management Systems. 4: TM Ashton-Tate. 5: TM Software Products International. 6: TM Information Unlimited Software. 7: TM Micropro. 8: TM Sorcim Corp. 9: TM Innovative Software. 10: TM Visicorp. 11: TM Perfect Software Inc.

CIRCLE NO. 45 ON INQUIRY CARD

RIDE YOUR WAY TO SUCCESS ON A ZEBRA.™

Hitch your application software to a Zebra by GA and watch your sales take off.

The reason is Zebra's ability to outdistance the competition. The fact is, Zebra is faster and more powerful than any other multi-user microcomputer system in its class. Inside every Zebra beats the heart of the powerful Motorola MC68000® microprocessor. Allowing up to 64 different users to perform a variety of tasks including standard accounting, word processing, business graphics and financial spreadsheets. All simultaneously. And every Zebra can accommodate a wide range of industry-oriented applications as well.

Zebra appeals to virtually all customers because it's so friendly. Zebra utilizes the

**Test Ride a Zebra at
Comdex Booth H 7348.**

**To have a salesman call
immediately, circle 197.**



PICK™ Operating System. And with ACCESS™ the system's information management and retrieval language, Zebra speaks English. So training and instruction are minimal.

Zebra also runs the Microsoft XENIX™ Operating System opening up an infinite variety of applications for commercial, engineering and scientific tasks.

Another nice thing about Zebra is its modular growth. As your customer's business grows, Zebra grows with it.

Zebra follows in the tracks of over 30,000 satisfied users of GA computers worldwide. And like every reliable GA computer, Zebra keeps running year after year. Every Zebra is backed by MAI/SORBUS®, the number one rated service organization in the country. And our dealers are backed by GA's professional field sales and technical support organizations.

Zebra is off and running. With a national ad campaign, co-op plans, sales material and some of the most profitable margins in the industry. Call or write now for more information. GA, 1045 South East St., P.O. Box 4883, Anaheim, CA 92803 (714) 778-4800; Toll-free 1-800-556-1234, Ext. 41. In California, 1-800-441-2345, Ext. 41.

ZEBRA BY GA



For information only circle 196.

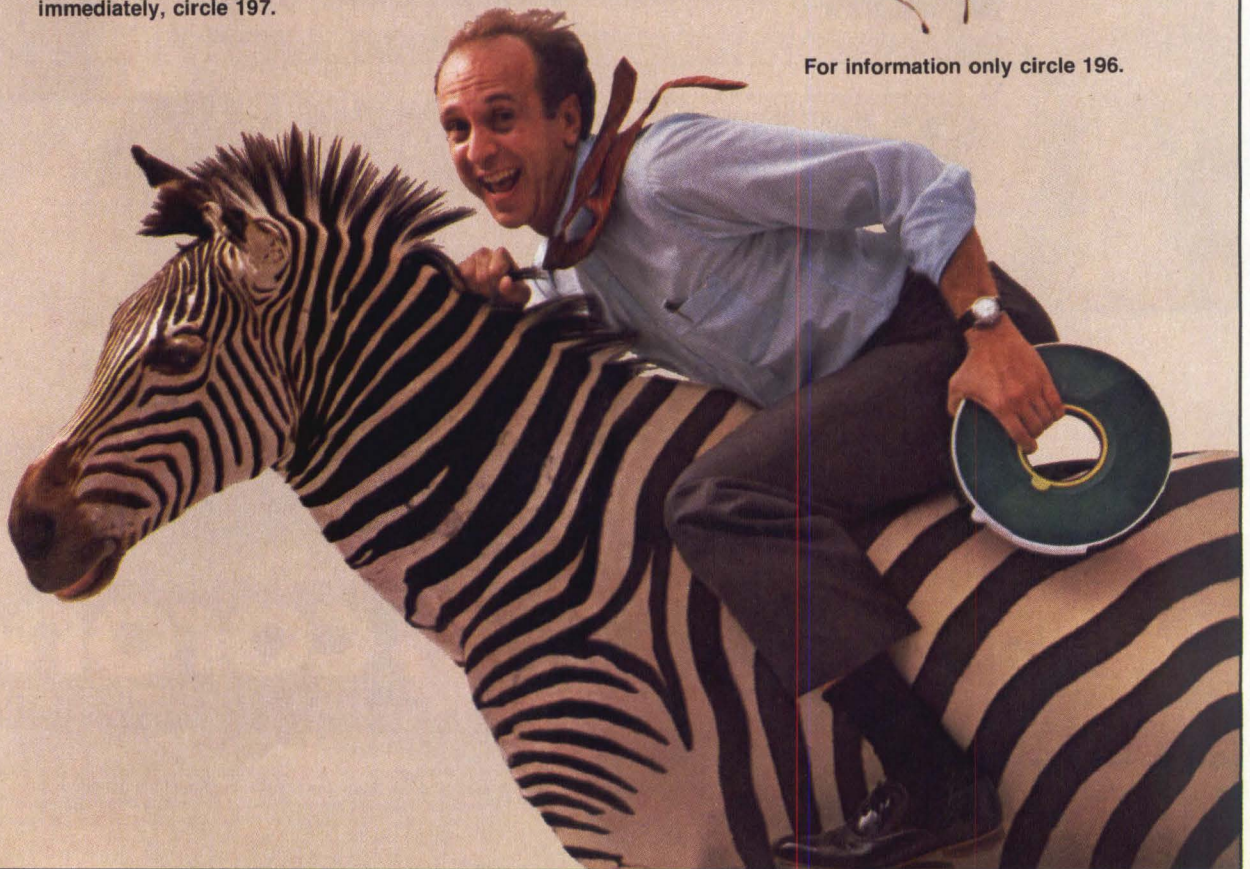

Mini-Micro World

INTERNATIONAL

Processor-independent STE bus standard expected from IEEE

By early next year, the P1000 working group of the IEEE's microprocessor standards committee may approve STE, a proposed 8-bit bus standard competing with the STD bus and said to offer complete microprocessor independence. STE, which will be conceptually like an 8-bit high-speed input-output channel, will use the Eurocard form factor, as does the IEEE 32-bit Futurebus and Motorola Inc.'s 16-bit VME bus. The STD specification, which may also soon be approved by the IEEE, is already widely used, particularly in Z80- and 8085-based control applications.

Bill Shields, chairman of the P1000 group and president of Seaport Computer Systems, a San Diego design consulting company, hopes that IEEE will publish STE early in 1984, following approval by the P1000. He explains that the most fundamental difference between STE and STD is that STE uses an asynchronous rather than synchronous data-transfer protocol. STE also allows direct addressing of 1M byte of main memory, compared to STD's maximum of 64K bytes. Like the Eurocard, the STE uses the Deutsches Institut für Normung (DIN) 41612 two-part edge connector. Another STE feature, aimed at

complete processor independence, is the assignment of exactly the same signals on every pin, regardless of the microprocessor attached to the bus. The STD specification calls for four unassigned pins.

Although no major computer manufacturers plan to use the STE bus, Shields insists many people are anxiously awaiting a Eurocard-based bus standard. They include other consulting companies, laboratories, government and military users and some small manufacturers of STD-based systems.

The STE's asynchronous protocol allows for speed differences between different boards, such as a high-speed microprocessor (master) board and a slower memory board on the bus, explains Tim Elsmore, European secretary of the P1000 group. Thus, microprocessor independence is further enhanced.

In the STD camp is Matt Biewer, chairman of the IEEE P961 group preparing a separate STD standard proposal and vice president of Pro-Log Corp., Monterey, Calif., a manufacturer of STD-based boards for control applications. He argues that STD's synchronous protocol provides a wait state for speed differences, although the delay may be longer because of the STD's fixed

length of the wait states' time intervals. Biewer also points to the added complexity of STE's asynchronous protocol, a fact that Elsmore acknowledges.

Shields notes that STE's direct addressing of 1M byte of main memory helps accommodate 16-bit microprocessors. Although Biewer admits STD is limited to 64K bytes unless memory-extension boards are used, he believes the problem is eliminated if the Intel 8088 is used. This is because the 8088 can multiplex 2 bytes. He also admits that using the MC68000 series chips, however, could present a problem.

Biewer admits STE could beat STD in the European market, where Eurocard is favored. He acknowledges that Europeans do not like the edge connectors of the STD bus, preferring instead the more expensive but more reliable DIN 41612 two-part connector.

Biewer acknowledges the four unassigned pins in the STD specification allow for the unique signals generated by peripheral control of some microprocessors. For example, he points out, Zilog Z80 peripheral cards generate signals incompatible with master boards without Z80 processors. As a result, a board manufacturer may have to specify compatibility with only a subset of STD such as STD Z80 or STD 8085 (for the Intel 8085).

Elsmore claims that STE users can directly swap a master board on an STE system with any other master without changing any other boards. However, this level of processor independence means incorporating signal-modification logic on STE boards, on which space is at

COMPARISON OF STD AND STE BUSES

	STD	STE
Data-transfer protocol	Synchronous	Asynchronous
Main memory addressing (bytes)	64K	1M
Connector	Edge	2 part
Pin signal assignment	4 unassigned pins	All pins assigned
Size (inches)	6.5 × 4.5	6.3 × 3.94

OVERHEAD OVERSEAS

By Maureen O'Gara
Contributing Editor, West Germany

Ericsson prepares major personal computer push

L.M. Ericsson, the multibillion-dollar Swedish telecommunications and computer company, is planning its first major assault on the personal computer market, using West Germany as a launchpad. The giant firm could muster the talent and resources to do a creditable job in its desire to grow in integrated office systems. If successful in Germany, Ericsson may expand to the rest of Europe and to the United States.

However, Ericsson is not a mainstream (United Kingdom, Germany, France) European company. The obstacles it must overcome to address the European market are similar to those faced by U.S. companies entering Europe.

Since Ericsson is not part of the European mainstream, it has no special hold on markets.

Ericsson has done some homework and decided personal computers are where it wants to be. It's also decided there are two markets worth fighting for: the United States and Germany. Ericsson thinks so much of America that it's transferring the president of its computer subsidiary, Ericsson Information Systems, Sweden, where he had worldwide responsibilities, to the United States, where he will handle only the stateside operation.

The other market in the major leagues is Germany. All the players are in Germany: American, German and other European companies are represented. It is the largest, most competitive, most performance-oriented and most technically sophisticated of the European markets, Ericsson believes. That's why it was chosen as Ericsson's testing ground. "If it can survive in Germany, it can survive anywhere in Europe," according to Ulrich Giesen, Ericsson Information Systems GmbH's dealer organization manager.

Ericsson's research indicates the German market is worth 100,000 machines a year, with 80 to 90 percent sold to small companies. The bigger companies, those with 1,500 employees or more, are buying the rest. Ericsson's forecasts indicate that when the market grows to 400,000 personal computers a year in 1986-1987, as many as two-thirds of the machines will be sold to big companies.

Giesen's studies show there is no market for personal computers among German businesses employing 50 to 1,500 people. That is minicomputer turf for the immediate future.

To Ericsson, the findings mean product differentiation. Personal computers have to be IBM-like to some degree, it knows, because IBM Corp. sets the pace. Big companies, however require more bells and whistles than do small buyers because they will use the PC as a terminal or workstation requiring mainframe communications, videotex implementation, teletext hookup, etc.

Ericsson, facing the problem so many others have, can't muster complete IBM compatibility right away. Last month, it introduced what it terms a "somewhat compatible" MS-DOS box called Step One that is priced 10 percent under the IBM PC. Coming up next year are additions to the family that will increase its compatibility. But it would be fool's play, Ericsson reasons, to take IBM on head to head.

Its future boxes will have to offer more bang for the buck than do IBM's. The additions planned for the second quarter of 1984 aren't priced yet. Both will be MS-DOS-based, one about IBM's equivalent, the other four times faster. All three units, though aimed at different market segments, will be sold through dealers.

Ericsson's research shows that all

but the top 10 dealers in the German personal computer business are losing their shirts.

Normally, Ericsson says, a German dealer isn't selling more than 20 boxes a year. But the dealers haven't established themselves in tight vertical markets. Based on long-standing tradition, they service the local community where they probably grew up and are known and respected. One month, they sell a system to the butcher, the next month to the baker, the next to the dentist and so on. With typical systems going for 15,000 Dmarks, the average dealer, Ericsson says, is making 60,000 to 80,000 Dmarks a year (roughly \$23,000 to \$30,000) gross profit, a figure that can't pay for hiring salesmen, training customers, providing support and investing in software.

After considering these data, Ericsson concluded what is needed is a different sales strategy.

Suppose, Ericsson said, it were to set up a string of Ericsson Support Centers around the country to develop vertical software, train customers and do support. Ericsson would tap for these centers some of the independent software companies and system houses struggling to make a living. They wouldn't come out of Ericsson's budget. These independent companies would be transformed and dedicated to the Ericsson product line. Each center would make part of its income supplying five to eight small independent dealers. The centers would supply the dealers with software and more or less "force" the dealer into vertical marketing.

Ericsson figures IBM will eventually command a 30 to 40 percent share of the European personal computer market. It's setting its sights on 10 to 15 percent for itself.



**In a world of
dumb emulators,
one finally got smart:
Rabbit™ 3270-PLUS.**

Ordinary 3270 emulators make a smart computer look dumb.

But not 3270-PLUS, the new Middleware product from Rabbit Software.

3270-PLUS allows your micro to integrate local applications with your 3270 network. With 3270-PLUS, you can pause to run local

applications without having to break the 3270 session. And resume without having to re-enter access codes.

You also get faster response. Thanks to a read-ahead feature that pulls down the next screen while you're working with the current one.

PLUS you can page back and forth through previous screens. Commit data to a printer or file. Call on helpful

tutorial screens. And more.

Rabbit 3270-PLUS is totally IBM compatible and designed for CTOS™* and UNIX™** -based systems.

For more information call or write today.

Another MIDDLEWARE™ product from

CIRCLE NO. 46 ON INQUIRY CARD

Write to Rabbit Software Corporation, Great Valley Corporate Center, One Great Valley Parkway East, Malvern, PA 19355, or call (215) 647-0440.

Name _____

Title _____

Organization _____

Address _____

City _____ State _____ Zip _____

**Rabbit
SOFTWARE**

Phone _____
My Micro System model is: _____

The OEM Software Company

*A trademark of
Convergent Technologies
**A trademark of
Bell Laboratories



PCOX™
Make a Great Display.

PCOX. They're the superior interfaces that turn PC's into fully functioning, intelligent workstations. PCOX high-performance PC-to-host system connections deliver what they promise—true flicker-free IBM 3278/9 emulation and optional menu-selected file transfers. Choose the fast, simple, cost-effective way to integrate PC's into IBM host networks. What could be more beautiful? Contact us today.

cxi

CXI, Inc. 10011 N. Foothill Blvd.,
Cupertino, CA 95014 • (408) 725-1881

See us at COMDEX
Bring This Ad For a Free Poster.

CIRCLE NO. 47 ON INQUIRY CARD

Mini-Micro World

INTERNATIONAL

a premium. He also recognizes the need for the logic to be implemented in compact low-cost circuitry such as programmable logic devices. Not surprisingly, Biewer also emphasizes STE's size problems, noting that its single-height Eurocard form factor measures only 6.3 by 3.94 inches. STD—at 6½ by 4½ inches—is only slightly bigger but does not have to accommodate STE's additional logic.

But an added advantage of adopting the Eurocard form factor is the possibility of housing an STE bus and its boards in the same enclosure as a VME or Futurebus system. Elsmore explains that VME uses all three 32-pin rows in one 96-pin DIN 41612 connector but only the middle row of the second DIN connector in its double Eurocard housing. STE's signals are all assigned to the outer two rows of one DIN connector, facilitating

integration with Motorola's VME bus. Elsmore believes that physical integration with Futurebus should be even easier because all Futurebus signals are assigned to the three rows of one connector, freeing all the pins in the second connector for STE.

Shields sees STE also being used in a VME system as the input/output bus in place of Motorola's own I/O bus. He notes that one manufacturer of VME-based computers, Victory Computer Inc., San Jose, Calif., is considering using STE in this way. Victory's engineering vice president, James Willot, acknowledges that his company plans to evaluate STE as an alternative to the Motorola I/O bus because of such STE advantages as support of multiple master boards. But Victory is delaying this plan until issuance of a final definition of STE.

Mostek Corp., joint developer of

the STD bus, is committed to the Eurocard form factor in the 16-bit arena and is copromoting the VME bus with Motorola. However, Mostek does not appear interested in promoting STE even in Europe. Mostek's European strategic marketing manager for systems technology, Winfried Osswald, believes that there is no great need for physical compatibility between STD and VME because they address widely differing markets. STD is mainly for process control. He notes that STD is well represented in most parts of Europe with the notable exception of West Germany, which is most devoted to the Eurocard. There, the Eurocard-based products of Siemens A.G. outsell STD. The 8-bit Siemens microcomputer board family employs a proprietary Siemens bus.

— Keith Jones

Siemens, Bull, ICL aim research at better knowledge-based systems

The know-how to build sophisticated management-support systems could be among the fruits of a Joint Research Institute being established in Germany by three of Europe's leading computer manufacturers—Siemens A.G., West Germany, Compagnie des Machines Bull, France, and ICL Plc., Britain. Staffed by 50 scientists, the institute will investigate the fundamental techniques to implement knowledge-based systems that will substantially improve expert systems.

The three companies are involved in publicly funded research schemes. These include the European Strategic Program of Research and Development (ESPRIT) backed by the Common Market and, in ICL's case, the British government's Alvey program (MMS, July, Page 81).

ICL technical director Mike Watson believes that, because knowledge engineering is vital to the institute's three backers, they need an initiative dedicated to knowledge engineering to augment ESPRIT.

The many companies participating in ESPRIT are diverse, and many have interests outside commercial computing. Knowledge engineering is just one of several technologies ESPRIT is investigating.

Walter Heilmann, coordinator of Siemens' participation in the institute, notes the field of knowledge engineering is large enough for several parallel research projects. Siemens, Bull and ICL are also working internally. ICL's Watson envisions his company's knowledge-engineering scientists typically

TEK MICROCOMPUTER
DEVELOPMENT SYSTEMS

**For the 68000 design team manager
whose job depends on the deadline.**

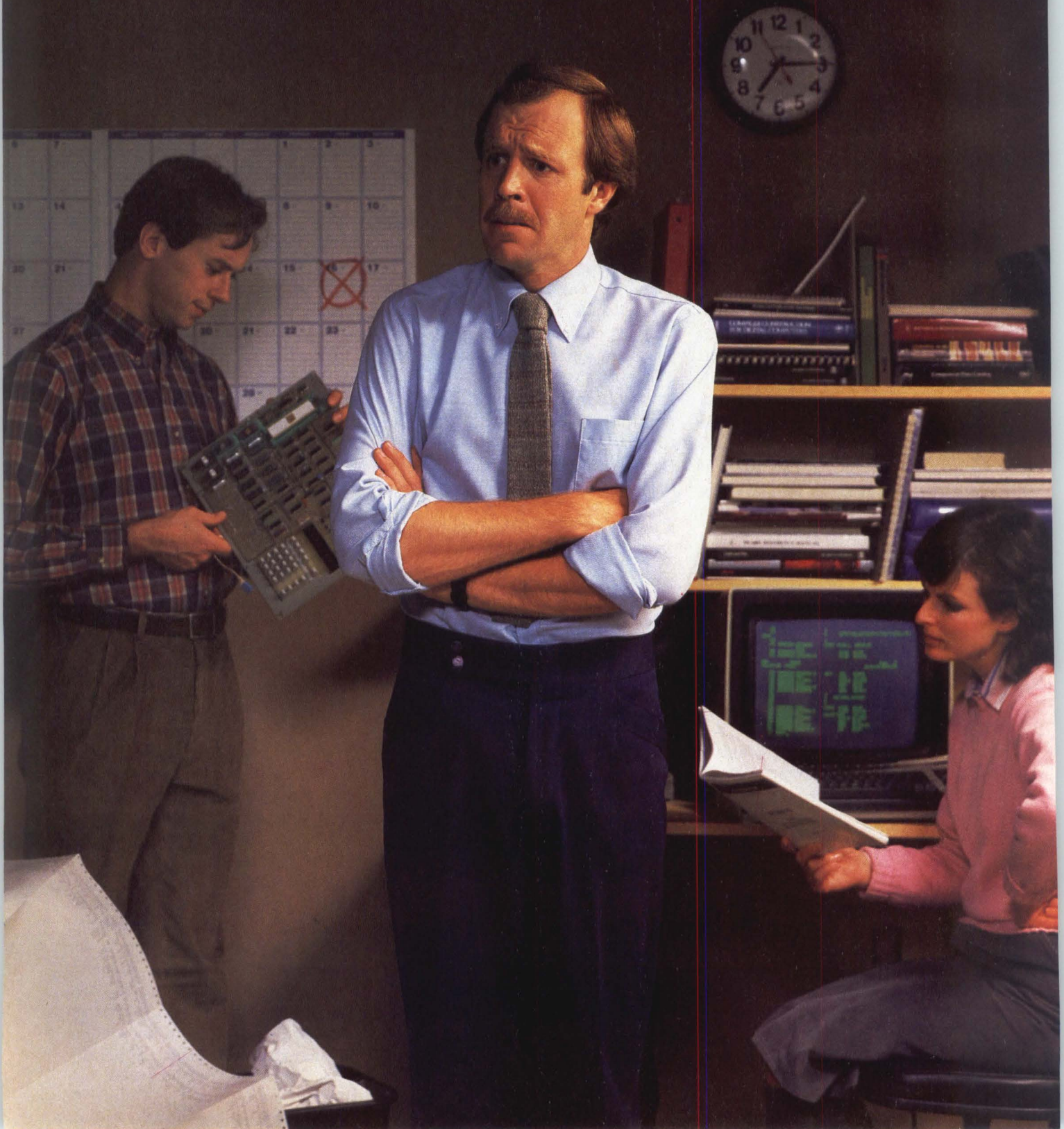

Tektronix announces 68000, 68008 and 68010 support.

The only productive choice for 16-bit design.

You've got deadlines to meet, and you can't afford to waste your engineers' time with desk-top development tools. So Tek brings you the power you need to get your project done, whether your team is designing with the 68000, 68008, 68010, or all three. Your design team will work faster, from software and hardware development through debugging and integration.

Tek LANDS saves time with Pascal and C design support.

The LANDS language-directed development system helps you finish your project on schedule. With the language-directed editor, you quickly track down syntax errors before compiling. Our microcomputer-optimized Pascal and C compilers with The Integration Control System* let you write

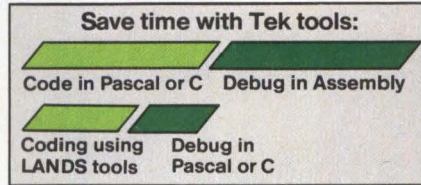

even device dependent code without assembly language. And then, you debug on your hardware entirely in Pascal or C.

Whether stand-alone or on your VAX™, you get the same tools.

Make sure your team's computing power is matched to the job at hand. Choose our 8560/40 stand-alone development systems with their own multiprocessing computer. Or select the 8540 integration unit and Tek's software, and turn your VAX into a powerful microcomputer design system, with all the capabilities of our proven tool set.

Either way, you can count on Tek's superior emulation to

get your products to market faster. Full speed, completely transparent emulation of the 68000, 68008, and 68010 lets you concentrate on your design,



not on the limitations of outmoded tools. And support for a wide variety of other chips with the addition of the appropriate emulator and software guarantees the return on your investment.

Call 1-800-547-6711 for technical details.

Call us for your new brochure and for data sheets on any of our emulators. Or contact your local Tektronix Sales office.

For further information, contact:

U.S.A., Asia, Australia, Central & South America, Japan Tektronix, Inc., P.O. Box 1700, Beaverton, OR 97075. For additional literature, or the address and phone number of the Tektronix Sales Office nearest you, contact: Phone: 800/547-1512, Oregon only 800/452-1877, TWX: 910-467-8708, TLX: 15-1754, Cable: TEKTRONIX
Europe, Africa, Middle East Tektronix Europe B.V. European Headquarters, Postbox 827, 1180 AV Amstelveen, The Netherlands, Phone: (20) 471146, Telex: 18312-18328
Canada, Tektronix Canada Inc., P.O. Box 6500, Barrie, Ontario L4M 4V3, Phone: 705/737-2700

*Patent Applied For

™VAX is a registered trademark of Digital Equipment Corporation.

```

end;~
U&R~
current := state;~
PROCEDURE wait(seconds : integer); EXTERN;~
(* waits for "seconds" seconds and returns *)~
FUNCTION pedestrian : boolean; EXTERN;~
(* returns true if a pedestrian pushed the crosswalk button *)~
PROCEDURE maple(newcolor : color); EXTERN;~
(* changes Maple Street light to "newcolor" *)~
PROCEDURE crosswalk(newmessage : message); EXTERN;~
(* changes crosswalk signal to "newmessage" *)~
BEGIN (* trafficlight *)~
current.light := green;~
maple(current.light);~
crosswalk(dontwalk);~
WHILE true DO ~
BEGIN~
WHILE NOT pedestrian DO (* nothing *) ;~
current.light := yellow;~
current.time := yellowlength;~
maple(current.light);~
wait(current.time);~
writeln;~
Parsing complete, no errors detected.

```

Language Directed Editor reduces compile time by detecting and correcting syntax errors.

Mini-Micro World

INTERNATIONAL

working at the institute for three years and then returning to ICL's laboratories.

Watson reveals that ICL's biggest effort will be in the knowledge-engineering part of Britain's Alvey program. But, he adds, "The Joint Research Institute will provide ICL with access to the European culture. We need the extra stimulus of outside ideas." ICL chose Bull and Siemens as partners because, explains Watson, "we have collaborated with each other for many years and understand each other." He points to close cooperation among the three companies within the European Computer Manufacturers' Association (ECMA), in which they have worked on formulating networking standards. Bull officials cite the roughly equal size of the three participants as another common trait.

The three partners will have equal and free access to the institute's research results but seem to have no plans to make this information available to other companies. Bull officials say U.S. company Honeywell Inc. is unlikely to have access to research results even though it works closely on development programs with Bull's mainframe division, Bull-Systèmes, formerly Cii Honeywell Bull. Likewise, ICL and Siemens will not let Fujitsu Ltd. in on their activities, despite the Japanese company's interest in knowledge engineering and its close trading ties with the two European companies. ICL and Siemens sell Fujitsu's large mainframes in Europe.

The three participants stress that their cooperation is confined to pre-competitive research. "We are not developing products," ICL's Watson states. "Our joint work will not lead to any specific box." Having acquired the fundamental know-how

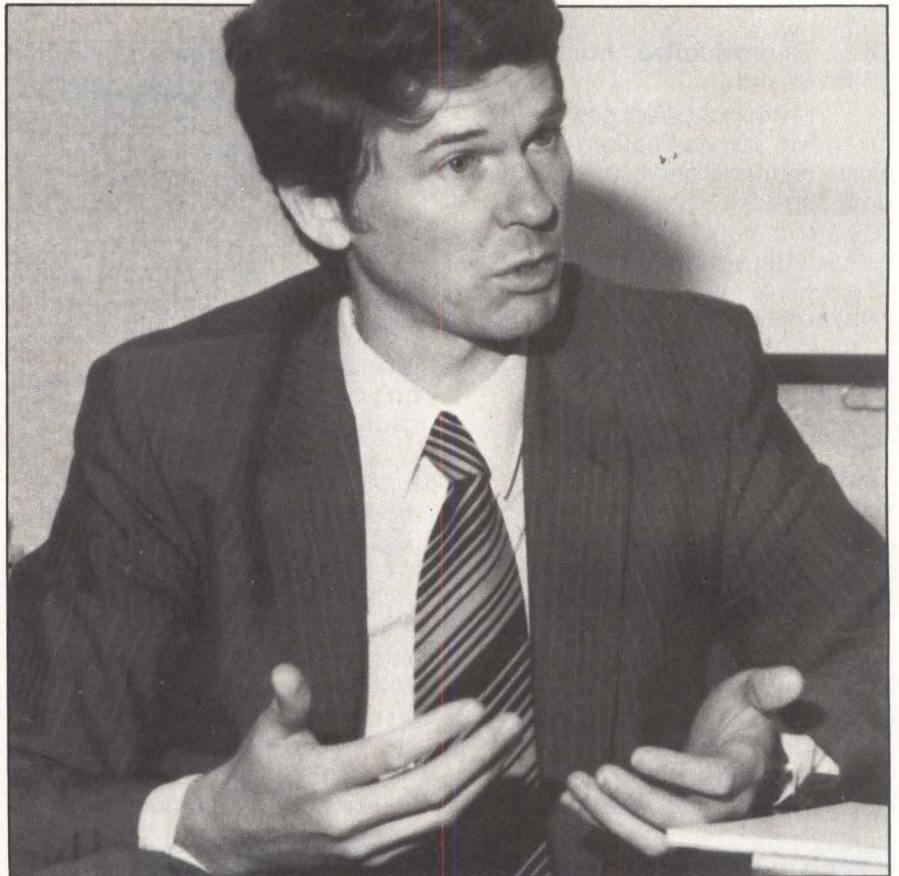

Mike Watson, ICL Plc. technical director, reveals that products based on work at the Joint Research Institute for knowledge-based systems may not appear until the end of the decade.

from the institute, the three companies will individually develop products. But Watson does not expect such products to appear before the end of the decade. He expects the systems—at least those requiring large knowledge bases—initially to require mainframe computer power. But he acknowledges that small machines are also potential hosts and sees them being used immediately as workstations. Heilmann at Siemens believes there are "many possibilities" for potential hosts.

Watson reveals that an important part of the institute's work will be investigating database structures for unstructured inquiries. The institute will also put much effort

into the man-machine interface and languages to implement knowledge-based systems, notably Prolog and LISP.

Current knowledge technology enables an expert to enter facts about his specialty. Those facts can then be used by a non-expert to tap the expert's knowledge in a question-and-answer session. Diagnosis is one application for such a system. Watson expects future knowledge-based systems to offer more sophisticated facilities, such as advising managers on how to reach business decisions and assisting in decision making by management groups. The systems, as a result, might help form company policies.

—Keith Jones

Net Results ...



Net results are what you get with **PerComNet™** ... the sophisticated, user-installable Local Area Network from PERCOM DATA CORPORATION.

PerComNet IBM® interface cards are available *now* to provide true networking capabilities for IBM and most IBM compatible personal computers. This includes the sharing of peripheral devices such as printers, modems, floppy disk drives, and all PERCOM DATA High Performance PHD™ Hard Disk Drives.

PerComNet provides these **net results**:

- Token passing reliability.
- Built-in 64K FIFO buffer, to speed data transmissions.
- Signal regeneration at each node to eliminate noise, regardless of network size.
- User installation simplicity.
- Optional NBS encryption for data security.
- Support for simultaneous voice/data transmissions.
- Operating system compatibility for MS-DOS™, CP/M®, UNIX™, and uNETix®. uNETix for PerComNet is distributed by Percom Data.

If you want **net results** ... PerComNet is the logical, economical and reliable choice. PERCOM DATA has a PerComNet OEM Evaluation Package* ready for your immediate use. The package includes all the hardware, and communications and file transfer utilities you need for configuring a network of three IBM PC computers. Package price is only \$1695.

To order your evaluation package or to get more information contact us today!

PERCOM DATA CORPORATION

11220 Pagemill Road • Dallas, Texas 75243

Name: _____ Title: _____

Company: _____

Address: _____

City: _____ State: _____ ZIP: _____

- I'd like you to send me more information.
 I'm very interested, please have your rep call me at _____
 I'd like to know more about your PHD Hard Disk.

PERCOM DATA
CORPORATION

Expanding Your Peripheral Vision

DRIVES • NETWORKS • SOFTWARE

11220 Pagemill Road, Dallas, Texas 75243 (214) 340-5800

1-800-527-1222

*Does not include operating system or application software.

PerComNet and PHD are trademarks of Percom Data Corporation. • IBM is a registered trademark of International Business Machines. • MS-DOS is a trademark of Microsoft, Inc. CP/M is a registered trademark of Digital Research. • UNIX is a trademark of Bell Laboratories. • uNETix is a registered trademark of Lantech Systems Incorporated. COPYRIGHT Percom Data Corporation 1983 • All prices, and descriptions subject to change with notice.



**AS PERSONAL AS A PC,
AS POWERFUL AS A VAX.†**

The ultimate UNIX[†] machine.

Not just a computer, but a problem-solving tool. Single- and multi-user. With *full* Bell Labs UNIX. Six languages. A high-performance 68000 processor. Multibus[†] for expansion.

Plus Tektronix-compatible graphics. Ethernet[†] capability. And up to two megabytes of no-wait-state memory, up to 21 megabytes of reliable hard disk.

All in a compact, low-cost desktop workstation.

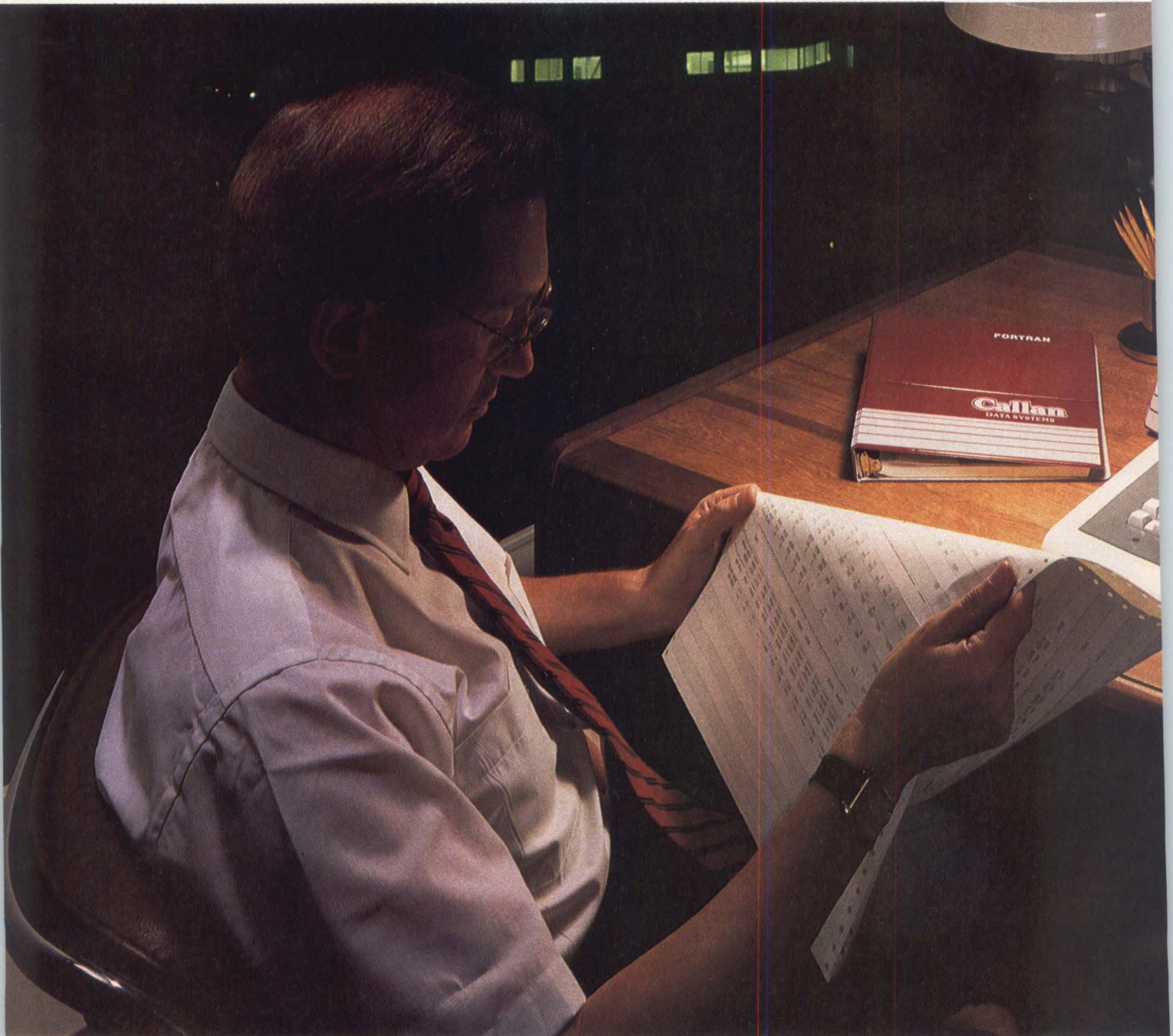

THE SHORTEST DISTA PROBLEM AND SOLUT

The Callan Unistar.

Unistar applications stretch from software development to medical electronics to engineering, industrial and business applications. And the Unistar has been benchmarked as faster than the VAX-11/730.

Yet it is priced like the more personal computer that it is.

If you're a software developer, an OEM, or an end-user who wants to maximize your performance at

the minimum cost and risk, ask about the Unistar family. The shortest distance between problem and solution.

For more information or the name of your nearest distributor, call: Callan Data Systems, 2645 Townsgate Road, Westlake Village, CA 91361. Telephone 800-235-7055 (In California, 805-497-6837). TWX 910 336 1685.



†Trademarks: Callan, UNISTAR/Callan Data Systems. UNIX/Bell Labs. VAX/Digital Equipment Corp. Multibus/Intel. Ethernet/Xerox Corp.



NICE BETWEEN ION: CALLAN UNISTAR.™

SEE US AT COMDEX HILTON,
BOOTH #7430.

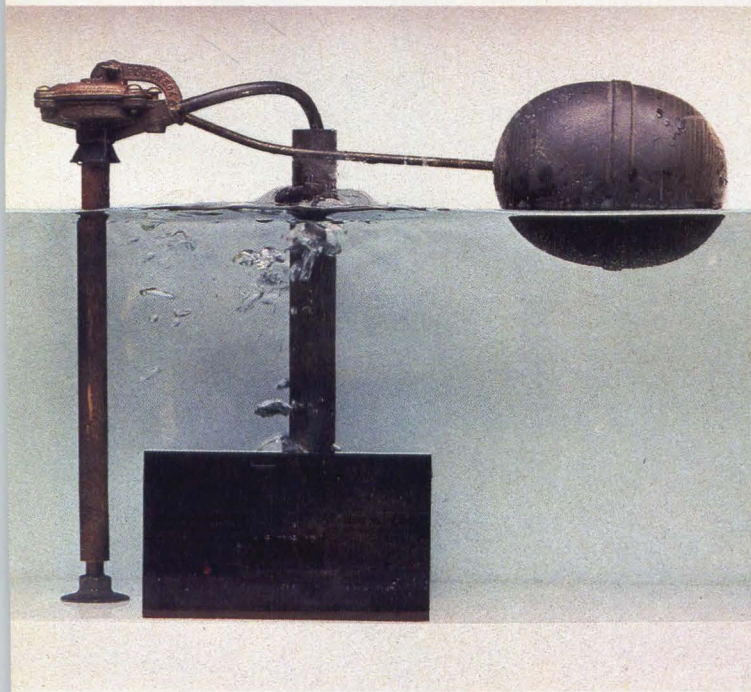
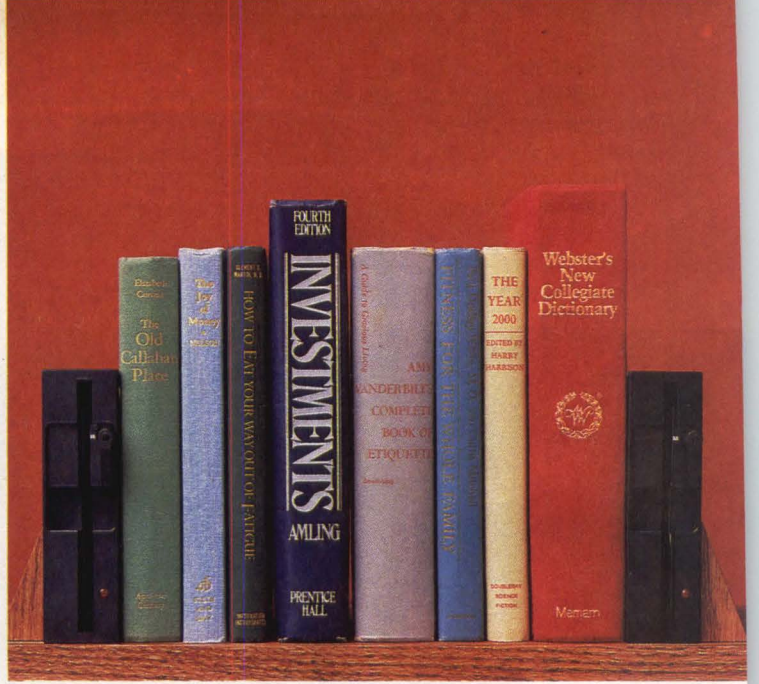

Six things you can do with your obsolete floppies.

Floppies were fine in their day. But they just don't make sense with the professional desktop computers of today.

What's the answer? The DMA 360 removable 5¼" Winchester. It's exactly the same size as a 5¼" half-height floppy drive — but that's where the similarity stops.

The DMA 360 gives you hard-disk reliability. Floppies don't.

The DMA 360 protects your data in a totally sealed cartridge. Floppies don't.

The DMA 360 packs 7.5 megabytes on a single ANSI-standard cartridge. Floppies don't. It takes up to 25 floppy disks to achieve an equal capacity.

The DMA 360 even has a lower cost-per-megabyte than

a floppy. But it gives you so much more.

Like an average access time of 98 milliseconds. A transfer rate of 625 kilobytes per second. And an error rate that's on par with the most reliable conventional Winchester disk drives.

There's no way you'd get that kind of performance from a floppy!

In fact, anything you can do with a floppy, you can do even better with a DMA 360. That's why we call it the floppy replacement.

For more information on what you can do with your obsolete floppies, write DMA Systems, 601 Pine Avenue, Goleta, CA 93117. Or call us at (805) 683-3811, Telex 658341.

Introducing the floppy replacement: DMA Systems' new half-height removable 5¼" Winchester.



DMA
SYSTEMS

The Removable Winchester Company.

See us at COMDEX Booth #166
CIRCLE NO. 50 ON INQUIRY CARD

A Memory to Treasure

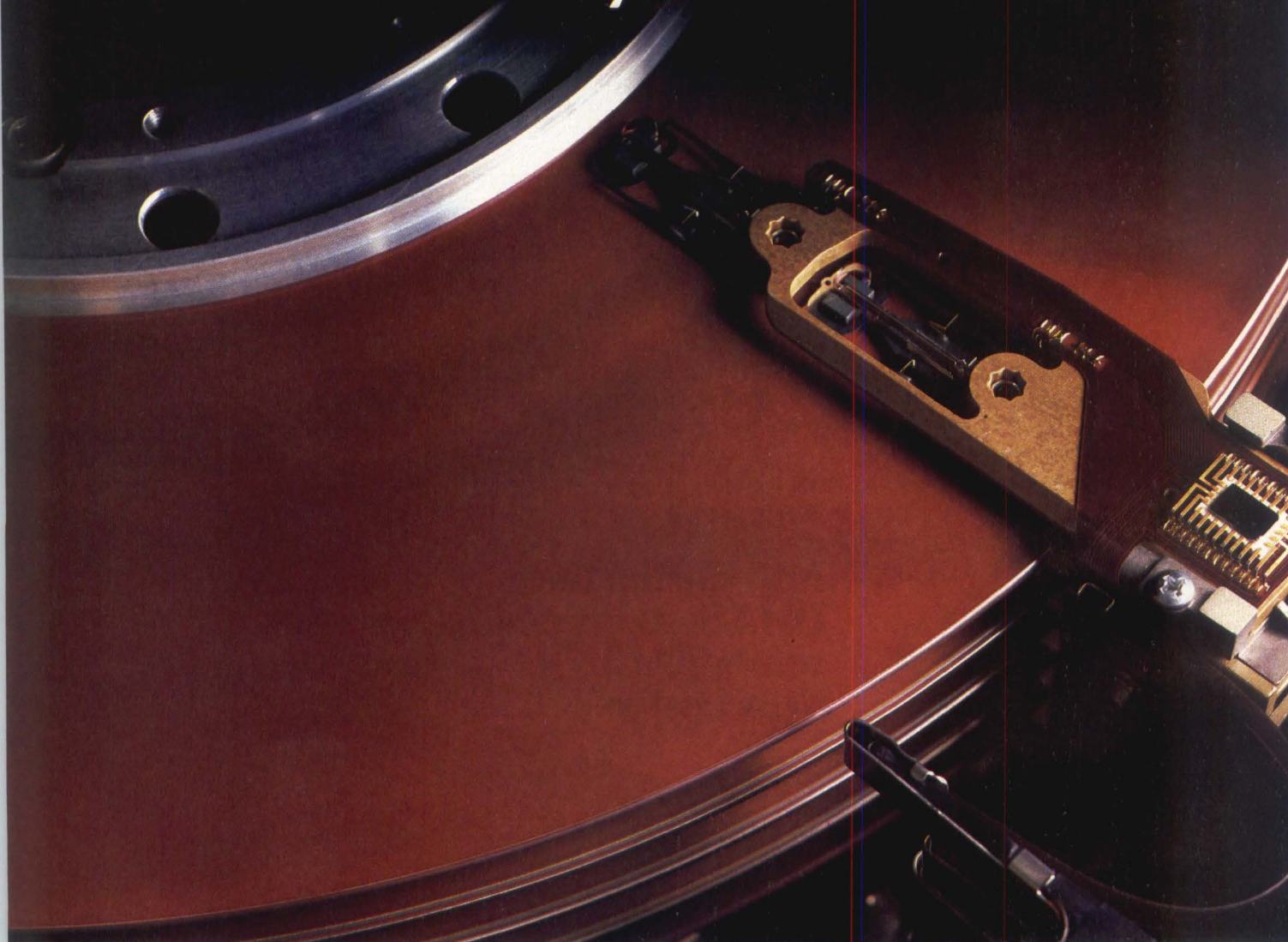

Century Data's 300 Megabyte Winchester Disk Memory

For OEMs, this high-end disk memory is not only an exciting advance in technology, but a memory to treasure.

And AMS-315 is more than twice as reliable as 300 megabyte removable pack disk drives used in the past. It plugs into the same SMD interface and operates with the same software as removable pack drives. This large capacity Winchester disk memory needs only one-third as much room to provide 300 megabytes of memory.



Best of all, it costs one-third less than a removable pack drive and is now available in OEM quantities.

To configure a new computer system or upgrade an existing one, the AMS-315 is the memory to treasure.

Century Data Systems
1270 North Kraemer Blvd.
Anaheim, California 92806
(714) 999-2660



Century Data Systems
A Xerox Company

Mini-Micro Interpreter

An analysis of news, issues and trends affecting the computer industry

Crowded disk drive market forces entrepreneurs to be cautious

By Robert A. Sehr

The hills around Santa Clara Valley are alive with the sound of money. For a while, a new company with plans to manufacture 5¼-inch disk drives seemed to form there every month. Rather than offering innovative products, however, most companies were cautious: they took a predecessor's successful idea and made it more marketable. Those with new engineering ideas could hope for modest sums of venture capital and could expect skeptical looks from others who gladly let them take the risk of opening a new market.

The most successful 5¼-inch disk drive companies in the OEM market are Seagate Technology, Scotts Valley, Calif., and Tandon Corp., Chatsworth, Calif. The annual revenues of each have grown to more than \$100 million in the past three years, despite the fact that neither made startling technological advances. Seagate took an early risk by reducing the 8-inch Winchester to 5¼ inches. However, Seagate founder Al Shugart had laid the groundwork for the smaller drive when the company he had founded previously, Shugart Associates, developed the 5¼-inch minifloppy drive. Consequently, a market for Winchesters working in conjunction with minifloppies already existed.

Tandon entered the market by using Seagate's design—willingly shared by the then-small Seagate eagerly seeking another manufacturing source—and capitalized on having the right product at the right time. As large established companies like Control Data Corp., Memorex Corp. and International Memories Inc. were competing in the 8-inch disk drive market, Seagate and Tandon swam alone in an open sea of orders.

In the past three years, Seagate and Tandon have spawned much competition, most of it catering to the same low-end market for 5¼-inch drives. With 200,000 5¼-inch drives shipped in 1982, according to industry analyst James Porter in his *1982 Disk/Trend Report*, and IBM Corp.'s PC XT making 10M-byte Winchesters standard for top-of-the-line personal computers, there appears to be plenty of incentive to enter the market.

Despite the market's growth, manufacturers face a problem. The 5¼-inch Winchester industry has very low margins, the result of low-cost, frequently offshore manufacturing that doesn't permit much sophistication.



Eugene Kleiner, a partner in venture capital firm Kleiner, Perkins, Caufield & Byers, says it took his partnership only five to six months to discover that Quantum Corp. would succeed and Ontrax Corp. would fail. In addition to providing financing, he adds, it's the duty of venture capitalists to help focus a product.

New companies stick to old technology

This problem led even those companies formed in 1982 to enter a new market for high-capacity 5¼-inch drives to be cautious rather than innovative. Some industry observers point to drives from Maxtor Corp. as having some gee-whiz features such as a motor in the spindle. This increases capacity by leaving enough room within the 5¼-inch box to stack eight platters. Maxtor claims to be merely "repackaging solid, reliable technology." However, Maxtor marketing director Skip Kilsdonk admits that the company has bet its future on the success of volume production of the high-capacity (140M- to 380M-byte) drive. "This is the product that the company is based upon," he comments. "I don't see us revising it." Maxtor founder and president Jim McCoy agrees. "Our risk is in the execution; that is, high-volume production," he emphasizes.

Few of Maxtor's competitors are willing to take even that much of a risk. Most pattern themselves on what has already worked for older, larger disk drives. Two other entrants in the 5¼-inch market, Atasi Corp. and Evotek Corp., use the same embedded-servo and voice-coil actuator design that served in 8-inch and even older 14-inch drives. However, both companies are evaluating new designs: combinations of plated media and, ultimately, thin-film heads to increase bit and track densities. But they're waiting for these technologies to

The Interpreter

be tested in other form factors before risking change in the cutthroat 5¼-inch market.

One exception to the mass retreat from risk is Tandon. The company recently demonstrated its ability to take big risks by entering the ½-inch tape drive market with a low cost, 50M-byte non-standard cartridge positioned to compete against low-end ¼-inch tape drives in the 5¼-inch form factor. The drive is expected to sell for less than \$700 each in volume and fits between the low end of the market for ½-inch tape drives and the high end of the market for ¼-inch tape drives.

Miniscribe Corp., another bold company, has risen quickly in relation to the two market leaders by taking a risk with a one-platter, 5¼-inch Winchester that has

Other industry watchers believe that the recent economic slowdown made venture capitalists more careful in doling out their millions. But funding of 26 thin-film media companies in the past year contradicts such reasoning.

Still others believe that the market is simply too crowded and price conscious to risk trying new technologies. Market leader Seagate might be able to afford to put its plated-media-based 706 cartridge drive on hold because of "concerns about the availability of plated media," as the company announced in April. But other than Tandon, the ranks of 5¼-inch Winchester manufacturers hold few contenders that can afford large expenditures on research and development.



Dieter M. Schulze, inventor of Ontrax's controversial actuator, believes the failure of Ontrax can be attributed directly to the principals' lack of organizational ability. Schulze explains that management spent most of its time on non-management duties.

the same capacity as Seagate's two-platter drive. Despite its success, though, Miniscribe still approaches new markets and products cautiously. Industry observers cite the company's delaying introduction of its 3½-inch Winchester until Comdex in November, despite competitive pressures to introduce it at the 1983 National Computer Conference last May.

Some observers view this caution as a sign of the industry's maturity. Only three years ago, companies differed widely on standards for 8-inch disk drives, causing manufacturers such as Perdec Computer Corp., BASF Systems Corp. and Siemens Corp. to leave the market for 8-inch drives. But others criticize that viewpoint, giving the current battles to standardize the sub-5¼-inch form factor and the high-capacity 5¼-inch interface as evidence that the disk drive industry is still immature.

Failure teaches caution to onlookers

The industry-wide climate of caution may have had a specific starting point: May 1981. That's when Ontrax Corp., Sunnyvale, Calif., shut its doors only 8 months after heralding a "revolutionary" product that it hoped would forever change the disk drive industry. Ontrax officials touted their proprietary actuator as capable of the "performance of a voice-coil motor at the price of a stepper" (MMS, January 1981, Page 39). With the proprietary actuator, Ontrax's 8-inch drive was to achieve a then-unprecedented 136M-byte capacity with a track density of 960 tracks per inch. The actuator was comprised of a series of concentric sleeves, each capable of specified linear movement. The design cut costs by eliminating the permanent magnets required by other voice-coil actuators and by using lower cost powder metal.

The company secured \$1.5 million from venture capital firm Kleiner, Perkins, Caufield & Byers and attracted interest throughout the disk drive industry. The honeymoon, however, was short. Just four months after announcing the product, Ontrax announced some "production problems" that would delay shipments of products with the actuator. In fact, the engineering team had difficulty in getting the actuator to work. "I worked harder at Ontrax than any other place I have ever worked," says Dieter M. Schulze, inventor of the controversial actuator, who was the company's vice president of advanced development. "I did not get enough assistance, so my time was spent doing preparation work like machining parts rather than perfecting the actuator."

Schulze says that, if Ontrax had been given more time and money, the actuator would have worked. So confident is he of its eventual success that he is developing a new product around the invention. "Venture capitalists do not appreciate the technical effort that

GET THE BEST OF BOTH WORLDS.

So you're shopping for disk drives. We'll bet you're looking for high-tech, high-quality drives from the Orient, right? And while you're at it, you'd like to find a supplier whose pipeline to the U.S. is as reliable as his product.

Only you know you'd rather deal with a company based in this country, right? Particularly one whose corporate heads are not only here, but reachable. Even reasonable.

You also know by now that such companies don't exist, right? Wrong. One does. MPI.

Our high-volume plant in Singapore together with design and management headquarters in California give you, quite literally, the best of both worlds. Oriental product quality by the boatload.

And American response by phone. Or in person.

If you'd like to test the veracity of that statement, MPI will be glad to supply you with competitively priced 5¼" full or half-heights, 8" Slimlines, or 3" or new high capacity 3¼" microfloppy drives to evaluate.

Just call. And see if you don't reach somebody important.



MPI™

A GTS SUBSIDIARY

R&D YOU CAN DEPEND ON: RESPONSE AND DELIVERY.

MPI, 9754 Deering Ave., Chatsworth, CA 91311, Phone (213) 709-4202. Twx (910) 494-1213.
MPI-EUROPE, 11A Reading Rd., Pangbourne, Berkshire, RG8 7LR, ENGLAND. Tel. (0)7357 4711, Twx 848135 MPI EURG.

**CIRCLE NO. 52 ON INQUIRY CARD
COMDEX BOOTH 5162**

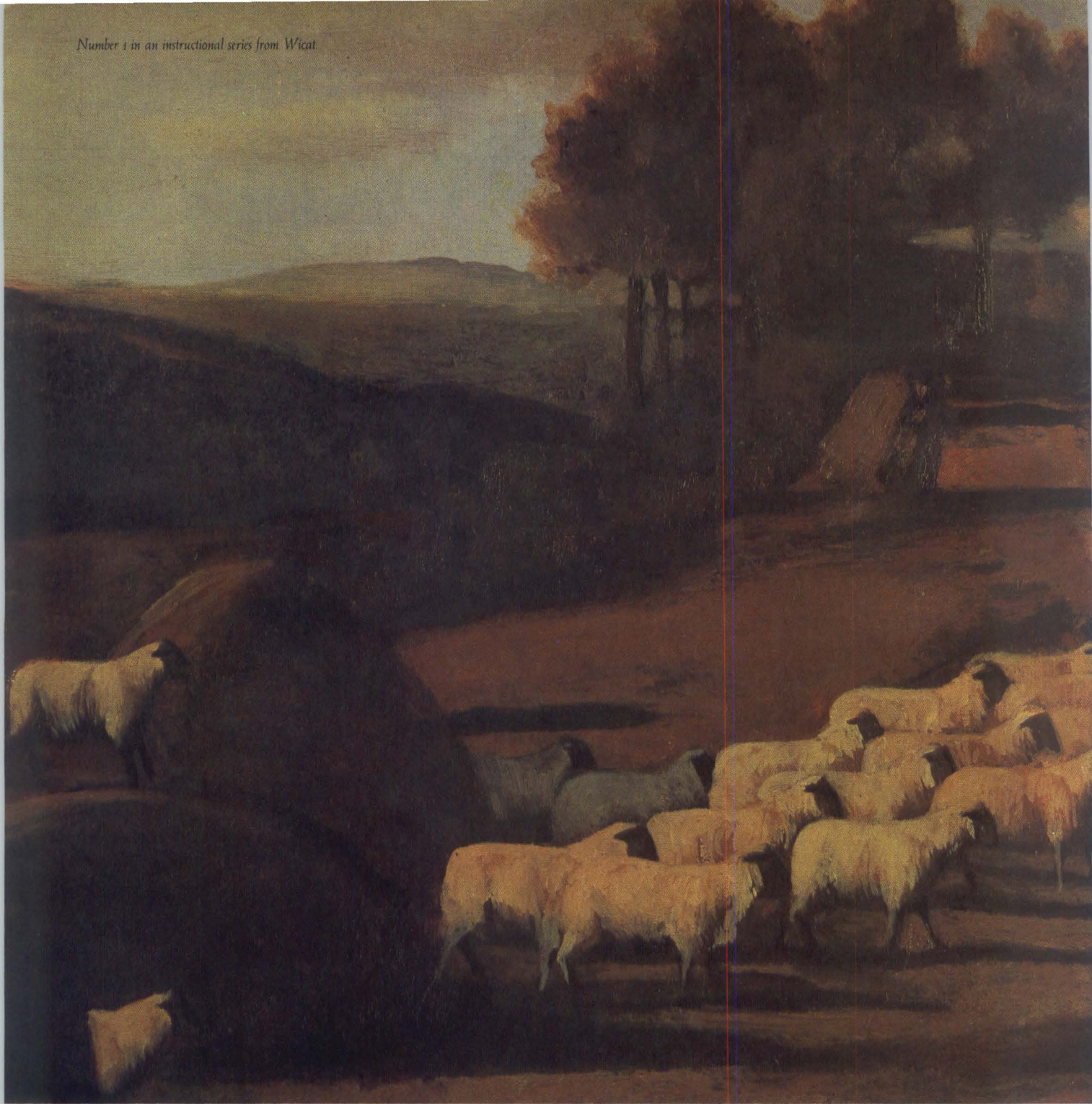

THE LEADING EDGE OF MINI

It's been going on for years.

Somebody comes out with a grown-up version of last year's mini. It sets a new standard of performance. So the whole industry follows along.

Not to be outdone, somebody else sets a new standard for price. And everybody rushes to

catch up all over again.

There's only one little problem. So far, nobody's ever given you leading edge performance and a hot new price on the same system.

Well, at Wicat, we took a good hard look at this particular kind of progress. And headed 180 degrees the other way.

Instead of parading out one grown-up mini after another, we created the first generation of grown-down mainframes.

There are seven of them in all, from a single-user desktop to a full-blown 64-user system. And from the bottom of our line to the top, we'd like you to compare our price/performance



COMPUTER TECHNOLOGY.

to any grown-up micro or mini you can think of.

Better yet, every one of them gives you the same mainframe operating system. So you can move up to a whole new level of performance. Without sacrificing one cent of your original software investment.

What's the operating system?

That's your decision. You can have our own MCS, or the industry standard UNIX®. And we give you all the language compilers you could ask for. Twelve of them, at last count.

So if you're ready for a direction that makes a lot more sense, call or write us for complete information. Wicat Systems,

CIRCLE NO. 53 ON INQUIRY CARD

P.O. Box 539, 1875 South State, Orem, UT 84057. (801) 224-6400.

We'll show you how to stay right out there on the leading edge. Without going over it.

WICATsystems™

The grown-down mainframes.

The Interpreter

goes into a product." he contends. "They are more interested in the people running the show. Given the choice of an 'A' team with a 'B' product, and a 'B' team with an 'A' product, they would go for the former."

Not true, asserts Eugene Kleiner, a partner at Kleiner, Perkins, Caufield & Byers. "We really must have both—an 'A' team and an 'A' product—or there's no sense in investing." Kleiner, whose partnership made successful investment in such companies as Quantum Corp. and Prime Computer Inc., says that Ontrax's experience was unusual. "Usually, a company fails because of a marketing problem. This time, it failed because it [the product] could not be manufactured."

That usually doesn't happen, Kleiner says, because he and his partners have or can find the technical expertise to evaluate a product's potential. There was common agreement in Ontrax's case that the actuator could be manufactured. When the venture capitalists discovered that they were wrong, they immediately pulled the plug on the operation.

"It's a sad thing to see a company die," Kleiner observes. "But, in the case of Ontrax, it was done mercifully with as little pain and as little loss of money as was possible. At least it was not a lingering death."

Although he says company officials hoped to ship drives with standard actuators while working on the proprietary actuator, Kleiner believes the effort would have been fruitless. It would have meant throwing "good money after bad," he concludes.

Lesson proves expensive

A mature market like the one for disk drives tolerates few mistakes. "When a company has already had many hiccups, it's not going to make it," Kleiner maintains.

Inventor Schulze asserts that the venture capitalists gave Ontrax and its founder, Joseph D. Koenig, a bad deal. "For \$1.5 million, Koenig gave up more than 50 percent of the company," Schulze comments. "As a result, the venture capitalists had a more powerful voice in the operation than they should have."

Koenig, who is starting a medical systems company in Sunnyvale, Calif., does not want to comment on his Ontrax experience. "I'm kind of high right now on my new company, and Ontrax is better left behind us," he states.

The lessons of Ontrax, however, have not been left behind: they stand as a warning to other engineering-driven companies to make sure a product can be manufactured before claiming so publicly.

Another manufacturer of 5¼-inch drives that has a



Jim McCoy, co-founder of Quantum Corp., started Maxtor Corp. last year. McCoy says Maxtor's product line presents no more of an engineering challenge than Quantum's 8-inch drives did.

proprietary actuator is Applied Information Memories Inc. (AIM), Milpitas, Calif. The company has been careful to bill its linear actuator as a "technologically simple" design, and it delayed public comment until September. The company says that, although it expects eventually to offer perpendicular recording products, it will first ship a more cautious product employing state-of-the-art magnetic recording.

"We're not inventing any machinery here," says Arnold Cooley, AIM's vice president of manufacturing. "Our greatest fear is that the design is so simple we will have a lot of companies reverse-engineering our drive within a short time of its introduction."

Who is left to experiment with untried technology? In the disk drive market, the door is open only to the company most observers feel can withstand market rejection: IBM. With its recently introduced non-standard 4-inch floppy disk drive that has various rotation speeds and uses non-standard media, IBM is ready to fill the bill, as it has many times. It is also possible that the company will take the 4-inch form factor into the Winchester arena in the not-too-distant future, provided the floppies gain acceptance.

"Technology simply cannot stand still in our business," says William A. Wachs, senior OEM marketing representative of IBM's Information Products Division, Boulder, Colo. "Someone has to take the lead. If it is left to us, so be it." □

**Archive cooked up
the perfect solution
for Winchester
backup.**

**We started with
philosophy for building**

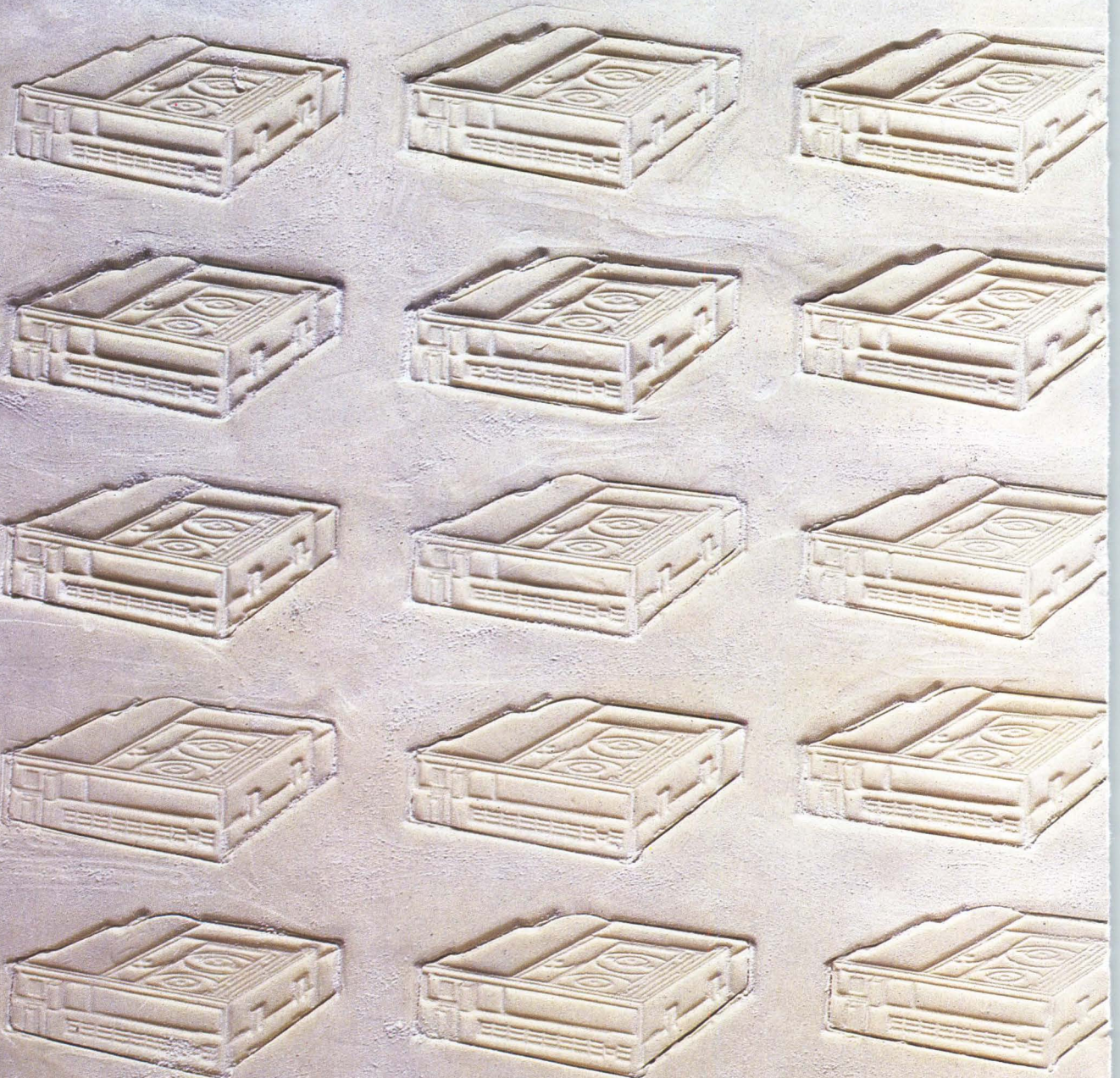

h a whole new ding 1/4" streamers.



Mass production.

Our goal was to create a design so simple and a production line so unerringly accurate that we could turn 1/4" streamers out by the thousands with cookie-cutter consistency.

At Archive, that goal was met. In the last three years, we've shipped out more than 50,000 streamers—well over a million megabytes of storage!

Others are still learning how to build streamers in quantity. But we perfected our production process years ago.

We already have everything in place. Our equipment and test gear are on-line and working. Our people are trained and have the know-how to get the job done. And we've got solid relationships with reliable suppliers we can count on.

Today, we're shipping over 5,000 streamers each month. And everything is ready to boost our capacity to 15,000 streamers per month.

But we're not stopping there. We're currently in the process of increasing our operations even further.

Our goal is to always keep our production capability greater than demand.

This way our customers can be sure that if anybody is going to be able to turn out a batch of streamers, it's Archive.



Scorpion Half-Height
5 1/4" Streaming Tape Drive.

**Then we rejected
of acceptable**



the industry's idea failure rates.



A lot of suppliers seem to be perfectly satisfied to deliver a product with 90%, 80% or even 70% reliability rates. We find that totally unacceptable! Our reliability rate is 98%—and we're still not satisfied.



We're shooting for 100% reliability. And to make sure we reach it, we're constantly improving our quality control process and manufacturing techniques.

For example, our recent advancements in LSI technology have reduced the number of parts in our drives by 40%. That means our newest streamers have fewer things that can go wrong.

We also have one of the industry's most extensive quality control programs. Out of the total time it takes to build a streamer, well over half is devoted to testing. In fact, a streamer must pass dozens of inspections before it's ready for shipping.

But in-plant inspections aren't enough. Sometimes the reason a drive fails is because it isn't being used correctly.

To prevent problems like these, over half the people in our marketing organization are qualified to provide you with technical and applications support.

We also offer a two-day training program that will teach you everything you need to know about correctly operating and integrating a streamer.

The way we see it, as long as we keep rejecting the idea of acceptable failure rates, you'll never have any reason to reject an Archive streamer.



Scorpion Full-Height
5 1/4" Streaming Tape Drive.

The result: In techno production, nobody



logy, experience and stacks up to Archive.



At Archive, we ship nearly three times as many streaming tape drives as the rest of the industry combined.

That shouldn't be too surprising. We've also had more technological breakthroughs than the rest of the industry combined. For example, we were the first streamer manufacturer to successfully use LSI technology.

Going back to our early days, one of the reasons we were able to build the first 1/4" streamer that worked is because we were the first company to fully study and understand the physics and dynamics of the 1/4" cartridge, as used in a high-density, high-performance streaming mode.

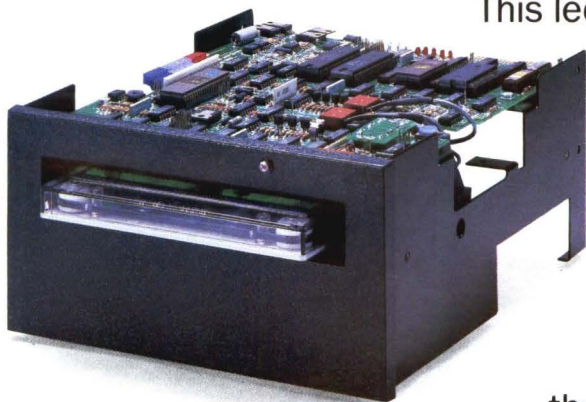

This led to the development of our unique phase-locked-loop that follows the instantaneous speed variations that are inherent in the cartridge.

What's more, Archive's designs were the basis for the industry's standard QIC-02 interface and QIC-24 recording format.

As you can see, even the competition depends on Archive for experience. You should, too. For more information, contact the Archive office near you.

Sidewinder 8" Streaming Tape Drive.

Where to find the freshest ideas for Winchester backup.

Corporate Office
ARCHIVE CORPORATION
3540 Cadillac Avenue
Costa Mesa, CA 92626
(714) 641-0279
Telex: 4722063
Domestic Telex: 183561

Southwest Sales Office
ARCHIVE CORPORATION
3540 Cadillac Avenue
Costa Mesa, CA 92626
(714) 966-2335
Domestic Telex: 183561

Northern Sales Office
ARCHIVE CORPORATION
2083 Landings Drive, Suite 9
Mountain View, CA 94043
(415) 969-7418

Eastern Sales Office
ARCHIVE CORPORATION
118 Sandstone Circle
Londonderry, NH 03053
(603) 434-7755

National Distributor
HAMILTON/AVNET
45 Locations

International Distributors

England (Oxon)
THAME SYSTEMS LTD.
(084) 421-5471

Switzerland (Wil)
DATACARE LTD.
(73) 220592

France (Z.I. De Buc)
MB ELECTRONIQUE
(03) 956-8131

Germany (Munchen)
IST GMBH MUNCHEN
(89) 8127053

Italy (Torino)
D.D.P. S.r.l.
749-7635

Israel (Kiryat Haim)
ELBATRON
ELECTRONICS LTD.
4-725892

Sweden (Bromma)
SCANOPTER AB
(82) 894-25

Australia (Rozelle)
AMPEC
(02) 818-1166



ARCHIVE
CORPORATION

WORLD'S FASTEST MULTIBUS DYNAMIC RAM BOARD

- Minimum RAM Read Access Time of 20 Nsec
- 4K Bytes of On-board, High Speed Cache Memory
- 512K Bytes or 2 Megabytes of Dynamic RAM
- Dual Bus Architecture Allows Fault Tolerant and Clustered Processing Configurations
- Error Detection/Correction Provide High System Reliability
- Self Initialization During Powerup
- Error Syndrome Bit Latching
- Maximum MTBF and Minimum Down Time

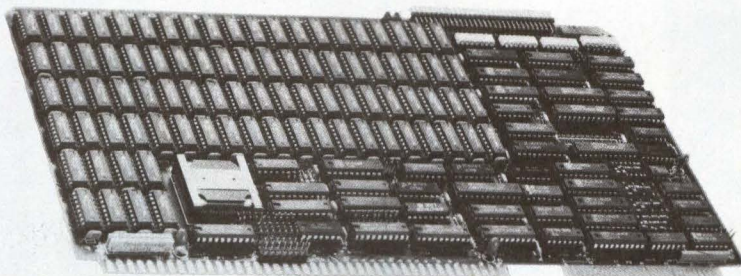

Easy to say, but we *deliver* the world's fastest RAM.

Why is our RAM faster than the competition?

Because our new HDMC-512 and HDMC-2MEG RAM boards have 4K bytes of integrated high-speed cache memory on board. This means a dramatic improvement in system performance at a bargain price when you consider the cost/performance ratio.

Why put up with speed degradation due to memory management, bus arbitration and older processors—they are all performance stealers. The HDMC SERIES puts

performance back into your system. And by lowering the cost-per-user, it gives you a more cost-effective product.

The on-board cache is transparent to the system processor or software and allows for a minimum RAM access time of 20 nsec. Error detection and correction (EDC) mean maximum MTBF and minimum down time. The EDC initializes itself at powerup so that you can add the board to existing systems with no software overhead.

Can you afford *not* to have the world's fastest multibus dynamic RAM board?

MEASUREMENT SYSTEMS & CONTROLS

1601 W. ORANGEWOOD AVENUE
ORANGE, CALIFORNIA 92668
(714) 633-4522 TWX/TLX 910-593-1350 SYSTEMGRP ORGE
CIRCLE NO. 54 ON INQUIRY CARD

Meet **supermax**

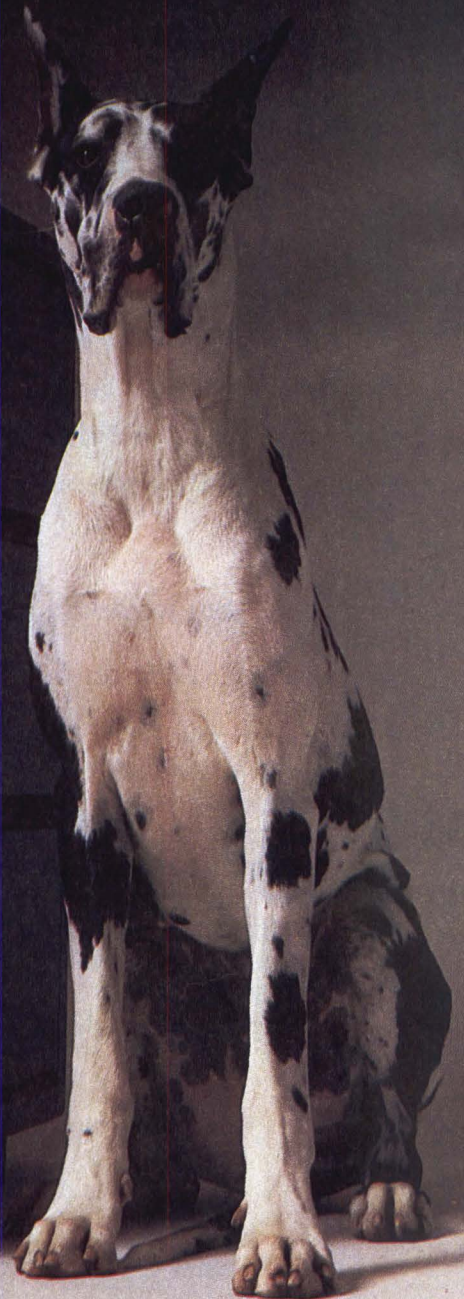
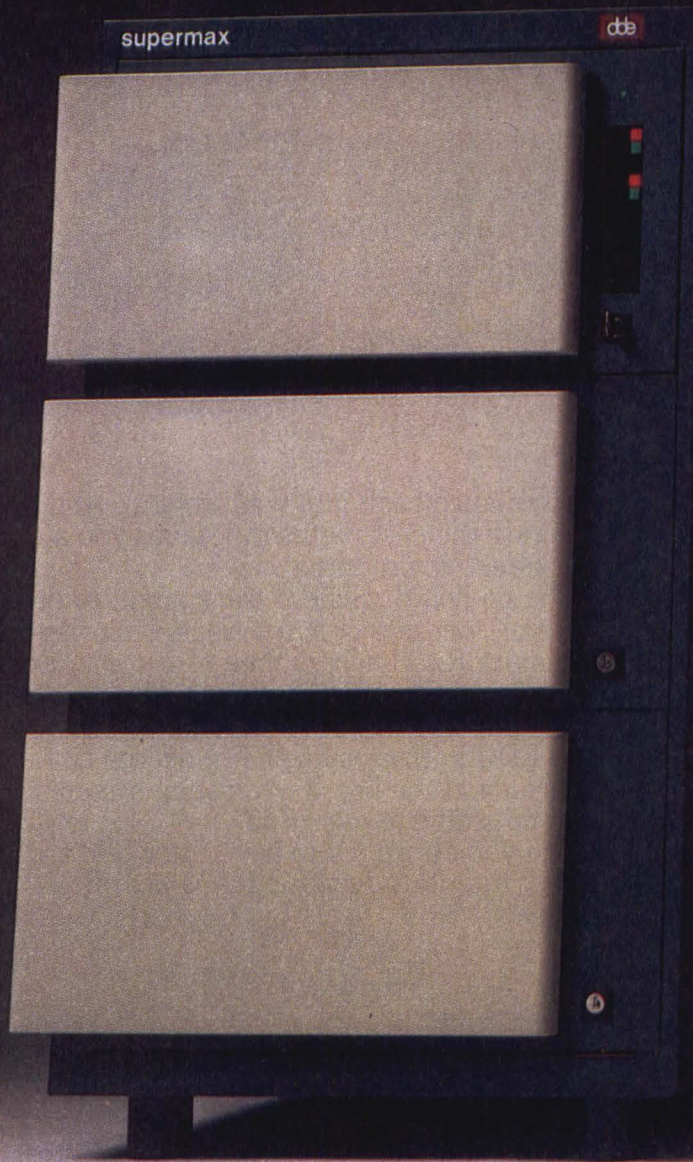

-the great dane at comdex Las Vegas

Supermax is more than a "super-micro"

Hardware

Power:

Multi-CPU, 1-8 MC68000 CPUs
6-4.8 Mips performance
32 bit architecture
Intelligent I/O controllers

Expandability:

1 to 8 MC68000 CPUs
256 KB - 128 MB
Up to 128 users
10 MB - 10 GB hard disk
Modular construction

Reliability:

Standard ECC
No-break battery backup
Remote diagnostics

Software

Operating System:

Multi-CPU
Multi-user/tasking
UNIX™ System III compatible
Berkeley enhancements
Relational Database

Languages:

Pascal
C
ANSI '74 COBOL
Fortran '77
Business Basic

Communications:

2780/3780
JES 2/HASP
3270 SNA and BSC

Our new multi-CPU SUPERMAX is more than a super-micro. It competes with them, but can grow to a size and a power, with a price performance that cannot be matched by either super-micros or super-minis.

SUPERMAX gives OEMs and distributors an ideal vehicle for rapid development of new, and expansion of existing markets. Its unique architecture satisfies user requirements for flexibility, reliability, and longevity.

OEM's and distributors:
Choose the cost-effective solution

- it is available now!

See it at the Hotel Riviera,
Booth R 8412.



Danish Data Electronics A/S
207, Herlev Hovedgade
DK 2730 Herlev, Denmark
Telephone: int. +45 2 84 50 11
Telex 35258 dde dk

UNIX is a trademark of Bell Laboratories

CIRCLE NO. 55 ON INQUIRY CARD

IBM-PC-compatible single board computers. \$249 each!

In large OEM quantities.

Standard features

- 8088 (4.77 MHz) CPU
- 64K bytes of RAM with parity
- 8K bytes of EPROM
- 2 serial ports, 50 to 9600 baud

- keyboard port (IBM compatible)
- 1 parallel port, 34-pin connector
- 5 expansion slots (IBM compatible)
- speaker port

- external reset port, 2-pin connector
- 8 levels of interrupts
- BIOS on ROM supports MS DOS, CP/M-86, concurrent CPM, and Qunix
- 8 1/2" x 12" multi-layered board

Options

- 256K (total) bytes of RAM with parity
- 32K (total) bytes of EPROM
- 8087 high speed math co-processor
- 4 additional 62-pin expansion slots

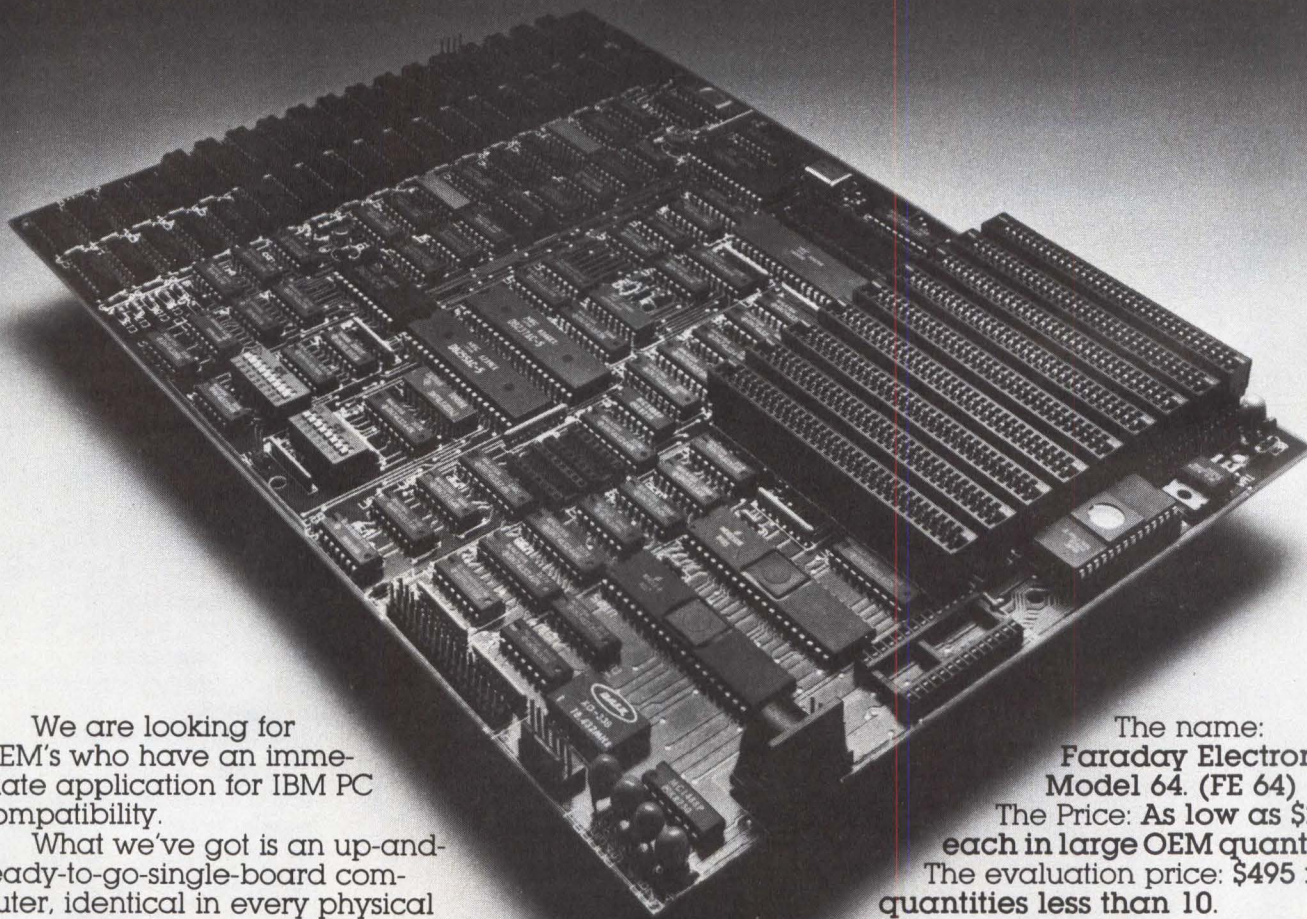

We are looking for OEM's who have an immediate application for IBM PC compatibility.

What we've got is an up-and-ready-to-go-single-board computer, identical in every physical dimension to the cpu in IBM's immensely popular Personal Computer. Except it's better.

It has the same outside dimensions. Same tooling holes, connectors and expansion ports. But we've made it expandable from 64K to 256K on the board and provided two serial ports and a parallel port — I/O's have to be added to the IBM PC with plug-in boards. The Faraday BIOS is designed to give maximum compatibility with IBM approved software, under MS DOS 1.1, 2.0, CP/M-86, and Qunix.

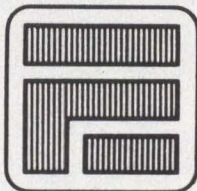

Faraday Electronics

1029 Corporation Way, Palo Alto, California 94303

The name:
**Faraday Electronics
Model 64. (FE 64)**
The Price: **As low as \$249
each in large OEM quantities.**
The evaluation price: **\$495 for
quantities less than 10.**

We have capacity to meet large orders; and know what we've got to do to service OEMs.

If you want to get aboard now (no pun intended.), you can get your evaluation units within a week by sending us a check or money order.

If you're an OEM, and want more information, give us a call at (415) 961-0600. We'll tell you more about the FE 64 and other Faraday products.

The Interpreter

IBM looks to third parties to provide graphics software for PC applications

By Frank Catalano

By choosing not to provide graphics software for personal computer applications, IBM Corp. has created new opportunities for third-party software vendors. Taking advantage of those opportunities, a number of companies with business graphics programs are going after the 550,000 to 600,000 IBM PCs that are expected to be in users' hands by the year-end, and more entrants are expected.

Despite suspicion among some software providers that IBM may eventually attempt to control the PC software market by altering the PC-DOS (an MS-DOS equivalent) operating system, an IBM spokesman contends that the company welcomes third parties with PC packages. "When we announced the PC, we featured the system's open architecture, around which companies could design their own product," he notes. "We continue to provide manuals and technical documentation to software companies and OEMs, and I see no change in that approach."

IBM sells more than 70 third-party PC software packages, ranging in applications from word processing to accounting, but has yet to endorse programs for dedicated graphics applications. However, IBM is evaluating graphics products from Graphic Software Inc., Aztek Inc. and Integrated Software Systems Corp., among others.

A huge market is at stake. Neil Kleinman, general manager of International Data Corp.'s Pacific Technology Center, a market analyst firm in Santa Monica, Calif., predicts that 2.5 million personal computers will be in use for graphics applications in 1986, representing a market for graphics software of more than 1 million packages worth about \$300 million. The IBM PC could account for as much as half of that.

Although some personal computers have been criticized for lacking the screen resolution required for graphics, the IBM PC has drawn praise. It is among the personal computers with "adequate resolutions," comments Bob Katzive, vice president of the computer group at Gnostic Concepts Inc., a market research firm in Menlo Park, Calif. He adds, "It would be foolish for a businessman not to take advantage of their graphics capabilities."

Suited to graphics

Equipped with a black-and-white monitor and a

graphics board, the IBM PC provides resolutions as high as 640 by 200 dots. A color monitor and the graphics board provide the PC with resolutions as high as 320 by 200 dots.

John Hemphill, a product analyst with Future Computing Inc., Richardson, Texas, states that those resolutions are sufficient for first-time computer-graphics users who previously either drew charts manually or depended on art departments. Such users, says Hemphill, include middle managers of large corporations and operators of small businesses. He explains they require graphics not for presentations to management, stockholders or customers—who might require high quality—but for presentations to peers and for decision support. "We're talking about a \$300 to \$500 software package running on a \$3,000 to \$5,000 computer," notes Hemphill. "Personal computers aren't going to give you the quality of graphics that you'd get from a dedicated graphics workstation or a host-based system."

The base price of the IBM PC with 64K bytes of memory and a monochrome display is less than \$3,000. The XT version with two hard disk drives and 128K bytes of memory sells for \$4,995. List price of a color monitor is \$680, the graphics board sells for \$244, and a graphics printer sells for \$395.

Hemphill admits that, compared to personal computers, host-based graphics systems and dedicated workstations provide users access to larger databases, interfaces to a greater variety of output devices, more flexibility in manipulating graphics and text and a wider choice of colors and character sets. Host-based systems and workstations sell for \$50,000 to \$200,000, however, and are intended primarily for MIS departments of large corporations and graphics specialists. "That's not the market our product is addressing," notes Kevin Bull, director of marketing for Aztek Inc., a pioneer provider of IBM-compatible PC graphics software. "We're going after a whole new group of first-time users."

Available products vary

Graphic Software Inc. Cambridge, Mass., became the first to provide a graphics program for IBM PC applications. Since announcing Chartman I in July 1982, the company has added four other programs to its product line. Targeting its software at a spectrum of

The Interpreter

users, including corporate executives and sales personnel, the company sells its Chartman series in ComputerLand stores. "We're going after users who analyze numbers as a normal part of their day-to-day jobs," explains Carey Bursten, national sales manager for Graphic Software. "What we're providing is a cheap way to make their analysis easier."

Price of Chartman I is \$325. It includes 20 line, bar, pie and text charts and is intended for use with a monochrome display. The software generates hard-copy graphics output using either the IBM PC, Epson America Inc.'s MX-80 or MX-100 printers or Hewlett-Packard Co.'s 7470 two-pen or 7220 eight-pen plotter.

Chartman II sells for \$380. It includes all the features of Chartman I but is intended for use with the IBM color monitor. That software supports graphics output with either Integral Data Systems Prism color printer or IBM XY 750 and XY 749 plotters. This year, Graphic Software announced an extended version of Chartman II that runs on IBM's PC XT. "Super" Chartman II sells for \$425; users can upgrade Chartman II packages for \$50.

Chartman III is a low-end version of Chartman I, and Chartman IV includes scatter graphs and GANTT charts not available on Chartman II. Chartman IV also provides users with statistical curve-fitting features and color bleeding. Chartman III sells for \$199; and Chartman IV sells for \$300.

All five packages allow users to input data either at a keyboard according to software-driven menus or by accessing data interchange format (DIF) files generated by packages such as VisiCalc or Lotus 1-2-3.

Although the Chartman series is Graphic Software's first and only offering, Aztek, which introduced IBM-compatible PCchart this year, has been in the graphics business for several years. A supplier of graphics hardware and software, Aztek's primary business focus is mainframe- and minicomputer-based slide-making systems.

Aztek hopes PCchart will expand the number of users producing graphics and, in turn, expand the market for its slide-making systems. "We hope to ship as many as 30,000 PCchart packages by the end of this year, and those shipments should drum up a lot of sales of our slide-making systems," claims Bull. "We may end up making more money on PCchart than on our larger systems."

Intended for use with a color monitor and requiring 256K bytes of memory, PCchart allows users to generate charts in 80 formats, using a combination of 64 colors and pattern fills. As with the Chartman series, users input the data they want graphically represented

by accessing VisiCalc DIF files. PCchart supports Epson printers and HP pen plotters. Users can output hard-copy slides via a modem or serial data link connected to an Aztek slide system. Aztek provides PCchart customers with listings of graphics-design service bureaus that use the company's slide-making product. Also available in ComputerLand stores, PCchart costs \$995.

Integrated Software Systems Corp. (ISSCO), San Diego, Calif., took a different approach in designing its PC graphics product. ISSCO's PC display driver package allows the PC to function as a terminal that can access the company's traditional line of host-based graphics software. Jeff Anderson, director of marketing, contends that ISSCO has an installed customer base of more than 140,000 host-based software packages and that many customers are installing IBM PCs. "Like most companies, we're very susceptible to market demand and, more specifically, to the market demand of our customer base," reports Anderson.

The PC display driver consists of one part that resides with the host and translates host-based graphics software into a form the PC can understand. Another part resides with the PC and allows the PC not only to emulate a terminal but also to store and recall graphics images. When the PC is in the terminal mode, users can generate and manipulate graphics. When it's in the standalone mode, users can review graphic images already generated. The package sells for \$245, and quantity discounts are available.

More entrants expected

Besides Graphic Software, Aztek and ISSCO, at least 10 other companies, including Centec Corp., Reston, Va., and Graphic Technology Product and Systems Corp., Rockville, Md., supply graphics products for the IBM PC. Bill Ablondi, a market analyst with Future Computing, says that, as sales of the IBM PC increase and as companies introduce plug-compatible systems, more graphics software will become available. The plug-compatibles will be a major force in the total IBM market. Companies such as Corona Data Systems, Compaq Computer Corp., Columbia Data Products Inc. and Eagle Computer Inc. have announced IBM plug-compatible systems. According to Future Computing estimates, IBM sold approximately 180,000 PCs last year and is expected to sell about 390,000 more by the end of this year. Combined sales of IBM and plug-compatible PCs will total 680,000 machines this year, Ablondi predicts, and 1.6 million machines in 1988.

"What that means to software vendors is that there will be a lot of sockets out there that their application packages can be played in," Ablondi concludes. □

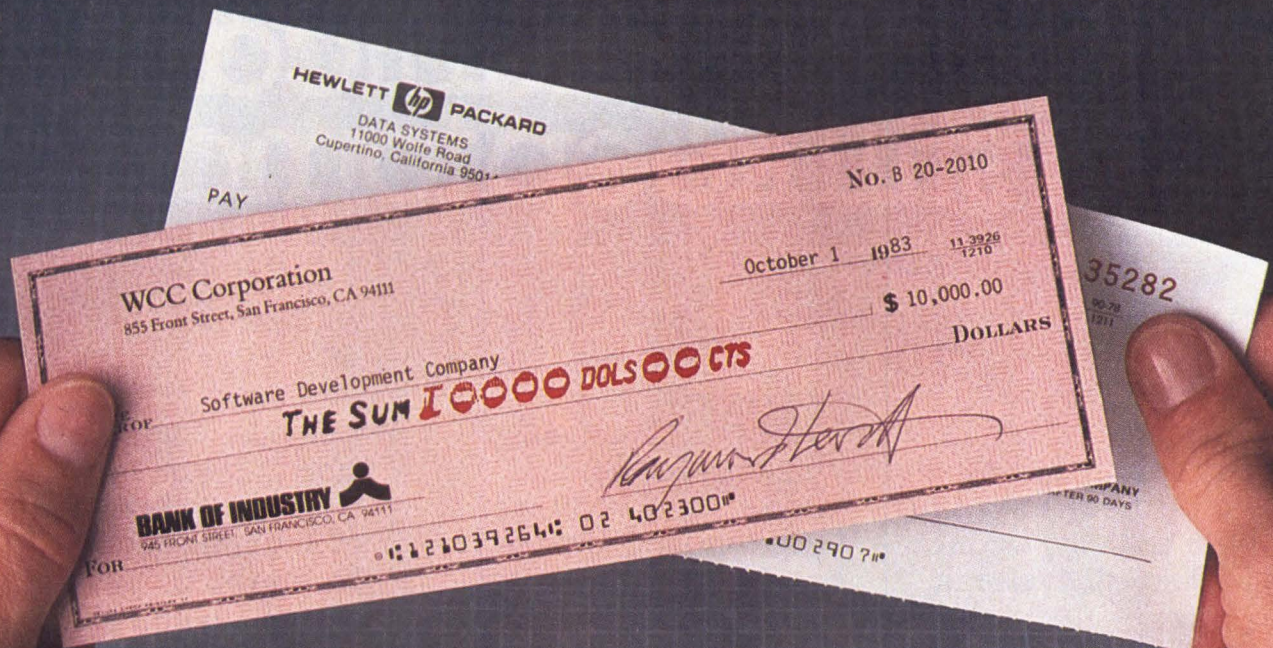

Writing HP software can be doubly rewarding.

Doubly rewarding, because every time Hewlett-Packard sells a new system with your software, you'll not only get a check from the customer, but one from HP as well!

As thanks for writing software for our systems, we'll give you a bonus of 30% of your software's sales price—up to 6% of the net HP system's price. That could mean \$3,000 on a \$50,000 system... or as much as \$30,000 on a \$500,000 system. And you'll get it *every time a new system is sold with your software.*

We won't tell you what kind of program to write. What industry to write it for. Or even specify the system. Our only restriction is that, to qualify for the bonus, your software must sell for at least \$10,000.

Of course, extra cash isn't the only incentive. To help you get started, we'll sell you a development computer at a 40% discount.

We'll also promote your software in HP catalogs, direct mail and advertisements. And you'll have the benefits of being associated with HP—one of the worldwide leaders in computing systems. A company whose products range from widely-used business computers, like the HP 3000, to one of the world's most advanced 32-bit computers, the HP 9000.

If you'd like to learn more, write to Hewlett-Packard, Attn Gwen Miller, Dept. 08173, 19447 Pruneridge Avenue, Cupertino, CA 95014. In Europe, write to Henk van Lammeren, Hewlett-Packard, Dept. 08173, P.O. Box 529, 1180 AM Amstelveen, The Netherlands.

We'll give you all the details on our HP Plus Software Supplier program. And all the reasons why it will be rewarding for *you* to develop software for HP.



CIRCLE NO. 57 ON INQUIRY CARD

U.S. List prices only.
BD-02301

How to put yourself into data communications And still keep tomorrow

First, focus in on our complete line of fully-compatible, fully-upgradeable data communications equipment—starting with our very economical small-systems gear.

Our entry-level statistical multiplexer, the Supermux® 380, can eliminate up to seven phone lines and seven modems—putting eight channels onto one line, with mixed speeds, mixed asynchronous protocols. The 380 is field expandable, so you can start with fewer channels and add as your needs grow. 380 capabilities include data

protection—eliminating data loss from line “hits”—as well as internal diagnostics and provision for downline loading of channel parameters.

Our 600-Series stat muxes are ideal for even larger communication requirements. The 632 handles up to 32 terminals over one or two phone lines, with

all the features of the 380, plus synchronous. And the 600 series provides port selection and contention, so you get more efficient use of your computer resources as well as saving on line costs.

We also offer a complete selection of competitively-priced modems, including limited-distance



Infotron data communications products for the smaller system: modems, statistical multiplexers field upgradeable to 32 channels, accepting mixed transmission speeds, mixed protocols, and synchronous, asynchronous, and bit-synchronous inputs.

today's picture. in focus.

models. For 380 and 600-Series stat muxes, we offer integral modems: you eliminate a lot of external cabling, space, and the cost of an extra power supply.

And everything we offer is designed for flexibility and growth—to meet your changing communications needs in micro, mini, and mainframe-based systems.

Then, consider Infotron's design philosophy of non-obsolescence.

We're a leading supplier of data communications equipment, and have been for over 15 years.

Our first line of support for what we sell is in the design itself—the capability for expansion, and for upgrading as the times change. We're a large-system supplier as well as a small-system supplier, and some of the world's largest public and private networks are using Infotron equipment well over ten years old—equipment upgraded in the field to today's performance levels.

Then, relax. You don't need to know all the answers. All you need to know is where to find them.

The toll-free number below will put you in

direct touch with us. For product information and literature. Or for answers to your specific questions. If you want equipment that meets your needs exactly, equipment designed to stay with you as you grow, backed by field service support from people known for reliable equipment and heads-up engineering, call us. We're here to help.

Infotron Systems Corporation, 9 North Olney Avenue, Cherry Hill Industrial Center, Cherry Hill, NJ 08003.

In NJ, call 609-424-9400.

800-257-8352

 **INFOTRON** SYSTEMS

CIRCLE NO. 58 ON INQUIRY CARD

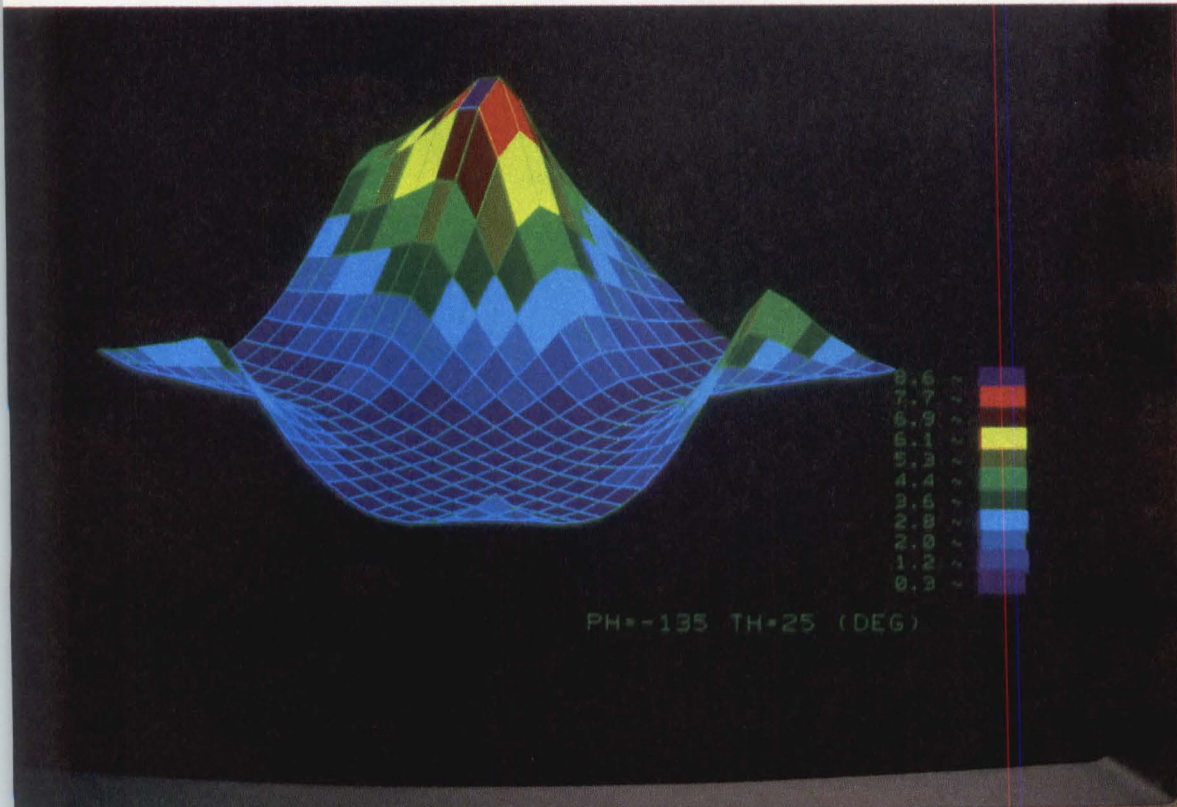

D-SCAN

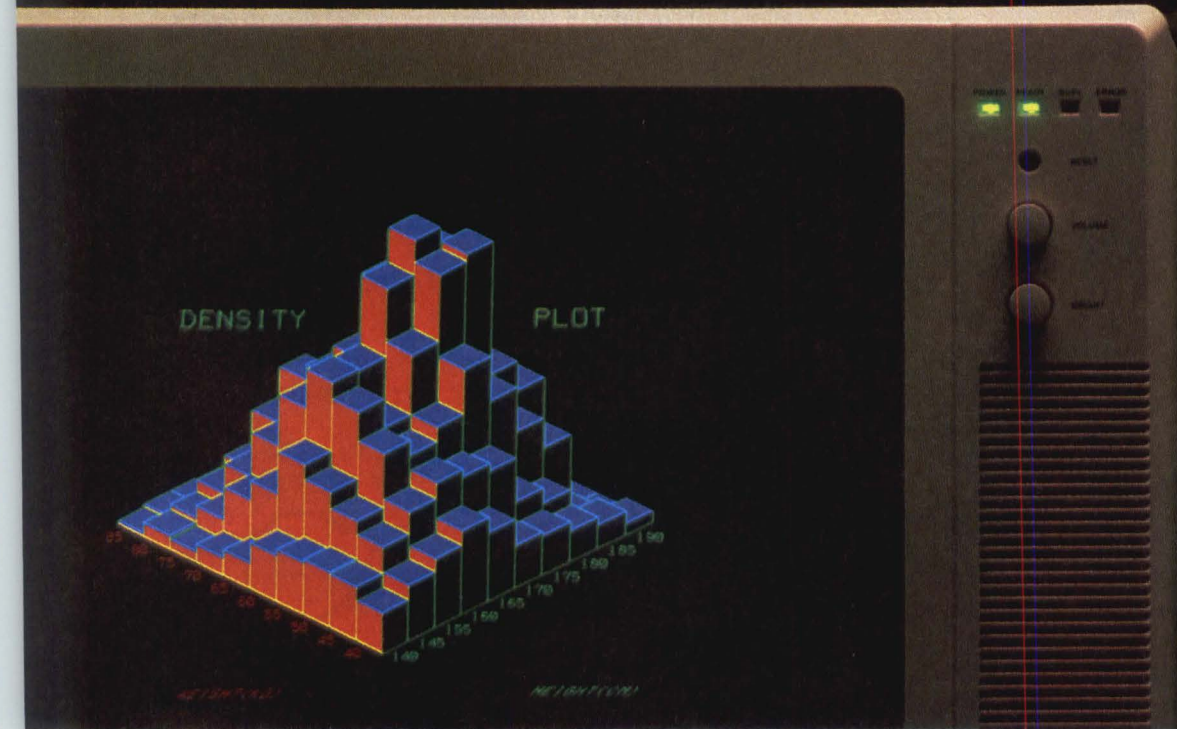

BEFORE WE MADE IT BIG IN PICTURES, WE WERE ALREADY A FAMILIAR FACE.



For over four decades, the Seiko name has been synonymous with precision and reliability.

That's what comes of making the world's most technologically gifted timepieces.

Using this vast experience in high-precision electronics, Seiko has also made a name for itself in computer peripherals. And sophisticated instrumentation.

It was only a matter of time before we got into pictures. And did we ever get into pictures.

Seiko Instruments now offers the industry's most impressive assortment of high-performance computer graphics products. From state-of-the-art color terminals to color hard copiers to precision data tablets.

Our full D-SCAN line can handle every size graphics application, from business to CAD/CAM.

The features in our D-SCAN terminals are exactly what you'd expect from a company obsessed with precision:

Crisp, high-resolution monitors. High-speed processing. And highly interactive displays.

We also offer a comprehensive line of digitizing graphics tablets. Totally compatible with our terminals, because they're made totally by Seiko.

Same is true of our output devices. Including the first intelligent copier equipped with advanced thermal transfer technology.

Moreover, all Seiko graphics products benefit from our many years of experience with precision manufacturing.

Which enables us to produce quality in quantity.

Which enables you, end users and OEMs alike, to get high-performance products with an added virtue. Value.

And the same people who make all the above support all the above—in the Seiko tradition.

With 14 offices throughout the U.S. Each with a thoroughly trained staff of sales, service and application professionals, all of whom work directly for Seiko Instruments. And you.

For more information, contact Seiko Instruments U.S.A., Inc., 1623 Buckeye Drive, Milpitas, CA 95035. Telephone 408-943-9100.

Because when it comes to graphics products, there's only one name to remember.

It's written all over our face.

SEIKO
INSTRUMENTS

© 1983 Seiko Instruments U.S.A., Inc., Graphics Devices & Systems Division.

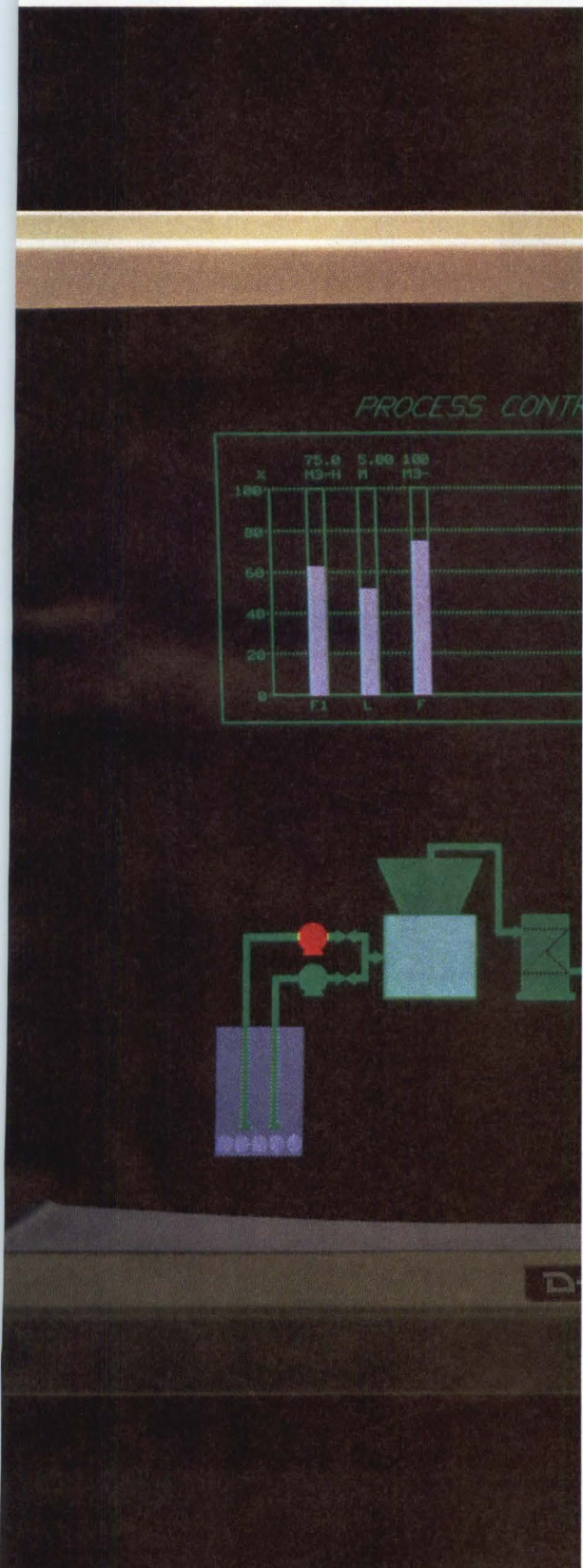

INTRODUCING



CONCEPT 1 ENCLOSURES

A NEW CONCEPT IN COMPUTER PERIPHERAL ENCLOSURES.

Concept 1 Enclosures is a versatile system of standardized molded enclosures for cost-effective packaging of systems and electronics. Concept 1 Enclosures have the field-proven performance and off-the-shelf availability to minimize engineering design time and manufacturing lead time. Plus, total versatility gives system integrators and OEM's the product flexibility to stay competitive at lower costs.

Functional Versatility—Concept 1 Enclosures accommodate 12" and 15" CRT sizes, have swivel/tilt bases, and are available with either standard or DIN keyboards. The 12" CRT enclosures can have either a 5¼" floppy drive or a 5¼" fixed or removable Winchester drive. Or two slim line ½-high drives.

Appearance Versatility—Concept 1 Enclosures are distinctive, with many color combinations and bezel configurations to "personalize" your system.

Packaging Versatility—Concept 1 Enclosures have a unique internal modular mounting system to hold various-sized control and function boards.

All Concept 1 Enclosures are molded in high-quality, OEM-grade plastic (Noryl® FN215 and Noryl® N190) and meet worldwide equipment and safety standards, including UL, CSE, VDE, BS, and IEC. Shielding for RFI and EMI also can be provided.

For special housing requirements, Data Packaging's 35 years of design, tooling, and high-volume manufacturing experience provides their customers with unique solutions to electronics housing problems.

CIRCLE NO. 59 ON INQUIRY CARD



DATA PACKAGING CORPORATION

205 Broadway, Cambridge, MA 02139 617/868-6200; TWX 710-320-0885

Please Come see us at Comdex/Fall Booth #2880.

Systems in Manufacturing

Exploring the use of computers in the factory

Distribution resource planning systems pick up where MRP systems leave off

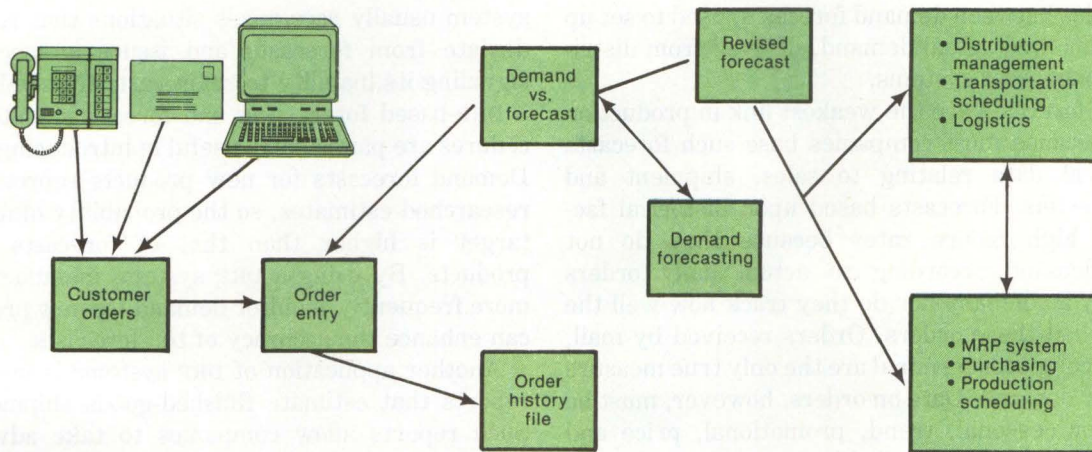

By James E. Grinnell
Distribution Management Systems Inc.

(Editor's note: Distribution Management Systems (DMS) Inc., Lexington, Mass., is an application software and systems company specializing in the development and installation of minicomputer-based distribution and warehouse-management systems. The company bases its two application packages—the DMS 1000 distribution system and the DMS 1500 warehouse-management system—on Digital Equipment Corp. VAX computers. DMS is an authorized DEC distributor and sells its software packages separately or bundled with hardware. Both the DMS-1000 and the DMS 1500 system can interface with mainframe computers and support remote and hand-held terminals, bar-code readers and labelers.)

After using material-requirement planning (MRP) systems with some success, manufacturers are now turning their attention to distribution-management systems that facilitate not only the distribution but also the warehousing and transportation of finished goods. Although MRP and distribution-management systems apply to different aspects of an organization, both can be implemented as one on-line system called a distribution-resource planning (DRP) system. A DRP system closes the loop between manufacturing and distribution, providing an accurate, up-to-date database on which to base corporate decisions.

Closing the loop between on-line order entry and demand forecasting, a distribution-resource planning system (DRP) updates management on discrepancies between demand forecasts, used to set up material-requirement planning (MRP) systems, and actual demand, derived from distribution-management systems. The DRP system provides an accurate, up-to-date database on which to base corporate decisions.

MRP systems help managers plan production scheduling, manufacturing-resource allocation, raw-material and component-inventory management and raw-material and component purchasing. To facilitate planning, MRP systems require various data inputs ranging from simple to complex. Those inputs include:

- identifying products that can be produced most economically at each production facility or at different stations in each facility,
- the lead times required at each facility for changing from producing one product to producing another,
- the most cost-effective production quantities required for each product at each facility,
- accurate, time-phased forecasts of demand for each product.

Distribution-management systems, on the other hand, assist management in post-production functions, including order processing, customer service, finished-goods inventory management, billing, accounts receivable and payable and general ledger. On-line systems also contribute to the operation of warehouses, offer

Systems in Manufacturing

control interfaces to automated materials-handling systems and provide a cost-effective means to transport resources.

The primary benefit of integrating distribution-management and MRP systems centers on closing the loop between on-line order entry and demand forecasting. Closing the loop keeps management updated on discrepancies between demand forecasts, used to set up MRP systems, and actual demand, derived from distribution-management systems.

Demand forecasts are the weakest link in production planning because most companies base such forecasts on historical data relating to sales, shipment and inventory levels. Forecasts based upon historical factors have high failure rates because they do not measure demand according to actual daily orders received by a company nor do they track how well the company filled those orders. Orders received by mail, phone or a computer terminal are the only true measure of customer demand. Data on orders, however, must be adjusted for seasonal, trend, promotional, price and other factors to provide a reliable database on which to build demand forecasts, which play an important role in MRP decisions.

Advances in on-line systems technology and software facilitate recording orders in real time. Companies that install DRP systems that couple on-line order entry with dynamic demand-forecasting software systems can monitor and adjust their demand forecasts and, as a result, make them more accurate.

A successful DRP system has three key elements. First, an on-line order-entry process captures detailed data on all orders received by a company at each order-entry point. Second a computer-based demand-forecasting system uses the data generated by the order-entry system to adjust forecasts based on historical demand. The system produces a variety of forecasts that take into account changing inputs and conditions, such as new marketing and promotional efforts relating to a product. Lastly, a series of programs compares forecasted demand with actual demand. The programs quickly identify all discrepancies between forecast and actual demand and compile a historical record of those discrepancies. This element completes the order-entry/demand-forecasting loop and provides the dynamic demand data required to restructure production, raw-material inventories and other manufacturing elements to meet changing market conditions efficiently.

A system typically generates forecast-vs.-actual demand comparisons in the form of exception notices. At the end of each order-recording period, the DRP

system implements regression-analysis procedures to compare forecast performance. Unusually high or low discrepancies are easily identified and printed in report form. Reports can be transmitted to various levels of management for reforecasting applications, or the system can automatically revise forecasts for future demand periods. In automatic reforecasting, a DRP system usually recognizes situations that consistently deviate from forecasts and issues a special report signaling its inability to reforecast effectively.

DRP-based forecasting and forecast-monitoring procedures are particularly useful in introducing products. Demand forecasts for new products represent highly researched estimates, so the probability of missing the target is higher than that of forecasts for older products. By using a DRP system, manufacturers can more frequently monitor demand for new products and can enhance the accuracy of the forecasts.

Another application of DRP systems is in organizing reports that estimate finished-goods shipment dates. Such reports allow companies to take advantage of weight and volume price discounts when scheduling truck, freight and air shipments. □

James E. Grinnell is president of Distribution Management Systems Inc., Lexington, Mass.

NEXT MONTH IN MMS

The December issue of Mini-Micro Systems, the annual technology review, is MMS's encyclopedic resource for its unique readership of value-added OEMs and users, and resellers. It consists of feature articles about various technologies, with market and product data in graphs, charts and tables.

Each topic covers the evolution of the technology and its present significance to MMS readers, including the current state-of-the-technology and state-of-the-market. The issue will address the trends within the technology, plus short- and long-term product and market projections.

Topics covered will include:

- **Databases:** models, interfaces between program and user, distributed databases and applications
- **Office automation:** integrated OA systems, dedicated function systems and software
- **Microprocessors:** architecture, fabrication, simulation and packaging
- **Artificial intelligence:** natural language translation, expert systems and vision systems
- **Co-processors:** communications, local area networks and floating point arithmetic

The terminal that's a perfect fit anywhere in your company.

Qume's new QVT 108™ terminal has the power and flexibility to handle everything from routine order entry to the most demanding management-level applications. It outperforms competitive terminals, with sophisticated features like 22 user-programmable functions, 12 editing functions, a user-defeatable 25th status line, a menu set-up mode, and two full pages of screen memory.

The QVT 108 is easy to use, with complete emulation of Televideo's 925*, 920*, or 912* terminals at the stroke of a key. And your staff will love its superior ergonomics. The QVT 108 has a detached,

low-profile keyboard, height-adjustable to different handrest positions. A tilt-swivel screen in green or amber, with an optional 14-inch display for even better readability. Plus many other features to keep people comfortable and productive.

Best of all, the QVT 108 is priced to fit just as comfortably within your budget. Talk to your Qume sales office about the terminal that's ideal for everyone in your company. Or write Qume Corporation, 2350 Qume Drive, San Jose, CA 95131.

Qume QVT terminals.
Your best investment in productivity.

Qume®
A Subsidiary of ITT

QUME CORPORATION
HEADQUARTERS
2350 Qume Drive, San Jose, CA 95131

CALIFORNIA
San Jose (408) 942-4111
Culver City (213) 410-1458
Santa Ana (714) 957-4040

COLORADO
Aurora (303) 752-3000

ILLINOIS
Hoffman Estates (312) 490-9320

OHIO
Dayton (513) 439-0469

TEXAS
Irving (214) 659-0745

NEW JERSEY
Edison (201) 225-5005

MASSACHUSETTS
Bedford (617) 275-3200

GEORGIA
Decatur (404) 284-8500

GERMANY
Düsseldorf
PH 211743016

ENGLAND
Reading, Berkshire
PH: 734-584-646

FRANCE
Boulogne
PH: (1) 6082334

CANADA
Quebec
PH: (514) 695-3837

See us at COMDEX Booth No. 1636.

CIRCLE NO. 60 ON INQUIRY CARD

OEM's Unlock the ASCII-3270 market.

Now OEM's can profit from the expanding ASCII to 3270 market.

Our products give your ASCII peripherals a valuable new capability: access to IBM 3270 environments. While margins on async equipment continue to shrink, the 3270 market is growing at upwards of \$200 million per year. So talk to Peripheral Technology—and get your share.

SCAT systems make OEM equipment IBM compatible.

PTI manufactures a full line of protocol converters and terminal controllers for either stand-alone or direct product integration. Used in conjunction with OEM ASCII peripherals or computer device ports, SCAT lets OEM's offer features and functions not available from IBM or other plug compatible manufacturers. OEM's can now give users the economy of dial-up instead of expensive dedicated phone lines between remote and host locations. The elimination of coaxial cables. Support for multiple hosts, both

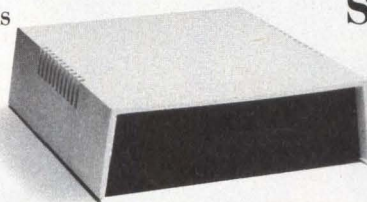

sync and async. PTI will provide software support for non-IBM protocols at your request.

SCAT 2 is more than a "black box" solution.

The versatile SCAT 2 is available for repackaging, private label or may be integrated directly into existing ASCII equipment. PTI will provide engineering and technical support for OEM product integration. SCAT 2 is available in one host or multi-host configurations and is expandable from one to twenty-five ports. SCAT 2 is a very cost effective BSC/SNA controller that satisfies all 3270 communications requirements.

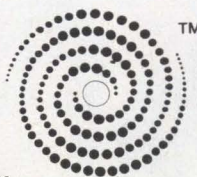

Peripheral Technology, Inc

See us at COMDEX #W-267

SCAT 1 means value-added versatility.

This compact, reliable 3270 BSC/SNA emulation board can easily be installed in most ASCII terminals or peripheral devices. Designed as a general purpose programmable communications controller, SCAT 1 is available with RS-232 interfaces, compatible with dial-up or dedicated links and transmission speeds up to 9600 bps-full or half duplex. Operation is menu-driven, and two levels of password security are provided.

1-800-822-2208

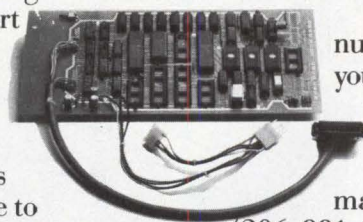

That's the number to call when you're ready to unlock the profit potential of the 3270 BSC/SNA marketplace (206-881-6691 in Washington State). We know protocol conversion from the boards up, and offer fast delivery backed by nationwide service and support. Peripheral Technology, Inc., 14784 N.E. 95th, Redmond, WA 98052.

SCAT is a registered trademark of Peripheral Technology Inc.

Systems in Manufacturing

Star targets array-processor system for research applications

A new 32-bit microcomputer based on array-processor technology is available from Star Technology Inc., Portland, Ore. Called the ST-100, the system is intended for research applications that demand high-speed number-crunching capabilities. The ST-100 is targeted for sales to OEMs and large end users in seismic exploration, image processing and signal processing.

The ST-100 incorporates two parallel Motorola 68000 microprocessors into one master control processor. Three CPU boards, each of which includes Motorola 10K-byte gate arrays, handle storage, arithmetic and input/output. Star vice president of research and development Robert Hausman estimates the ST-100's maximum processing speed at 100 million floating-point operations per second (MFLOPS). In terms of processing speed, he notes, the ST-100 is approximately 100 times more powerful than IBM Corp.'s 4300 computer and is about 10,000 times more powerful than a typical personal computer.

Designed to run with a general-purpose host computer, the ST-100 easily interfaces to such systems as Digital Equipment Corp.'s VAX-11/780, Perkin-Elmer Corp.'s 32/40 and 32/50 and IBM's 4300 series and 3081. It is addressable via FORTRAN subroutines that can be executed on the host. Data can be transferred directly from the host's main memory or from mass-storage devices. The I/O transfer rate is 12.5M bytes per second, and the DMA channel transfer rate is 100M bytes per second.

Star sees the primary market for the ST-100 as fuel suppliers. These

users need computers that can quickly process large amounts of seismic data from oil and gas exploration. In late July, Star shipped its first system to GEO-X, a Canadian petroleum exploration company. GEO-X will write its own application software for the ST-100 and will configure the system to run with an IBM 4300 series computer.

Star is also targeting the ST-100 for sales to suppliers of image-processing systems for cartology and medicine. The third target market—signal-processing—primarily comprises military suppliers of sonar and radar analysis systems.

While Hausman claims that, although typical turnaround time for the design of a new computer system usually exceeds four years,

Star engineers designed the ST-100 in less than 20 months. He attributes the short design cycle to the company's use of custom gate-array, computer-aided design (CAD) and simulation technologies. A technology-exchange agreement between Star and Control Data Corp. (CDC) enabled the ST-100 to be designed on a CDC CAD system. The operating software for the system was written using an ST-100 simulator during hardware design.

Selling for \$250,000, a basic ST-100 system includes 500K bytes of main memory and 48K bytes of cache memory; a host interface; and operating, development and maintenance software. Star also provides installation and maintenance support.

Star Technology's ST-100 microcomputer is targeted for number-crunching applications in the seismic-research, image-processing and signal-processing markets. It is compatible with DEC VAX 11/780, Perkin-Elmer 32/40 and 32/50 and IBM 4300 and 3081 computers.

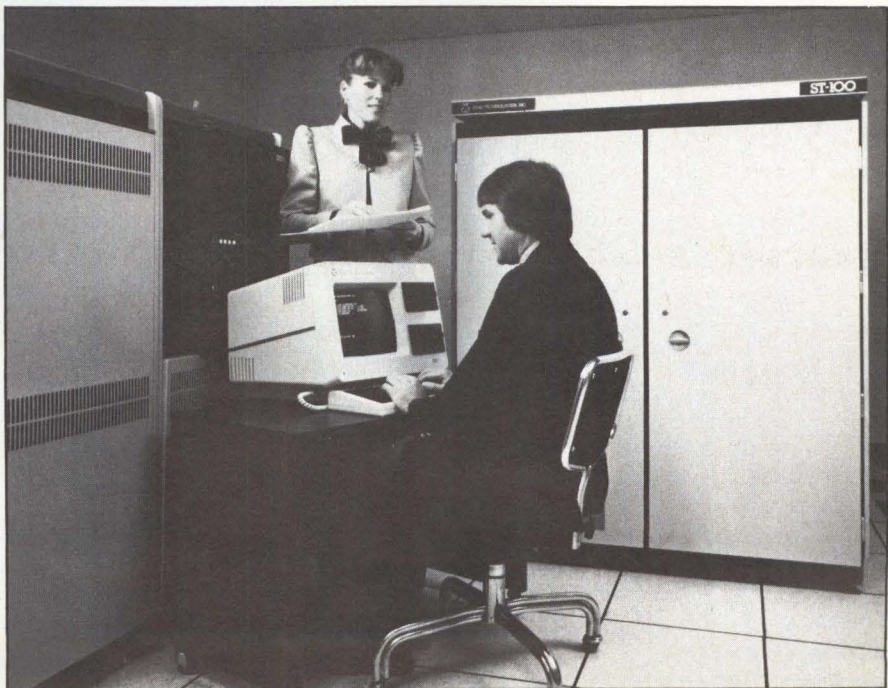

How Cromemco makes its System One doubly valuable.

The Cromemco System One gives you all the versatility and performance you need to tackle the most complex computing problems.

Dual microprocessors give you a 68000-based machine

that also runs Z-80 programs. The 68000, with its 32-bit architecture, gives you superior processor capabilities and is supported by an extensive line of high level software. The Z-80A lets you

use the largest base of existing application software available. Now you can get the best of both worlds in one integrated, expandable, low-cost system.

It's available with either

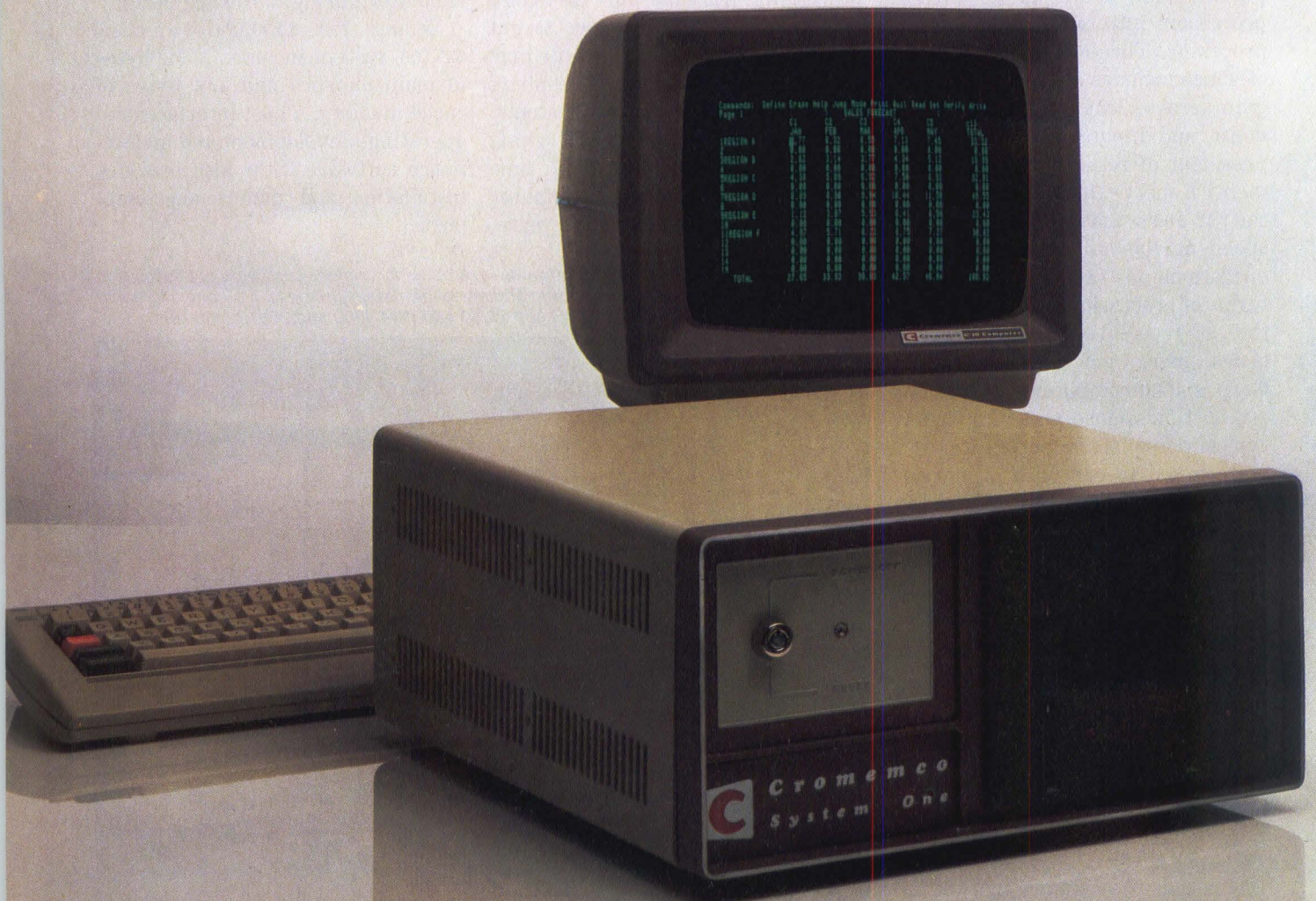

a full 21 Mbyte hard disk and a floppy disk or with two floppy disk drives. That puts enough processing power at your fingertips to tackle the tough jobs. But with Cromemco, you get more.

Software is where Cromemco's System One really shines. The CROMIX* operating system, inspired by the UNIX* system, runs on both the 68000 and Z-80A and provides a similar user interface, improved file security, and record level locking. CROMIX is so flexible it lets you run your CP/M* based programs, too.

We offer a full complement of high level languages as well, including FORTRAN, PASCAL, COBOL, C, BASIC, and ASSEMBLER.

The System One is a desktop computer and can support one user or multiple users. It is one of Cromemco's full range of expandable computer systems.

Since all Cromemco systems are based upon the standard IEEE-696 bus, you can configure and expand them with our broad line of board level products. To enhance throughput, our systems can use our C-10 personal com-

puter as an intelligent terminal.

Whenever your applications require reliable computing for business or engineering use, Cromemco gets the job done.

Call us today for our new Systems Catalog or for our nearest dealer or distributor. Or write Cromemco, Inc., 280 Bernardo Avenue, P.O. Box 7400, Mountain View, CA 94039. Tel. (415) 964-7400. In Europe: Cromemco A/S, Vesterbrogade 1C, 1620 Copenhagen, Denmark.

Cromemco



*CROMIX is a registered trademark of Cromemco, Inc.
UNIX is a trademark of Bell Laboratories
CP/M is a registered trademark of Digital Research

CIRCLE NO. 62 ON INQUIRY CARD

The New FUJITSU BAND PRINTER

Series When You Know How They're Built,
You'll Choose Fujitsu.

That's because the entire Fujitsu Band Printer Series is built to perform, built to fit and built to last. You'll get crisp, high-quality printing when and where you need it.

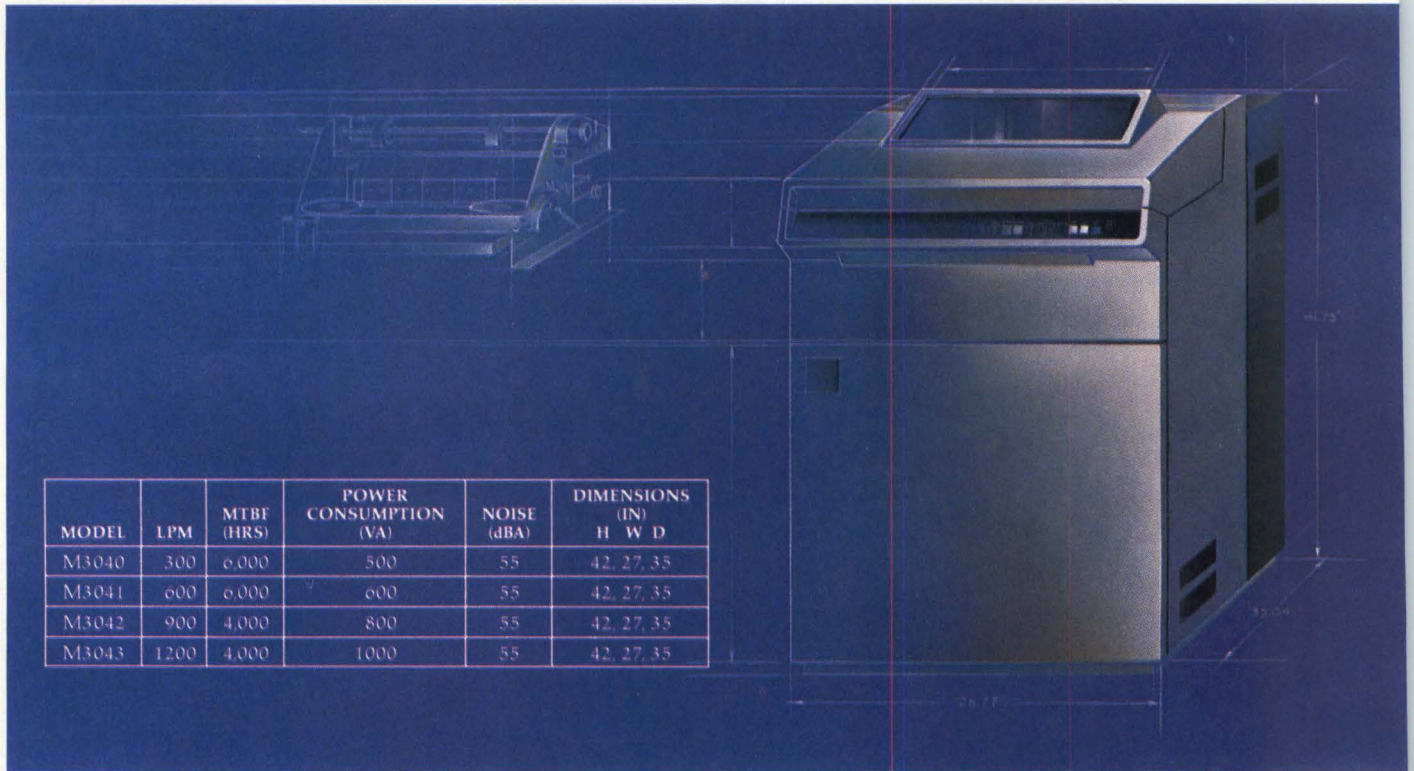

MODEL	LPM	MTBF (HRS)	POWER CONSUMPTION (VA)	NOISE (dBA)	DIMENSIONS (IN) H W D
M3040	300	6,000	500	55	42, 27, 35
M3041	600	6,000	600	55	42, 27, 35
M3042	900	4,000	800	55	42, 27, 35
M3043	1200	4,000	1000	55	42, 27, 35



High reliability is also built into the Fujitsu printer design. You'll find 6000 hours of Mean Time Before Failure (MTBF) and exceptionally high parts commonality. Service requirements are infrequent and, if needed, are simple to perform.

Fujitsu's band printers are surprisingly compact. They're designed to fit into the smallest space, and at 55 decibels, they're peacefully quiet.

The Fujitsu Band Printer Series is available in speeds ranging from 300 LPM to 1200 LPM in the M3040, M3041, M3042 and M3043 models. Each printer sets a new standard in price/performance. For more information, contact Fujitsu at 3075 Oakmead Village Drive, Santa Clara, CA 95051, or give us a call at (408) 988-8100.



CIRCLE NO. 63 ON INQUIRY CARD

See us at
Booth No. 1736
COMDEX™
Fall '83

November 28-December 2, 1983
Las Vegas Convention Center,
Las Vegas, Nevada

Systems in Manufacturing

Intelligent controller is alternative to dedicated industrial terminals

A portable intelligent controller from Analogic Corp., Danvers, Mass., saves industrial users the cost of dedicating a single terminal to each computer-controlled machine in their factories. Called the Linker 100, the unit also helps ensure the security of programs controlling the machines.

The Linker 100 weighs 2 pounds. It includes an 8-bit Zilog z8 microprocessor, a 2-line-by-40-character liquid-crystal display and a 48-character software-definable keypad. Analogic targets the Linker for sales to OEMs and sophisticated end users who can tailor the unit with application-specific software or incorporate it into machines or instruments bearing private labels.

"The uniqueness of the Linker is that it's small and portable," explains Douglas J. Tuttle, product manager of Analogic's Industrial Technology Group. "Conceivably, a user could plug it into his office, write a program and then take it down to the factory floor and plug it into a machine." Programs written on the unit can be down-loaded to a dumb machine or instrument controller via an RS232 serial port. Once programs are down-loaded, the Linker can be unplugged and used to reprogram another machine.

"There are two trends in the industry that we're trying to tap into," comments Tuttle. "A lot of machines don't need a dedicated terminal because the times that machine programs need to be altered are few and far between. The other trend is that users are concerned about the security of their programs. Once the Linker is



Analogic's Linker 100 intelligent controller weighs 2 pounds and includes a 2-line-by-40-character liquid-crystal display and a 48-character software-definable keypad.

unplugged from a machine, no one can access and change the program running that machine."

A primary application that Tuttle envisions for the Linker is as a programming device for machines that run batch operations. In a paint-mixing application, for instance, machinery might be programmed to mix one color of paint for one hour and another color for the next hour. The Linker would be used to reprogram the mixing apparatus each time a new paint batch is required.

A second application of the Linker is as a ramp-temperature controller. The Linker includes a real-time clock that allows a user to program different events to occur over time. To control the temperature in an oven, for example, a user could program the device to execute a command that raises the oven

temperature 5 degrees Fahrenheit every 10 minutes. Once the temperature reaches 100 degrees Fahrenheit, the Linker could execute commands that would maintain that temperature for 20 minutes and then would allow the oven to slowly cool to the starting temperature.

The Linker's display and keypad both include proprietary microprocessors allowing for concurrent overlapped processing. With that feature, the display can be used to monitor the machine's operation while a user reprograms that machine using the keypad. The z8 microprocessor, meanwhile, could supervise both peripherals. The unit includes 2K bytes of battery-protected RAM, 8K bytes of ROM and 4K bytes of PROM. Programs can be written on the Linker in BASIC or machine code. Price of the system is \$400 in 100-unit quantities.



The design solution: Winchester

Save your customers time, space, and money with 1/4" data cartridges.

When 3M invented the 1/4" data cartridge, they designed it to be fast, dependable, small in size, and big in capacity — up to 67 megabytes today, with more in store for the future. No wonder more and more systems

designers are finding it the perfect choice for backing up Winchester drives. 45 megabytes of data can be transferred from disk to tape in under nine minutes — with no time lost for media changes. One cartridge does it all! It would take a stack of 38 eight-inch floppies* to hold the same amount of data. The cartridge

is small enough to fit in a coat pocket — and rugged enough to be transported that way, too.

New rules of standardization.

Industry standards are now being formulated which will improve interchangeability of 1/4" recorded data cartridges across most major manufacturers' 1/4" drive systems.

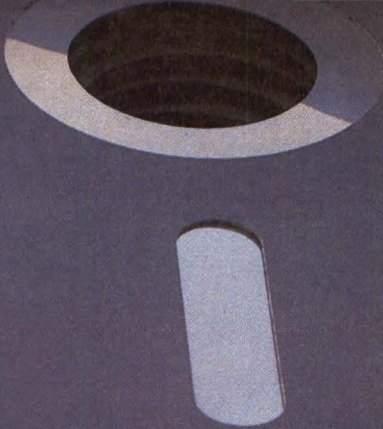

back-up that eliminates stack-up.

This means concerns about compatibility are diminishing.

The logical choice.

The 1/4" data cartridge is the logical choice for designers specifying back-up systems for Winchester drives. It's small, reliable, easy to handle and transport, and has a very low cost per megabyte.

These high capacity cartridges are useful for archival storage and program loading, too. So don't wait, give your customers the future. Put this innovative technology to work in the next computer system you design. Data cartridge drives are available from over 30 manufacturers throughout the world.

For more information:

For more information on how 3M 1/4" data cartridges can save your customers time, space, and money, write to Chris Binner, National Sales Manager — OEM Market, Data Recording Products Division, Building 223-5N, 3M Center, St. Paul, MN 55144.

*Double sided/double density 1024 format 8" diskettes.

3M hears you...

3M

Introducing The ONYX Office.™



The new ONYX Office. It makes everyone in the company think they have their own personal computer.

And with the ONYX Office, even small and medium-sized businesses can enjoy the power and versatility of the UNIX Operating system.

With none of the complexity.

And new, brilliantly designed ONYX computers and terminals put an end to the problems that go with personal computers in the multi-user office: availability and high cost per terminal. The cost of an ONYX system for eleven users? Under \$2000 per user. Much less than eleven personal computers. With remarkable ONYX Office versatility built in. Including:

ONword™ The ONYX Office Word Processor.

A Wang™-like word processor with some even more sophisticated functions, including split windows. Its user menu, and a myriad of screen editing features provide tremendous flexibility in formatting, unmatched by any other system.

ONbase™ the ONYX Office Database Management System.

A fast, powerful relational database system that allows the novice to use it as easily as a professional

The first integrated office information package for the UNIX™ operating system.

programmer. Applications can be developed, even by the end-user with ONbase non-procedural tools.

ONmail™ the ONYX Office Electronic Mail Program.

ONmail creates, sends, and receives mail, supporting hard copy devices and terminals. It uses mailing lists, storing and retrieving documents. The system notes mail received in the user's inbox.

Summarizes what has been received, what has been read, what requires priority. Provides for certified, confidential and urgent mail.

ONcalc™ the ONYX Office Electronic Spreadsheet Program.

Now anyone can now do forecasting easily using these unique ONcalc features: optional data display in bargraph format, financial and statistical functions, internal rate of return; least squares, present value, standard deviation, and future value. Separate spreadsheets can be merged.

Using the power of the UNIX operating system, files and data can be moved between applications, combining functions of ONword, ONcalc, ONbase, and ONmail.

ONYX Office CONNEXION™

A run-time shell, providing a superfriendly menu and an innovative link between applications. For the software developer and systems integrator the development version of CONNEXION ties vertical applications into the ONYX office to make a complete package.

The Onyx Office, a retail value of \$5,000, is now bundled with every ONYX-UNIX system we ship.

Make the Connection

ONYX-UNIX

OPERATING SYSTEM

Onyx Systems, Inc., 25 E. Trimble Road, San Jose, CA 95131
In Calif. (408) 946-6330, outside (800) 538-6813

UNIX is a trademark of Bell Laboratories, Inc. Wang is a trademark of Wang Laboratories, Inc. ONYX Office, ONbase, ONcalc, ONmail, ONword, and Connexion are trademarks of Onyx Systems, Inc.

CIRCLE NO. 64 ON INQUIRY CARD

FEATURE HIGHLIGHTS

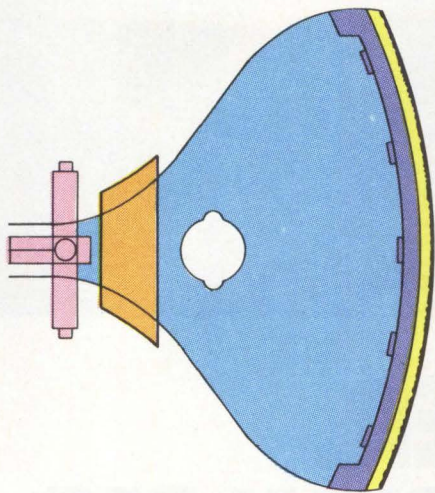

TERMINALS: Low-cost alphanumeric display terminals are no longer "dumb" devices lacking local intelligence and editing capability. Many low-cost terminals now boast impressive performance in terms of data-transmission rates, emulation, editing capabilities and graphics functions, due to advances in microprocessor technology. Turn to p. 141 to consult MMS's survey of 24 terminal manufacturers and their products. . . **Autoconvergence** is the ability to adjust convergence automatically to an original specification anytime during an application. Tektronix Inc.'s model 4115 color terminal, profiled on p. 173 offers a high-resolution display with autoconvergence to provide sharp, true colors and precise data representation for such high-density graphics applications as computer-aided design and mapping. . . The market for digital speech-processing products is projected to increase from \$26 million in 1982 to more than \$780 million in 1987. A key concern of speech product vendors and system integrators is how to introduce and implement voice technology for end users. See p. 183 for information on a planned threestage approach for **implementing voice-processing strategies**. . . Megatek Corp.'s Whizzard 1650 color **graphics engineering terminal** is a low-cost, versatile workstation with alphanumeric capabilities and a built-in line analyzer. Check p. 201 to see if this device meets your design needs.

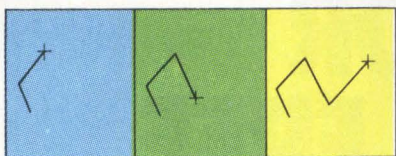

GRAPHIC WORKSTATION: Interested in fast, near-photo-quality resolution that won't tie up the processing power of your 16-bit CPU? Check p. 215 to see how Forward Technology Corp. configured its FT-500 Gateway engineering workstation. It features a specialized graphics board with key raster-scan operations hard-wired into its graphics processor.

COMDEX™ Fall '83

CONFERENCE PREVIEW: Software will hold the limelight when Comdex/Fall '83 convenes in Las Vegas, Nev., Nov. 28 through Dec. 2. Many of the conference's 52 professional sessions will focus on key operating system (OS) trends, integrated microcomputer software packages, major and emerging languages, developments in local area networks (LANs), database software and software interfaces for microcomputer-to-minicomputer or microcomputer-to-mainframe connections. For more highlights, turn to p. 229.

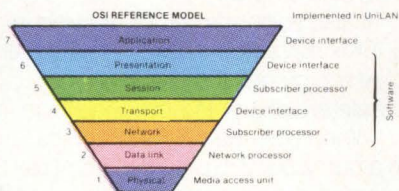

COMMUNICATIONS: Applitek Corp.'s UniLAN uses the UniLINK access method to combine the advantages of CSMA/CD and token passing on one 10M-bit-per-second network. UniLAN uses either broadband or baseband coaxial cable or fiber-optic cable and has modular software. For more information, see p. 241.

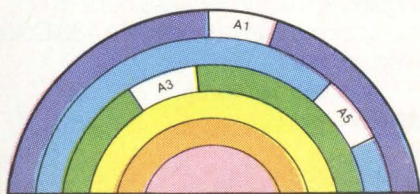

SOFTWARE: At the ancient age of 10, UNIX is seen by some as too slow and awkward for efficient microcomputer processing. Several microcomputer manufacturers have introduced enhanced systems that retain UNIX's strongest features while bringing it more into line with the new higher performance hardware. Turn to p. 255 for one company's solution.

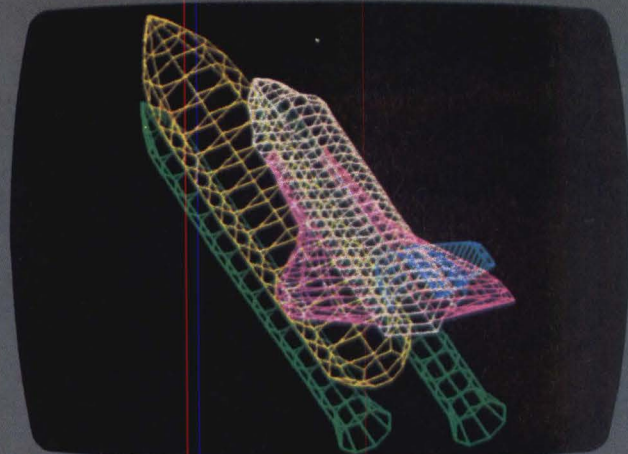
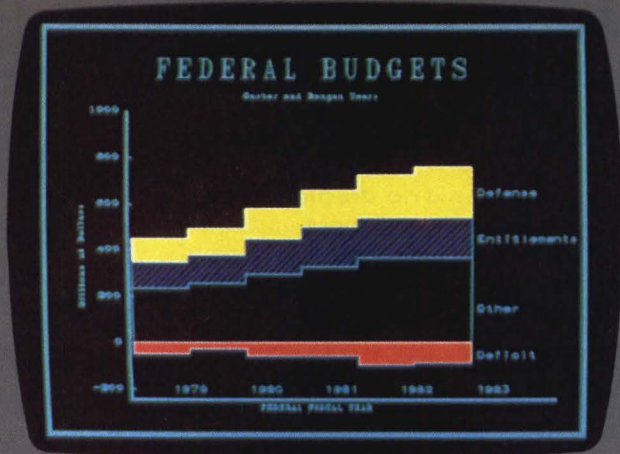

RED HOT OFFER. GET THE NEW ENVISION 215 COLOR GRAPHICS TERMINAL AND GET COLOR ALPHANUMERICS FREE.

You're in for a nice surprise. Because when you buy our new Envision 215 Color, Text/Graphics terminal you'll also get color alphanumerics. Free.

WHAT YOU DON'T KNOW

What you might not know is that our new 215 is a low priced terminal with two distinct and very usable talents.

It's an intelligent color graphics terminal which also happens to be a high quality color alphanumerics terminal. But this didn't happen by chance.

We designed both capabilities into the same terminal for one very important reason. You. And quite frankly it makes a great deal of sense because now you don't have to buy two terminals when you want to create color graphics and color alphanumerics. Our new 215 does both exceedingly well.

DID WE GIVE OUR 215 TOO MUCH GRAPHICS CAPABILITY?

Before answering, you should know our 215 is the ideal color graphics terminal for an amazingly large number of applications.

In business, scientific and engineering our new 215 tackles complex color graphics with aplomb.

There's actually a good chance you'll run out of ways to use our 215 in your particular job long before it runs out of color graphics capability.

That's because it's supported by ISSCO, Megatek, Precision Visuals and SAS Institute graphics software.

We also made it compatible with the Tektronix® 4014 which means our 215 is supported by a host of other graphics software packages.

SHARP. PUNCHY. VIVID. COLOR GRAPHICS

You don't have to be an art major to create striking graphics with our 215. You can create vivid 8-color graphics from a palette of 64 colors.

The vivid part comes from the fact that our 215 has a high resolution 640x409 display.

It also supports vector drawing in a 16K x 16K virtual address space. All of which means the graphics you create are sharp. Punchy. And vivid.

When you need color graphics in a hurry, our 215 provides complex polygon drawing, vector drawing and fill primitives as standards. And screen copies are easy because our 215 is compatible with our Envision 430 Color VectorPrinter™

And there's more!

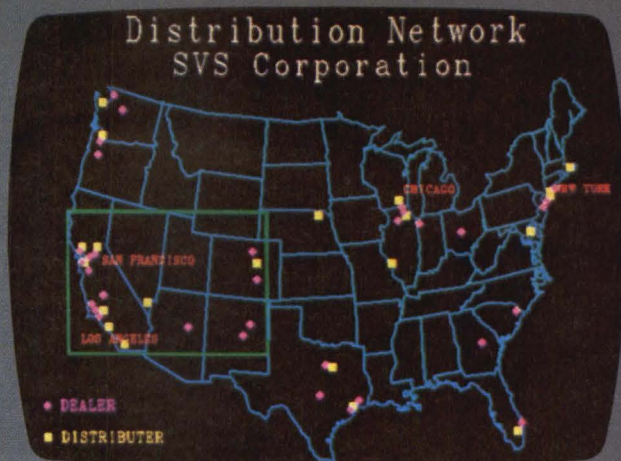
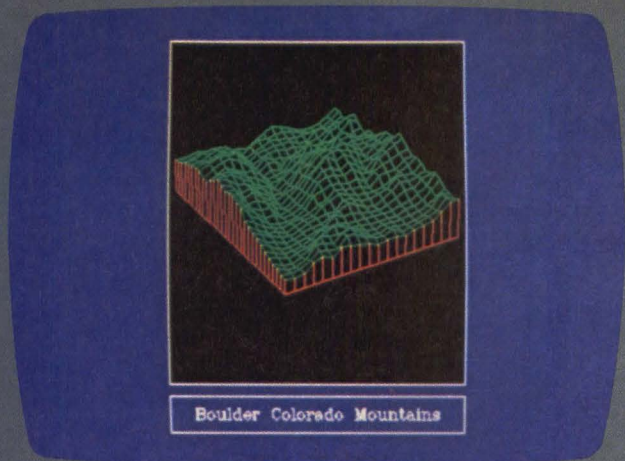

Five different line types are available for vector drawing. Two character fonts are provided. And both fonts can be drawn at four different angles in 16 different sizes.

If all of that's still not enough, don't forget our 215 is also a very versatile color alphanumeric terminal.

INDEPENDENT COLOR ALPHANUMERICS MAKE OUR NEW 215 DOUBLY VALUABLE

We gave our 215 independent memories for graphics and alphanumeric so you can display them separately. Or together.

We also made it VT-100® compatible with programmable soft keys and menu configuration.

You can make characters double width and double height and display 132 column information for maximum viewing.

You can also mix foreground and background colors to highlight different types of data.

A ONE YEAR WARRANTY ON ALL OUR COLOR TERMINALS

When you buy our new 215 we won't forget you. Matter of fact, you'll probably want to know more about our entire family of color graphics terminals. For example, our advanced 230 terminal gives you a local display list for interactive design applications.

Every terminal we make comes with a full one year warranty.

And because they're fully compatible, you can upgrade from one Envision terminal to another as your needs grow. Speaking of needs, you're



going to like the human engineering aspects of our terminals almost as much as the capability they give you.

Our 215 for instance is small and ergonomically designed with a detached compact keyboard plus full tilt and swivel convenience. And cursor control can be mouse-driven for optimum operator convenience.

ONE RED HOT OFFER YOU SHOULDN'T PASS UP

We think you'll be impressed with our 215. But don't just take our word for it. Pick up your telephone and call us about a free demo. Or send us the coupon. You'll not only see that our new Envision 215 is a great color graphics terminal. It's also a great color alphanumeric terminal. Best of all, the alphanumeric are yours. Free.

So show a little sporting interest and take us up on our offer. You'll get a red hot demo and a chance to buy two color terminals-in-one. At a price that makes our competitors green with envy. Send us the coupon or call. Envision, 631 River Oaks Parkway, San Jose, CA 95134, (408) 946-9755 or Telex: 176437.

Display samples courtesy of: Megatek and Precision Visuals, Inc.

OK, ENVISION... I CAN'T PASS IT UP. PLEASE CALL ME FOR A DEMO.

MM 11/83

NAME _____

TITLE _____

COMPANY _____

ADDRESS _____

CITY _____

STATE, ZIP _____

PHONE _____

Envision

EMULATION PLUS + AMBER

FROM AMPEX

The figures are in. Ampex Emulation Plus terminals with ergonomically superior Amber now outsell our white and green phosphor VDT's 4 to 1. But the choice is still yours. With all three colors available as standard on all three Ampex ASCII editing terminals, you've got flexibility.

Built-in flexibility to emulate up to 20 popular models*, with eight resident character sets in your choice of detached selectric-type or programmer

*Including models from TeleVideo, Lear Siegler, ADDS, Hazeltine, DEC, and SOROC.

keyboards. Price flexibility, starting with our new low-cost D125, on up to our D150 and D175. Flexibility to customize both hardware and firmware. And most importantly, maintenance flexibility through a nationwide network of TRW service centers. That's total flexibility.

Find out why Ampex Emulation Plus terminals with Amber are challenging the market with loads of features and flexibility at a price you won't believe. Call your nearest Ampex distributor, or give us a call direct at 213-416-1575.



AMPEX

COMPUTER PRODUCTS DIVISION

200 North Nash Street
El Segundo, California 90245

Ampex Corporation • One of The Signal Companies

CIRCLE NO. 66 ON INQUIRY CARD

TERMINALS

Low-cost display terminals gain in capability

MALCOLM STIEFEL, Contributing Editor

Less-than-\$1,000 full-screen alphanumeric terminals provide features typical of their higher-priced counterparts.

Creating color graphics in eight colors is no problem with the Intecolor 2405 from Intelligent Systems Corp. The \$995 (100) VT100-compatible display terminal also provides eight background colors, setup mode and two pages of screen RAM.



Low-cost full-screen alphanumeric display terminals are no longer merely "dumb" devices lacking local intelligence and editing capability. Terminals selling for less than \$1,000 are rapidly assuming many of the features provided by their higher-priced editing and intelligent terminal cousins. The line between high-end dumb terminals and lower-cost editing terminals is rapidly blurring as advances in microprocessor technology drive prices down and boost local-intelligence-implemented capabilities. Many low-cost terminals can thus boast impressive performance in terms of data-transmission rates, emulation, editing capabilities and graphics functions.

The table profiles full-screen, single-user alphanumeric display terminals comprising a CRT screen, a keyboard for data entry and a communications facility for exchanging data with remote computers and other terminals. A few terminals are configured for read-only operation. Less-than-full-screen, portable terminals employing liquid-crystal displays are not included in the

table (see "Accessing computers from the field," Page 144). Most units use an 80-column-by-25-line display, with 25th line serving as a status line controlled by the host computer. Some manufacturers, including DTI Data Terminals Corp. and Teletype Corp., offer 132-column options, useful for spreadsheet applications. Although color can be a valuable attribute, especially in business applications, only four of the terminal vendors surveyed offer color displays in less-than-\$1,000 terminals.

Profiling color units

The Intecolor 2405 from Intelligent Systems Corp. is typical of the color terminals surveyed. It provides eight foreground and eight background colors, an 80-by-24 display and 72 optional function-keyed definitions. The VT100 and American National Standards Institute (ANSI) X3.64-system-compatible unit handles 50- to 19.2K-baud data transmission and furnishes vector graphics, a setup mode and two pages of screen

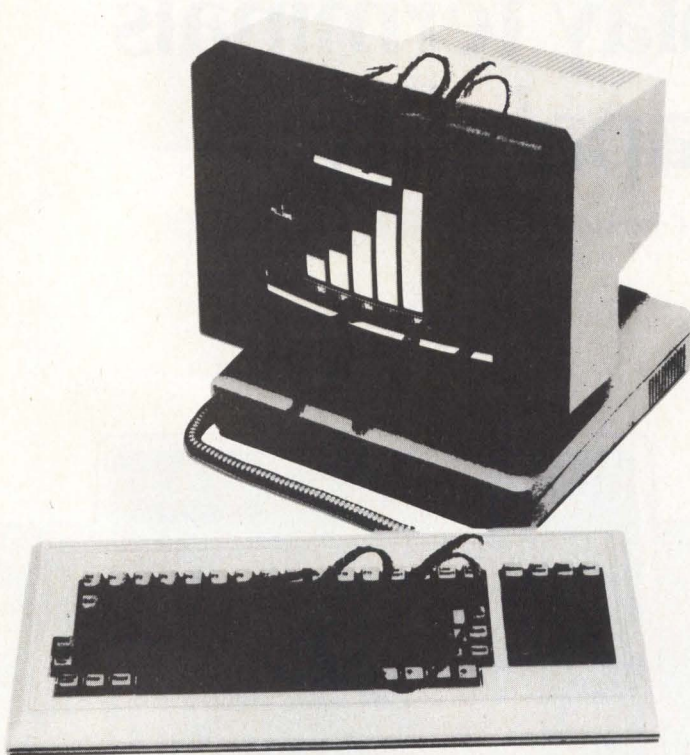

Eleven programmable function keys (22 functions) ease data entry and manipulation in Qume Corp.'s QVT 108 80-column-by-25-line terminal. Sporting an adjustable tilt/rotate 12- or 14-inch-diagonal screen, the \$895 unit transmits at rates as high as 19.2K baud, furnishes five video attributes and includes editing functions.

RAM for display information. Also providing eight colors for its display, Hazeltine Corp.'s Esprit III color terminal uses a 12-inch CRT, an 80-by-25 screen format and RS232C and 20-mA current-loop interfaces. In addition to 11 programmable function keys (22 functions), it features line graphics, character/line editing

Low-cost but not dumb terminals, the SW10 from General Terminal Corp. (left) and the ADM 22 from Lear Siegler Inc. both furnish 12-inch-diagonal displays, detachable keyboards, setup modes and numeric keypads. The SW10 also provides eight programmable functions, split-screen capability and 11 international keyboards; the ADM 22 provides editing functions and business graphics.



and as many as four pages of screen memory. Not to be outdone, Applied Digital Data Systems (ADDS) Inc. offers its 13-inch Viewpoint/Color unit. Furnishing eight colors and reverse-video, half-intensity, underlining and blinking display capabilities, it also sports RS422 and optional current-loop interfaces and business-graphics capability. Last, but not least, Panasonic Industrial Co. offers the \$450 10-inch DT-D1000G and the \$540 13-inch DT-D1300D color terminals. Both provide a 40-or 80-column-by-25-line display and graphics capabilities.

Transmitting as fast as 19.2K baud

Vendors have made great strides in beefing up the interface capability of low-cost terminals. System users can now communicate at suitably high speeds with a broad range of devices. Many units carry a second port for interconnection with local printers or other peripherals, reflecting the drive toward distributed processing and the off-loading of mundane tasks, such as printing the contents of a terminal screen, from host computers.

Color displays highlight business graphics.

Most low-cost terminals profiled use serial RS232 communications at speeds as high as 19.2K baud, permitting a screenful of characters to be transmitted in 1 second. This data-rate capability proves useful in database or text-file applications. And, if a multipointing arrangement is employed, several low-duty-cycle terminals can share one line at 19.2K baud, thereby providing better performance at lower line charges per terminal.

System integrators searching for still higher data rates should check out Soroc Technology Inc.'s model C540 terminal: it functions at speeds as high as 38.4K

What Makes A Supermicro Company Super?

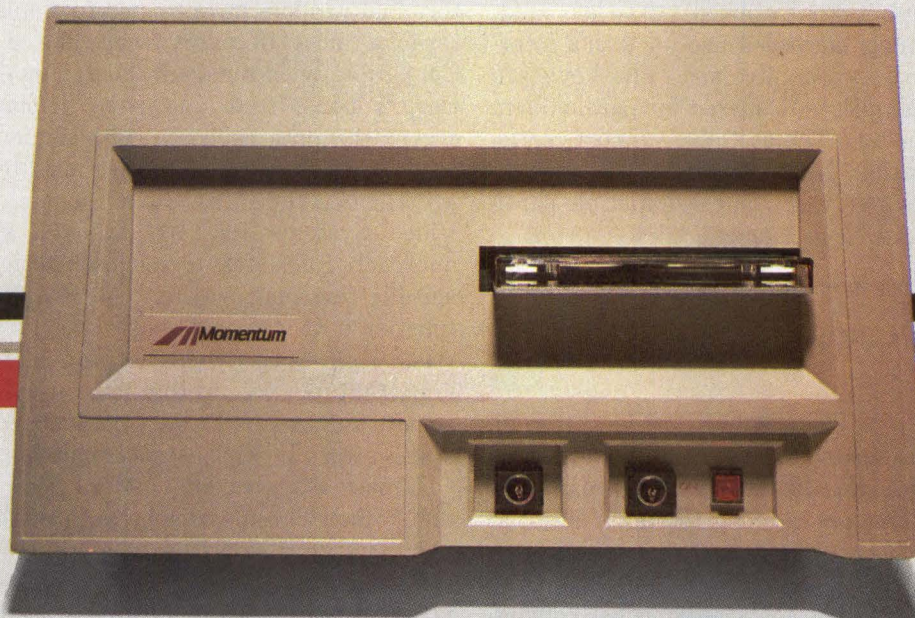

Start With A Super Supermicro.

The Momentum 32/E.TM A powerful OEM business computer that truly earns its "supermicro" status by delivering the high-performance characteristics of a midrange minicomputer at the price of a micro.

In throughput benchmarks against the VAX 11/780TM, the 32/E performed to 80% of the VAX standard. And when you consider their relative purchase price, the 32/E delivers 80% of the VAX's performance—at 10% of the price.

Beyond performance, the 32/E offers optimum cost efficiency, configuration flexibility and ease of maintenance; the powerful M68000TM micro-processor; our proprietary Memory Management Unit that can enhance system performance by as much as 20%; and Direct Memory Access that further improves system performance in multiuser environments.

Our One Unbending Standard: Flexibility.

We know that design flexibility is the key to an OEM's success. The versatility of the 32/E's multiuser/multitasking UNIXTM operating system provides that key. The 32/E can also be configured with up to one Mbyte of RAM. There are slots for up to eight serial I/O controllers—each with two serial ports (RS-232, Current Loop or RS-422). Moreover, each serial card can be interchanged with a microprocessor-based

intelligent communications controller for even greater system performance.

The Product Is The Bottom Line.

For OEMs, that means the product's performance, reliability, versatility and, of course, price. So if you're considering computers—especially 68000/UNIX-based systems, consider that no one offers a broader line than Momentum, from the super workstation 32/4TM to the super "workhorse" Momentum 32/E. Consider our 98.5% out-of-box quality record. Our comprehensive nationwide support program. And the fact that our systems are available now in the production quantities you want. At Momentum, we view every aspect of our operation as an extension of your operation—from engineering to manufacturing to quality control.

Some other OEM companies talk about "warm and cozy" commitments. At Momentum, we feel the only commitment that counts is delivering the best product. At the best price. And that's the bottom line reason for putting Momentum behind your system.

See us at Booth 2036.

Momentum

Momentum Computer Systems International
2730 Junction Avenue • San Jose, CA 95134
(408) 942-0638 • Telex: 184806 (TRT) • 172509 (WUT)

68000 is a trademark of Motorola Corporation.
UNIX is a trademark of Bell Laboratories.
VAX 11/780 is a trademark of Digital Equipment Corporation.

CIRCLE NO. 67 ON INQUIRY CARD

baud. At the other end of the spectrum are some hand-held, portable units that work at 110 to 300 baud.

Not all the terminals surveyed use an RS232 interface. Cromemco Inc.'s C-1 Monitor and CKBA keyboard combination, for example, is designed for parallel data transfer on the S-100 bus. The unit also supports serial Teletype communication. Nabu Commercial Terminals' model 5000 supports 8-bit Centronics-compatible parallel communication as well as RS232.

DIN low-profile-keyboard standard aids data entry.

Most vendors continue to cling to the RS232 interface, although the newer RS422 standard provides higher bit rates over longer distances. Among the few units that support RS422 are the ADM-11 from Lear Siegler Inc., which also works with RS232, and ADDS' Viewpoint/Color terminal, which has optional current-loop capability. Most vendors, however, will continue to avoid using RS422 until AT&T Information Systems Inc. makes a concerted thrust to push RS422-compatible devices in the field.

The proliferation of protocols and control codes among terminal and computer manufacturers has hampered terminal design. Digital Equipment Corp., for example, uses ANSI-standard escape sequences to control displays in its VT52 and VT100 terminals; other major computer vendors, such as IBM Corp., do not. To solve the problem of incompatible protocols and codes, terminal vendors have turned to emulation, in which a terminal acts in every way like a device that is compatible with a certain host. For example, Ampex Corp.'s D125, D150 and D175 display terminals can accept the data codes, escape sequences and control codes of 18 terminals manufactured by six companies: ADDS, DEC, Hazeltine, Lear Siegler, Soroc and Tele-Video Systems Inc. DTI takes a slightly different approach. Each of its terminals is designed to emulate a specific terminal, such as the Hazeltine 1510+ or to function with a specific host, such as a computer from Basic Four Corp. Emulation capability is particularly important for systems that must work with a variety of remote devices or to an OEM who wishes to make a system work in various environments.

Almost all terminal vendors compensate for their units' monochrome displays through liberal use of highlighting attributes such as reverse video, blinking characters, half-intensity displays, underlining and blanking (RevVid, Blink, HalfInt, Undrln, Blank in the table). Blinking characters can be used to draw an operator's attention to a condition requiring immediate action; reverse-video or half-intensity characters can distinguish protected fields with data to be held

ACCESSING COMPUTERS FROM THE FIELD

Although they don't have full-screen displays, low-cost hand-held, portable terminals can provide access through a built-in or external modem to remote computer systems or databases using regular phone lines or even a pay phone. Axlon Inc.'s (San Jose, Calif.) Datalink 1000 hand-held terminal, for example, furnishes an optional acoustic coupler interface with soft-rubber adapter cups, powered from the terminal, that snaps onto the mouthpiece and earpiece of pay and other non-modular telephones. Powered by four NiCd rechargeable batteries or four alkaline batteries, the \$399 1½-by-3¾-by-6¾-inch terminal has a built-in Bell 103-compatible modem, a 16-character green fluorescent display, a 224-character buffer and keyboard-selectable speeds of 110 or 300 baud. The RS232C serial port can access printers or personal computer systems with communications modems. A 40-character-per-line printer and television video-display interface with 2k wraparound memory buffer are optional. Another notable

hand-held terminal is the HT/1000 from Termiflex Corp. (Nashua, N.H.), one of a line of less-than-\$600 units. Using a red four-line, 16-character-per-line liquid-crystal display (LCD), the 7¼-by-4¾-by-1½-inch \$516.75 (100) device features four user-selectable baud rates spanning 150 to 19.2K, user-selectable parity options (odd, even, mark or space) and four programmable function keys. The battery or line-powered (4.5v to 28v

DC) terminal also provides three interfaces (RS232C, RS422, current loop), a self-test mode, cursor positioning, audible key feedback and parity-error display. The sealed keyboard permits it to be used in harsh environments. Finally, consider the MS/85 from MSI Data Corp. (Costa Mesa, Calif.). It uses a 16-character LCD and includes a 4K-to 32K-byte memory, an integral printer and bar-code-scanning capability. —J.V.



DISCOVER THE DYSAN DIFFERENCE

What Is The Dysan Difference?

Unmistakable quality. That's the Dysan difference. Only Dysan goes so far in every step of the design, manufacturing and testing processes to ensure precision magnetic media . . . the finest money can buy.

That's why, each and every Dysan Product—from Diskettes and Mini Diskettes to Disc Cartridges, Rigid Discs and Disc Packs—are certified 100% error-free.

And when you consider the amount of time and money you invest loading data onto magnetic media, can you really afford anything less than Dysan quality?

To order, just contact your local Dysan office. Or call us direct TOLL FREE at (800) 551-9000. Discover the difference Dysan quality can make for you.

dy Jan **Dysan**
CORPORATION

Corporate Headquarters:
5201 Patrick Henry Drive
Santa Clara, CA 95050
(800) 551-9000

See us at Comdex Booth #6005



CIRCLE NO. 68 ON INQUIRY CARD

constant, such as titles, from unprotected fields holding variable information. Blanking inhibits the display of system passwords.

Graphics advance

Human-engineering factors and graphics capabilities are becoming increasingly important in terminal design. Epic Computer Products Inc.'s 14E, for example, tilts through a 30-degree range and swivels through a full 360 degrees. Its detachable keyboard and that of the ADDS Viewpoint/Color terminal are claimed to meet the 1985 German Deutsches Institut für Normung (DIN) low-profile ergonomic standard of 30-mm. from desk surface to the top of the home row of keys. Several vendors are adding basic graphics symbols to the standard character sets in response to the apparent growing need for business graphics. With a suitable host-based software package, system integrators can provide users with the ability to create block diagrams, bar charts, pie charts and line graphs, which can be made into slides or transparencies for presentations. Teletype, for example, furnishes 96 line-drawing and graphics symbols in its model 5410. TeleVideo incorpo-

rates 15 graphics characters in its model 914 and 924 terminals.

Several vendors, with their sights set on worldwide markets, also offer foreign-character sets. Ampex D150 and D175 terminals, for example, are equipped with eight keystroke-selectable national character sets—for the United States, the United Kingdom, France, Germany, Italy, Norway, Spain and Sweden. Other terminals from manufacturers such as General Terminal Corp., IMS International and Liberty Electronics USA, come in foreign-character versions.

Terminal vendors are paying increasing attention to reliability and product life. For example, a special CRT-saver circuit in the Ampex and Epic terminals disables the display of on-screen information after several minutes of inactivity. The original display is reactivated automatically as soon as a key is touched or data is received from the host computer.

Most terminal keyboards are equipped with standard typewriter keys and numeric keypads, along with cursor-control and communication keys. Some also have programmable function keys that can improve throughput and reduce error from data entry in many applications. The Teletype 5410 is typical of many designs in this regard; it incorporates eight programmable function keys that can be used to recall strings with as many as 50 characters. Screen labels describing the stored strings can be used for accessing as many as 16 characters per key, eliminating the need for plastic strips or tapes on the keyboard. Key contents and labels can be entered from the keyboard or down-loaded from a remote host.

Many terminals have editing capability, reflecting the indebtedness of low-cost terminals to their higher-priced full-editing cousins. Editing functions can include insertion or deletion of lines or characters, erasure to end of page or end of line and replacement of characters by spaces or nulls. Lear Siegler goes further in its ADM 22 terminal. It permits defining protected fields, with erasures covering the area from the cursor position to the beginning or end of a line or page and encompassing all fields or only unprotected fields.

What the future holds

Driven by the steady advance of microprocessor technology, strong competitive pressures, economies of production and expanding markets, low-cost full-screen alphanumeric display terminals have progressed far beyond their dumb-terminal predecessors to encompass many of the features of full-fledged editing terminals. Market growth will continue to be healthy. International Data Corp. (IDC) estimates that shipments of dumb and editing terminals, the main constituents of the low-cost-terminal market, will expand at a 13 percent annual rate through 1986. These technology and market trends are sure to continue, leading to the possibility that *Mini-Micro Systems'* 1986 low-cost-terminal survey will feature full-featured intelligent workstations selling for less than \$1,000. □



Save Money—Play Safe

**“YOU CAN
DEPEND
ON US.”**

George Catha, Pres.

**UL-Classified
FIRE RESISTANT
LOW SMOKE, PLENUM CABLE**

To meet the new Fire Codes and avoid the costly installation of conduit, use approved Plenum cable. Data Set supplies regular and extended distance RS-232-C and coax that meet NEC Article 725 and 800 Fire Codes, with fire resistant outer jacket and primary conductors.

**FRC-EIA25—25 conductors,
all connected \$16.50 plus \$2.75/ft.**

**FRC-EDC25—25 conductors,
extended distance \$18.50 plus \$3/ft.**

CR-CAC62—Coaxial Cable \$8.00 plus \$1.15/ft.

Send for Catalog

**ds
cc**

**The Company with a lot of Connections
Data Set Cable Company, Inc.**

East
722 Danbury Road
Ridgefield, Connecticut 06877
(203) 438-9684 TWX-710-467-0668

West
3001 Contract Avenue
Las Vegas, Nevada 89101
(702) 382-6777

CIRCLE NO. 69 ON INQUIRY CARD

PERFORMANCE ARCHITECTURE:™

It's where technology and business meet.

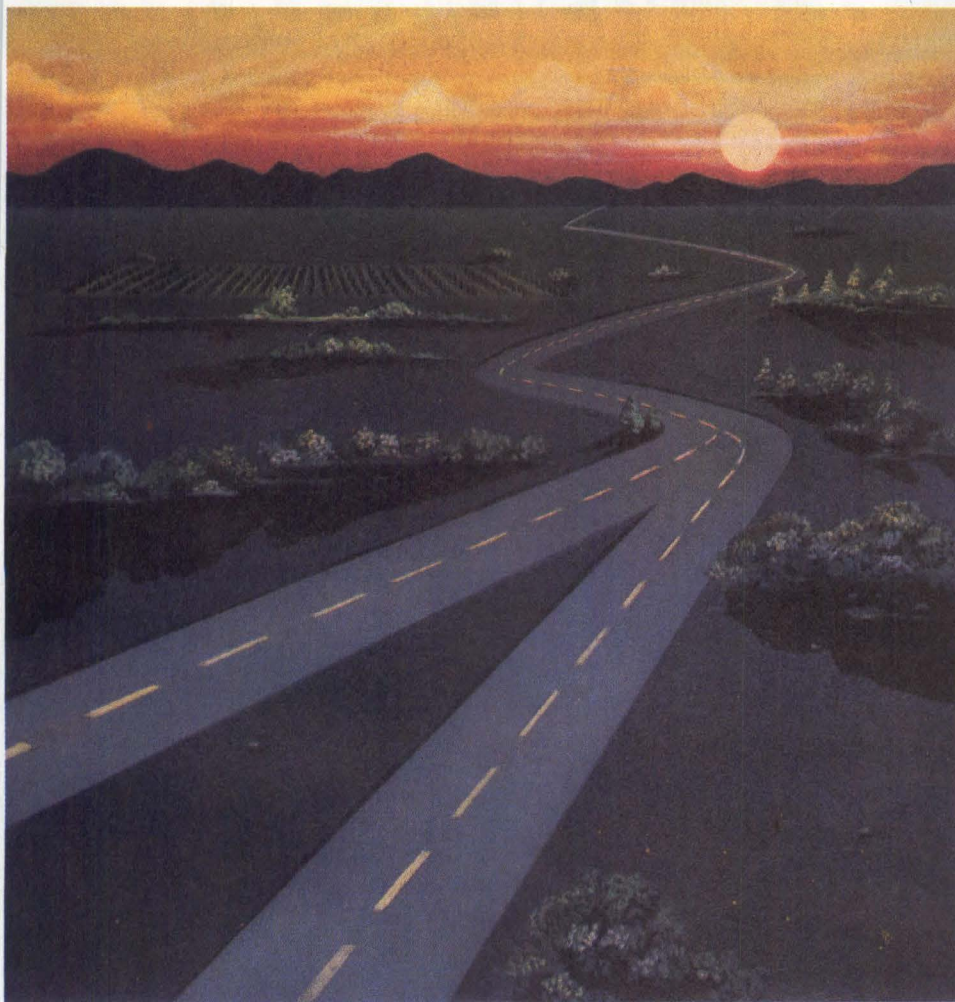

Masscomp's triple-bus Performance Architecture gives you unequalled performance. Our MC-500 system has a dual-processor CPU, up to 7 megabytes ECC memory, and independent processors for graphics and data acquisition subsystems. It offers you the *only* solution for *simultaneous* multi-user computation, high-performance graphics and high-speed data acquisition and control.

The MC-500 runs a combination of UNIX™ and the UC-Berkeley operating system, but with Masscomp-designed enhancements for increased performance, virtual memory and real-time operations. Supported languages include C, FORTRAN-77 and Pascal-2.™

For even greater performance, both floating-point and array processors are available.

Independently-conducted benchmarks have rated the MC-500's performance equal or superior to that of systems costing three times the price.

CIRCLE NO. 70 ON INQUIRY CARD

Performance for the OEM

For the OEM, Performance Architecture is even more powerful, allowing for unbundling of the system down to the board set level. The triple-

bus structure allows for flexibility in system component choices and future growth.

OEM-developed applications run on the industry-standard Multibus™ while the CPU runs on Masscomp's 8 MByte proprietary MC-500 bus. New semiconductor technology can thus be implemented—*without affecting existing applications and customer investment.*

Whether it's individual board sets, industry-standard "building block" components, workstations or an entire system, Masscomp offers you Performance Architecture under uniquely flexible terms. You'll also find our service and support options unique, including training for OEM staffs, and remote diagnosis to fully-supported installations.

For unmatched performance, price and support, follow the road to Performance Architecture. Call **800/451-1824** and ask for OEM Marketing.



MASSCOMP

One Technology Park
Westford, Massachusetts 01886
TWX: ESL 196520 Telex: 704353
Cable: MASSCOMP

Performance Architecture is a trademark of the Massachusetts Computer Corp. UNIX is a trademark of Bell Laboratories Pascal-2 is a trademark of Oregon Software Multibus is a trademark of Intel Corporation

**Winner of the 1983 I-R 100 Award
as one of the most significant
technical products of the year.**

Introducing VISION 2000+

The New Standard of Performance



VISION™ users are demanding. Whether they have DEC, HP, Prime or Tandem systems, they all run tough applications that demand high-performance terminals that don't take a big bite out of their budget.

VISION 2000+™ was engineered to meet the needs of professionals. With imaginative innovations like our Intelligent Function system. A new concept that gives the operator superior control of applications and terminal features.

VISION 2000+™ has Multi-Page capability that can mix 80 and 132-column pages of up to 97 lines in length. And with our high-resolution, 9 x 15 matrix, VISION 2000+™ has a display that is exceptionally crisp and readable even in 132-column mode.

Powerful options include the most extensive Blockmode capability we know of, and PLOT 10™ graphics for technical applications.

For less demanding tasks, we offer VISION 1000™. Economical, full-featured, VT100 compatible terminals with AVO and printer port.

Find out why we call our VISION Series CRT's **practical, high-performance terminals for demanding environments.** Call today for more details.

 **LANPAR**

Concord, MA (617) 371-0915 Chicago, IL (312) 628-1895
Corona Del Mar, CA (714) 760-6070

CIRCLE NO. 71 ON INQUIRY CARD

© 1983 Lanpar Technologies Inc. VISION Series CRT's are manufactured by Northern Technologies Ltd., a wholly-owned subsidiary of Lanpar Technologies Inc. VISION Series, VISION 2000+ and VISION 1000 are trademarks of Lanpar Technologies Inc; DEC and VT are trademarks of Digital Equipment Corporation; HP is a trademark of Hewlett-Packard Co.; Prime is a trademark of Prime Computer Inc; Tandem is a trademark of Tandem Computers; PLOT 10 is a trademark of TEKTRONICS, Inc.

LOW-COST FULL-SCREEN DISPLAY TERMINALS

Manufacturer, model	Display/Display characteristics	Screen format (col. x lines)	Keyboard	Interface	Price	Special features	Circle no.
Ampex Corp. 200 N. Nash St. El Segundo, Calif. 90245							831
Model D125	12-in. diag. CRT; RevVid, Blink, HalfInt; UndrIn, Blank; 8 national char. sets	80 x 25	numeric pad, 12 function keys	serial RS232, 20 mA current loop; 50 to 19200 baud; X-on/X-off protocol	\$679	editing features, setup mode, emulates 16 terminal types	
Model D150	12-in. diag. CRT; RevVid, Blink, HalfInt; UndrIn, Blank, double-size characters; 8 national char. sets	80 x 25	programmer layout, numeric pad, 20 programmable function keys	serial RS232, 20 mA current loop; 50 to 19200 baud; X-on/X-off protocol	\$849	editing features, setup mode, block and line graphics, scroll in 48-line field, emulates 16 terminal types	
Model D175	12-in. diag. CRT; RevVid, Blink, HalfInt; UndrIn, Blank, double-size characters; 8 national char. sets	80 x 25	selectric layout, numeric pad, 20 programmable function keys	serial RS232, 20 mA current loop; 50 to 19200 baud; X-on/X-off protocol	\$869	editing features, setup mode; block and line graphics; scroll in 48-line field; emulates 16 terminal types	
Applied Digital Data Systems 100 Marcus Blvd. Hauppauge, N.Y. 11788							832
Viewpoint	12-in. CRT	80 x 24		RS232, current loop	\$650	graphics capabilities	
Viewpoint/A1	12-in. CRT, 5 visual attributes	80 x 24	detachable	RS232C, CCITT 2.24; switch-selectable communications speeds	\$650		
Viewpoint 60	12-in. CRT	80 x 25		RS232, current loop	\$895	graphics capabilities	
Viewpoint/Color	13-in. CRT; 8 colors; RevVid, HalfInt, UndrIn, Blink	80 x 25		RS422, current-loop optional	\$995, qty. 100	business graphics capability	
Axlon Inc. 70 Daggett Dr. San Jose, Calif. 95134							833
Datalink 1000	fluorescent display, 0.5-x 3.75-in. CRT	80 x 25	typewriter keys	serial RS232, read only; 110 to 300 baud; teletype protocol; built-in Bell 103-compatible modem; 224-character buffer	\$399	portable; weighs 10 oz.	
Cromemco Inc. 280 Bernardo Ave. Mountain View, Calif. 94039							834
C-1 monitor & CKBA keyboard	12-in. diag. CRT; RevVid, Blink, HalfInt, UnderIn; graphics, bold, tech/math characters	80 x 25	numeric keypad	S-100 bus compatible; parallel lines, as many as 25,000 bits/sec.; teletype protocol, built-in Bell 103-compatible modem	\$885	portable; weighs 10 oz.	
DTI Inc. 30 Uxbridge Rd. Mendon, Mass. 01756							835
Basic IV	12-in. diag. CRT; RevVid, Blink, HalfInt, UnderIn	80 x 24	numeric keypad, detached keyboard	RS232, 20 mA current loop; X-on/X-off protocol; 50 to 19200 baud; compatible with Basic Four computers	\$995, qty 1; \$850, qty 20		
E52	12-in. diag. CRT; RevVid, Blink, HalfInt, UnderIn	80 x 24	numeric keypad, detached keyboard	RS232, 20 mA current loop; X-on/X-off protocol; 50 to 19200 baud; compatible with DEC E52 code	\$995, qty 1; \$850, qty 20		
1510 +	12-in. diag. CRT; RevVid, Blink, HalfInt, UnderIn	80 x 24	numeric keypad, detached keyboard	RS232, 20 mA current loop; X-on/X-off protocol; 50 to 19200 baud; compatible with Hazeltine 1510 +	\$995, qty 1; \$850, qty 20		

IN OCTOBER 1984, 1 MEGABIT BUBBLES WILL BE \$99.*

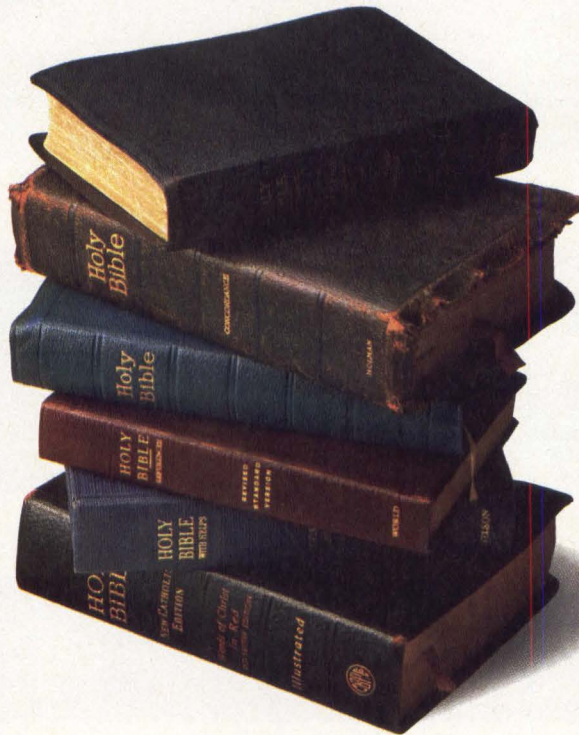

See us at Wescon Booth #3216

See us at Mini-Micro Booth #5632

*In 1980, we guaranteed the lowest 1 MB bubble price through 1982 and delivered. Now we're doing it again. With our BPK70-4, in quantities of 25,000 or more. So call (800) 538-1876 for details. In California, (800) 672-1833. And book your order now.

intel delivers
solutions

© 1983 Intel Corporation

LOW-COST FULL-SCREEN DISPLAY TERMINALS

Manufacturer, model	Display/Display characteristics	Screen format (col. x lines)	Keyboard	Interface	Price	Special features	Circle no.
Prism	12-in. diag. CRT; RevVid, Blink, HalfInt, Underln	80 x 24	numeric keypad, detached keyboard	RS232, 20 mA current loop; X-on/X-off protocol; 50 to 19200 baud; Prism code compatible	\$995, qty 1; \$850, qty 20		
FALS 200	12-in. diag. CRT; RevVid, Blink, HalfInt, Underln	80 x 24	numeric keypad, detached keyboard	RS232, 20 mA current loop; X-on/X-off protocol; 50 to 19200 baud; Lear Siegler code compatible	\$995, qty 1; \$850, qty 20		
Genius	12-in. diag. CRT; RevVid, Blink, HalfInt, Underln	80 x 24	numeric keypad, detached keyboard	RS232, 20 mA current loop; X-on/X-off protocol; 50 to 19200 baud; Lear Siegler code compatible	\$995, qty 1; \$850, qty 20		
DTI 6053	12-in. diag. CRT; RevVid, Blink, HalfInt, Underln	80 x 24	numeric keypad, detached keyboard	RS232, 20 mA current loop; X-on/X-off protocol; 50 to 19200 baud; Data General 6053 code compatible	\$995, qty 1; \$850, qty 20		
DTI 200	12-in. diag. CRT; RevVid, Blink, HalfInt, Underln	80 x 24	numeric keypad, detached keyboard, function keys	RS232, 20 mA current loop; X-on/X-off protocol; 50 to 19200 baud; Data General 200 code compatible	\$995, qty 1; \$850, qty 20		
Editor	12-in. diag. CRT; RevVid, Blink, HalfInt, Underln	80 or 132 x 24	numeric keypad, detached keyboard, function keys	RS232, 20 mA current loop; X-on/X-off protocol; 50 to 19200 baud; DEC VT100 code compatible	\$995, qty 1; \$850, qty 20		
Proterm 80	12-in. diag. CRT; RevVid, Blink, HalfInt, Underln	80 or 132 x 24	numeric keypad, detached keyboard, programmable function keys	RS232, 20 mA current loop; X-on/X-off protocol; 50 to 19200 baud; DEC VT100 code compatible	\$995, qty 1; \$850, qty 20		
Epic Computer Products Inc. 18381 Bandilier Circle Fountain Valley, Calif. 92708							836
Epic 14E	14-in. diag. CRT; RevVid, Blink, HalfInt, Underln, Blank; 48 foreign characters; line and block graphics	80 x 24	numeric keypad, 8 dedicated and 3 programmable function keys	RS232, 20 mA current loop; X-on/X-off and DTR protocol; 50 to 19200 baud	\$995, qty 1; \$645, qty 100	real-time clock display, CRT saver circuit	
Hazeltine Terminals Div. of Esprit Systems Inc. 100 Marcus Dr. Melville, N.Y. 11747							837
Esprit III Color	12-in. color CRT, 8 colors	80 x 25	detached, 11 programmable function keys	RS232C, 20 mA current loop	\$995	line graphics, character/line editing, as many as 4 pages of memory	
Executive 10/102	14-in. CRT	80 x 132	8 programmable function keys	RS232C, 20 mA current loop	\$995	line graphics, DEC VT100 emulation, menu-selectable setup	
Falco Data Products 1286 Lawrence Station Rd. Sunnyvale, Calif. 94089							838
Fame 2	12-in. or 15-in. diag. CRT; RevVid, Blink, HalfInt, Underln; non-embedded video attributes; tilt and swivel housing	80 x 24	numeric keypad, 20 programmable function keys	RS232, RS422, 20 mA current loop; X-on/X-off and DTR protocol; 50 to 19200 baud	\$695	setup mode	
Falco 2	12-in. diag. CRT; RevVid, Blink, HalfInt, Underln; non-embedded video attributes	80 x 24	numeric keypad, 20 programmable function keys	RS232, RS422, 20 mA current loop; X-on/X-off and DTR protocol; 50 to 19200 baud	\$695	software-based setup mode, compatible with ANSI X3.64	

LOW-COST FULL-SCREEN DISPLAY TERMINALS

Manufacturer, model	Display/Display characteristics	Screen format (col. x lines)	Keyboard	Interface	Price	Special features	Circle no.
General Terminal Corp. 14831 Franklin Ave. Tustin, Calif. 92680							
SW10	12-in. CRT; RevVid, Blink, HalfInt, UndrIn; double high/wide, split screen	80 x 25	8 programmable function keys, 11 international versions	RS232, 20 mA current loop option, 50 to 9.6K baud; X-on/X-off	\$849	ANSI X3.64 compatible, setup mode	839
IMS International 2800 Lockheed Way Carson City, Nev. 89701							
Ultima	12-in. CRT	80 x 25	French, German, Spanish versions	as high as 19.2K baud, full modem interface	\$950	graphics capability	840
Intecolor Div. of Intelligent Systems Co. 225 Technology Park Norcross, Ga. 30092							
2405	12-in. CRT; 8 foreground, 8 background colors	80 x 24	72 optional function-key definitions	50 to 19.2K baud	\$995, qty 100	VT100 compatible, ANSI X3.64 system compatible, VT52 mode, vector graphics, setup mode, 2 pages of screen RAM	841
Lear Siegler Inc. Data Products Division 714 N. Brookhurst St. Anaheim, Calif. 92803							
ADM-3A	12-in. diag. CRT	80 x 24	numeric keypad optional	RS232, 20 mA current loop; teletype protocol; 75 to 19200 baud	\$595		842
ADM 5	12-in. diag. CRT; RevVid, HalfInt	80 x 24	numeric keypad	RS232, 20 mA current loop; teletype protocol; 75 to 19200 baud	\$645	limited editing features	
ADM 11	12-in. diag. CRT; RevVid, Blink, HalfInt, Blank; tilt and swivel housing	80 x 25	numeric keypad, 4 programmable function keys, tilt and swivel mechanism, DIN standard compatible	RS232, RS422, 20 mA current loop; teletype, X-on/X-off and DTR protocol; 300 to 19200 baud	\$695		
ADM 22	12-in. diag. CRT; RevVid, Blink, HalfInt, UndrIn; protected fields	80 x 25	numeric keypad, 7 function keys	RS232, 20 mA current loop; teletype, X-on/X-off protocol; 75 to 19200 baud	\$695	editing features; compatible with ADM-3A, 5, 31, Hazeltine 1500, and ADDS Regent 25; business graphics; self-test mode	
ADM 23	12-in. CRT; protected fields; RevVid, Blink, UndrIn, Blank	80 x 24	numeric pad, 8 function keys, international character sets optional	RS232C, 20 mA current loop optional; 75 to 19.2K baud	\$795	editing functions, block mode operation, 2 pages of display memory, self test mode	
Liberty Electronics USA 100 Clement St. San Francisco, Calif. 94118							
F-50	12-in. CRT	80 x 25	foreign character sets	RS232C, 20 mA current loop	\$395	optional graphics, block mode	843
F-100	12-in. CRT	80 x 25	foreign character sets, 10 function keys, numeric pad	RS232C, 20 mA current loop	\$495	15 line-graphics symbols, 7 editing functions	
Micro-Term Inc. 512 Rudder Rd. St. Louis, Mo. 63026							
ERGO-201	12-in. CRT; RevVid, HalfInt, UndrIn, Blink, Blank	80 x 25	16 programmable function keys	RS232	\$695	emulates Televideo 925, Lear Siegler ADM-3A, DEC VT52, Micro-Term ACT-5A; setup mode; alternate-character, graphics options; custom mode	844

High resolution, low cost graphics should be more than a retrothought.

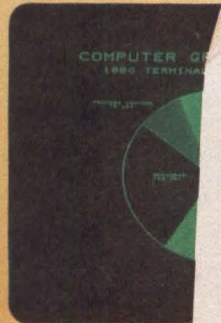
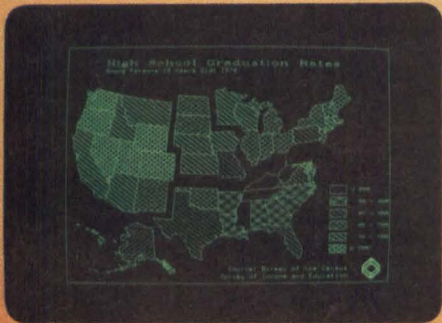
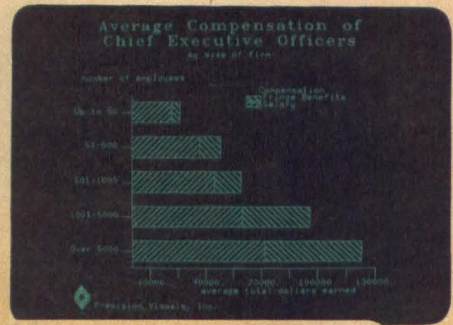
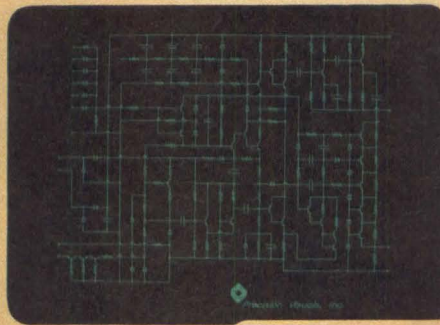
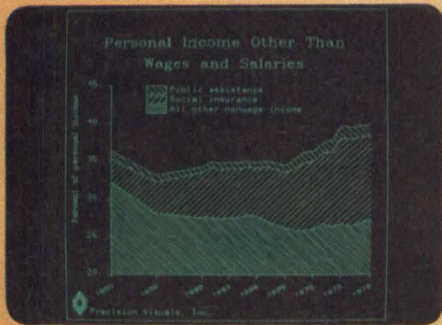

Why settle for a low resolution retrofit graphics terminal when you can have a VISUAL high resolution terminal with quality and reliability built in. And at a cost that makes retrofits overpriced.

The VISUAL 500 and VISUAL 550 emulate the Tektronix® 4010/4014 but cost only about half as much. And they provide 585(V) x 768(H) resolution for sharp text and graphic display on a large 14" screen without the need to add boards or change the CRT. This superior resolution offers the ideal vertical to horizontal dot density ratio of 1:1 for balanced images and reduces the "stairstep" effect you get with most retrothoughts.

The VISUAL 500 provides selectable emulations of the DEC VT52, Data General D200, Lear Siegler ADM3A, and Hazeltine 1500 terminals. The VISUAL 550 is DEC VT100 protocol-compatible as well as a character or block mode terminal which complies to the ANSI X3.64 standard.

Call or write for a free comprehensive reference booklet on graphics terminals including a glossary of graphics buzzwords.

VISUAL 500/550

	VISUAL		RETROTHOUGHTS						
			DIGITAL ENGINEERING				SELANAR		
	500	550	VT640S	VT640	DQ650S	DQ650M	SG100 PLUS	SG200	SG480
Vertical Resolution	585	585	240	480	240	480	240	240	480
Horizontal Resolution	768	768	640	640	800	800	1225	1225	780
Dot Density Ratio	1:1	1:1	1:2	1:1	1:3	1:1	1:4	1:4	1:1
Screen Size	14"	14"	12"	12"	12"	12"	12"	12"	12"
Tektronix 4014 Compatible	STD	STD	NO	NO	NO	STD	NO	STD	STD
Data Tablet Support	STD	STD	NO	NO	OPT	OPT	NO	NO	NO
Multi-Vendor Printer Support	STD	STD	OPT	OPT	OPT	OPT	OPT	OPT	OPT
8 Dir. Cross Hair Cursor	STD	STD	NO	NO	NO	NO	OPT	OPT	OPT
Programmable Function Keys	STD	STD	NO	NO	NO	NO	NO	NO	NO
Tilt/Swivel Enclosure	STD	STD	NO	NO	NO	NO	NO	NO	NO
Compatibility	VT52	VT100	VT100	VT100	VT100	VT100	VT100	VT100	VT100
	ADM3A	VT52	VT52	VT52	VT52	VT52	VT52	VT52	VT52
	H1500	ANSI							
	D200	X3.64							
PRICE (suggested list*)	\$2,495	2,695	3,025	3,355	3,025	3,510	2,890	3,390	3,190

*Retrothoughts price includes DEC VT100 terminal based on published information as of 4/1/83.

VISUAL

See for yourself

Visual Technology Incorporated
 540 Main Street, Tewksbury, MA 01876
 Telephone (617) 851-5000. Telex 951-539

LOW-COST FULL-SCREEN DISPLAY TERMINALS

Manufacturer, model	Display/Display characteristics	Screen format (col. x lines)	Keyboard	Interface	Price	Special features	Circle no.
ERGO-301	12-in. CRT	80 or 132 x 25	function keys	RS232	\$895	DEC VT100 emulation, 2 pages of memory, graphics options	
Mime-340	12-in. CRT	80 x 24		RS232	\$750	emulates DEC VT52, Hazeltine 1410, Lear Siegler ADM 3A; ANSI X3.64, APL compatible	
ACT-5A	12-in. CRT; HalfInt, RevVid, Blink, UndrIn	80 x 24	8 function keys	RS232	\$995		
Nabu Commercial Terminals Ltd. 330 Weber St. N. Waterloo, Ontario, N2J 3H6, Canada							845
Nabu 3100	12-in. diag. CRT; RevVid, Blink, HalfInt, UndrIn; double width characters	80 x 24	numeric keypad	RS232, 20 mA current loop; X-on/X-off and DTR protocol; 50 to 9600 baud	\$1,095, qty 1; \$855, qty 100		
Nabu 4404	12-in. diag. CRT, HalfInt	80 x 24	numeric keypad	RS232, 20 mA current loop; X-on/X-off and DTR protocol; 50 to 19200 baud	\$695, qty 1; \$525, qty 100		
Nabu 5000	12-in. diag. CRT; RevVid, Blink, HalfInt, UndrIn	80 x 24	numeric keypad, optional auxiliary keypad	RS232, 20 mA current loop; X-on/X-off and DTR protocol; 50 to 19200 baud; 8-bit parallel, Centronics compatible, read only	\$795, qty 1; \$615, qty 100		
NCR Corp. S. Patterson Blvd. Dayton, Ohio							846
Model 7901	12-in. diag. CRT; RevVid, Blink, HalfInt, UndrIn, Blank	80 x 24	numeric keypad	RS232, teletype protocol, 110 to 19200 baud	\$850		
Protocol Computers 6150 Canoga Ave. Woodland Hills, Calif. 91367							848
PCI 51	12-in. CRT	80 x 25	detachable, ASCII plus special EBCDIC characters	RS232	\$995		
PCI 78	12-in. CRT	80 x 25	detachable, ASCII plus special EBCDIC characters	RS232	\$995		
Qume Corp. 2350 Qume Dr. San Jose, Calif. 95131							849
QVT-102	12- or 14-in. diag. CRT; RevVid, Blink, HalfInt, UndrIn	80 x 25	numeric keypad	RS232, 20 mA current loop; X-on/X-off and DTR protocol; 50 to 19200 baud	\$695, qty 1; \$417, qty 1,000		
QVT-108	12- or 14-in. diag. CRT; RevVid, Blink, HalfInt, UndrIn	80 x 25	detachable, numeric keypad, 11 programmable function keys	RS232, 20 mA current loop; X-on/X-off and DTR protocol; 50 to 19200 baud; auxiliary serial port	\$895, qty 1; \$537, qty 1,000	line-drawing capability, 2 pages of memory, set-up mode	
Soroc Technology Inc. 161 Freedom Ave. Anaheim, Calif. 92801							850
C530	12-in. diag. CRT; RevVid, Blink, HalfInt, UndrIn	80 x 25	numeric keypad, programmable function keys, detached keyboard	RS232, 20 mA current loop; teletype and X-on/X-off protocol; 15.5 to 38400 baud; integral 212A modem optional	\$695	optional integral modem, optional expanded non-volatile RAM, line graphics option	
C540	12-in. diag. CRT; RevVid, Blink, HalfInt, UndrIn	80 x 25	numeric keypad, programmable function keys, detached keyboard, tilt and swivel mechanism	RS232, 20 mA current loop; teletype and X-on/X-off protocol; 15.5 to 38400 baud; integral 212A modem optional	\$995	optional integral modem, optional expanded non-volatile RAM, setup mode, line graphics option	

INTRODUCING HIGH PERFORMANCE

Fame

Falco's new family of high performance terminals are loaded with standard features and options unmatched by anyone in the industry and are designed to meet the needs of today's ever demanding and fast-paced business environment.

Fame II offers:

- ANSI x 3.64
(ADM 31* & VT 52* Modes)
- 22 Non-volatile Function Keys
- Soft Set-up Screen
- Non-embedded Video Attributes
- Buffered Printer Port

options:

- Graphic Board (Tektronics Plot 10* Compatible)
- 212 Plus Modem (300/1200 Bps)
- 64K CP/M* Board
- Amber or B/W Screens
- IBM style Keyboard available on Fame II and Fame III.

Call now and discover what proven reliability and high performance can mean for your business needs today . . . and tomorrow!



Falco
DATA PRODUCTS

1286 Lawrence Station Road
Sunnyvale, CA 94089

15" Monitor Shown

ADM is a registered trademark of Lear Siegler, Inc. VT is a registered trademark of Digital Equipment Corp. Plot 10 is a registered trademark of Tektronics, Inc. CP/M is a registered trademark of Digital Research Corp.

(408) 745-7123

CIRCLE NO. 73 ON INQUIRY CARD

See us at
COMDEX™
Fall '83
BOOTH 3760

David, Jack & PAT™

Size has always been a most formidable foe. Tales of David and Goliath and Jack and the Beanstalk are clear examples of how "Bigger is not always better". In fact, throughout history, all great giant killers have had one thing in common... small size but a surprisingly big capability.

And now, there's PAT, Dysan's unique Performance and Alignment tester that cuts giant floppy drive problems down to size.

PAT is the first hand-held intelligent tester for flexible diskette drives. Used in conjunction with Dysan's Digital Diagnostic Diskette (DDD)™, PAT's versatile and precise testing capabilities can test drive alignment and performance criteria. Plus, PAT also checks read/write data handling functions and serves as an

exerciser without the use of additional equipment, all with minimal operator instruction. And best of all, PAT sells for a small fraction of what the big testers cost.

PAT's Giant-Size Capabilities Include:

- Head radial alignment
- Head positioner linearity
- Head azimuth alignment
 - Index timing
- Head positioner skew
 - Spindle speed
- Read/write verification
- Seek test verification

For quality assurance, field service, incoming inspection, engineering evaluation and field disk drive sales, discover PAT. Another big difference from Dysan.

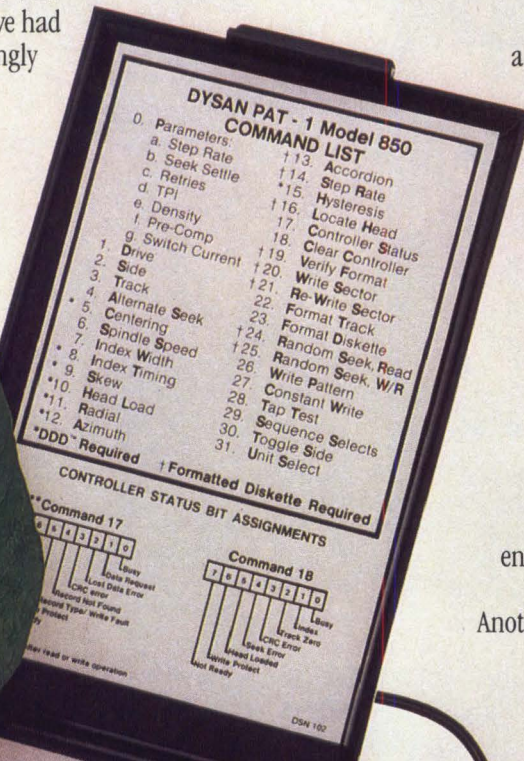

Corporate Headquarters
5201 Patrick Henry Drive
Santa Clara, CA 95050
(800) 551-9000
(408) 988-3472



For more information on PAT, call toll free (800) 551-9000 or (408) 988-3472. Ask about our limited-time bonus offer!

See us at Comdex
Las Vegas, Booth #6005.

CIRCLE NO. 74 ON INQUIRY CARD

LOW-COST FULL-SCREEN DISPLAY TERMINALS

Manufacturer, model	Display/Display characteristics	Screen format (col. x lines)	Keyboard	Interface	Price	Special features	Circle no.
Teletype Corp. 5555 Touhy Ave. Skokie, Ill. 60077							
							851
Model 5410	12-in. diag. CRT; RevVid, Blink, HalfInt, UndrIn; horizontal split screen; 96 line drawing and graphics symbols; 4 windows	80 or 132 x 24	numeric keypad, 8 screen-labeled function keys, detached keyboard	RS232, 20 mA current loop; teletype protocol; 300 to 19200 baud; auxiliary printer port	\$995	ANSI X3.64 compatible	
TeleVideo Systems Inc. 1170 Morse Ave. Sunnyvale, Calif. 94086							
							852
Model 910	12-in. diag. CRT; RevVid, Blink, HalfInt, UndrIn	80 x 24	numeric keypad	2 RS232, 20 mA current loop; X-on/X-off and DTR protocol; 50 to 19200 baud	\$649	emulates Lear Siegler ADM 3A and ADM 5, ADDS 25, and Hazeltine terminals; logical attributes; block mode, protect-mode options	
Model 914	12-in. diag. CRT; RevVid, Blink, HalfInt, UndrIn, Blank; tilt and swivel housing; 15 graphics characters	80 x 24	numeric keypad; 3 or 6 non-volatile function keys	2 RS232, 20 mA current loop; X-on/X-off and DTR protocol; 150 to 19200 baud; serial printer port	\$699	emulates ADDS Viewpoint terminal, non-volatile setup	
Model 924	12-in. diag. CRT; RevVid, Blink, HalfInt, UndrIn, Blank; all attributes non-embedded; tilt and swivel housing; block graphics characters	80 x 24	reconfigurable, numeric keypad, 16 or 32 non-volatile programmable function keys	2 RS232, 20 mA current loop; X-on/X-off and DTR protocol; 150 to 19200 baud; serial printer port	\$899	off-line editing, languages, logical attributes, non-volatile setup	
Model 925	12-in. CRT	80 x 25	detached	2 RS232, 20 mA current loop option	\$995	screen saver, time-of-day clock	
Visual Technology Inc. 540 Main St. Tewksbury, Mass. 01876							
							853
V50	12-in. diag. CRT; RevVid, Blink, HalfInt, UndrIn, Blank; tilt and swivel housing; foreign character sets available	80 x 24	numeric keypad, detached keyboard	RS232, 20 mA current loop; X-on/X-off and DTR protocol; 50 to 19200 baud; serial printer port	\$695	emulates DEC VT52, Lear Siegler ADM 3A, ADDS Viewpoint, and Hazeltine Esprit terminals	
V55	12-in. diag. CRT; RevVid, Blink, HalfInt, UndrIn, Blank; tilt and swivel housing; foreign character sets available	80 x 24	numeric keypad, 12 programmable function keys, detached keyboard	RS232, 20 mA current loop; X-on/X-off and DTR protocol; 50 to 19200 baud; serial printer port	\$895	emulates DEC VT52, Lear Siegler ADM 3A, ADDS Viewpoint, Hazeltine Esprit, and Visual 210 terminals	
Wicat Systems Box 539 Orem, Ut. 84057							
							854
T7000	12-in. CRT; HalfInt, RevVid, Blink, UndrIn, Blank	80 x 25		2 RS232C ports, 50 to 19.2K baud	\$1000, qty 500	user definable character set in EPROM, optional touch panel, ANSI X3.64 compatible, 2 page I/O buffer	
Wyse Technology 3040 N. First St. San Jose, Calif. 95134							
							855
WY-50	14-in. CRT	80 or 132 x 26	detached, DIN-standard design, 16 programmable function keys, numeric pad	RS232, transmission to 19.2K baud	\$695	soft setup mode, block mode	
WY-75	14-in. CRT	80 or 132 x 26	detached, DIN-standard design, 16 programmable function keys, numeric pad	RS232	\$795	conforms to subset of ANSI X3.64, soft setup mode, block mode	
WY-100	12-in. CRT; split screen (vertical, horizontal); RevVid, UndrIn, Blink, Blank	80 x 26	detached, numeric pad, 8 function keys	2 RS232, current loop optional; 50 to 9600 baud	\$995	editing functions, line graphics, block mode	

LOW-COST FULL-SCREEN DISPLAY TERMINALS

Manufacturer, model	Display/Display characteristics	Screen format (col. x lines)	Keyboard	Interface	Price	Special features	Circle no.
Zenith Data Systems 1000 Milwaukee Ave. Glenview, Ill. 60025							856
Z-19	12-in. diag. CRT; RevVid, Blink, Undrln	80 x 25	numeric keypad, 12 special-function keys	RS232, teletype protocol, 110 to 9600 baud	\$999, limited quantities	controlled by Z80 microprocessor; character/line deletion, insertion; business graphics	
ZT-1	12-in. diag. CRT; RevVid, Blinking block, Halfint	80 x 25	detached, numeric keypad, help key	RS232, teletype protocol, 110 to 2400 baud, serial printer port	\$499	emulates DEC VT52; accepts log-on sequences to 132 characters from mainframe; line deletion, insertion	
Z-29	12-in. diag. CRT; RevVid, Blink, Halfint, Undrln; tilt housing	80 x 25	numeric keypad	RS232, teletype protocol, 75 to 19200 baud	\$849	screen saver after 15 min., on-screen diagnostics	

PROGRAMMABLE COMMUNICATIONS TRANSLATOR



MSI's PCT-100 IS A CONFIGURABLE IN-LINE RS-232 PROTOCOL AND DATA TRANSLATOR WHICH CAN PROVIDE:

- * TERMINAL OR PRINTER EMULATION
- * DEC OR IBM SYSTEM COMPATIBILITY
- * MACRO-FUNCTION KEYS
- * "TYPE-AHEAD" AND DATA BUFFERING
- * BAUD RATE CONVERSION
- * HANDSHAKE PROTOCOL TRANSLATION (E.G. CTS/RTS, XON/XOFF)

THE PCT-100 CONFIGURATION IS EASILY ENTERED AND MODIFIED USING A BUILT-IN EDITOR, COMPILER, AND DEBUGGER. CODING TRANSLATION ALGORITHMS IS SIMILAR TO PROGRAMMING A CALCULATOR.

WITH POWER SUPPLY AND CASE, THE PCT-100 IS \$398 FOR SINGLE UNIT QUANTITIES.

Method Systems Incorporated
 19751 SOUTH LAKESHORE BOULEVARD
 EUCLID, OHIO 44119
 (216) 531-0404

CIRCLE NO. 75 ON INQUIRY CARD

Mini-Micro Systems DIRECT RESPONSE POSTCARDS

the effective, low cost advertising medium

- Sell products and services directly
- Introduce new products
- Distribute catalogs and literature
- Investigate new applications
- Develop quality sales leads

1983 POSTCARD SCHEDULE

Materials Closing Date:	2/7	4/11	8/8	10/17
Mailing Date:	March	May	Sept.	Nov.

FORMAT

Loose Card Deck / Card Size—3½" × 5½", Live Copy—3⅞" × 5⅞"

	MECHANICAL REQUIREMENTS	RATES	
		Advertisers	Non-advertisers
Negatives—right reading emul-	1 card	1350	1600
sion side down. Camera ready	2 cards	1300	1550
mechanicals—110 line screen	3 or more cards	1250	1500

CONTACT: Carol Anderson, Sales Manager
Direct Response Postcards
Mini-Micro Systems
 221 Columbus Ave.
 Boston, MA 02116
 (617)536-7780

CIRCLE NO. 76 ON INQUIRY CARD

MINI-MICRO SYSTEMS/November 1983

IF YOUR LAN IS ON A COLLISION COURSE,

CUT IT OUT.

Everybody's talking about the performance of Token Passing Local Area Networks. Western Digital has done something about them. Our NetSource/40 is a local network solution that provides the otherwise costly and complex token passing protocol in a low-cost, easy-to-use one-chip VLSI controller.

So you can design and build an efficient token passing LAN. Without writing oodles of protocol software. Without complicated interface tasks.

NetSource/40 provides a flexible, reliable bus topology for up to 254 nodes. Plus it is

- media independent
- easily prioritized
- a memory miser, with sophisticated DMA, so long messages automatically span 64 byte buffers
- speed decoupled, so it doesn't wait for, or slow down, the CPU.

So if your real-time and critical process network requirements can't cope with collisions, or if you're looking for a more streamlined, cost effective approach, plug into NetSource. Call our NetSource hotline, 714/863-7828.

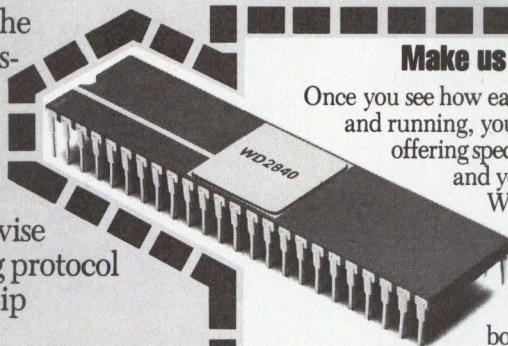

Make us your NetSource™

Once you see how easy it is to get NetSource/40 up and running, you'll be sold for certain. So we're offering special Evaluation Kits. This coupon and your check for \$195 gets you four WD2840 NetSource VLSI controllers, a helpful design Application Note, a Network Template, plus a copy of our 1983 Network Products Handbook. Limit: One kit per customer.

- Please send me more information about NetSource/40.
- Here's my check or company P.O. for \$195 (CA residents add 6% sales tax) for a NetSource/40 Evaluation Kit.
- Please bill my VISA, MASTERCARD (circle one).

ACCT. NO. _____ EXP. DATE _____

SIGNATURE _____

HOME ADDRESS _____

NAME _____ TITLE _____

COMPANY _____

ADDRESS _____

CITY _____ STATE _____ ZIP _____

PHONE _____ EXT. _____

Send to: Western Digital Corporation
Literature Dept.
2445 McCabe Way
Irvine, CA 92714

NetSource is a trademark of Western Digital Corporation

MM

WESTERN DIGITAL
C O R P O R A T I O N

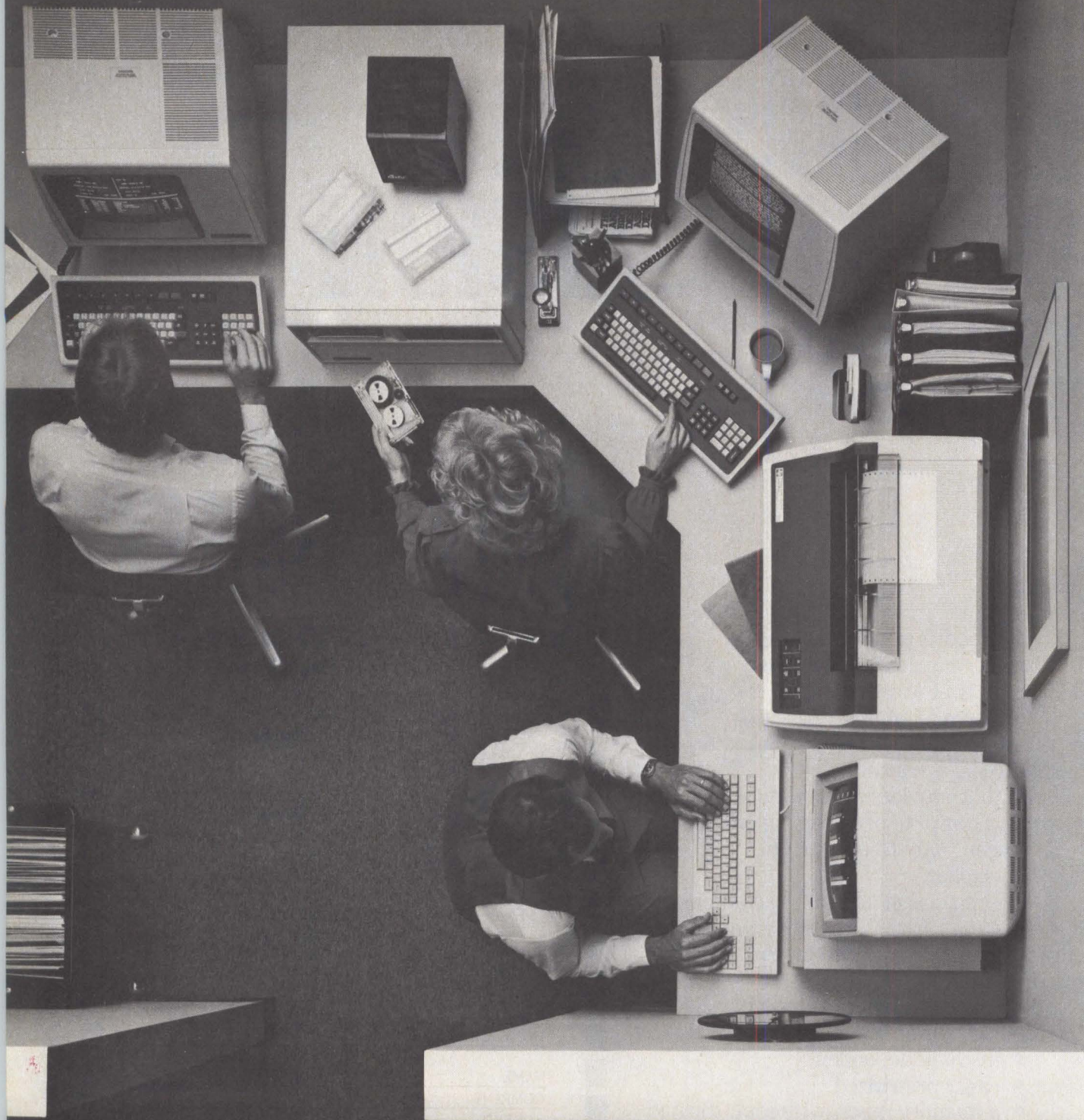

Which company should you
the most reliable computing

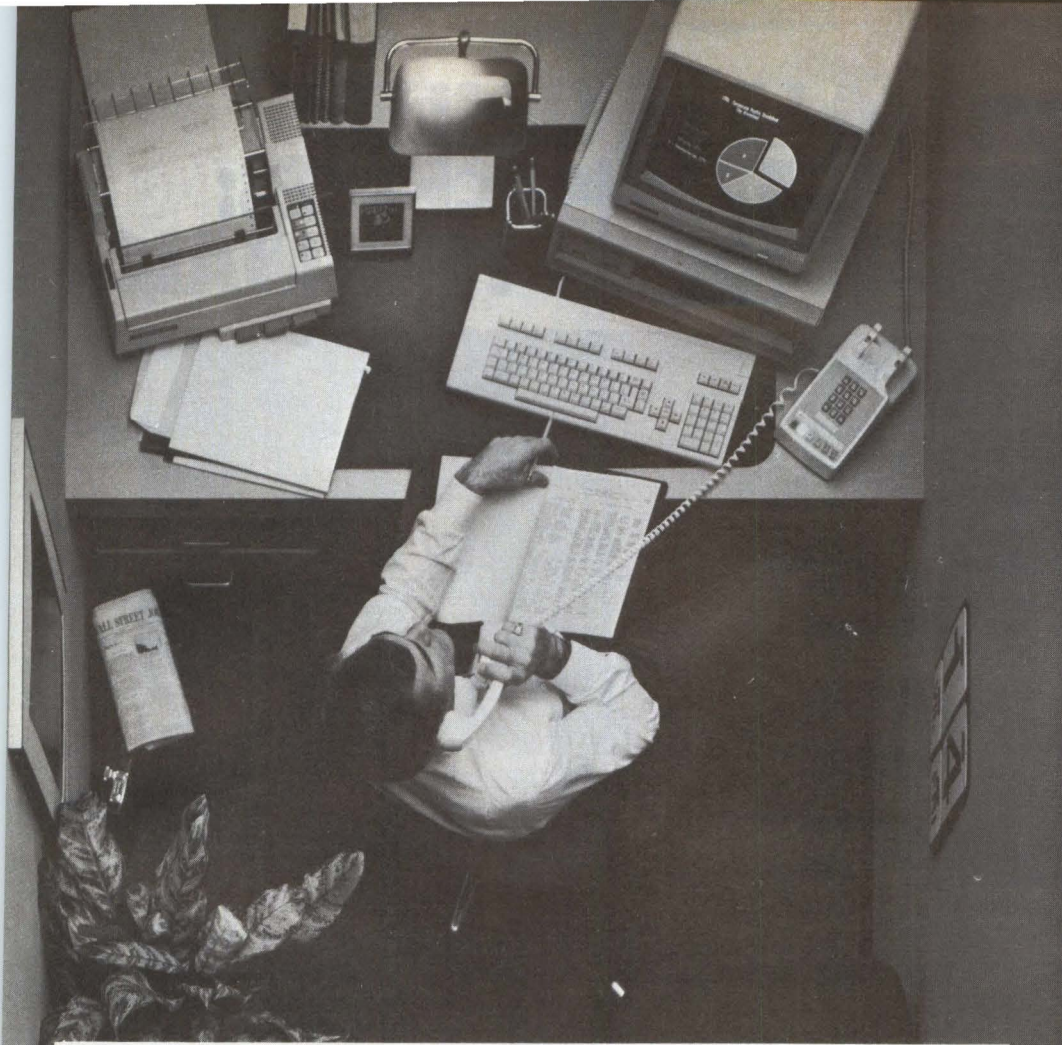

Texas Instruments. We can help you answer some tough questions about your total computing needs.

If the booklet about our complete line of reliable business and professional computing products has

been removed, we'll be happy to mail you a copy. Simply call us:
1-800-527-3500.

TEXAS 
INSTRUMENTS
Creating useful products
and services for you.

turn to for a broad range of products on the market?

PRESENTING LEAR SIEGLER'S AMERICAN DREAM MACHINES: THREE NEW HIGH TOUCH™ TERMINALS.



Have you noticed that the more high technology we put into the workplace, the more human touches the workers put in? There's a real need to soften the interface between people and high technology.

That's why we designed our new High Touch™ terminals to work together with biology, not just with technology.

Our new generation of High Touch terminals brings an elegant new touch to our American



6' coiled cable lets you put the keyboard anywhere.

Dream Machine (ADM™) tradition. The family features three new ergonomic terminals designed to meet the needs of OEMs and end users alike: The ADM 11, ADM 12 and ADM 24E.

There is more to ergonomics than simply tacking on a few fad-dish features as an afterthought. That's why we put our thinking in up front. And came up with a whole new way for terminals to relate to humans.

No aspect of terminal design escaped our deepest consideration. Or reconsideration. Dozens of little touches add up to the convenience and comfort of High Touch. For example, we put the power "on/off" switch and contrast control knob in front where they're easy to reach.

The monitor not only tilts and swivels, it stops positively in almost any position.

The clean, crisp display features a large character matrix on an easy-to-read green or amber non-glare screen—made even easier to read by the hooded bezel. Screens are available in 12" or 14" sizes.

Our uncluttered keyboard, with its logical separations between key groupings, improves your efficiency. The low-profile, DIN-standard keyboard is not only tapered, its angle of tilt is easily adjusted for maximum operator comfort.

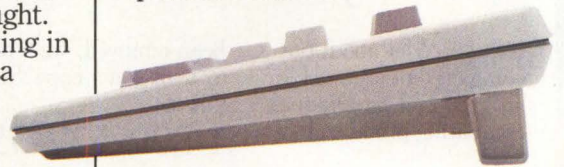

Low profile DIN-standard keyboard with adjustable tilt.

The Selectric® layout with its sculptured keys makes data entry easy and efficient. And we placed the *control* and *escape* keys close to the alphanumeric keys, where people just naturally expect to find them.

The ADM 11 is a High Touch conversational terminal that accepts data continuously at 19.2 kilobauds. It features separate cursor control keys logically arranged in a cross for ease of use. Four modes are provided for the printer interface: page print,

	ADM 11	ADM 12	ADM 24E
Programmable Function Keys	4 (Shiftable to 8)	16 (Shiftable to 32)	16 (Shiftable to 32)
Non-Volatile Function Keys	Optional	Standard	Standard
Function Key Legends on 25th Line	From Host	From Host	Standard Non-Volatile
No. of Pages of Display Memory	1	2	2 or 4
Display Memory Configurations (Plus 25th message/status line)	24 lines by 80 characters	(2) 24x80 or (1) 48x80 or (1) 24x158	User-Definable up to 96x80
Scrolling	Standard Scrolling	Smooth, Jump or Horizontal Scrolling Split Screen	Smooth or Jump Scroll Split Screen
Transmission Mode	Conversation Mode	Conversation or Block Mode	Conversation or Block Mode
Editing	Limited	Full Editing & Protected Fields	Full Editing & Protected Fields
Visual Attributes: Reduced Intensity, Blink Blank and Reverse Video. Underline also on ADM 12 and ADM 24E	3 Embedded 1 Non-Embedded	5 Embedded or Non-Embedded, plus Full Screen Reverse Video	6 Embedded or Non-Embedded, plus Full Screen Reverse Video and Highlight
OEM Flexibility	Modifiable Set-Up Characteristics	Modifiable Set-Up Characteristics & Personality	Modifiable Set-Up Characteristics. Add to Program in ROM or Down-Line Load in RAM (56K ROM or RAM. Plus up to 22K Display Available) Room for add'l Logic Boards.

line print, transparent print, and display and print. There are four programmable function keys (shiftable to eight). And two levels of setup mode to reduce errors while still giving the operator maximum flexibility.

For a High Touch terminal with editing and more, choose the ADM 12. It features five non-embedded attributes. Embedded mode can also be selected for existing applications. And 16 programmable non-volatile function keys (shiftable to 32). The display memory can be configured as two 24 x 80 character pages, or one 48 x 80 page, or one 24 x 158 page. The terminal runs in either conversational or block mode.

Or choose our top-of-the-line ADM 24E which features a moveable 24-line window you can use to look at 48 (or 96) lines of memory. The ADM 24E also offers plenty of additional space for OEMs, with up to 56K ROM or RAM available for add-on programs. Plus up to 22k display RAM.

When it comes to terminal technology, we're the historic leader with the largest installed base. Our terminals are used in

more computer-based systems than any other.

When you buy Lear Siegler, you're buying proven quality and reliability, backed by the broadest network of full service centers anywhere. That means you can get walk-in Express Depot™

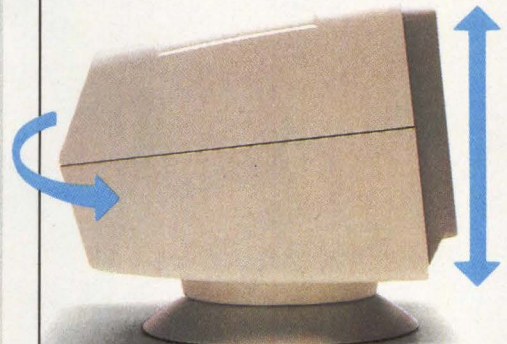

Monitor tilts and swivels to almost any position. Available with 12 or 14 inch screen.

service, on-site service and extended warranty service in 3,000 cities nationwide.

Lear Siegler High Touch terminals are made in America—designed, engineered, manufactured and shipped from Anaheim, California to provide you with the best local support.

And that's just one more reason they're called the American Dream Machines.

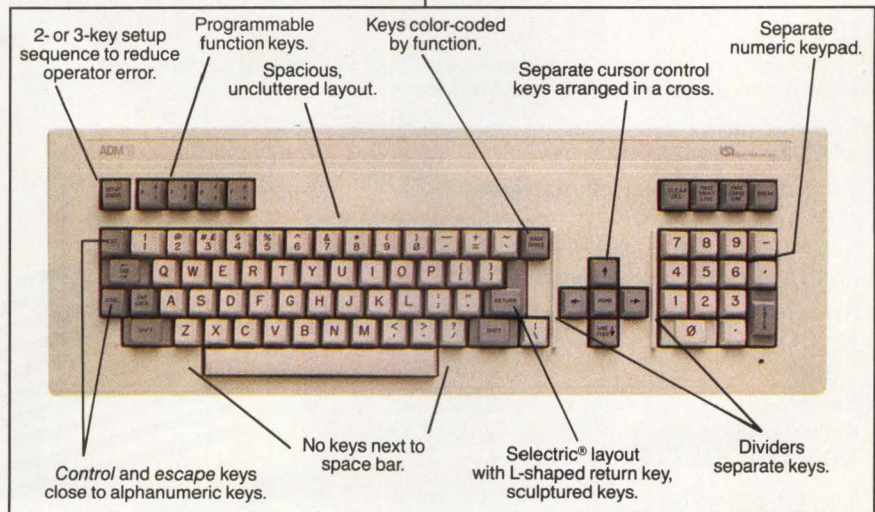

ADM 11 keyboard.



LEAR SIEGLER, INC.
DATA PRODUCTS DIVISION

901 East Ball Road, Anaheim, CA 92805 • 714-774-1010

See us at Comdex Booth #3072

EVERYBODY MAKES TERMINALS. ONLY WE MAKE LEAR SIEGLERS.

Call Lear Siegler at 800/532-7373 for an authorized distributor near you: Advanced Technology • Continental Resources • The Datastore • Data Systems Marketing • David Jamaison Carlyle, Inc. • Gentry Associates • Hall-Mark Electronics • M/A-COM Alanthus, Inc. • Marva Data Services • M.T.I. • National Computer Communications • Pioneer (Standard, Harvey, Gaithersburg) • 2M Corp. • Wyle Electronics • Kierulff Electronics • Inland Associates • Digital Source, Inc.

IF THE END USERS ARE SERIOUS, PUT THEM IN TOUCH WITH YOUR SYSTEM VIA THE LYNX

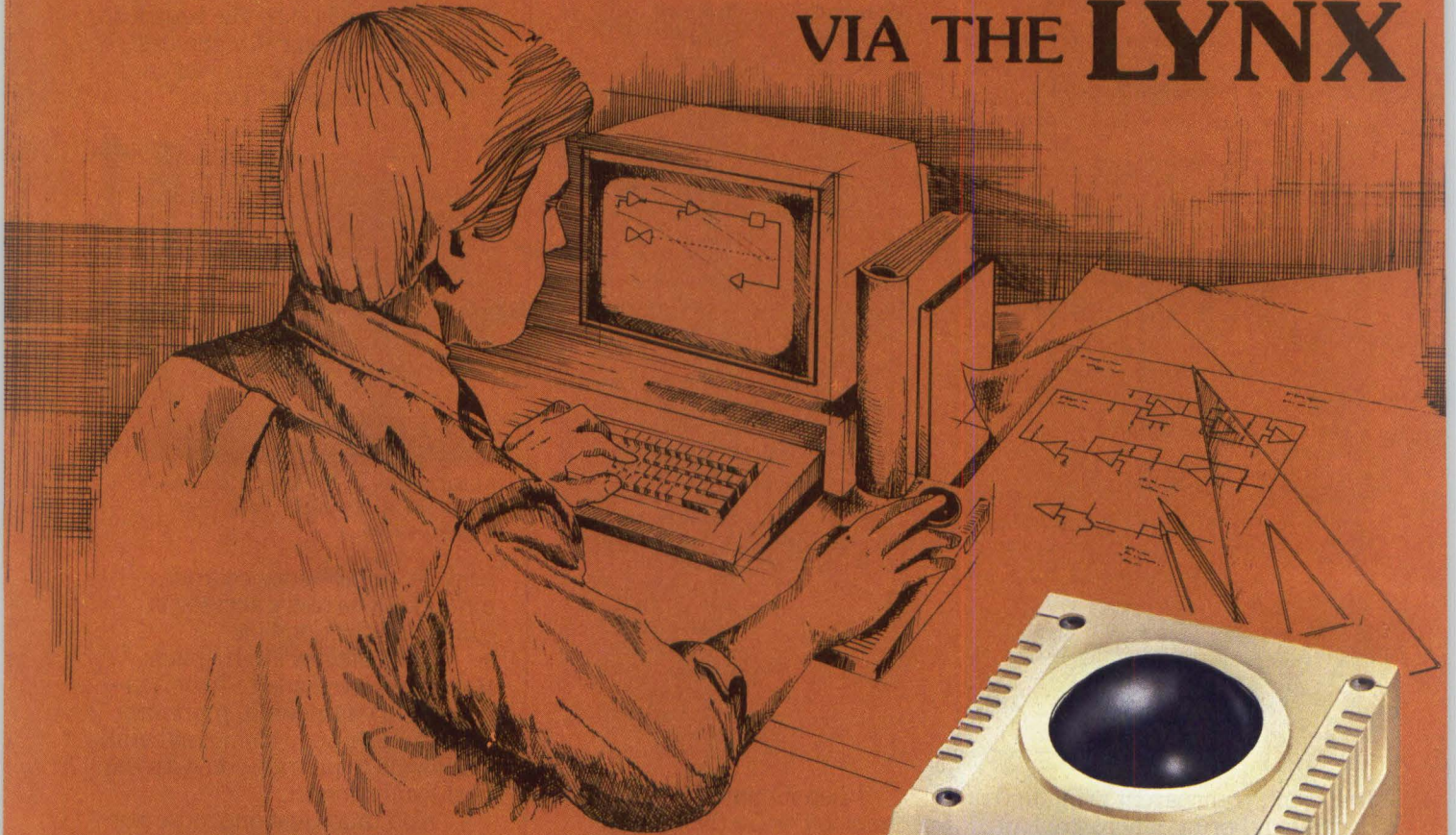

The Trackball With Nine Reasons.

- Takes up very little space on a busy desktop. No special surface required to operate on as is needed for a mouse or digital pen.
- Can be hand held or placed on any surface convenient for the user.
- Attractive, ergonomically designed housing with palm rest.
- Standard output is serial RS232C and will operate up to 100 feet from the terminal.
- No special interface box is required since there are I/O ports for RS232C available on many computers.
- Faster data output than most digital pad devices. Baud rates of 300, 600, 1200, 2400, 4800, 9600 and 19,200 can be set.
- Three user software defined pushbuttons allow maximum versatility.
- Non-contacting optical encoding provides high reliability with greater than 1,000,000 ball revolutions, X or Y axis.
- The price is right, standard units at less than \$99.00 in 1,000 quantity. Custom options available on O.E.M. quantities of 5,000 or more.



Disc Instruments
A Honeywell SUBSIDIARY

“The OEM Trackball People”

102 East Baker Street, Costa Mesa, California 92626 Telephone (714) 979-5300 TWX (910) 595-1987 Disc CSMA
CIRCLE NO. 79 ON INQUIRY CARD

COLOR TERMINALS

Using 'auto-convergence' in a color display

DAN DENHAM, BILL MEYER
and GERALD MURCH,
Tektronix Inc.

Color convergence achieved automatically

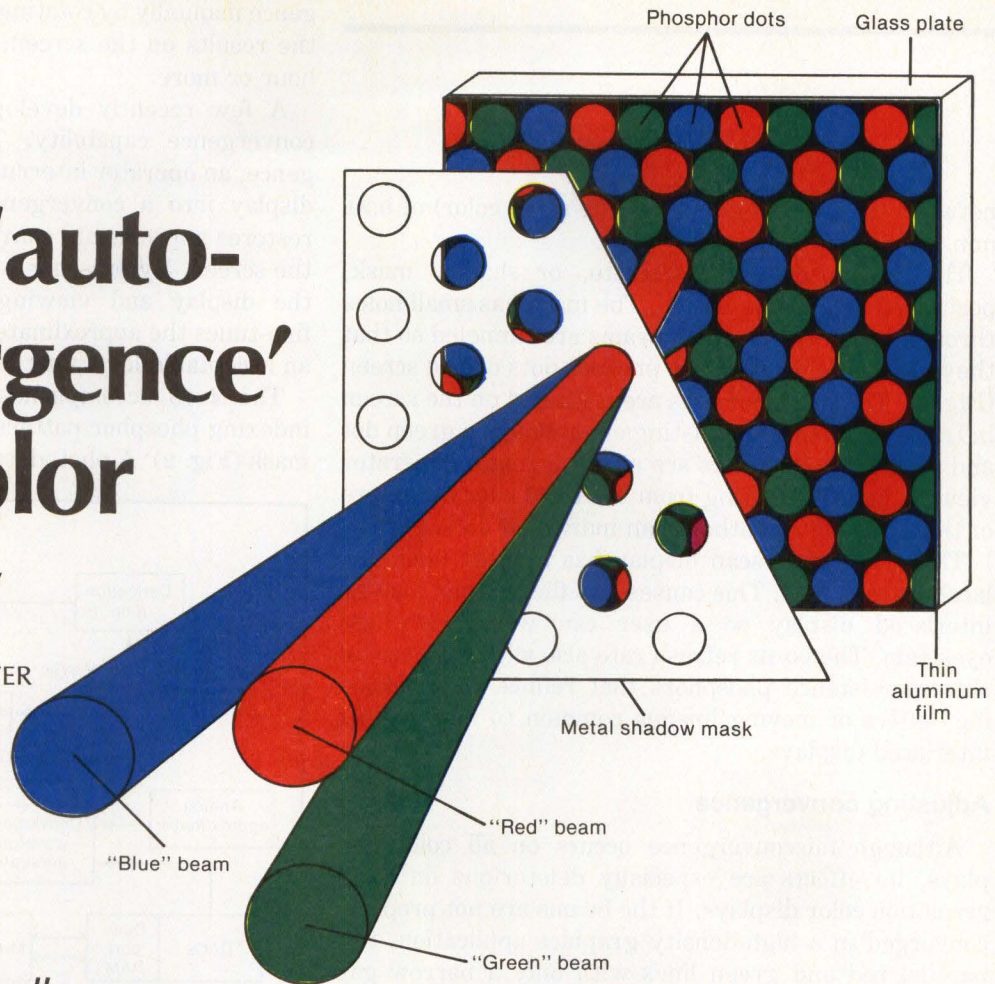

A high-resolution color display must provide sharp, true colors and precise data representation for high-density graphics applications such as computer-aided design and manufacturing and mapping. The accuracy of such a system is largely a function of resolution and color convergence. To correct misconvergence, most displays require manual (analog) or digital convergence, both of which require adjustment by a trained technician or an operator. Tektronix Inc.'s model 4115 color display, however, offers a high-resolution display with "autoconvergence" capabilities. Autoconvergence is the ability to adjust convergence automatically to the original specification anytime during an application. If convergence drifts, the operator need only press a button on the display and wait a few seconds for the system to correct the condition.

Resolution in color displays

The 4115 has a resolution of 1024 lines \times 1280 pixels. To express color resolution merely in terms of the number of lines, however, is an oversimplification. True resolution is a result of a combination of factors, including spot size, profile, pitch, refresh rate and

contrast ratio. The 4115's color beams originate from a delta gun (with two beams at the base of the gun and one on top), providing a smaller spot than is possible with an in-line gun (in which all three beams are arranged in a horizontal line). Normally, a delta gun is more difficult to converge than an in-line gun. Tektronix's autoconvergence system, however, enables convergence as accurate as that of in-line guns, while maintaining the advantage of a smaller spot.

The spot profile is a measure of the energy distribution throughout each spot on the screen. The beam energy should be as evenly divided over a spot as possible. If the spot is blurred at the edges, resolution is decreased. In the 4115, energy is distributed as evenly as possible over the pixel. To increase resolution further, the 4115 has a pitch (the vertical distance

Fig. 1. A delta-gun CRT with a shadow mask directs the electron beams associated with each of the three primary colors through holes in the mask. The phosphor dots on the screen are arranged in groups of three dots, or triads. The beams pass through the holes so that each beam excites a specific dot on the screen. The triads are small enough that, when viewed by an operator, they are perceived as a mixture of the three colors.

between the centers of dots of the same color) of 0.31 mm.

The 4115 uses a metal plate, or shadow mask, positioned behind the screen. The mask has small holes through which the electron beams are funneled so that they illuminate the correct phosphor dots on the screen (Fig. 1). The phosphor dots are arranged on the screen in triads, each triad consisting of a red dot, a green dot and a blue dot. The dots are so small that an operator viewing light emanating from the triad sees a mixture of the three colors rather than individual dots.

The 4115 raster-scan display has a 60-Hz noninterlaced refresh rate. This causes less flicker than a 30-Hz interlaced display so a user can work with less eyestrain. The 60-Hz refresh rate also allows the use of short-persistence phosphors that reduce the "smearing" effect of moving images common to many 30-Hz interlaced displays.

Adjusting convergence

Although misconvergence occurs on all color displays, its effects are especially deleterious on high-resolution color displays. If the beams are not properly converged in a high-density graphics application, two parallel red and green lines with only a narrow gap between them may appear as one thick yellow line. Thus, misconvergence could lead to serious misinterpretation of data.

Traditionally, a trained technician adjusts conver-

gence manually by rotating potentiometers and viewing the results on the screen. The procedure can take an hour or more.

A few recently developed displays offer a digital convergence capability. To perform digital convergence, an operator interrupts the application to put the display into a convergence mode. The display then restores approximate convergence and draws a grid on the screen. By pressing keys on a keypad connected to the display and viewing the screen, the operator fine-tunes the approximate convergence until it reaches an acceptable level for the application.

The 4115 accomplishes autoconvergence by using indexing phosphor patterns on the back of the shadow mask (Fig. 2). A photodetector senses the light emitted

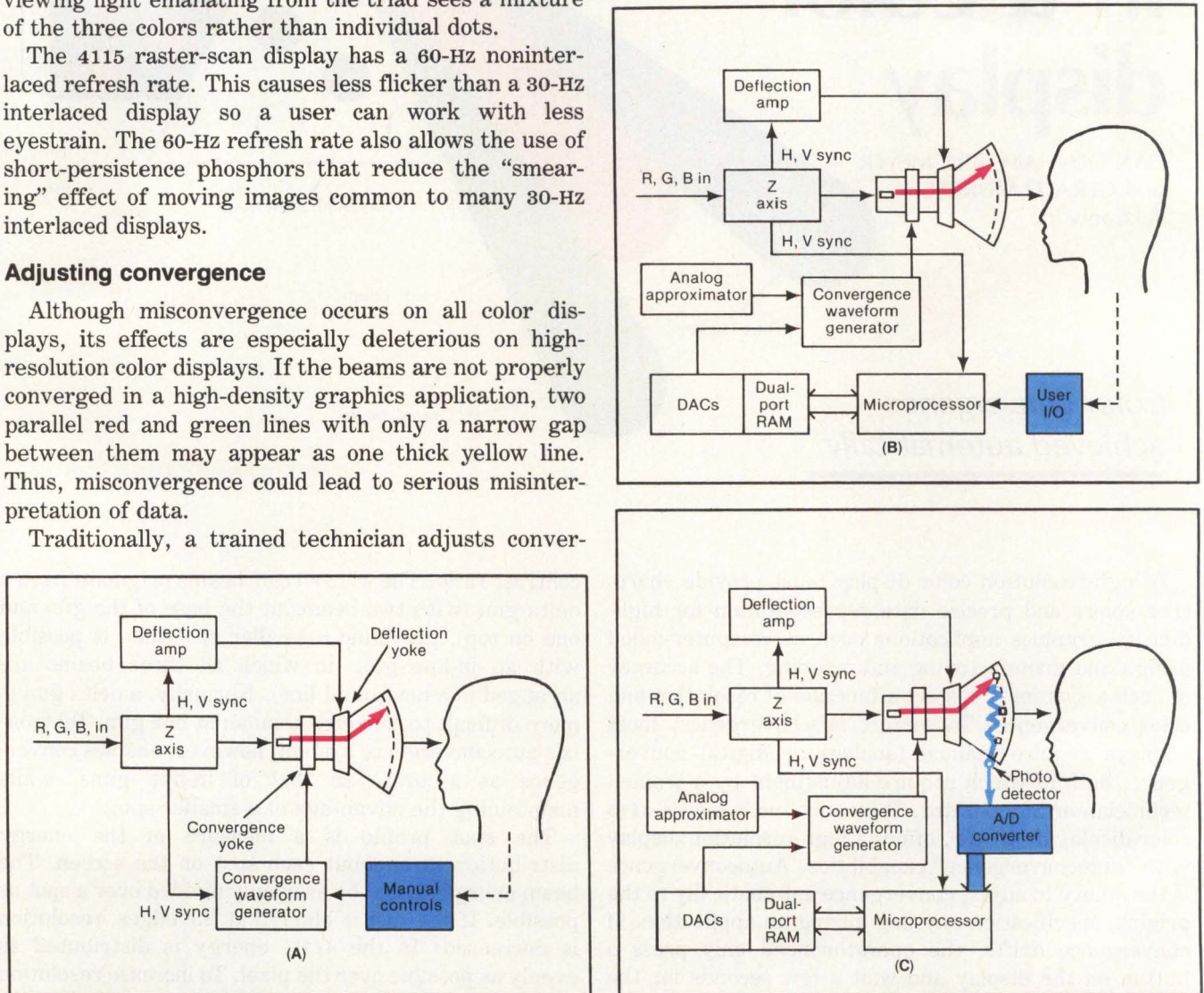
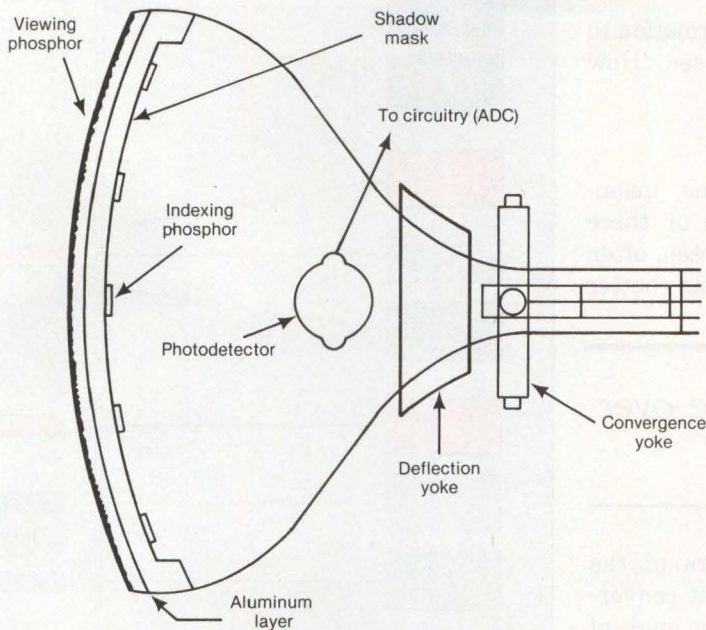

Fig. 2. Three methods of adjusting convergence. In analog convergence adjustment (A), setting the potentiometers generates a complex waveform that, when amplified, drives the convergence yoke. The yoke's electromagnetic field independently deflects each electron beam to achieve convergence. In digital convergence (B), the display is first converged at the factory. The resulting waveform is stored in dual-port RAM. During convergence, the values in RAM are fed through a digital-to-analog converter to generate the original waveform. The convergence is only approximate because it represents the condition of the new display in the factory. An operator must further adjust the convergence to account for the current condition of the display, which has been affected by such factors as temperature, age and position. Autoconvergence (C) frees the user from performing adjustment, which saves time and provides more precise adjustment. Autoconvergence uses optical feedback to sense the location of each electron beam. As in digital convergence, a complex waveform is stored in RAM in the form of digital values. By modifying these values, which are then fed through a D/A converter and amplified, the display's microprocessor can adjust the beams so that they converge within the specified range.

HOW AUTOCONVERGENCE WORKS



As the electron beams scan the screen, phosphor patterns (indexing phosphor) on the back of the shadow mask emit light back into the tube in the same way that the screen phosphors emit light to the viewer. The phosphor patterns do not block the holes of the shadow mask and have no effect on beam energy reaching the phosphor dots on the screen. An aluminum layer between the shadow mask and the screen reflects light from the phosphor dots toward the viewer and prevents errant screen light from reaching the photodetector (above figure). The phosphor patterns are deposited in locations corresponding to 13 representative convergence points on the screen.

Each phosphor pattern is shaped so that the photodetector outputs two pulses—first when the beam scans the vertical line in the pattern and again when it scans the diagonal line (Fig. A, right). Tektronix calls the phosphor patterns "lambdas," because of their resemblance to the Greek letter. The processor can determine the relative positions of the electron beams from the time difference between the two pulses. The processor adjusts the beam positions at each of the 13 locations, enabling the 4115 to maintain its convergence specification across the entire viewing area.

During autoconvergence, the pro-

cessor directs the display to turn on one electron beam at a time and receives a pair of pulses for each beam. By comparing the pairs of pulses, moving each beam individually and comparing the new photodetector output, the processor can adjust convergence. The autoconvergence procedure is complete when the pulse pairs for all three beams match within the range for the convergence specification.

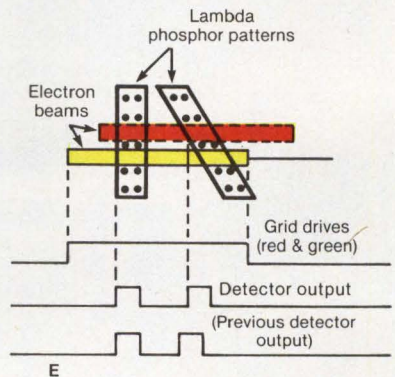
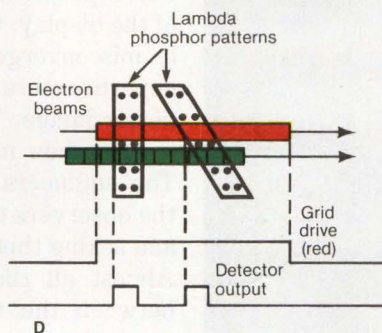
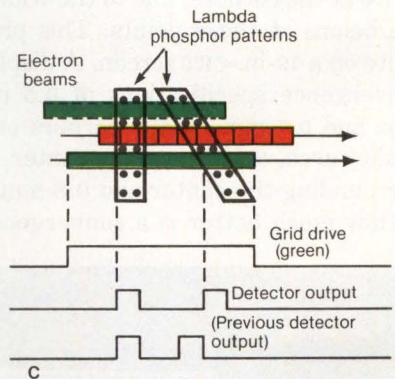
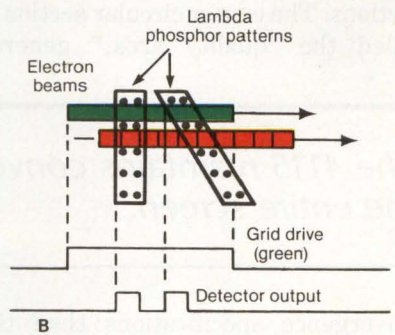
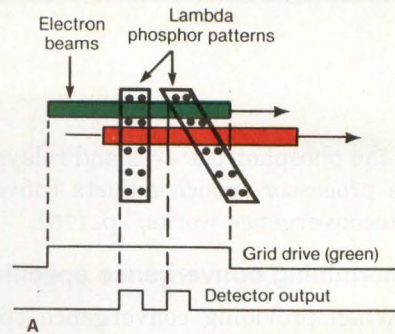

In a typical autoconvergence procedure, the green and red beams are turned on to produce a yellow line. The beams are misconverged, however, so separate red and green lines appear (A). The processor turns off the red beam to get a photodetector output for the green beam (B). By moving the green beam and comparing the new detector output with the previous pair of pulses, the processor determines the relative position of the beam (C). The processor then turns off the green beam, activates the red beam and compares the new pair of pulses with the green beam's detector output (D). The processor then computes the misconvergence and applies the necessary correction to the convergence waveform until the pulse pairs match and the beams are converged (E).

by the phosphor patterns and relays the information to the processor, which adjusts convergence (see "How autoconvergence works," p. 175).

Determining convergence specifications

When providing convergence specifications, manufacturers often divide the screen into two or three sections. The center circular section of the screen, often called the "quality area," generally boasts better

The 4115 maintains convergence over the entire screen.

convergence specifications than the corners of the screen because it is difficult to maintain tight convergence at the corners, due to the wide deflection angle of the beams at these points. This problem is especially acute on a 19-in. CRT screen. A display, then, may have convergence specifications of 0.5 mm. in the quality area and 0.7 mm. at the corners or, by shrinking the quality area, 0.3 mm. at the center, 0.6 mm. in an area surrounding the center and 0.8 mm. at the corners.

How much better is a convergence of 0.3 mm. than



The Tektronix 4115 is designed for high-density graphics and has an autoconvergence capability that automatically converges the CRT's electron beams for precise color presentation. The system is priced at \$19,500.

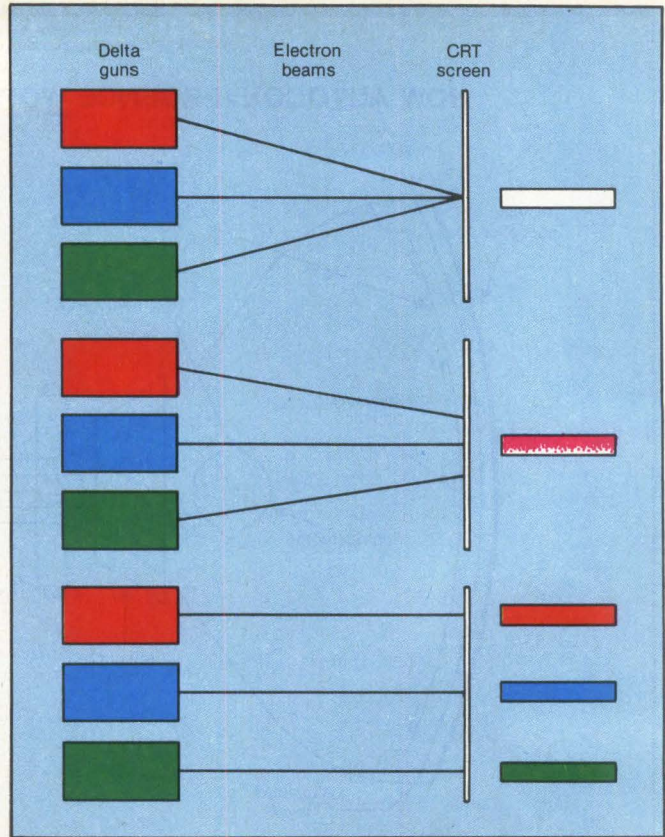

Misconvergence causes distortion of color and can result in the display of false information. When the red, blue and green electron beams are properly converged, a solid white line appears on the screen. If the beams are misconverged, the result is a thick pink line. The colors appear separately in a worst-case condition.

0.5 or 0.8 mm.? In designing the 4115, Tektronix engineers tried to answer this question by devising an experiment to find the value at which a user could no longer detect misconvergence. In the experiment, a display's screen was split in half, and two identical images were displayed. Both images initially were converged as well as possible within the technical limits of the display. One of the images was then progressively misconverged to a series of specified values. The experimenters then asked observers to choose the better image. The observers preferred the converged image when misconvergence reached 0.4 to 0.5 mm. The engineers then repeated the experiment, telling the observers that one of the images was misconverged and asking them to choose the better converged image. Almost all the subjects could detect the difference between the two images when the misconvergence reached 0.2 mm. Thus, Tektronix designed the 4115 to meet a convergence specification of 0.2 mm. or better across the viewing area of the screen. □

Dan Denham is an engineering project manager, Bill Meyer is a design engineer, and Gerald Murch is the director of the perceptual research group at the Information Display Division of Tektronix Inc., Beaverton, Ore.



**10th ANNIVERSARY
SPECIAL OFFER**

\$995

The logical switch to color has never cost less. Now you can get immediate delivery on an Intecolor 2405D single evaluation unit at the special 10th Anniversary price of \$995 (U.S. domestic only).

You'll have the advantage of vector graphics on an 80 column by 24 line screen, without sacrificing the most important capabilities you want from DEC's VT100/131 or VT220 terminals. Plus, the 2405D's eight colors convey more information, more quickly and with greater comprehension than VT100/131's monochrome.

ANSI X3.64 compatibility. The 2405D is the ideal replacement or add-on terminal. Highly compatible with VT100/131/220 and numerous other ANSI X3.64 terminals, the 2405D is easily integrated into any ANSI X3.64 environment. It includes ASCII codes and a VT52 mode. The 2405D is also compatible with Intecolor's 2427 bit-mapped color graphics terminal.

With all the features you need. Terminal based vector graphics. Data transmission baud rates from

Our ANSI X3.64 terminal has all the VT100/131 and VT220 features you'll ever need in a conversational terminal. Plus eight colors and vector graphics. Available now.

50 to 19,200. English language menu set-up mode. Non-volatile set-up memory. Two full pages of screen RAM. In-line CRT. Auto degaussing. Powerful, 6MHz 8085 CPU with four hardware interrupts. Detached keyboard. Our 10th Anniversary \$995 offer includes 12 function keys (with 36 programmable functions), normally optional. Another 12 keys are optionally available for \$100. Shipment less than 30 days after acceptance of order.

Plus Intecolor Quality. Since 1973, Intecolor has been a pioneer in high quality color graphics terminals for industrial/scientific markets. And we are continually setting new standards of reliability.

10th Anniversary price good through 1/31/84. After that, our CIRCLE NO. 80 ON INQUIRY CARD

regular single-piece price of \$1295 (100 piece: \$1075) goes into effect, and the first 12 function keys are \$95 with a total cost of \$1390. Save \$395 by acting now! Take full advantage of the color, vector graphics and ANSI X3.64 compatibility of the Intecolor 2405D at this special price.

For the name of the distributor or sales representative in your area, or for complete specs, ask about our 10th Anniversary \$995 special: **Call 1-800-241-7595.**

 **Intecolor**[®]
AN INTELLIGENT SYSTEMS COMPANY

Intecolor Drive, 225 Technology Park,
Norcross, GA 30092, TWX 810-766-1581

DOCUMENTED BUYING POWER

Mini-Micro Systems documents buying power. We've compiled a database of over 13,000 buying centers which enables us to produce two of the most comprehensive reports available anywhere.

These reports define and detail the buying activity among computer resellers (third party OEMs) and sophisticated end users. If you're competing in this market, you need to know who is buying what equipment and why. Our reports will help you. We document computer buying power. And detailed knowledge is power.

Mini-Micro Systems' 12th Annual Mini-Micro Market Report presents a collection of perspectives allowing the reader to see how computer manufacturers fare by:

- System groupings (microcomputer systems, mini systems, supermini etc.)
- Price categories
- Site penetration
- Primary vendor status (and the reasons why)

The **Mini-Micro Market Report** also includes purchasing data on:

- Fail-safe systems
- Database management systems
- Networking

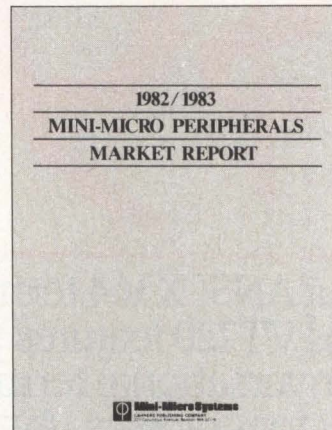
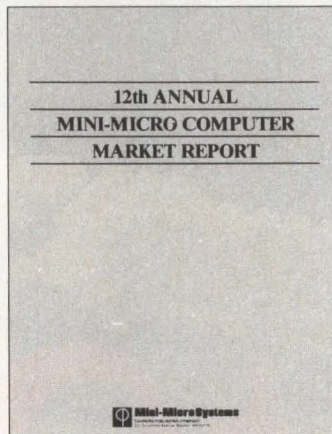

Mini-Micro Systems' Mini-Micro Peripherals Market Report covers purchasing activity of computer peripherals. This report includes:

- Disk Drives
- Printers
- Add-in Memory
- Media
 - Floppy Disks
 - Computer Tape
 - Printer Ribbon
- Tape Drives
- Terminals
- Modems
- Computer bus standards
- Computer operating systems

These reports are a must for executives marketing computer products

Please send me the following report(s).

- Mini-Micro Systems Mini-Micro Computer Market report (\$695.00)
 Mini-Micro Systems Mini-Micro Peripherals Market Report (\$395.00)
 Special offer—both reports (\$895.00)
Check enclosed Bill me

Mail to:

Publishers Office
Mini-Micro Systems
221 Columbus Ave.
Boston, MA 02116

Name _____ Title _____
Company _____
Address _____
City _____ State _____ Zip _____
Telephone _____

CIRCLE NO. 81 ON INQUIRY CARD

The Only Way
 You Can Get Q-BUS* Compatibility
 And Interface Flexibility
 With ANY or ALL These
 5¼" Winchester Drives
 is With
 These Two Controllers

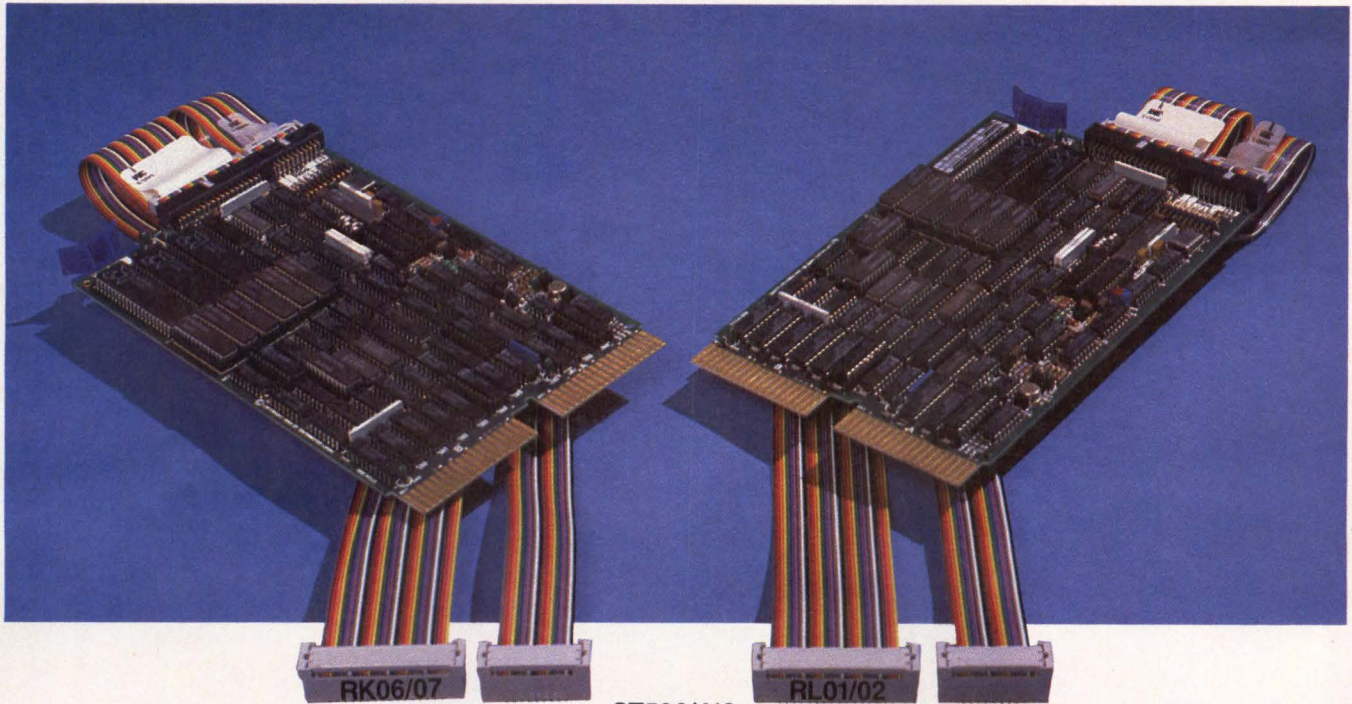

AMPEX	FUTITSU	MINISCRIBE	SEAGATE
ATASI	IMI	MPI (Micro Peripherals)	SHUGART
ATHENAEUM	MAXTOR	NEC	SYQUEST
CDC	MEMOREX	NISSEI SANGYO	TANDON
CMI	MICROPOLIS	PRIAM	TOKYO ELECTRIC
COGITO	MICROSCIENCE	QUANTUM	TULIN
DISCTRON (RMS)	INTERNATIONAL	RODIME	VERTEX

THE ONLY WAY!

You can't get it with DEC. Or any other independent controller manufacturer.

That's because these controllers feature DILOG's exclusive Universal Formatting™. That means you can mix or match any two compatible drives (ST506/412), regardless of heads, parameters, capacity, etc. This powerful feature offers you real flexibility in drive selection now...and expansion in the future. It's simple as unplugging one drive and plugging in another.

Model DQ615

- RK06/07 compatible
- Formatted drive capacities 222.4 MB
- Maximum 8 logical units—two physical

Model DQ614

- RL01/02 compatible
- Formatted drive capacities 41.6 MB
- Maximum 4 logical units—two physical

They both have enhanced 32-bit ECC, 22-bit addressing and RT-11, RSX-11, RSTS and TSX-Plus.

DILOG Universal Formatting™ is also offered for the largest SMD I/O drives. And for your back up there are controllers for ½" tape, ¼" cassette and 5¼" and 8" floppy drives.

Contact your nearest sales office, distributor or DILOG directly for complete data on the way to unmatched Q-BUS compatibility and drive flexibility... THE ONLY WAY!



DISTRIBUTED LOGIC CORPORATION

12800 Garden Grove Blvd. ■ Garden Grove, CA 92643 ■ (714) 534-8950 ■ TLX 681399

64-A White Street ■ Red Bank, NJ 07701 ■ (201) 530-0044

12 Temple Square ■ Aylesbury, Buckinghamshire, England HP 20 2QL ■ 44 (0296) 84101 ■ TLX 837038



Speed. Convenience. Productivity. All good intentions. All up in smoke. All because too many personal computers proved too much of a good thing. And caused problems for your people. Incompatible programs, inaccessible information, inconsistent data, uncoordinated efforts. But we can put out all those fires with our Integrated Personal Business Computer. Because our IPBC contains all the hardware and software you need to combine the convenience of personal computing with the power of your corporate data base. With our IPBC, your people can access all the complete, consistent information in your corporate computer and use it in their personal computers. And vice versa. Without rekeying. Without errors. And without giving up their favorite programs. Because, as a 16-bit personal computer, our IPBC runs the new MS-DOS™ based programs for the IBM-

The road to hell is paved with good intentions.

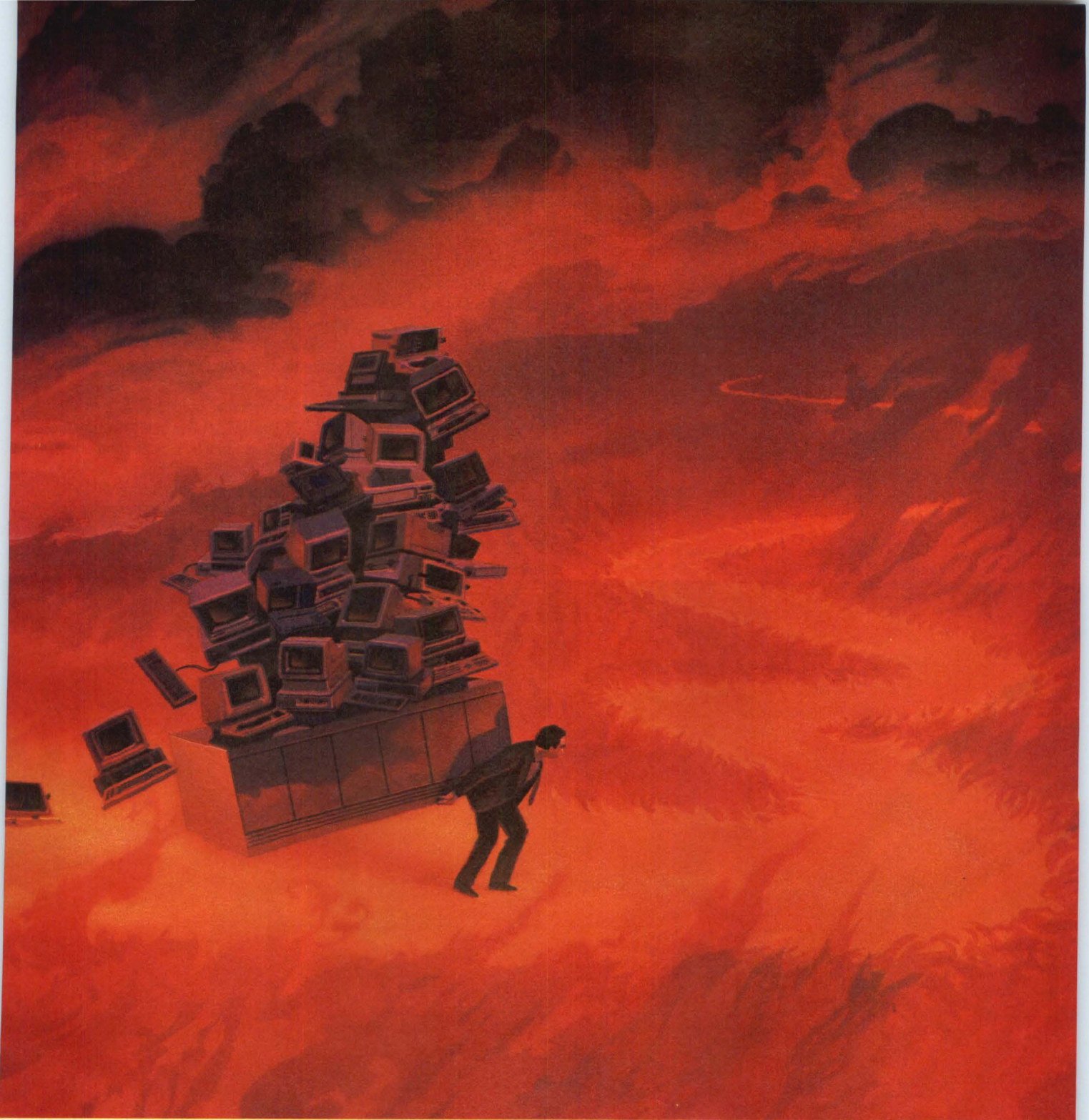

PC.[™] Right off the shelf. And it runs all the popular CP/M[®]-based programs too.

Then at the touch of a button, the IPBC becomes a terminal that lets your people run programs on most host computers, including IBM, DEC and HP.

Which means that with just one piece of hardware from one supplier, you can give everybody what they expected from personal computing. And what you expect from your

See us at Comdex.
Booth #477



corporate MIS investment.

So call Direct at (408) 980-1414, extension 315. Or write us at 4201 Burton Drive, Santa Clara, California 95054. We'll show you how to travel the road to Integrated Personal Business Computing.

Without getting burned.

DIRECT

THERE ARE AT LEAST EIGHT MORE TERMINALS HIDING IN YOUR VAX.

All you need is one Able VMZ/32 asynchronous terminal controller to find 8 more lines in your DEC VAX-11/730, /750 or /780, for a total of 16. With an additional VMZ/32 you can discover 16 more lines.

The VMZ/32 board plugs into the same space as the standard DEC DMF32 board it replaces, providing 16 lines instead of 8. Without patches to the VMS. And with complete VMS compatibility.

Immediately you'll unleash a minimum 13% increase in processing speed. You'll instantly realize a 50% reduction in costs per line, obtain a 50% space savings in the backplane and see a surprising reduction in power consumption.

The VMZ/32 also reveals hidden performance within your CPU by increasing its availability (idle time) up to 500%.

To handle this newly acquired power, the VMZ/32

gives you modem control on all sixteen lines. This lets you easily manage the terminals, including those remotely located. Plus, you can easily vary the speed on each line from a 50 to a 19.2K baud rate, including split baud capability.

Here's a dependability clue: an MTBF of over 100,000 hours. To back it up, the VMZ/32 comes with a one-year warranty from Able that can be extended if you like. Ask your Able representative for full details.

If you do unearth a problem, Able Support Service is as close as the phone.

You can also uncover extra performance hidden in your printer with Able's VMZ/LP. The VMZ/LP provides a dramatic reduction in CPU overhead and is LPI1 cable compatible.

So, to discover the full potential hiding in your VAX, Able's got a simple solution: just plug in the VMZ/32.



The communications specialists.

CIRCLE NO. 84 ON INQUIRY CARD

1732 Reynolds Avenue, Irvine, California 92714. Call toll free: 800-332-2253. In the Irvine area: (714) 979-7030. Or, TWX: 910-595-1729

DEC, VAX, DMF32 and VMS are trademarks of Digital Equipment Corporation.

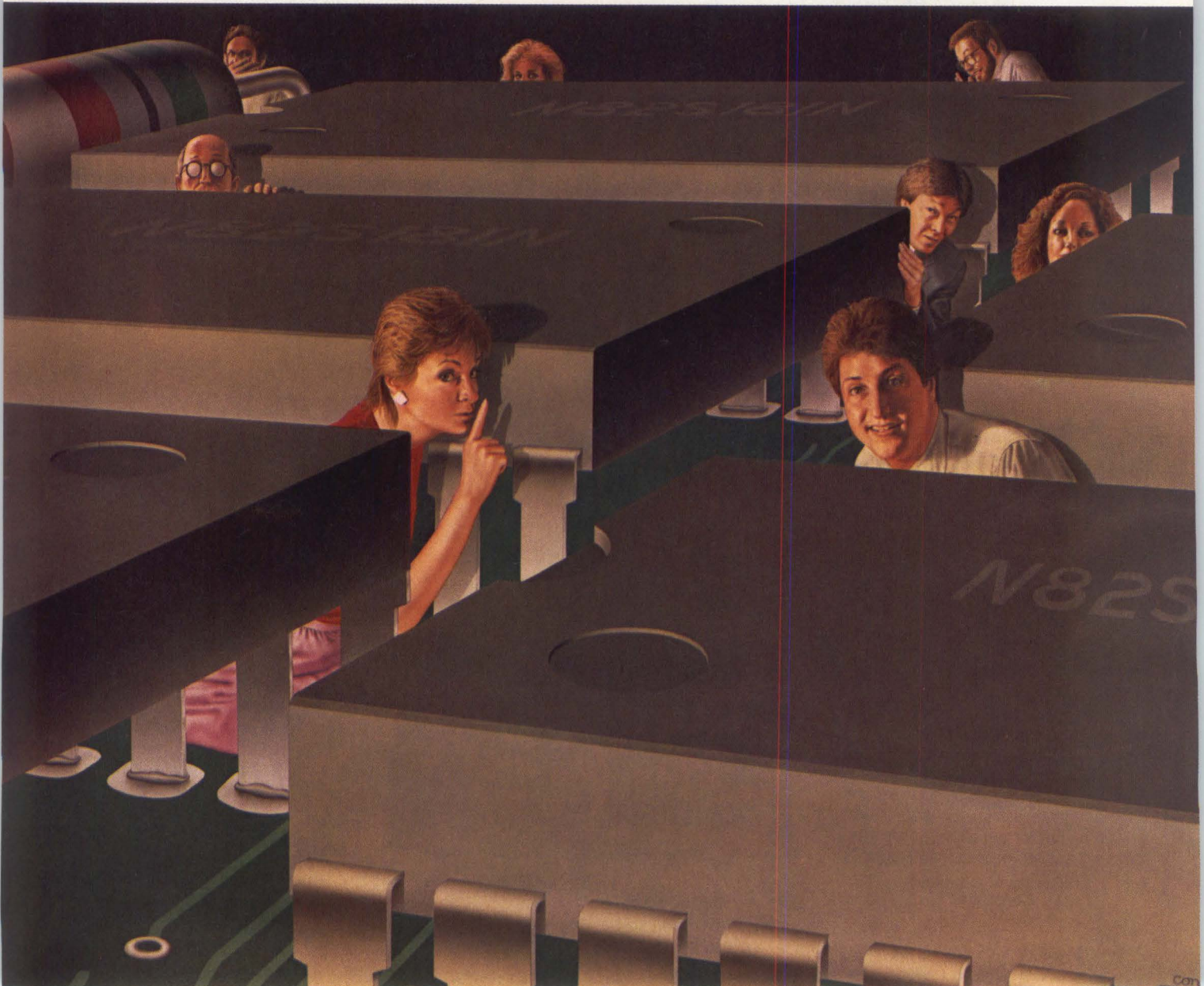

Implementation strategies for voice-processing terminals

JOE NANCE, Votan

Multichannel, multifunction voice utility combines major speech technologies

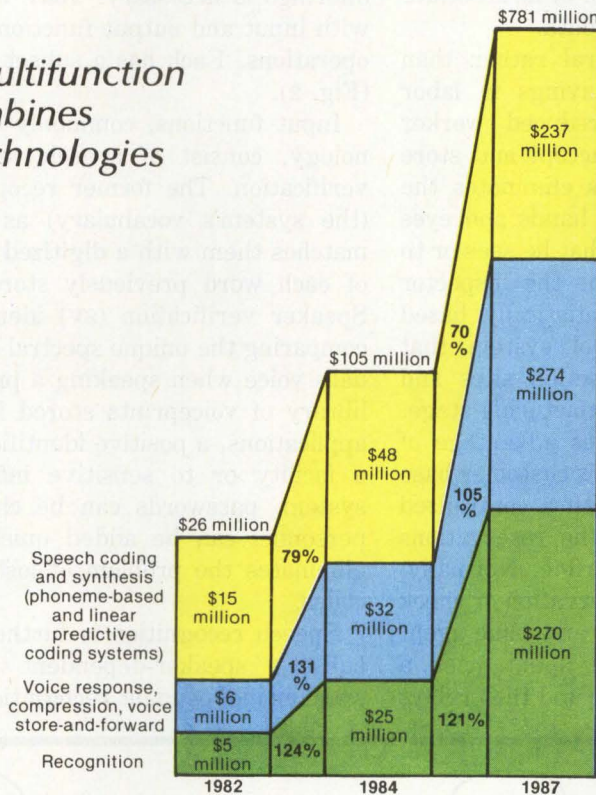

Fig. 1. Compound annual growth rates for the major categories of speech-processing products. Speech-recognition system sales will increase more than 50-fold, while the total market is projected to increase 30-fold.

Source: International Resource Development Inc.

The market for digital speech-processing products is projected to increase from \$26 million in 1982 to more than \$780 million in 1987. A key concern for speech-product vendors and system integrators is how to introduce and implement voice technology for end users. A system integrator can implement voice technology in a planned, three-stage approach that allows migration from a single-application system to one that encompasses both company-wide and external use.

Why voice terminals?

Human beings communicate with computers and other high-order machines in ways that usually require special training or skill. Voice technology addresses the need for a more "human" man/machine interface. The ability to use speech to command the activities of a computer or computer-controlled machine and to have

that machine respond with speech output provides a terminal that truly lives up to the overused descriptor "user friendly."

The banking, retailing, manufacturing and transportation industries have recognized the benefits of using voice-processing terminals. Users of voice-based transaction systems require little training. The systems are convenient to use: speech allows a user to enter data faster and more accurately because it eliminates the use of transcription and intermediate processing steps. This translates into lower error rates, improved blue- and white-collar productivity and cost savings. As a result, the market for voice-technology products is projected to more than double each year for the next four to five years (Fig. 1).

The market for speech-processing terminals falls into two generic application areas: "busy hands/busy eyes" and remote transaction processing. Busy-hands/busy-

eyes situations are typically those in which an operator must interrupt a primary activity to enter or read other information. A prime example is the use of scientific instruments in manufacturing such products as semiconductor wafers. An inspector uses a high-power microscope to inspect chips for defects. The integrated-circuit (IC) inspector notes the type, nature and most likely source of the defect. The inspector or an associate must then compile and transcribe the data.

A voice-input terminal allowing oral rather than written notes provides significant savings in labor costs, increased productivity and reduced worker fatigue. A voice system tailored to accept and store verbal information about chip defects eliminates the need for the IC inspector to take his hands and eyes away from the microscope to record what he sees or to have another person to take notes as the inspector works. This allows creation of a statistically based real-time data-acquisition and control system that immediately flags problems at inspection sites and initiates corrections at an earlier manufacturing stage.

Remote transaction processing takes advantage of telephone terminals so that a company's customer base or mobile sales force can interact with a centralized information system. An example is the reservations and information system of a major airline. Normally, when a customer wants to make a reservation or check flight availability or air fares, he calls an airline agent and requests the information. The agent uses a computer terminal to query a database and then relays

the information to the customer. By having a voice-processing terminal "answer" the phone, the caller can talk directly to the airline computer system, eliminating the intermediary. In the same fashion, a field salesperson can call the computer and place orders, check inventory status or confirm shipping dates 24 hours a day without interrupting office personnel and without concern for time differences.

Voice-processing comprises many technologies

To understand the implications of speech-processing terminals, familiarity with the basic technological offerings is necessary. Voice technology is concerned with input and output functions as are other terminal operations. Each has a subset of distinct technologies (Fig. 2).

Input functions, commonly called recognition technology, consist of speech recognition and speaker verification. The former recognizes particular words (the system's vocabulary) as they are spoken and matches them with a digitized "template," or pattern, of each word previously stored in system memory. Speaker verification (SV) identifies an individual by comparing the unique spectral qualities of that individual's voice when speaking a prescribed password to a library of voiceprints stored in memory. In security applications, a positive identification permits access to a facility or to sensitive information. With an SV system, passwords can be changed, and authorized personnel can be added quickly and easily. It also eliminates the problem of lost card keys and broken codes.

Speech recognition is further characterized by two subsets: speaker-dependent recognition (SDR) and speaker-independent recognition (SIR). SDR recognizes

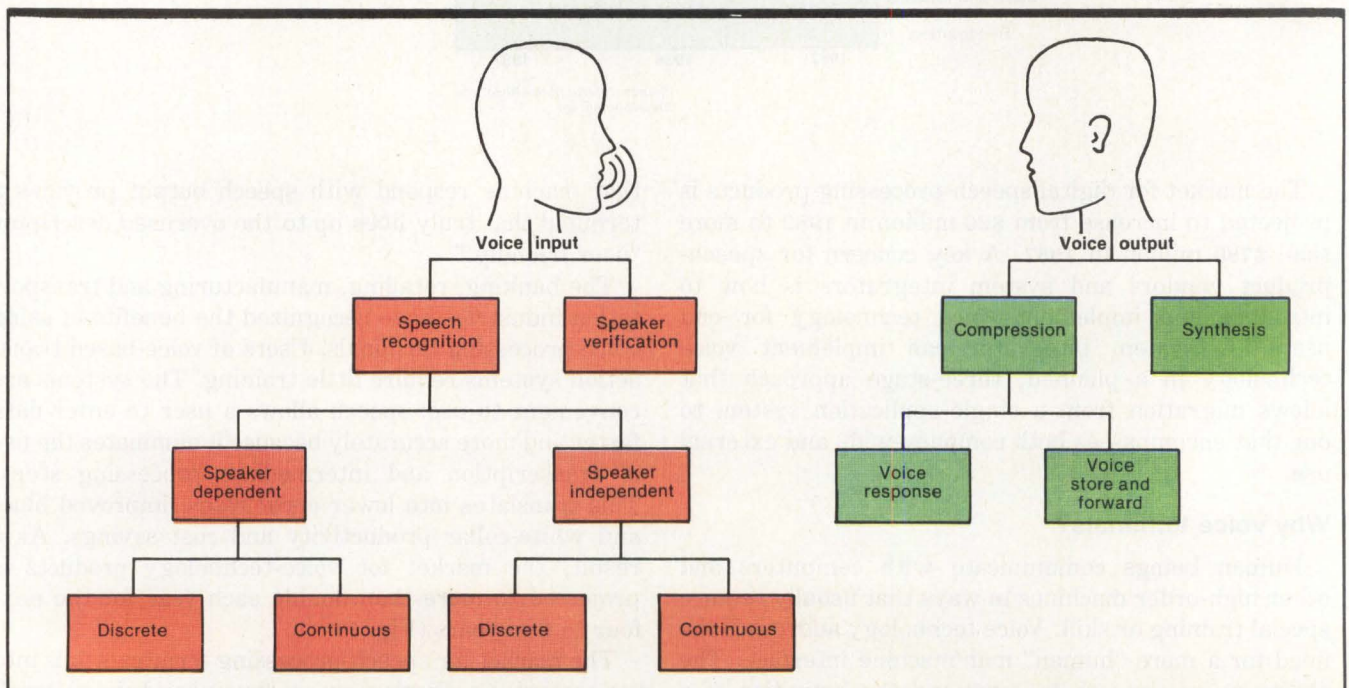
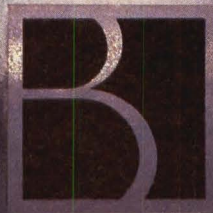

Fig. 2. Voice technology can be divided into two main areas: input and output. Most current research is aimed at developing a system that combines speaker-independent, continuous-speech recognition and compressed voice response.



DISCOVER BRIDGE COMMUNICATIONS.

The High-Performance LAN Source.

Information and computer equipment. Two of your most valuable resources. But even more important is making those resources available to the people who need them most.

We're Bridge Communications. And we've developed the first commercially available 68000-based Ethernet local area network systems to make that goal a reality.

Simply and efficiently.

Take our CS/1, for example. This high-performance communications computer can be configured to support a comprehensive, resource-sharing, local area network. Its multiple 68000 microprocessor architecture provides unmatched performance levels (up to 200 packets/s). And CS/1 software fully implements Xerox Network System high-level protocols.

In complex multivendor environments, each CS/1 can network up to 32 of the most common RS-232 equipped computing and communications devices, including printers, terminals, personal computers, modems, disk systems, minicomputers and mainframes.

Even if they were never designed to be networked.

The CS/1 can also function as a front-end processor linking multiple host systems. As a terminal concentrator. Or as a peripheral cluster controller.

But that's just the beginning. At Bridge, we're continually discovering new ways to improve information management. For more information on the CS/1, or any of our other high-performance Ethernet systems, call us at (408) 446-2981.



Bridge Communications Inc.
10440 Bubb Road
Cupertino, CA 95014
Tel: (408) 446-2981
Telex: 176 544
Boston (617) 890-6122
Washington D.C. (202) 429-2042

CIRCLE NO. 85 ON INQUIRY CARD

a word or phrase spoken by an individual who has trained the system by entering a set of vocabulary words. In training, the voice system digitizes and creates a template of each word and stores the templates in system memory. In operation, the voice system digitizes a spoken word and compares it to the stored templates. If they match, the word is recognized. SDR offers large vocabularies of as many as 255 user-selectable words and can be constructed in any language. On the other hand, SIR replaces user training with a set of representative templates created from a statistical sampling of a large population base, accounting for differences in speech accent, tonality and speed. In operation, a user can speak designated words and have them recognized without having trained the system. With SIR, however, the vocabularies are limited, preselected by the vendor and restricted to the language in which they were developed.

Another distinction in speech recognition is between discrete word and continuous recognition. Discrete-recognition systems, by far the more common and cost-effective of the two, recognize 1- to 2-second-long words or short phrases. Continuous-speech systems recognize long strings of words without pauses between the words. The ultimate objective of voice technology vendors is to develop speaker-independent, continuous-speech recognizers with unlimited vocabularies.

Voice output also is split into two approaches. Voice compression is based on the digital representation of actual human speech, which is compressed by coding redundant speech elements. Speech synthesis, on the other hand, constructs words from their building blocks, called phonemes. The system vocabulary is usually built around a tight set of phonemes, thereby significantly limiting the vocabulary size as well as introducing language dependencies. In operation, the reconstructed words are the direct product of a machine and typically sound robotic. Digital voice compression, on the other hand, is derived from a human source and retains the mood, emphasis and tone of the original speaker. Digital voice compression enables output messages to be easily modified in the field and to be created in any language.

Voice compression can be further distinguished as voice response (VR) or voice store and forward (VSF). VR is the audio output of a digitized and stored message of any length. It is used for operator prompting, feedback, information retrieval and interactive conversations using static messages. VSF is the real-time encoding and compression of a verbal message for temporary storage and subsequent retrieval as in voice mail or for immediate transmission to a listener's terminal, at which it is reconverted to audio output. VSF provides the technical basis for large multiuser telephone-answering and message-distribution centers.

Voice utility directs traffic

Voice-processing capabilities can be implemented in any terminal, computer or workstation. A board set that handles both recognition and compression provides

HOW SPEECH IS RECOGNIZED

Most speech-recognition techniques are either phoneme based or digital pattern-matching algorithms. Phoneme-based systems are algorithms designed to parse an incoming utterance into its smallest distinct sounds (phonemes) and compare the phonemes to those stored in a library of known words. Digital pattern-matching algorithms digitize incoming analog signals and compare the digital patterns of the incoming word to word patterns stored in system memory. If the incoming pattern matches a pattern on file within a specified tolerance, the incoming utterance is then "recognized."

To convert the analog signals to digital signals, the Votan system uses a proprietary algorithm that resembles a Fast Fourier Transform (FFT). A template is then made from the digitized frequency data and is stored in memory. This is called "voiceprint encoding."

To "recognize" a word, the voice processor constructs a "token" of the incoming utterance. The token-building algorithm is almost identical to the process used to build a template. The algorithm compensates for speech variances and matches the tokens to the templates by comparing the "distance" between the token and each of the templates on file. The distance scale goes from 0 (a perfect match) to 255. The template with the

lowest distance is declared to match the token, provided the distance is below a pre-defined threshold. Setting a threshold prevents random noise, or words not on file, to be mistaken for words that are on file.

This technique applies to speaker-dependent recognition (SDR) as well as to speaker-independent recognition (SIR). The Votan system has a vocabulary of 255 words in SDR operation and 12 words in SIR mode.

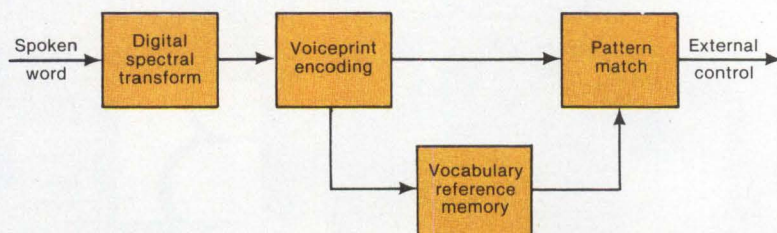

The best buy in smart terminals just got better.

At a \$495 single-unit price, the Freedom™ 100 Video Display Terminal* beats the competition hands down. Because if they've got the features, they can't compete on price. And if they've got the price, they sure don't have the features. Whether it's



TeleVideo 925, Esprit II, QVT 102 or any other comparable VDT.

Just check the table. Then call Liberty. We're committed to being number one in price/performance.

And that means making the best you can buy, a better buy.

Standard Features (Source: Manufacturer Catalogs)	Liberty Freedom™ 100	Esprit Systems Esprit II	Qume QVT 102	TeleVideo 925
Dot Matrix	7 x 9	7 x 9	7 x 9	7 x 8
25th Status Line	✓		✓	✓
Video Attributes By Character	✓		✓	✓
Attributes Req No Display Space	✓	✓		
Line Drawing Character Set	✓		✓	
Screen Tilt	✓		✓	✓
Buffered Printer Port	✓			
Separate Function Keys	10	0	4	11
Insert/Delete Line Key(s)	✓	✓	✓	✓
Erase End of Line/End of Page Key(s)	✓		✓	✓
Print Key	✓		✓	✓
Block Mode	✓	✓	✓	✓
Standard Foreign Characters	✓			✓
Local Mode	✓	✓	✓	

BOOTH 5635 MINI-MICRO NOVEMBER 8-11

 **LIBERTY**

Liberty Electronics
625 Third Street
San Francisco, California 94107
(415) 751-7560

The ABM-83 delivers a lot more features for a lot less money



**\$300.00
LESS**



*The ABM-83 is truly your best choice for
a versatile and highly productive business terminal that
costs \$300.00 less than the competition.*

Why pay more to get the code compatibility of a TVI 920 or 925 when you have a better choice... the ABM-83!

Not only does the ABM-83 offer far more features essential in day-to-day data entry and word processing tasks than the 920 or 925, but the ABM-83 provides designed-in end-user ergonomics better suited for a highly productive business environment. Our crisper, high resolution display dramatically reduces eye fatigue and our humanly engineered keyboard with sculptured keys provides for greater operator ease and productivity. Standard

with the ABM-83 are 24 user-programmable function keys (non-volatile memory optional).

In addition to the ABM-83 shown, ask about the unique ABM-85H that offers user selectable embedded or non-embedded attributes, 93 graphics and 4 international character sets: all set-ups, 16 programmable function keys and programmable answerback stored in non-volatile memory; up to three pages of additional display (optional), as well as all of the great advantages of the ABM-83. (Third party service by RCA.)

Kimtron

(408) 727-1510

2225 I Martin Avenue • Santa Clara, CA 95050

DISTRIBUTOR & DEALER INQUIRES INVITED

CIRCLE NO. 87 ON INQUIRY CARD

VOICE TERMINALS

a dedicated voice channel for each terminal. However, a more flexible and cost-effective approach is to use a central voice utility that concurrently manages the requirements of many users, serving as the link between a company's communications and information-processing systems. In this approach, a central voice utility, accessed through the PABX, links with the local-area network (LAN). Both local (internal) and remote (external) users can access the voice utility through any phone terminal (Fig. 3).

To handle a full range of applications, the voice utility offers all the major speech technologies (SDR, SIR, SV, VR, VSF) in an integrated configuration sharing hardware and software. Most applications benefit from the use of voice input and output in combination, which provides prompting, feedback and interactive conversations between users and computers. Applications such as voice mail, dictation, word processing, executive information inquiry, field sales-order entry, customer service and other functions can run concurrently.

In a typical sales organization, for example, a salesperson calls the computer system by phone. The call routes through the PABX, voice utility and LAN,

establishing a two-way conversation with the computer system. Through the voice utility, the computer responds with *Hello. What can I help you with today? The following functions are available: order entry, inventory control and customer evaluations. At the sound of the tone, please select the desired function by name.* On choosing order entry, the salesperson then hears the options associated with that function and processes the customers' orders. With the multichannel voice utility, other sales personnel can access the system concurrently. Personnel at the home office or field staff can also place these calls. The voice utility accepts voice inputs, interprets their meaning and communicates with the host processor by using the protocol of the LAN and conforming to the data-message protocol of the host processor.

The voice processor converts speech signals from analog to digital and compares them to digitized word patterns stored in system memory. A proprietary digital spectral transform performs the conversion from the time domain to the frequency domain. The Votan transform is an algorithm that closely resembles a Fast Fourier Transform (FFT). Most of the mathematics involved in this transform are "reversible" for use in voice generation as well as voice recognition.

The voice utility also accepts the appropriate data from the host processor and converts it to an audio message that is output to the user. In all cases, the

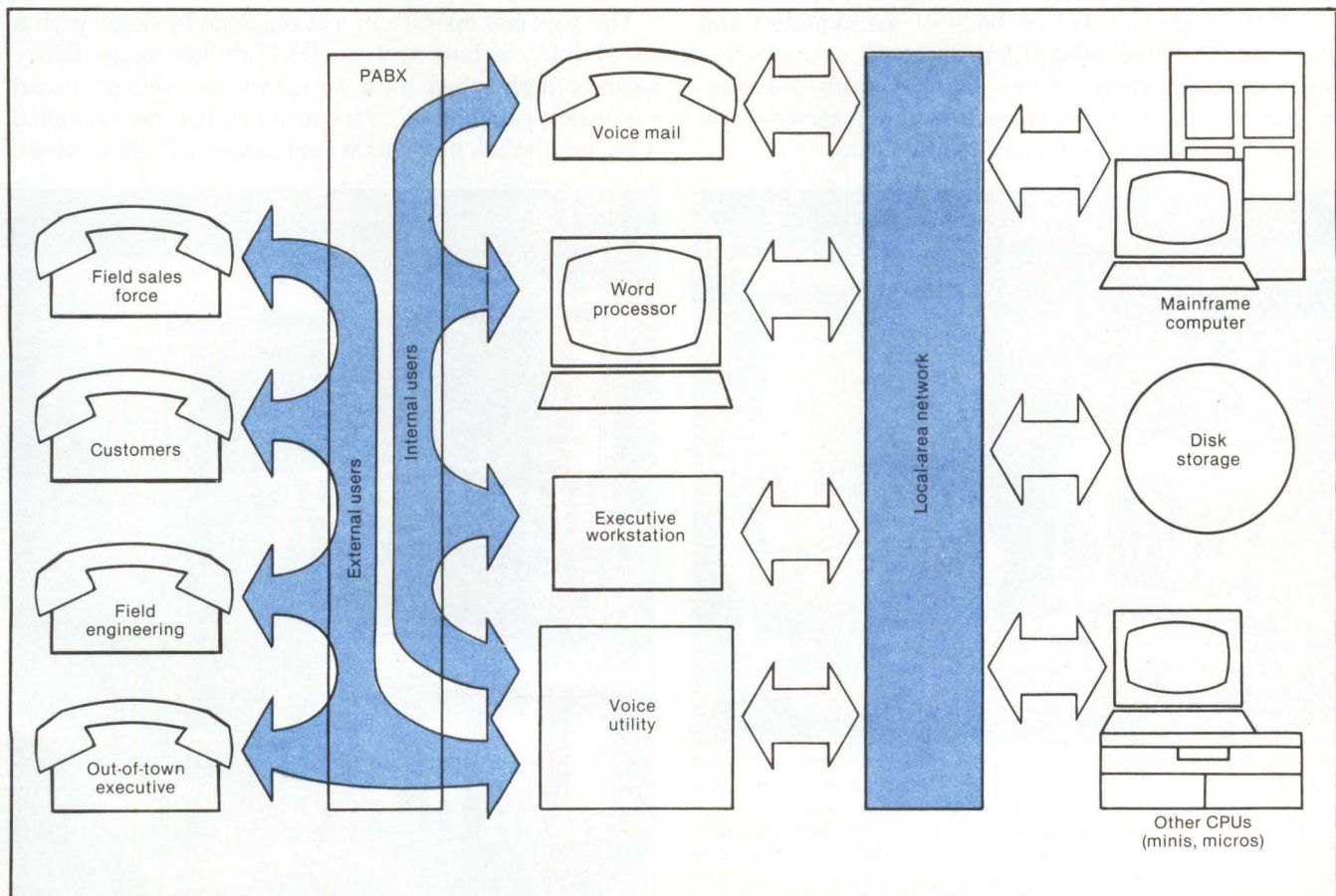

Fig. 3. The voice utility serves as the interface for a company's communications and electronic data-processing network. Both internal (local) and external (remote) users can access the voice utility via the PABX.

functions of the voice processor are transparent to the user.

VMS integrates multichannel configuration

Based on the voice-utility concept, Votan has developed a voice-management system (VMS) that provides the facilities for a complete shared-resource voice system. In multichannel configurations, Votan's VMS consists of a voice-control unit (VCU) and as many as four voice channels provided by VX series voice-processing and telephone-interface boards (Fig. 4).

The VCU serves as an intelligent controller in the multichannel system. The 8086-based VCU handles the real-time operation of VX series devices and telephone interfaces while communicating with a host processor through an LAN or a serial communications line. The VCU board is physically and electrically compatible with the industry-standard Multibus, and an RS232C line for monitoring or diagnostics is available to system developers. The 512K-byte system RAM is expandable to 1M byte.

Voice-processing capabilities are available on board-level VX series devices. This is the local processing ability of the voice utility containing Votan's proprietary technology, a complex body of mathematics and microcomputer technology that digitizes, extracts features and compresses voice data. Votan's software nucleus and hardware architecture integrates several voice technologies at low incremental cost.

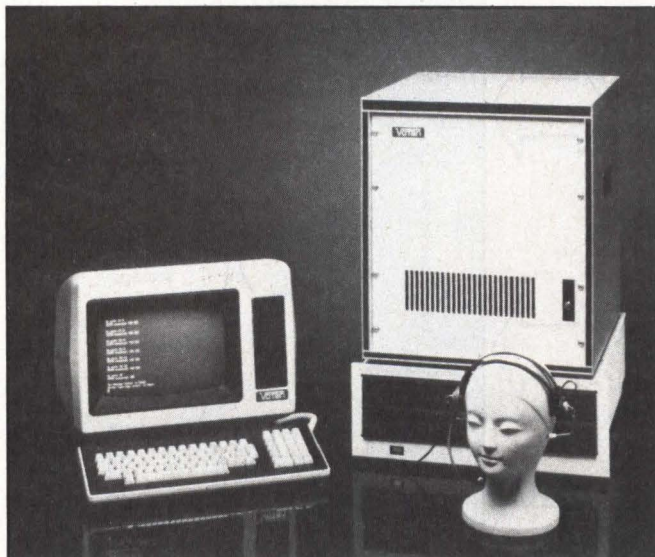

Votan's voice-management system (VMS) provides voice I/O support for various applications. The VMS includes as many as four voice channels, four telephone-interface boards, a voice-control unit (VCU) and a Multibus backplane. Price of VMS with speaker-dependent recognition (SDR), voice response (VR) and voice store and forward (VSF) is \$22,650. With speaker-independent-recognition (SIR) capabilities, the system sells for \$30,650. All models include a 16-slot card cage, the voice operating system (VOS) and 512K bytes of RAM.

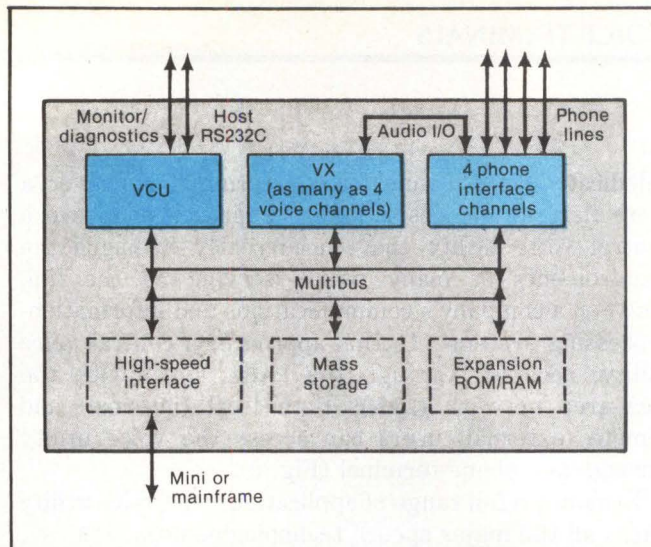
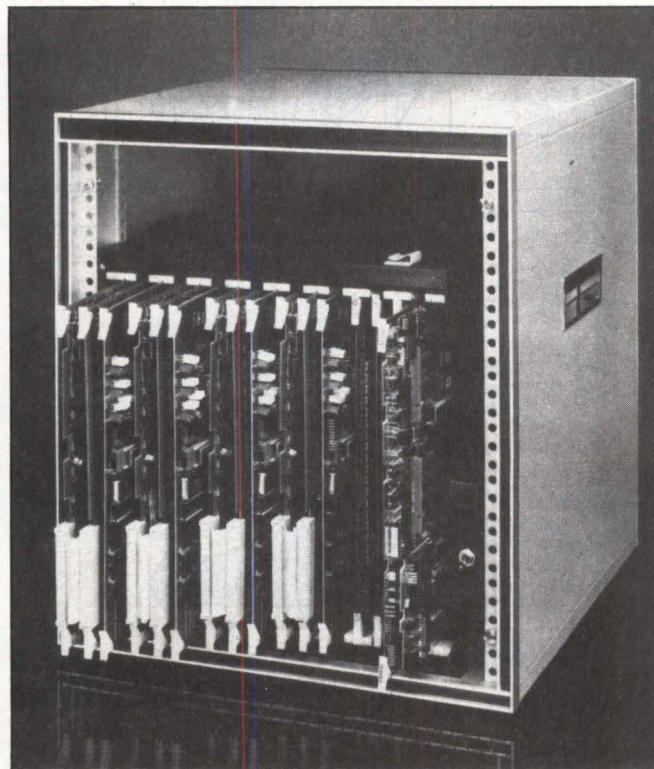
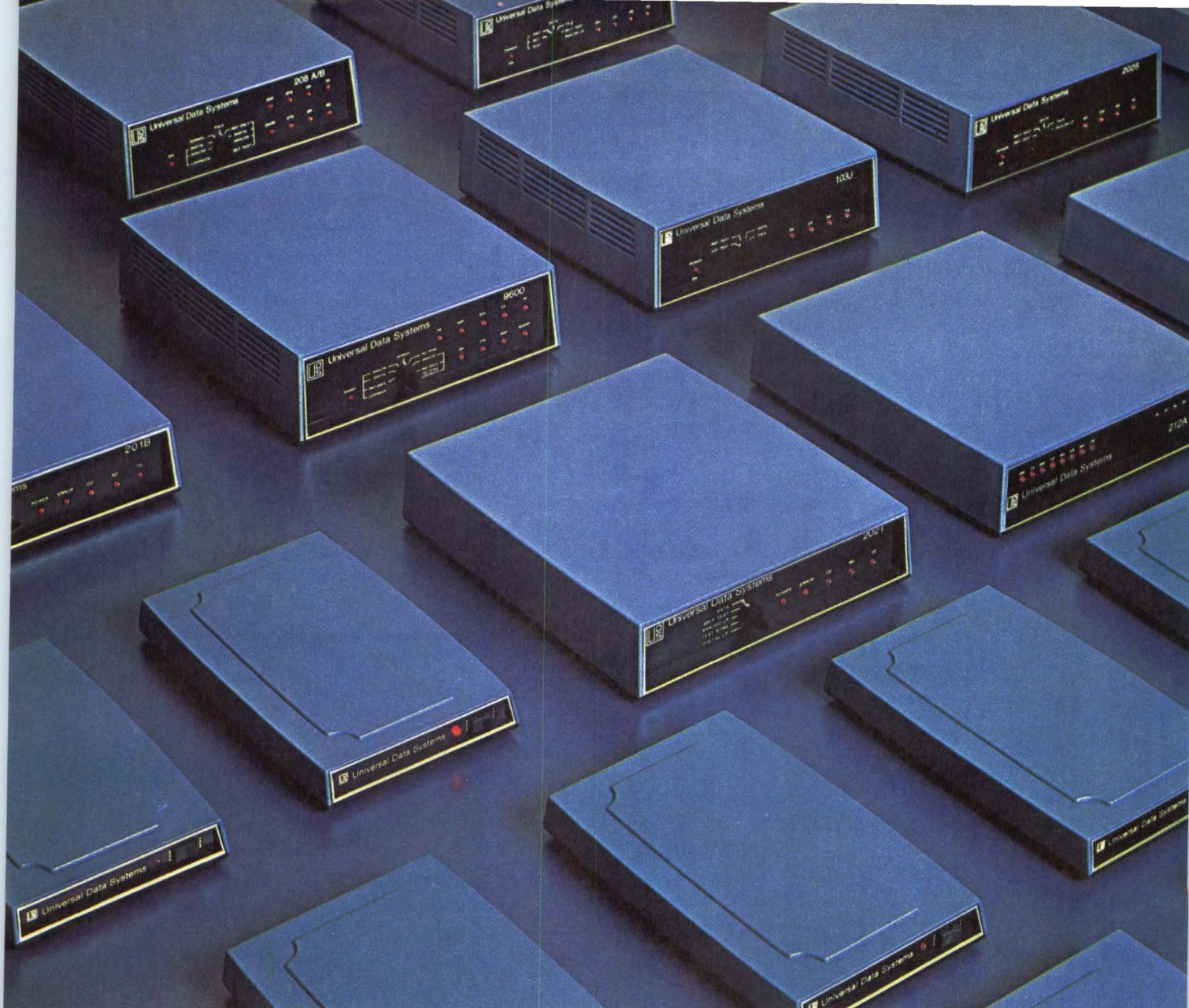

Fig. 4. Architecture of the voice-management system (VMS). An RS232C serial port connects the VMS to external intelligence if required by the application. VX series voice-processing devices contain A/D-D/A converter boards. The telephone-interface boards interface Votan speech-processing products to standard telephone lines.

A user can interface Votan's speech products to standard telephone lines via the telephone-interface board. Each microprocessor-controlled interface board can originate and answer calls through Federal Communications Commission-approved circuitry under VCU control.

The VMS can operate in a standalone mode or with a serial link to a host system. Its Multibus compatibility permits high-speed data transfers as well as broad expansion capabilities. VMS memory can be expanded with additional ROM, RAM and mass-storage devices.





MULTIPLE CHOICE: The UDS Modem Family

SPEED RANGE (bps)	DIAL-UP NETWORK		PRIVATE LINE		LINE POWERED	
	MODEL	PRICE	MODEL	PRICE	MODEL	PRICE
0-300	103J*	\$425			103 LP O/A	\$145
					103J LP*	\$195
0-1200	202S*	\$475			202 LP	\$195
					202S LP*	\$245
0-1800			202T	\$425		
1200/300	212A*	\$595			212 LP**	\$445
	212A/D	\$645				
2400	201C*	\$775	201B	\$695		
4800	208A/B*	\$1750	208A/B	\$1750		
9600	9600A/B*	\$2650	9600	\$2650		
			9600A/B	\$2650		

At speeds through 4800 bps, UDS modems are Bell-compatible and FCC certified for direct connection to the PSTN. The Model 9600 conforms to CCITT V.29 standards. All models are available as OEM boards and in multi-channel packages for central site applications.

For details and quantity quotation, contact Universal Data Systems, 5000 Bradford Drive, Huntsville, Alabama 35805-1953. Telephone 205/837-8100; TWX 810-726-2100.

 Universal Data Systems

 **MOTOROLA INC.**
Information Systems Group

DISTRICT OFFICES: *Auto-answer **1200 bps only Single unit prices.
Old Bridge, NJ, 201/251-9090 • Blue Bell, PA, 215/643-2336 • Atlanta, 404/998-2715 • Chicago, 312/441-7450 • Columbus, OH, 614/895-3025 • Boston, 617/875-8868
Richardson, TX, 214/680-0002 • Englewood, CO, 303/694-6043 • Houston, 713/988-5506 • Tustin, CA, 714/669-8001 • Mountain View, CA, 415/969-3323

COMDEX : Booth 2730

CIRCLE NO. 88 ON INQUIRY CARD

For applications requiring more than four voice channels, multiple VMS systems can be linked.

Developing and running the programs

A major consideration for users is the effort required for application-software development. Votan addresses this concern by offering a high-level software-development tool that simplifies and accelerates the development of I/O routines for voice applications. The voice operating system (VOS) consists of a computer, an interpreter and a dialog builder that run with the PC-DOS or RMX-86 operating system. In a run-time environment, VOS executes voice applications and interacts with the VMS.

VOS supports the voice applications development language (VADL), a high-level programming language that requires fewer commands than do general pro-

gramming languages. By isolating voice I/O functions from the application, VOS ensures high-level application integrity.

VOS programs are written in VADL, which is itself written in C. In a single-user system, VOS operates under PC-DOS on the IBM Personal Computer. In multiuser systems, VOS uses the Intel 8086 processor under the RMX-86 operating system. Because VOS produces an intermediate code that is executed by an interpreter in the run-time environment, the same VOS code can run without modification when transferred from the PC to the VMS environment. In concept, this is the same as P-code in Pascal systems. This allows the PC to be used as an inexpensive development environment with little additional effort to install the finished application in a VMS.

Four component programs provided with VOS to support VADL include a vocabulary-building utility, the VADL compiler, the executive and an interactive development aid for experimentation and immediate feedback when developing VADL code.

The VADL dialog source file (DSF) containing struc-

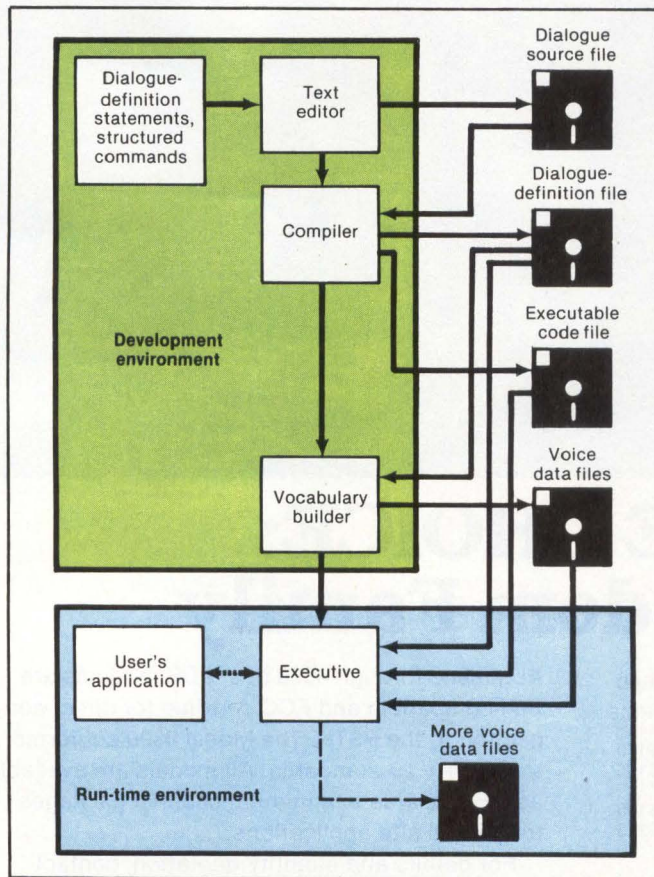

Fig. 5. The voice operating system (VOS) is comprised of component programs that support the voice application development language (VADL). Dialog-definition statements and VADL commands are entered via a text editor creating a source file. The compiler creates a dialog-definition file (DDF) and an executable code file (ECF) from the source file. Using the vocabulary builder, the DDF is accessed and actual voice data are entered, creating voice-data files (VDFs). In the run-time environment, the DDF, ECF and VDFs feed into the executive. More VDFs can be created according to the user's application.

The voice-management system provides a shared-resource voice system for virtually any voice application.

tured commands and definition statements is created using a text editor. This file is run through the compiler to produce a dialog-definition file (DDF), which specifies the voice elements of a dialog, and an executable-code file (ECF). The vocabulary builder is then used to enter voice data for each element specified by the DDF. The vocabulary builder is a menu-oriented, fill-in-the-blanks routine that allows the user to develop recognition templates, record messages and declare sets. Once defined, this information is stored in voice-data files (VDFs). In the run-time environment, the executive interprets the executable code and references the DDFs and VDFs to run the prescribed dialog while periodically exchanging information with a host system (Fig. 5). The "host" can be an operator's terminal, a remote computer connected to a VX series device or a coresident application program in a single-user or multitasking configuration.

Implementing voice-based systems

Building on the flexibility of the VMS and VOS, a system integrator can address the implementation of voice technology for the end-user environment in a planned, three-phase approach. As a prerequisite, the system designer must first select the most salable application as a starting point (such as factory floor data collection) and then select equipment that provides low

Draw Your Own Conclusions.

**With The Netway Communications Processor,
The Lines Of Communication Go Anywhere You Want.**

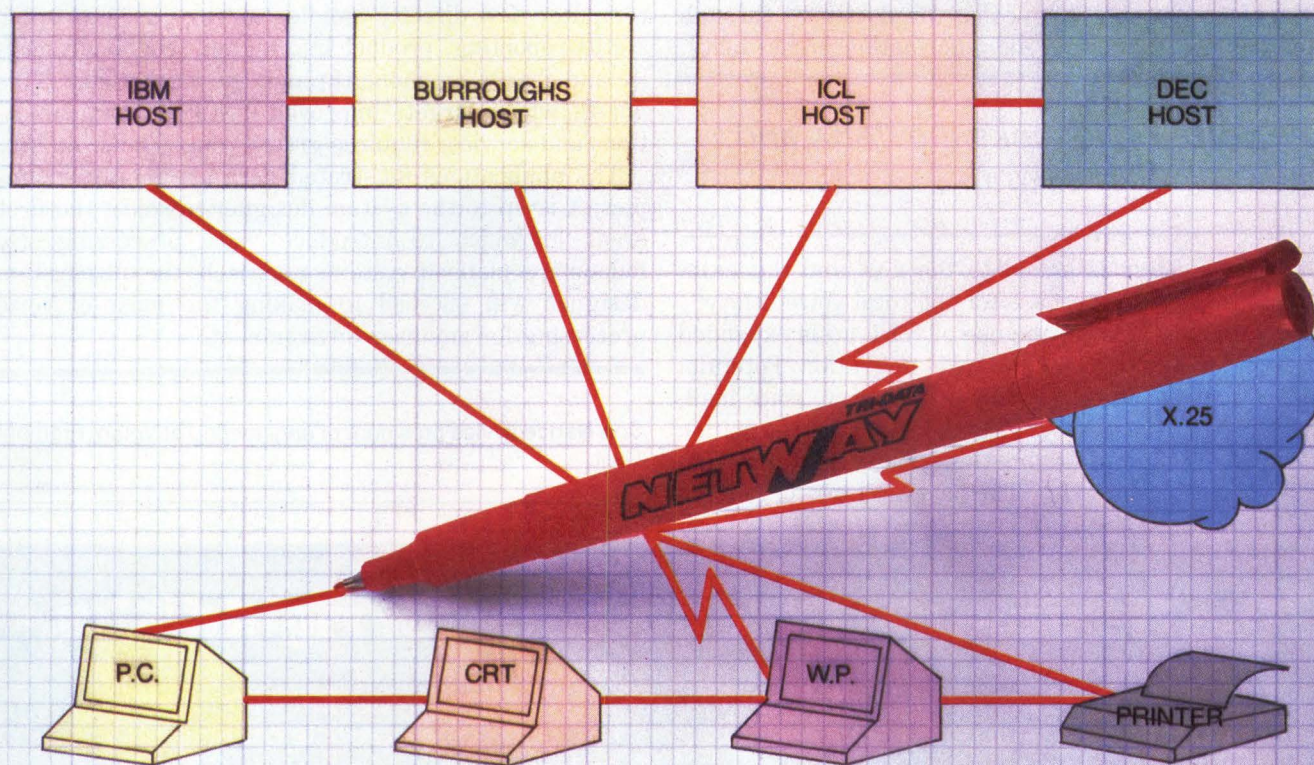

Let us introduce the next generation of communications processing. It's a product so versatile that it can support multiple and dissimilar protocols at the same time—IBM 3270 BSC, SNA, Burroughs, ASCII Start/Stop, ICL, and many others. A product so powerful that it can network together up to 8,120 workstations and hosts of various kinds. A product so affordable that you can start using it for as low as \$7920.

It's the Netway™ Communications Processor from Tri-Data. The first product that makes it both practical and economical to build networks out of dissimilar hosts and workstations.

With it, you can draw your own conclusions. Because the Netway Communications Processor is a **single solution** you can use in a number of ways, **right now**—as a gateway, a cluster controller, an X.25 PAD, even as a nodal pro-

cessor where its cost can be a fraction of the competition's. It's a high throughput solution, and one that can be easily customized or upgraded in the field.

As an OEM or systems integrator, you can use the Netway Communications Processor to enter new markets, quickly and profitably. Or to secure a more competitive position in an existing market. As an end user, you can use it to increase utilization of installed equipment and achieve significant savings from equipment purchases and line costs.

The Netway Communications Processor. Call or write today for more information. The conclusions you draw will be money in the bank.



Tri-Data 505 East Middlefield Road
Mountain View, CA 94043
(415) 969-3700
TELEX: 172282 TWX: 910 379 6978

TRI-DATA
NETWAY

*Netway is a trademark of Tri-Data Corporation.

CIRCLE NO. 89 ON INQUIRY CARD

VOICE TERMINALS

cost per user through shared resources and integrated voice technologies that can address the needs of multiple applications. The first phase in the three-phase approach establishes an initial architecture that provides for migration to other applications. A typical entry point is manufacturing, with voice data entry implemented on a production line, a stockroom, shipping/receiving or quality control. The target in this phase is improving blue-collar productivity through time savings, accuracy and information accessibility.

The voice utility links the PABX and the local-area network.

The voice system is linked to the LAN and the PABX system to provide the base for the total voice utility.

In the second phase, the use of voice I/O is expanded through a planned, company-wide migration. Potential applications include field sales-order entry, voice mail, dictation/word processing and management information retrieval. The target in this phase is improving white-collar productivity. The basic architecture estab-

lished in the first phase continues to serve all needs, with the addition of voice channels as the user base expands. Multichannel systems allow low incremental cost per user for the additional applications. The number of channels required generally does not increase proportionately as the number of users increases because only a relatively small number of users typically use the system simultaneously. For instance, an eightfold increase in the number of channels could service a 50-fold increase in the user base.

The third phase expands the internal base to include external communications, making automatic phone inquiry/response available to the customer base. The computer now directly handles services such as order status reporting, product information, customer service and charge by phone through the voice utility. This phase, which targets improved customer communications and service, requires greater dependence on SIR.

The applications illustrated here are merely examples; it is up to the system designer to select the first areas in which to introduce voice processing. By following a planned systems approach, the OEM/system designer will succeed in making the most of voice processing for any user environment. □

Joe Nance is vice president of engineering at Votan, Fremont, Calif.

The flexible particle counter for rigid disks.

Designed specifically to measure particle contamination in computer disk drives, this new counter, with its sample flow rate adjustable from 0.3 to 1.4 LPM, can qualify 5¼, 8 and 14-inch drives with a 0.3 µm sensitivity.

The all new Model 5000 features an RS-232-C computer interface for automation, six channels of particle size information, and a closed-loop air system with filtered air return line.

Call or write for more information on this exciting new particle counter. 141 Jefferson Drive, Menlo Park, CA 94025. (415) 325-7811.

 **PACIFIC
SCIENTIFIC**

HIC/ROYCO
INSTRUMENTS DIVISION

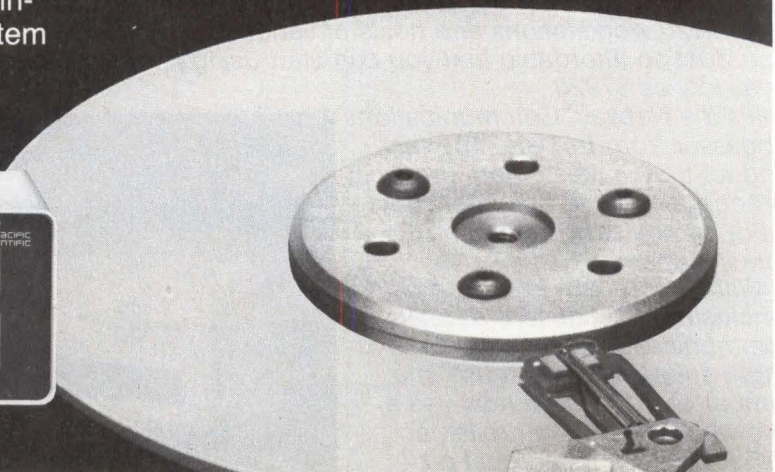
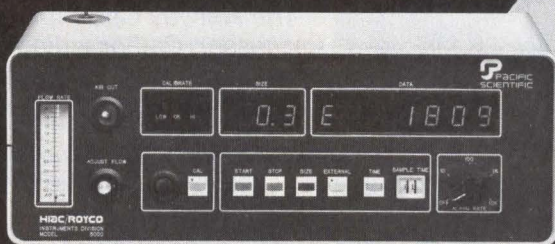

Drowning in a sea of solutions?

Help's within reach...

Applications backlog. Technology blur. Mounting user pressures. Staying abreast of changing prices. A tidal wave of problems!

Even if some answers are available, you have to go to too many sources and sift through so much information, there's not enough time to locate the solutions to your immediate and most important problems.

Well, help IS within easy reach—in the form of an information system that displays all your current software, hardware and communications options for instant reference.

That system is DATA SOURCES, and you're invited to make it work for you. Simply fill in the coupon and we'll send you DATA SOURCES' 4 quarterly editions at 50% off their regular cover price.

What DATA SOURCES does is organize your options. It guarantees that you've considered all relevant products by guiding you to those with the best possibility of success.

DATA SOURCES is a conveniently sized, extremely well-organized and skillfully indexed 2-volume reference...maintained on a data-base, constantly updated and published quarterly.

YOU GET...

HARDWARE—Over 16,000 products from Micros to Mainframes including peripherals—terminals, printers, memory devices, etc. ...organized by systems compatibility.

SOFTWARE—The largest available inventory of 17,000 business packages for micros, minis, and mainframes including operating systems, utilities, and application packages.



COMMUNICATIONS EQUIPMENT—From modems and multiplexors to local networks, carriers and services, plus all diagnostic and test equipment.

SERVICES, SUPPLIER, SUPPORT—Most complete organized listing of suppliers from installation design to maintenance and data center operations.

NEW FEATURES...

- ✓ Quick-reference product comparison charts.
- ✓ Market-tracking trends of new DP products.
- ✓ Before-you-buy selection criteria and checklist.
- ✓ Product Hotline—the very latest information on products announced between issues of Data Sources.

CIRCLE NO. 91 ON INQUIRY CARD

ORDER NOW AND SAVE 50%

Yes! Rush me the latest two-volume edition of DATA SOURCES and enter my subscription at \$60.00 for 4 quarterly editions. I save a full 50% off the regular cover price.

Name _____

Title _____

Company _____

Address _____

City _____ State _____ Zip _____

Telephone _____

Nature of Company's Business _____

Please check appropriate box: END USER VAR/OEM

DISTRIBUTOR DP MFG OTHER _____

An information product of Ziff-Davis Publishing Company. Satisfaction guaranteed.

SAVE TIME...CALL DIRECT
1-800-227-1617 Ext. 251
(In Ca., 1-800-772-3545 Ext. 251)

Return coupon to:

DATA SOURCES

P.O. Box 5845, Cherry Hill, N.J. 08034.

Residents of Ca., Co., Ct., D.C., Fl., Il., Ma., Mi., Mo., N.J., N.Y., Vt., please add applicable state taxes

T150

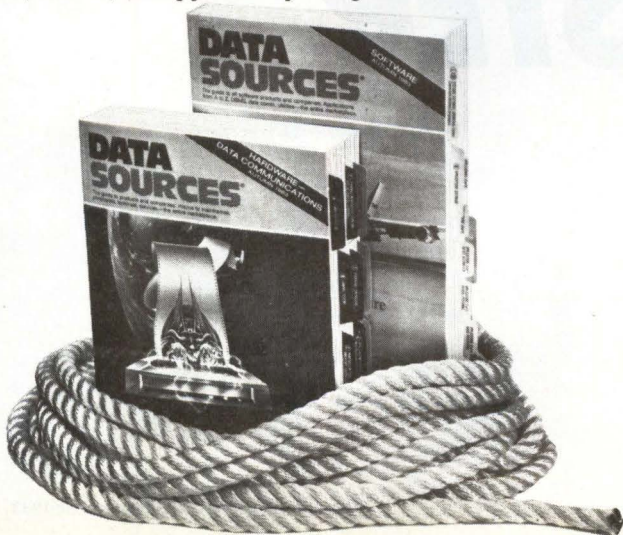



TANDBERG DATA TAKES THE NEXT STEP

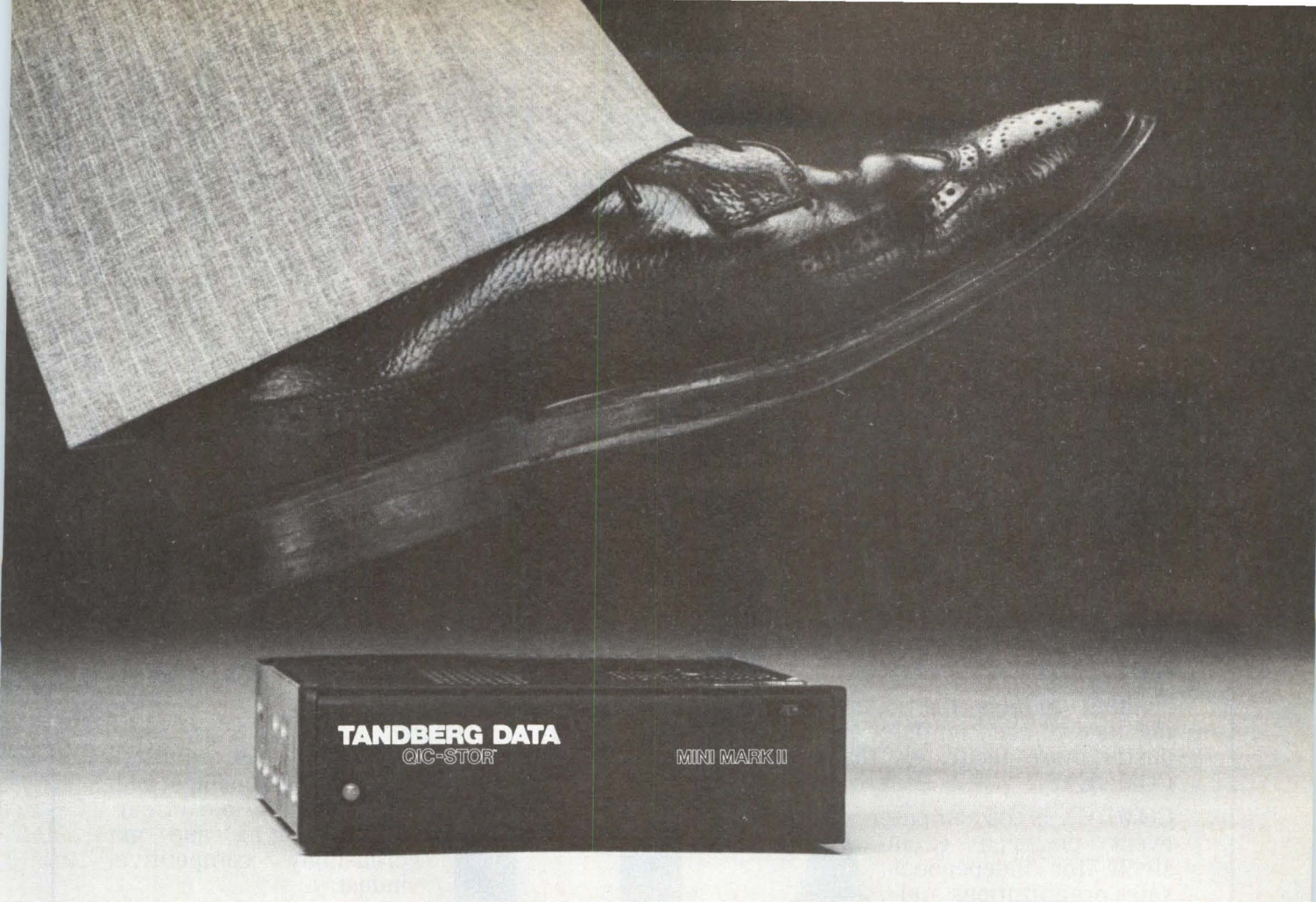

The first step, if you remember, was the introduction of our QIC-02 8" four- and nine-track tape drive. This 1/4" streamer set new standards for data integrity and accuracy. (You can actually stand on one.)

Our next step, the QIC-STOR™ Series, finally brings 100% QIC-compatibility to the 1/4" streamer market. And now with QIC-02 and QIC-24, our newly announced Mini-Mark II™ packs incredible performance and reliability

See us at COMDEX Booth #1676.

into a half-high 5 1/4" form factor. It has all the best features of our new 8" Mark II,™ including precise track locating and rugged cartridge locking/loading to totally eliminate the machine interchangeability problems that have plagued the industry. You get all this, plus capacities of up to 60 megabytes on a single 1/4" tape cartridge!

We've stepped up our facilities and capabilities too, just to keep up with demand. But that's another story. If you'd like the full story on our growing lineup of QIC-STOR streamers, you'll have to take the next step and contact Tandberg Data, Inc., DATA STORAGE DIVISION, 571 North Poplar, Suite H, Orange, CA 92668. (714) 978-6771.

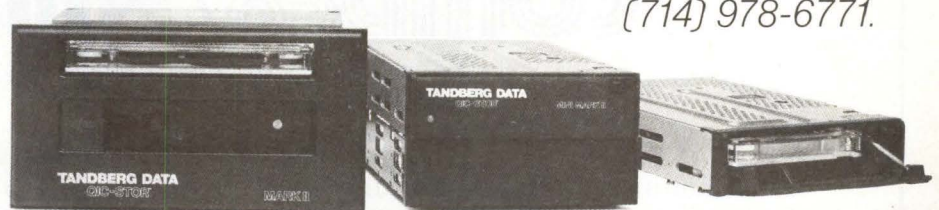

TANBERG DATA
QUALITY IN EVERY BIT.

CIRCLE NO. 92 ON INQUIRY CARD

SEE IT ALL.

HARDWARE, SOFTWARE...

Nothing reflects the changing face of the computer industry more accurately than COMDEX.

COMDEX is the computer event designed exclusively for independent sales organizations and your manufacturers and suppliers.

1400 EXHIBITORS...

This year over 1400 exhibitors will showcase the full range of computers, software and related products and services. In the area of software alone, nearly 300 companies will be represented.

55 CONFERENCE SESSIONS...

It's the only event with a rich tradition for providing a comprehensive Conference that is totally focused on ISO problems, productivity and profitability. At COMDEX/Fall '83,

150 experts will present 55 informative seminars.

COMDEX knows ISOs are business people anxious to establish new relationships and solidify the old in our fast changing and increasingly competitive industry.

Because in the computer industry, staying on the forefront is important.

What's new today may be outdated tomorrow. And COMDEX is

the one show that allows you to build, expand and strengthen your entire product line.

PRE-REGISTER TODAY...

This year's show has been expanded to five full days to enable you to see it all. Pre-register for COMDEX/Fall '83 today and take part in the world's foremost computer event. Call our Registration Department at (617) 449-6600.

COMDEX™/Fall '83

November 28 to December 2, 1983
Las Vegas, Nevada

For more information, call or write: COMDEX/Fall '83, ISO Registration,
300 First Avenue, Needham, MA 02194 • (617) 449-6600

Presented by THE INTERFACE GROUP, Inc., world's leading producer of computer conferences and expositions including COMDEX/Fall, COMDEX/Europe, COMDEX/Spring, INTERFACE, FEDERAL DP EXPO and the nationwide COMPUTER SHOWCASE EXPOS.



© Stewart Daniels 1983

UNIFY[®], The Number One UNIX DBMS, Brings All The Pieces Together.

Finally, a relational data base management system that unites all the best in state of the art technology. UNIFY provides more power, more performance, more flexibility, and more user friendly features than any other microcomputer DBMS on the market. No wonder UNIFY is the number one selling UNIX DBMS. Consider:

It's the most powerful. UNIFY is the most powerful relational DBMS available on a microcomputer today. That's because it features the only multiuser microcomputer implementation of the industry standard IBM SQL relational query language.

It's the fastest. Independent benchmarks have ranked UNIFY number one in performance time and time again.

It's the easiest to use. UNIFY's fully menu driven design makes it easy for anyone to develop data base applications.

UNIFY is currently available on microcomputers from DEC, Altos, NCR, Pixel, Onyx, Forward Technology, Fortune, Cosmos, Codata, Masscomp, Metheus, Momentum, Plexus, Perkin-Elmer, SGS, and Zilog — with more to come.

If you'd like more information about the number one UNIX DBMS, please call or write:

UNIFY
CORPORATION

9570 S.W. Barbur Blvd.
Portland, OR 97219

(503) 245-6585

UNIFY is a registered trademark of UNIFY Corporation.
UNIX is a trademark of Bell Laboratories.

CIRCLE NO. 94 ON INQUIRY CARD

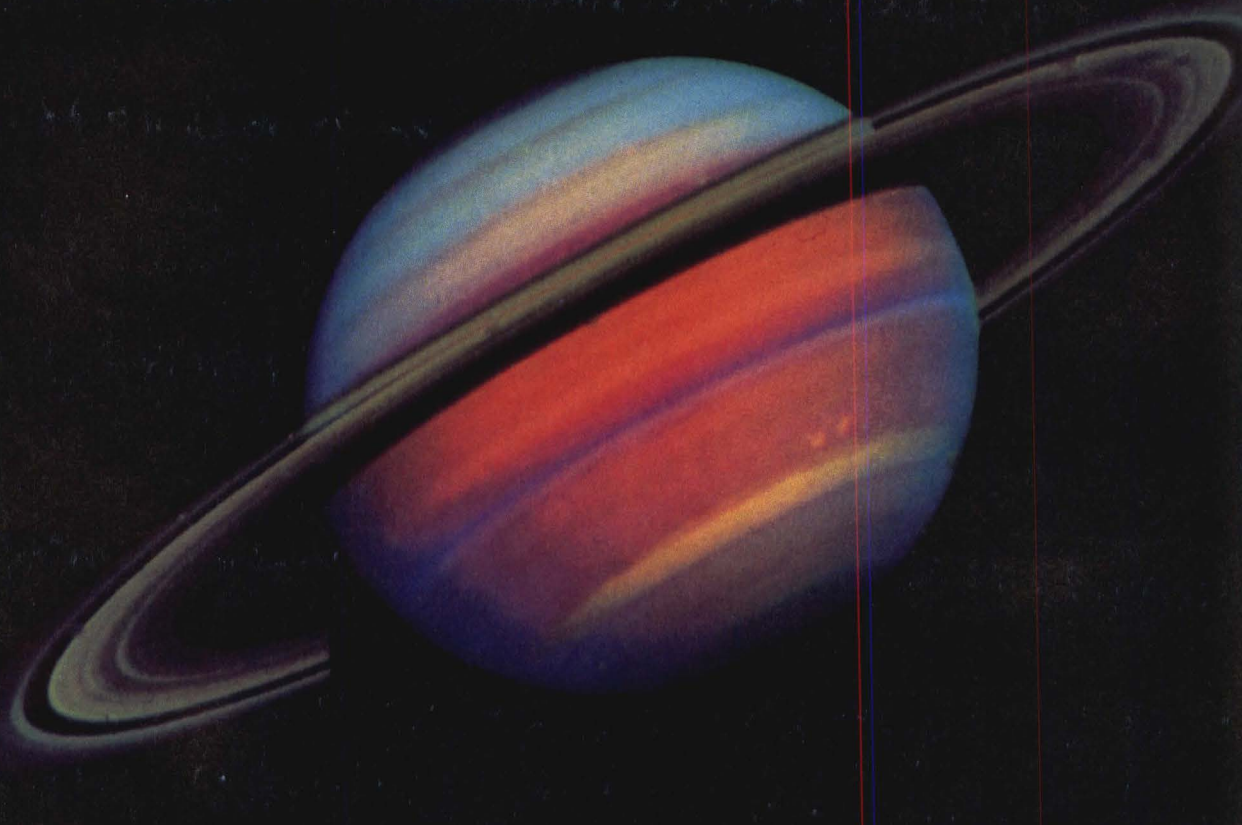

Only your imagination can limit the application of Comtal's new Vision Ten/24 Image Processing System.

Whether you're exploring the outer regions of space or exploring for oil in some remote area of the world, Comtal's new Vision Ten/24 is the only digital image processing system that processes and displays 1024 x 1024 high resolution images with a clarity never experienced before in image processing. It's a powerful tool for interpreting and analyzing images for such diverse applications as LANDSAT, meteorology, seismology, graphic arts, earth resource management, medical imagery, or something only you know about.

Four times the resolution at 30% lower cost.

The Vision Ten/24 is the only image processing system capable of processing and displaying images at a 1024 x 1024 resolution in real time (1/30 second) with a 40 MHz video output rate. That's four times the resolution of the industry-standard 512 x 512 systems. With it, whole new worlds open up. Inter-

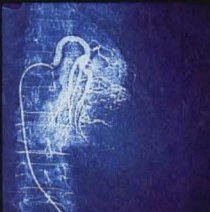

pretation and analysis become more precise. Best of all, the basic Vision Ten/24 system price is 30 percent less than our previous 1024 x 1024 system because of our design and manufacturing refinements. Giving you incomparable price/performance.

Building block flexibility.

Our modular design approach with the architecture of the Vision Ten/24 gives you flexibility along with easier system upgrades. You can increase video paths, memory size or processing power by simply adding modules. Making the Vision Ten/24 able to keep pace with your image processing requirements. In addition, the system can operate as a standalone image processor or can be interfaced to a variety of host computers.



Comtal—a generation ahead in image processing.

Our new Vision Ten/24 is a generation ahead of any other digital image processing system. It's not surprising since our systems have consistently been the state-of-the-art in image processing. For example, our 512 x 512 systems offer more exclusive features and options, and give you more standard models to choose from, than anyone else. With a decade of experience in image processing and more than 600 systems installed worldwide, only Comtal gives you the leading edge of image processing technology.

Put your imagination to work and give Comtal a call today for a firsthand look at our new Vision Ten/24. Comtal, a subsidiary of 3M, 505 West Woodbury Road, Altadena, California 91001, (213) 797-1175



COMTAL

CIRCLE NO. 95 ON INQUIRY CARD

GRAPHIC TERMINALS

The Whizzard 1650 combines color graphics and alphanumeric text. Base price of the keyboard and terminal is \$15,900. The graphics digitizer is priced at \$1400. A software interface for a Printacolor plotter is available for \$1200.



Design trade-offs in a multifunction graphics terminal

GARY I. WASHAM, Megatek Corp.

Engineering terminal combines text and color graphics

The Whizzard 1650 color graphics engineering terminal from Megatek Corp. is a low cost, versatile workstation with alphanumeric capabilities and a built-in line analyzer. Design trade-offs have resulted in a raster-scan terminal with an 8086 graphics processor, a hardware vector generator, a single-set raster plane buffer, a built-in VT100-emulating terminal for communications and text editing and a resident line analyzer for software debugging.

Resolution, refresh rates and flicker

Raster-scan resolution is a function of the number of individual pixels in the display field: the more pixels, the greater the resolution. However, as the number of pixels increases, so does the amount of processing time required to scan a line across the CRT screen, which decreases the number of frames that can be displayed each second. In addition, there is a minimum frame (refresh) rate below which some colors will appear to flicker more than others.

The goal is a display that provides an acceptable

resolution with a frame rate that is high enough to ensure that all possible color combinations will appear flicker-free. Although a vector stroke display would have provided a higher resolution, it would have placed the 1650 out of its low-end price range. To meet cost requirements, Megatek Corp. uses a raster display with the best available resolution, which is user-selectable between 512×512 and 640×480 pixels. The display operates at 47 Hz, which Megatek found was the minimum frame rate ensuring flicker-free viewing of all possible colors.

Vector-to-raster conversion

In a display-list system like the 1650, information is entered as vector data that indicates the end points of lines. To be displayed on a raster terminal, it must be converted to pixel data. The first step is to convert data received from the host computer into an internal display list format. In the Whizzard 1650, data received from the host is loaded under the control of memory management resident in the firmware into a local

256K-byte display-list memory. Because the display-list memory is in the terminal, the host supplies the data required for a specific display only once, freeing it for other tasks while the display data is being processed locally.

Display-list data is in 32-bit words, the first four bits forming 16 instruction lookup codes. The first 14 of these lookup codes instruct the 8086 graphics processor to go to a list resident in the firmware containing the most commonly used graphics operating commands, such as "draw" or "move." When any of these 14 codes specifying vector location is used, the remaining 28 bits in the word contain two 12-bit fields representing the x and y coordinates, and a 4-bit field containing color information. When the instructions do not directly involve vector location, these 28 bits are used to provide other instructions, such as dynamic and static attributes, transformation and segmentation data and

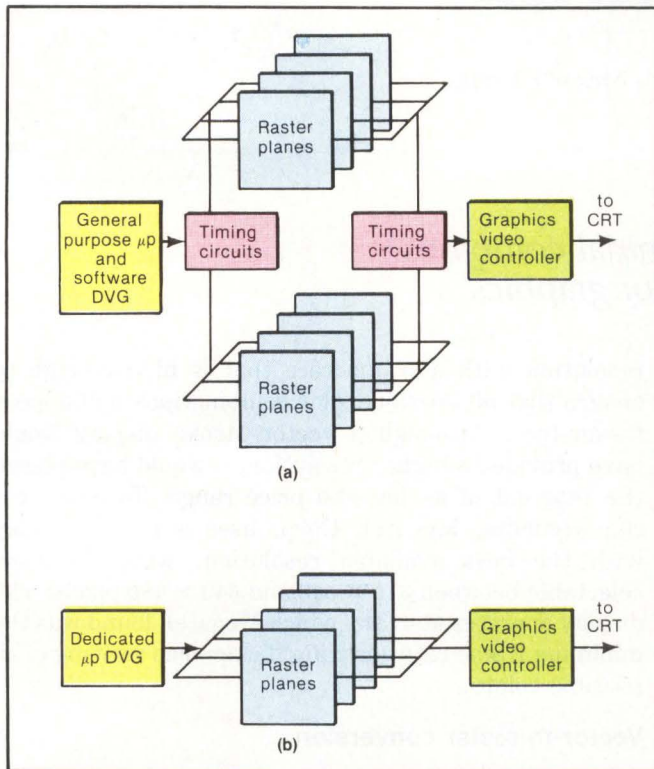

Fig. 1. A general-purpose microprocessor/software-based digital vector generator (DVG) requires two sets of raster planes and timing circuits for relaying information to the graphics video controller (a), due to the relatively slow processing power of the chip/software combination. The timing circuits direct the data into one set of raster planes while feeding the video controller from the other set of planes. This approach requires twice the memory of a single-set buffer system (b), as well as additional control circuits. The dedicated DVG is faster and requires only one set of raster planes.

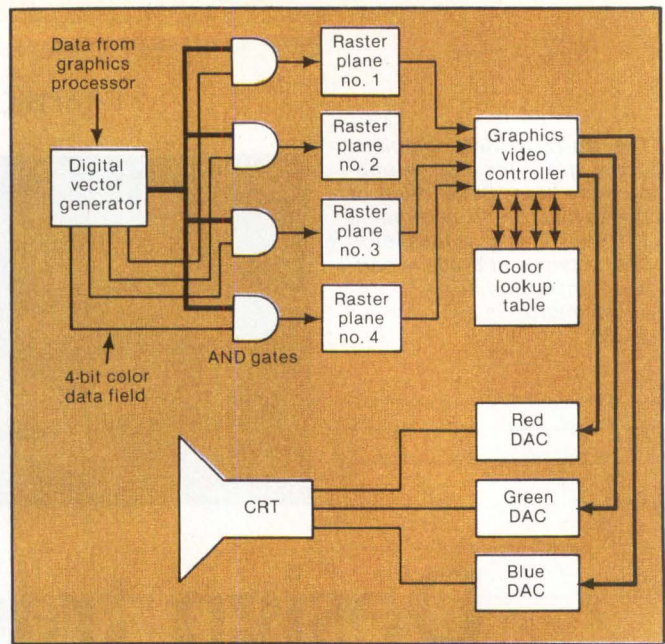

Fig. 2. Color generation in a graphics terminal requires the use of multiple raster planes. Each plane represents one bit of the color data field supplied by the host computer. In the Whizzard 1650, a screen-on set bit for a vector is loaded into the required pixel addresses through four AND gates, each controlled by one of the color data bits in the 4-bit color field. A graphics video controller scans the four raster planes and reconstitutes a 4-bit color word for each pixel address. This 4-bit word is applied to a color lookup table that provides the video controller with the correct percentages of red, green and blue required to produce the desired color. The video controller then generates three corresponding digital words that are applied to three digital-to-analog converters. The digital-to-analog converters produce the analog signals that control the CRT.

subroutines data. The graphics processor output consists of a stream of xy coordinate data and 4-bit color data fields, and is transmitted over an internal bus to the digital vector generator.

The DVG takes the xy coordinate data supplied by the 8086, calculates the length and direction of the vector and converts the vector to individual points to determine which pixels must be excited to produce a continuous line. The DVG uses Bresenham's algorithm to calculate the pixel data from the end points of the vectors (see "How Bresenham's algorithm draws lines quickly," p. 204).

One way to convert vector data to pixel data is to use a general-purpose microprocessor with instructions for Bresenham's algorithm in software. This approach minimizes hardware costs for the processor, although data conversion speed is relatively low.

Megatek chose an alternative for its 1600 Series terminals, designing a proprietary hardware DVG that executes Bresenham's algorithm in finite logic. Because the DVG processes the algorithm directly, without the intermediate interpretation of instructions required by a general-purpose chip and software, it can perform the required operations many times faster. The DVG in the 1650 can calculate raster data at the rate of 260 nsec. per pixel—approximately 10 times faster than most general-purpose microprocessors.

ESCAPE FROM THE REEL WORLD.

If you're faced with backing up today's high-capacity disks, you know the available alternatives haven't been too attractive.

Until MegaTape came along.

The inexpensive, book-sized MegaTape cartridge stores 330 megabytes in both streaming and start/stop modes. And unlike the 8 reels of conventional 9-track tape it replaces, it gives you 30-second average access to any file in the cartridge.

Best of all, the compact MegaTape drive costs under \$3,000 in OEM quantities, and uses standard controllers. And the design is so elegantly simple, reliability is outstanding. It's fast becoming the new industry standard for high-capacity backup.

So if you're looking for an escape from all the problems of the reel world, call MegaTape today.

We'll show you the easy way out.



**Call Gary Webb, Vice President,
Marketing at (213) 357-9921**

MegaTape Corporation, P.O. Box 317
1041 Hamilton Road, Duarte, CA 91010-0317

See our Demonstration at Comdex, Booth 251.

 **megaTape**

The great leap forward in backup.

CIRCLE NO. 96 ON INQUIRY CARD

The DVG generates data that specify the pixels that must be excited to paint a vector on the screen, and sends the data to an output buffer, or "raster plane." A raster plane is a large RAM buffer that is functionally a pixel map of the CRT screen; that is, there is a memory location in the plane for each pixel on the screen. The DVG's output is in the form of a memory address for a specific pixel and a bit that represents screen-on or screen-off. A video controller then reads out the contents of the plane and instructs the CRT beam to excite or to pass over the corresponding pixels on the screen (Fig. 1).

The number of discrete colors needed in a graphics terminal depends on the intended application. Imaging systems, for example, must produce many colors to represent a variety of shading and color gradations. However, the number of discrete colors that can be displayed simultaneously is a function of the number of raster planes in the output buffer. Increasing the number of planes to increase color capacity also increases the memory costs and the amount of space required. Since the 1650 is primarily a CAD terminal, only a few colors normally need to be displayed at any one time. Thus, four raster planes—able to produce 16 discrete colors simultaneously from a palette of 4096 hues—suffice, again minimizing space and memory requirements.

A video controller scans the address location in each of the four planes representing a specific pixel and reconstitutes the 4-bit color field. Each of the 16

HOW BRESENHAM'S ALGORITHM DRAWS LINES QUICKLY

To represent a line in a raster-display system, the system must employ an algorithm that determines which set of x and y coordinates for pixels most closely approximates the line. In complex displays, the algorithm can be invoked hundreds or even thousands of times each time an image is created or modified, so the algorithm must be extremely fast to be useful in an interactive environment. This precludes the use of slow operations such as multiplication (except integer multiplication by 2), division and all floating-point arithmetic. One obvious line-drawing algorithm—repeatedly incrementing the pixel x coordinate by one, incrementing the y coordinate by the slope of the line and rounding the y

coordinate to the nearest integer—is unacceptable because the slope and the rounding process involve floating-point arithmetic. Bresenham's algorithm uses only integer addition, subtraction and multiplication by 2—a special case of multiplication, fast because it can be implemented by a left-shift operation.

The inputs to Bresenham's algorithm are (x1,y1) and (x2,y2), the integer-valued line endpoints such that x1 < x2. The outputs from the algorithm are coordinates of the pixels that "fill in" the line. The version of Bresenham's algorithm shown, which applies to lines in which (x2-x1) ≥ (y2-y1) ≥ 0, increases the x coordinate of each successive fill-in pixel by one unit and increases the y

coordinate by either zero or one. Moving left to right from endpoint (x1,y1) to endpoint (x2,y2), each pixel is either one unit to the right of the previous pixel (a horizontal segment) or one unit to the right and above the previous pixel (a diagonal segment). The apparent slope of the line comes from the relative number of horizontal and diagonal segments: the greater the proportion of diagonal segments, the steeper the line appears.

—Roy R. Friedman

```
BEGIN /* Line endpoints are (x1,y1) and (x2,y2) */
testvar = 2*(y2 - y1) - (x2 - x1)
a = 2*(y2 - y1)
b = 2*(y2 - y1 - x2 + x1)
y = y1
FOR x = (x1 + 1) TO (x2 - 1)
  IF testvar < 0
    THEN testvar = testvar + a
    ELSE testvar = testvar + b
    y = y + 1
  WritePixel(x,y)
NEXT x
END
```

Initialization

Start of loop

Next pixel will be horizontal from previous pixel because y-coordinate is unchanged

Next pixel will be diagonal from previous pixel because y-coordinate is increased by one

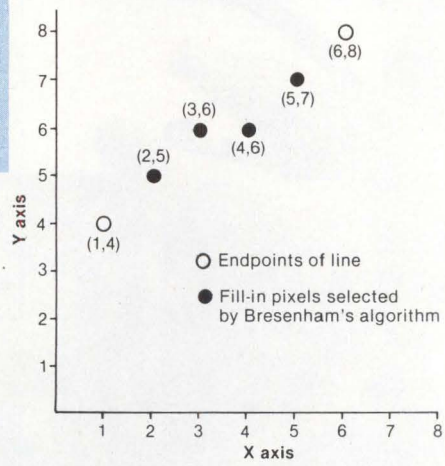

An example of the algorithm. To represent a line from endpoint (1,4) to endpoint (6,8), Bresenham's algorithm selects fill-in pixels at locations (2,5), (3,6), (4,6) and (5,7). The line is approximated by a diagonal segment from (1,4) to (3,6), a horizontal segment from (3,6) to (4,6) and a diagonal segment from (4,6) to (6,8). In an actual display, a line typically would be represented by many more than the six pixels used in the example.

Pseudocode for Bresenham's algorithm contains a loop that selects x and y coordinates for each "fill-in" pixel by increasing the x coordinate by one and increasing the y coordinate by either zero or one relative to the previous pixel. This algorithm is extremely fast because the code within the loop uses only integer addition and subtraction.

DELTA'S MAPPED OUT A WAY TO SOLVE 10,000 OF YOUR CARGO NEEDS.



**Delta Air Freight ships door-to-door between more than
90 cities covering 10,000 communities.**

See this Delta map? You can ship just about anything, big or small, between any Delta cities shown. That covers over 10,000 communities. You can ship door-to-door. Or airport-to-airport. Delta can frequently give your shipment same-day delivery.

Delta can ship anywhere in the U.S. or the world, via interline connections. In many instances, Delta Air Freight rates are lower than other freight services. And Delta will quote you special low rates tailor-made

for your shipments. Also ask about Delta Air Express—we guarantee to get your shipment on the flight specified. And Delta 3-D™ Air Freight—40% off regular freight rates on high density shipments.

For full details, call the Delta Marketing Office in the city nearest you. **DELTA**
The airline run by professionals.



DELTA AIR CARGO. READY ALL-AROUND.

INTRODUCING THE EASIEST WAY TO CALL UP YOUR SOFTWARE.

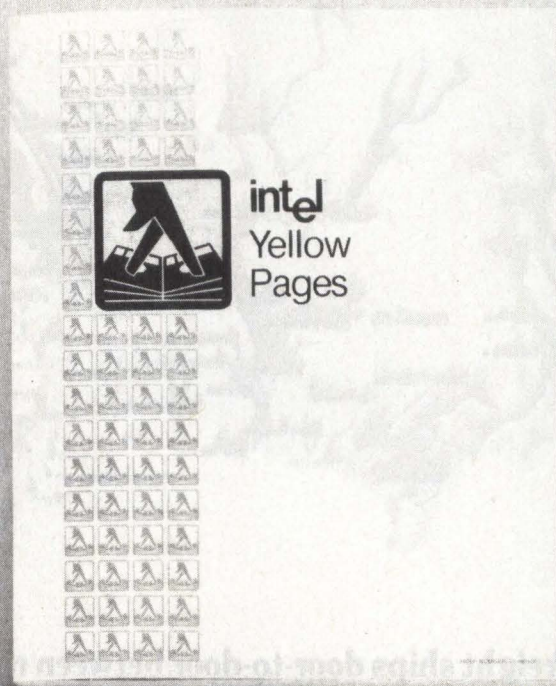

Introducing the Intel Yellow Pages. The first software directory of its kind. From the only company with enough software support to warrant it.

The Intel Yellow Pages lists 2,021 software products from independent vendors, consultants and ourselves. In both the U.S. and Europe.

There are 350 categories. Each category offering products completely compatible with Intel's entire iAPX 86 family. Including our new 80186 and 80286 microprocessors.

Our Yellow Pages is pure gold

when it comes to quickly finding the best applications software. Such as word processing, spreadsheets and project management. Even services like software development tools are covered for all of our 8 and 16-bit micros, boards or systems.

The book is priceless. It's free. Just send your name on company letterhead to: Intel, Lit. Dept. Z-15, 3065 Bowers Avenue, Santa Clara, CA 95051.

Then let your fingers do the programming.

intel delivers solutions

possible 4-bit combinations represents a specific color. The color lookup table determines the correct percentages of the three primary CRT colors (red, green and blue) required to produce the desired display color and produces three corresponding digital words that are sent to the D/A converters that drive the CRT. As the CRT beam scans along a horizontal line pixel by pixel, it is instructed to excite the red, green and blue phosphors of each pixel to the required intensity (Fig. 2).

A potential shortcoming of a system with just one set of raster planes is the inability to provide multicolor blinking. Normally, a second set of raster planes is required to provide an alternate-color blink. Megatek circumvented the need for a second set of planes by using four independent color lookup tables—the primary display table and three blinking tables—and a control system that sequentially scans them when blinking is enabled. Through program control, additional sets of 16 color values can be loaded into one, two or three auxiliary lookup tables. The display can provide 16 possible blink-rate patterns.

Communications and text editing

The user of a graphics terminal usually requires a separate alphanumeric terminal for communications with the host computer and for text editing. To

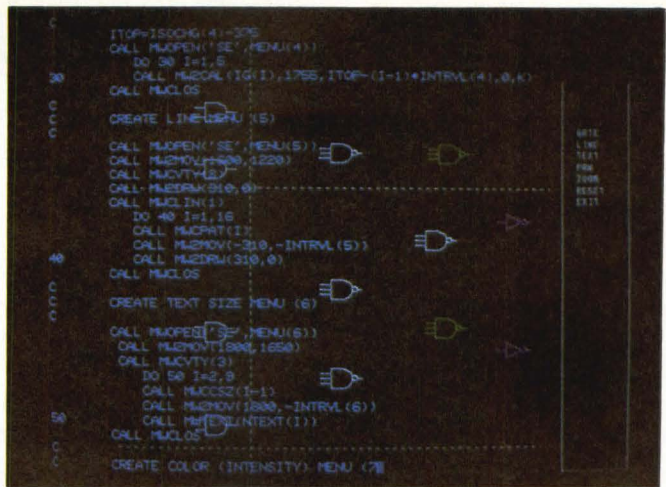

Fig. 4. The line analyzer generates an instruction-by-instruction program listing for all data flowing into or out of the terminal. To speed debugging, graphics instructions can be displayed step by step as the CRT is painted, so users can observe changes in the design as each instruction is executed.

overcome the need for an expensive peripheral, the 1650 is equipped in firmware with a virtual emulation of Digital Equipment Corp.'s VT100 terminal.

To add alphanumeric to a graphics terminal, a separate output buffer must be provided. But, since all the alphanumeric can be displayed in the same color, only a single raster plane is needed. The color of the alphanumeric displayed on the 1650 is user-selectable from a palette of eight pre-set hues.

The final step in adding alphanumeric is to combine the information contained in the alphanumeric and graphics sets of raster planes. While it wouldn't be difficult to add a video mixer, a problem remains: what happens if a vector and an alphanumeric character

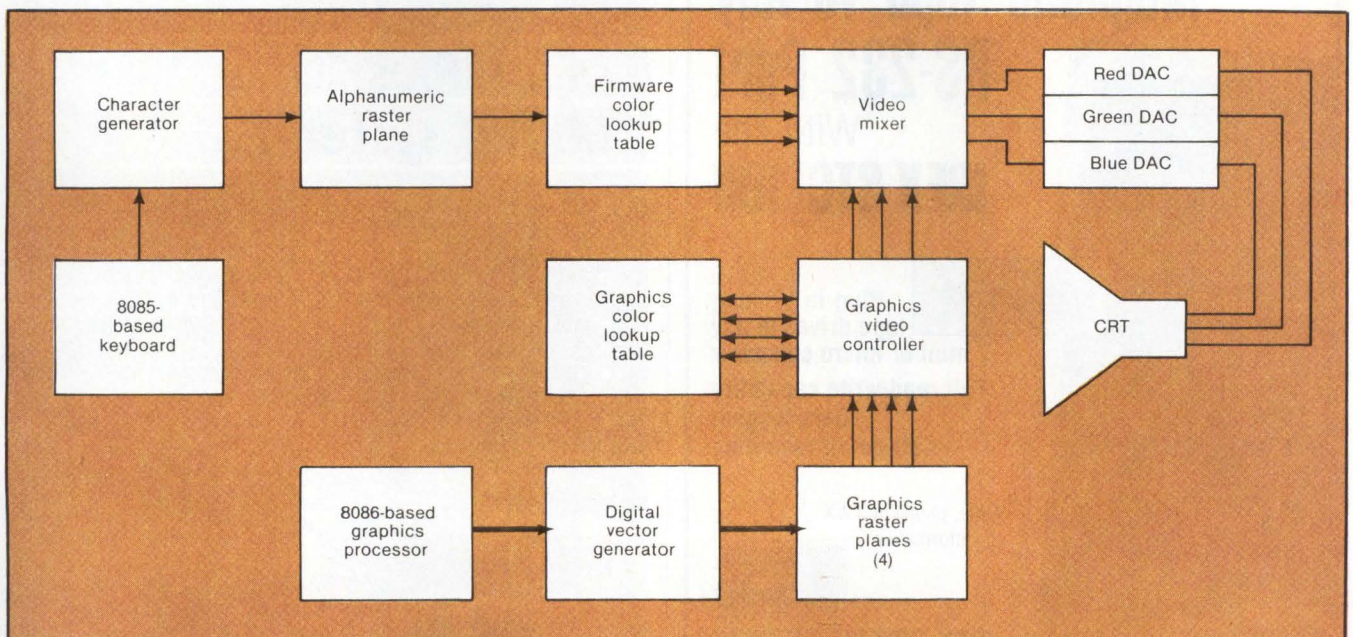

Fig. 3. Adding alphanumeric to a color graphics terminal requires the addition of a character generator, an independent raster plane and a color lookup table. Outputs from the alphanumeric and graphics lookup tables are applied to a video mixer that overlays the two displays on the CRT via the digital-to-analog converters. In the Whizzard 1650, the alphanumeric input has priority so that its assigned color will be displayed even if a graphics vector intersects the same pixel.

overlap in the display? When an overlap occurs in the Whizzard 1650, the pixels involved produce the color reserved for the alphanumeric. This is accomplished through the use of a controller that scans the alphanumeric raster plane and determines if the bit is set at a specific pixel address. If it is set, the alphanumeric color data for that address is applied to the video mixer, and the corresponding pixel is excited to produce the appropriate color. The color data contained in the graphics raster planes at that address are simply ignored. If the bit in the alphanumeric plane is not set, the controller scans the four graphics raster planes at that address and applies the resulting data to the video mixer (Fig. 3).

Software debugging

The Whizzard 1650 includes a firmware-resident line analyzer for software debugging. The analyzer, following instructions resident in the graphics processor firmware, generates an instruction-by-instruction program listing for all data flowing into or out of the

terminal. When invoked, the listing is displayed along the bottom of the screen and the nature (graphic or alphanumeric) and direction of data flow are identified by the type and placement of enclosing brackets.

The instruction display ordinarily scrolls rapidly, but it can be stopped at any point through keyboard control, then advanced one instruction at a time in a step mode. The display being painted on the CRT screen also appears at the stepped rate, so the user can observe the changes on the CRT screen as each new instruction is executed (Fig. 4).

A "byte-trapping" characteristic of the line analyzer permits a user to set an interrupt at a specific instruction in the program. When this is invoked, the display operates at its normal speed until the designated instruction in the program is reached, at which point the analyzer stops the program. The user can then instruct the analyzer through keyboard control to display a given number of program instructions preceding or following the breakpoint. Thus, the user doesn't have to go through the time-consuming process of examining the listing, instruction by instruction, to find the particular code that programs the step in which the bug may exist. □

Gary I. Washam participated in the development of Megatek's Whizzard 1650. He holds a B.S. in systems engineering from the U.S. Naval Academy and an M.S. in systems management from the University of Southern California.

**Add IBM Format-Compatible
Magnetic Tape To Any
RS-232 Port
With The
IBEX STC-100**



Plug-In 1/2" mag. tape drives to any mini or micro computer
Full read/write capability
Data logging
Call-detail recording

Write, phone or TWX for information



IBEX COMPUTER CORP.
20741 Marilla St.
Chatsworth, CA 91311
(213) 709-8100
TWX: 910-493-2071

Announcing new additions to our growing family of UniPlus+ UNIX™ 68000 systems...

<ul style="list-style-type: none"> ■ APPLE COMPUTERS ■ BLEASDALE COMPUTER SYSTEMS, LTD. ■ CALLAN DATA SYSTEMS ■ CODATA SYSTEMS, INC. ■ COLEX AMERICA, INC. ■ CORVUS SYSTEMS ■ COSMOS SYSTEMS, INC. ■ CYB SYSTEMS, INC. ■ DIGITAL COMPUTERS, LTD. ■ DUAL SYSTEMS CORPORATION ■ DY-4 SYSTEMS ■ HEURIKON CORPORATION 	<ul style="list-style-type: none"> ■ INTEGRATED SOLUTIONS ■ LEXIDATA CORPORATION ■ MEGADATA CORPORATION ■ MICROBAR SYSTEMS, INC. ■ ORCATECH, INC. ■ PACIFIC MICROCOMPUTERS, INC. ■ PERTEC COMPUTER CORPORATION ■ PIXEL, INC. ■ VICTORY COMPUTER SYSTEMS, INC. ■ WICAT SYSTEMS ■ XYVISION, INC. ■ ZEHINTEL
---	---

UniSoft SYSTEMS

2405 Fourth Street, Berkeley, CA 94710 • (415) 644-1230
TWX II 910 366-2145 • UUCP ucbox:unisoft:unisoft

*UNIX is a trademark of Bell Laboratories

How to teach your business procedures without all the fancy footwork.

If you're like most people who run offices, you've spent a lot of time developing procedures for routine office jobs.

But until now, teaching people to follow those routines meant constant explanations. And re-explanations. Especially for offices with high turn-over.

INTRODUCING STARBURST.®

A software system building tool that lets you create your own management system tailored to your own office routines. StarBurst integrates all MicroPro programs, as well as most other leading software programs.

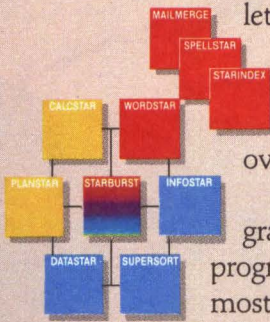

CUSTOM-DESIGNED EFFICIENCY.

With StarBurst, you can design your own custom menus that prompt even the most inexperienced staff member through an assigned task. Step by step. In your own words.

So anyone in your department can get to work immediately. And quickly. For instance with a single keystroke, data generated in InfoStar® can be incorporated into a letter written in WordStar®. All automatically.

Which means the people in your office save hours preparing reports, entering data or performing just about any other routine procedure.

StarBurst is also available in InfoStar+, the data base management system for non-programmers.

TAKING THE WORK OUT OF ORGANIZING YOUR OFFICE.

We've made system set-up easy too. Just put together a basic model, then change it easily using StarBurst's 24 menu-prompted action commands.

You can display customized help messages. Repeat sequences as often as necessary. Even set up systems that vary the sequence of what a user should do next.

And StarBurst assists you each step of the way with an onscreen tutorial and companion workbook.

So set an example in productivity for the entire office. Walk on over to your computer dealer, and ask about StarBurst. For the dealer nearest you, call (800) 443-0100 ext. 948.



MicroPro.

When you start with MicroPro, there's no stopping you.

For name of the dealer nearest you, phone (800) 443-0100 ext. 948. For more information write MicroPro, 33 San Pablo Avenue, San Rafael, CA 94903. (415) 499-1200.

CIRCLE NO. 100 ON INQUIRY CARD

Our UNIX Super UPI Cover



Microsystem Helps The World.

We're Dual Systems.

And our 83/20 16-bit super microsystem is a real success story for United Press International.

By appointing our 83/20 as the computer base to their Newspaper Computing System, the people at UPI now enjoy networking journalism on an even larger scale. They transmit stories. They transmit graphics. They transmit photos. And they do it instantly.

Because they know late-breaking news can't be late.

However, UPI isn't alone in its decision to use Dual Systems. On the contrary. Boeing, Sony, Ford, and General Electric are also some of the names you'll find on our blue-chip client roster.

Perhaps the reasons for such a stellar following are the 83/20's minicomputer capability and microcomputer price. And it's backed with a one-year warranty.

And that it's powered by the outstanding Motorola MC68000 which delivers approximately one million instructions per second running at 10MHz.

And that our 83/20 includes full UNIX* System III with Berkeley enhancements like C-shell and Visual Editor.

And that it provides Source Code Control and language options, including BASIC, COBOL, PASCAL, FORTRAN 77, and ASSEMBLER.

Then again, our 83/20's success may be due to the strict conformance of the IEEE696/S100 bus architecture.

Of course, some customers have told us they particularly like the 83/20 for its incredible application versatility. Like graphics. And automatic typesetting. And robotics. And digital plotters. In fact, name an application and the chances are very good you'll find our 83/20 can handle it.

Our track record is also rather impressive — we've been delivering 68000-based systems with full UNIX capability longer than anyone else — that adds up to a 68000, multi-user, UNIX-based super microsystem with proven reliability.

Whatever the reason for our 83/20's remarkable market acceptance, you'll like it because it does all of the above at a price you can easily live with: quantity ten at \$11,662 per system.

So, while it helps UPI, Sony, Ford and General Electric, the good news is that it can help you.

For further information, please write or telephone our Marketing Department at 415/549-3854.

We'll give you the complete scoop.

DUAL

Dual Systems Corporation
2530 San Pablo Avenue
Berkeley, CA 94702

*UNIX is a trademark of Bell Laboratories.



CIRCLE NO. 101 ON INQUIRY CARD

FORM FACTOR.

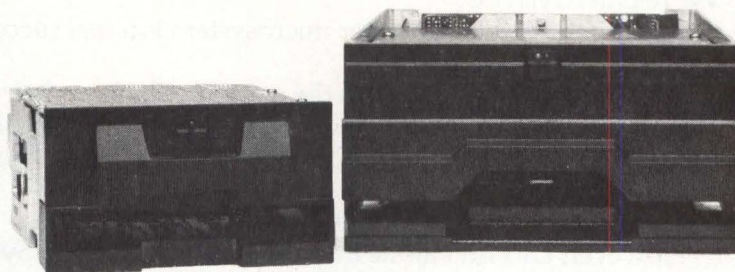

REFORM FACTOR.



In the data storage business, some things change faster than others. And some things change faster than they should. When it comes to capacity, performance, reliability, and cost efficiency, the rule is clear: "the faster the better." But when it comes to changing the physical dimensions of drives, "not so fast" makes better sense. After all, as an OEM, you're looking for as much system continuity as possible.

IOMEGA's Alpha 10 And Beta 5: True To Form—And Reform.

What IOMEGA's disk drives—the 10 Mbyte Alpha 10 and 5 Mbyte Beta 5—share in common with many others on the market is *form factor*. The Alpha 10 matches the dimensions of all standard 8-inch drives. And the Beta 5 does the same for standard 5¼'s.

What the Alpha 10 and Beta 5 *do not* share with anyone else is a new technology that allows us to offer *mass storage capacity on a flexible medium*, utilizing the popular cartridge format. We call it our *reform factor*. Because, with 10 and 5 Mbytes for starters, what we've done, quite literally, is re-form the previous notions about how much data could be put on a flexible disk.

More Than More Storage.

IOMEGA's design features—such as non-contact head-to-disk interface, high-linear bit densities, and enclosed servo control of the head positioning—result not only in *more* flexible disk capacity, but in *more* performance, reliability, versatility, and economy as well.

And it results in *more* ways to use that storage, too. IOMEGA's greater reliability makes the Alpha 10 and Beta 5 perfect for primary mass storage. And their flexible, low-cost cartridge design makes them natural for back-up and archival storage as well.

More capacity. More performance. More reliability. More versatility. More economy. *And no more waiting.* Because IOMEGA is delivering both the Alpha 10 and Beta 5 in OEM quantities *right now*.

Call today for *more* information.

See us at COMDEX Las Vegas
Convention Center Booth #4760

The IOMEGA logo consists of the word "IOMEGA" in a bold, blue, sans-serif font. The letter "O" is stylized with a white dot in the center, resembling an eye or a lens.

IOMEGA Corporation, 4646 South 1500 West
Ogden, Utah 84403 (801) 399-2171

Why it's worth every nickel.



If you laid every nickel this terminal cost end to end, it would lead to a real bargain.

Because if you're the kind of professional who buys an Ann Arbor terminal, you put the emphasis on what you get out of it. Not what it costs to get into it.

The best way to explain that is by telling you about one of our best-selling terminals: the Ann Arbor Ambassador™.

The Ambassador offers incredible value for the money.

Starting with a full 15-inch screen, portrait or landscape. A 60-line display with vertical zoom. (You won't find that anywhere else.) A hard-working keyboard with dozens of programmable keys.

Then there's the fully buffered peripheral port with separate, user-settable baud rate. ANSI-standard coding. Multiple page and window capability. Pause and Meta functions. Tilt-swivel or rack mounted frame. And dozens of other ergonomic features that have made the Ambassador a favorite among

value-minded professionals nationwide.

Now that you know all that, take another look at the nickels on this page and ask yourself this:

Is it really true that money can't buy happiness?

For more information about the Ambassador and our other fine terminals, write Ann Arbor Terminals, Inc. at 6175 Jackson Road, Ann Arbor, Michigan 48103. Or call us at 313/663-8000. You'll find it worthwhile.

ANN ARBOR

TERMINALS

Once you've worked with them, you won't work without them.

CIRCLE NO. 103 ON INQUIRY CARD

*Bit-mapping graphics board joins
16-bit CPU card to furnish
near-photo-quality resolution*



UNIX-based graphics system produces 1 million-pixel display

DENNIS DANIELS, Forward Technology Corp.

Supporting the refresh of a 1 million-pixel graphics display need not tie up the processing power of a 16-bit CPU. Graphics functions can instead be unloaded to a specialized graphics board with key raster-scan operations hard-wired into its graphics processor. By combining these raster operations with an on-board bit-mapped 1M-bit memory and a Multibus-compatible

16-bit processor, OEMs can implement a graphics system similar to Forward Technology Corp.'s FT-500 Gateway engineering workstation, which can update the frame of a near-photo-quality graphics display in only 64M sec. The FT-500 workstation is organized around an eight-slot Multibus card cage, holding the graphics board; a CPU board; plus optional Ethernet-, disk- and tape-controller boards.

Focusing on the graphics board

The heart of the graphics system is the FT-1024 graphics-controller board, containing the graphics processor, the bit-mapped 1M-bit memory, a 128K-byte

The graphics workstation's 1M-pixel display (above) highlights this configuration that includes a 20M-byte Winchester disk drive, a 20M-byte cartridge-tape drive, 256K bytes of RAM, a VT100-format detachable keyboard and a mouse for entry of graphics commands.

GRAPHIC WORKSTATION

RAM and a Multibus interface. The memory can store the contents of a complete graphics-display frame, with 1 bit of memory representing 1 pixel of the frame. This bit-mapped approach works in conjunction with the novel architecture of the graphics processor. It performs Boolean operations on the contents of three 16-bit operand registers—source, mask and destination—updating a 1-by-1- to 1-by-16-pixel segment of display data in the frame buffer (Fig. 1). The graphics processor also contains a function unit, controlling the display data sent to the frame buffer; a set of command registers for function, width, control and interrupt; and four sets of X and Y address registers.

The 8-bit function register holds the results of Boolean operations performed in the function unit on data in the source, mask and destination registers. These include logical OR, NOR, XOR, AND and NAND operations, which, including permutations, create 256 possible raster operations. The function unit feeds the 16-bit result of the Boolean operations into the frame buffer at locations specified by the CPU via the graphics board's address logic. The frame buffer, in turn, serializes the data for driving a 50-MHZ Ball HD series or Motorola M4408-type CRT.

A logical OR on the contents of the source and mask register is typical of the Boolean operations performed in the function unit. If the source register, for example, contains a right-slanting diagonal slash and the mask register contains a left-slanting diagonal slash, the

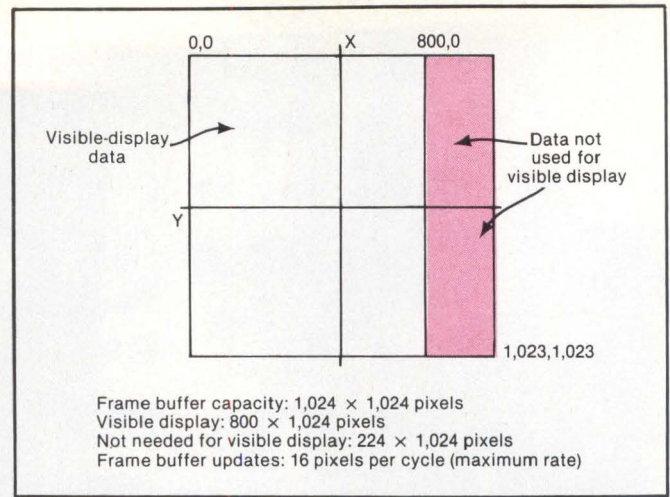

Fig. 2. Although the graphics board's frame buffer can store information for a 1,024-by-1,024-pixel display, only an 800-by-1,024-pixel portion of it is needed to update the graphics system's CRT screen. The remaining locations can store often-used graphics symbols and objects, which can be quickly moved into the CRT's visible display. Each frame-buffer location, designated by coordinates 0,0 to 1,023, 1,023, represents an individually addressable pixel on the CRT screen.

resulting X pattern feeds into the frame buffer. A logical AND operation would produce the dot in the center of the X.

Although the frame buffer can store information for a 1,024-by-1,024-pixel display, the graphics system's display area measures 800 by 1,024 pixels. The remaining portion of the frame buffer not needed for visible-display data can store often-used graphics characters and other symbols (Fig. 2) as a library of cells that can be rapidly moved or duplicated in the visible display. (Moving and duplicating the cells in this

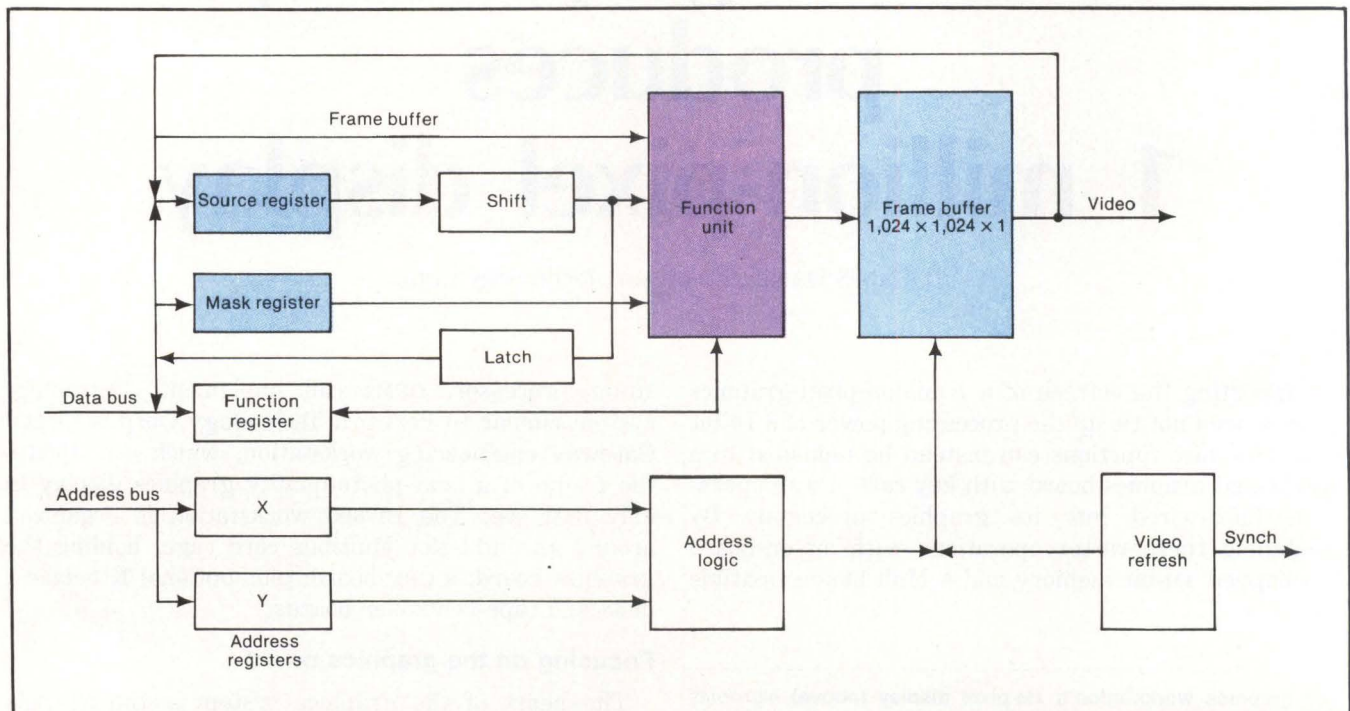

Fig. 1. The FT-1024's graphics processor uses its function unit to perform Boolean operations on data in the source, mask and destination registers. The 16-bit result is sent into the frame buffer at locations specified by the CPU via the graphics board's address logic.

**THE SMART CABLE™
MAKES VIRTUALLY ANY
RS-232 CONNECTION
AUTOMATICALLY
INSTANTLY.**

**NOW YOU CAN
INTEGRATE
CUSTOM SYSTEMS
WITHOUT
CUSTOM CABLES.**

The Smart Cable™ from IQ Technologies makes the right connection between computers and peripherals.

Unique on-board logic "looks" at the RS-232 interface on each end, then correctly interconnects the equipment. That's right—data lines, handshakes, everything.

**NOT A
BREAKOUT BOX.**

The Smart Cable is an instant custom cable. Priced competitively with conventional cables. Which makes it indispensable for systems installers, service technicians, computer retailers—anyone who sells or services computers.

**IT MAY SOUND
TOO GOOD
TO BE TRUE.**

So we'll prove it by offering you a sample Smart Cable (one per company, please) at a special price.

Our way of convincing you that the Smart Cable is the best tool for computer installation since aspirin.

Call us at 800-232-TECH (in Washington 206-451-0232, in Canada 800-663-9767), for the name of the distributor nearest you.

Sell the Smart Cable and you'll always have the right cable in stock. And you'll be making money while your competition is making cables.

SmartCable™

**INTRODUCING THE
INTELLIGENT
ALTERNATIVE TO
CUSTOM CABLES.**



IQ TECHNOLOGIES, INC.
11811 N. E. First Street
Bellevue, WA 98005
(206) 451-0232
TELEX 701 472 IQTECH UD

CIRCLE NO. 104 ON INQUIRY CARD

ROBOTIC DISK HANDLER

Looking to your future, Applied Data Communications proudly presents the **ROBOTIC DISK HANDLER** — the ultimate in automatic handling of floppy diskettes. This innovative system has the capacity to load and unload up to 100 floppy diskettes, unattended. Diskettes are handled in a very gentle manner as the system simulates the action of a human hand. It is a third generation modular design which enhances the state-of-the-art by effecting total reliability, not apparent in earlier designs. Enhance your company's future in the automated handling of floppy diskettes with a **ROBOTIC DISK HANDLER**. Realistically you will save time and money with this futuristic system, priced as low as \$7995.00. Inquire into the multitude of outstanding features that are incorporated in the **ROBOTIC DISK HANDLER**. Your future is here — now!

DALLAS, TX
(214) 352-4012

BOSTON, MA
(617) 273-4844

SANTA CLARA, CA
(408) 748-8686

TUSTIN, CA
(714) 731-9000

WASHINGTON, D.C. — (703) 356-7450

ALSO: TOKYO, FRANKFURT, PARIS, LONDON
STOCKHOLM, OSLO, MILANO, COPENHAGEN
SYDNEY, BOMBAY, TAIPEI

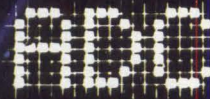

**APPLIED DATA
COMMUNICATIONS**

14272 CHAMBERS ROAD, TUSTIN, CALIFORNIA 92680

Ask about our new **HIGH SPEED IC-475 INITIALIZE/
COPY SYSTEM** — it's very fast and very reliable.

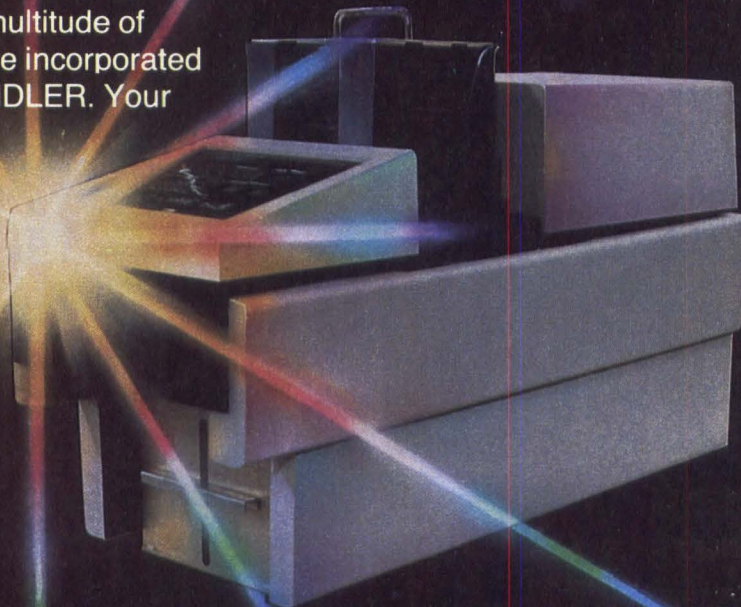

CIRCLE NO. 105 ON INQUIRY CARD

manner proves much faster than recalculating them each time they are needed.)

The CPU board can access graphics objects in either the visible-display or remaining portion of the frame buffer via the graphics board's four pairs of X, Y registers, which permit immediate access to four objects. With only one reference to the graphics system, the processor can transfer a new operand via the data bus and a new X or Y address via the address

USING SIGGRAPH CORE PRIMITIVES TO SIMPLIFY GRAPHICS OPERATIONS

SIGGRAPH core primitives are higher level software commands that greatly simplify raster-scan graphics functions. As implemented on Forward Technology Corp.'s FT-1024 graphics board, commands similar to those shown in (A) can control a series of raster operations, speeding the generation of graphics symbols and objects. With a vector display, for example, implementing a command to rotate an object by 90 degrees requires manipulating mathematical functions using floating-point trigonometric calculations to produce the desired image. Using a core primitive command for a raster display, however, involves merely a shuffling operation that successively divides the picture in half—horizontally and

vertically—interchanging the diagonal segments of the display until the rotation is completed. No mathematical algorithms are required, and the process itself is highly recursive, simplifying programming.

A "rubber-band" line display is another graphics function that can be implemented on the FT-1024 using the SIGGRAPH primitives. A user simply moves the cursor on the display screen from a starting point—usually with a mouse or data tablet—and the line is continually redrawn between the starting and endpoints (B). The operation is guided by a very simple algorithm that uses a logical OR operation on successive display data blocks to draw the line.

(A) PLY2A.R

PLY2A.R

TEXT

CHRSIZ [WIDTH, HEIGHT]
CHRSPC [SPACE]
CLRMDL
DEFCLR

FILIND [INDEX]

FONT [INDEX]
LINING [INDEX]
LINSTL [INDEX]
NDCWD2

WINDOW

Draws a sequence of connected lines using absolute or relative coordinates.

Draws a defined number of current marker symbols at absolute or relative coordinates.

Displays a string of alphanumeric text. Specifies character size and space.

Sets the model used for color. Associates colors with color indexes using the current color model.

Specifies the polygon-fill index.

Sets the text-font index. Sets the line-color index.

Sets the line-style index. Transforms a point on the screen to the 2D world space.

Specifies the portion of the coordinate system to be viewed.

(B)

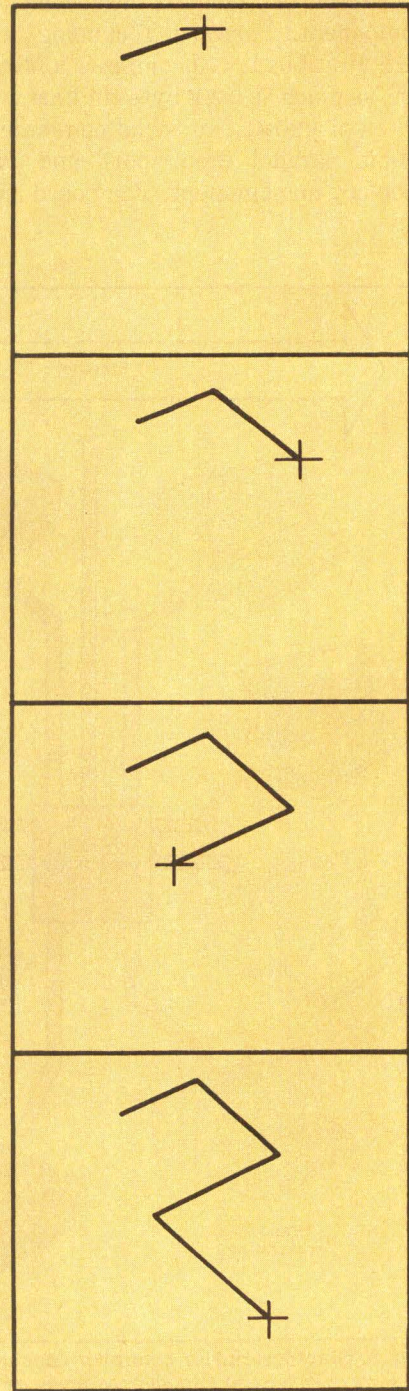

bus. At the same time, the processor can select whether to load an operand from the data bus or from the frame buffer, whether to use the mask or the source register and whether or not to execute a frame-buffer-update operation.

Integrating the CPU board

A 16-bit CPU board is the second key graphics-system component. Forward Technology's FT-68X 6¾-by-12-inch Multibus board combines a Motorola 68000 processor, as much as 256K bytes of RAM with byte parity, 64K bytes of PROM, two serial communications channels, a 16-bit parallel input port and two-level page and memory management. The board runs under Microsoft

Corp.'s XENIX-68 multiuser version of Bell Laboratories' UNIX operating system. Using XENIX-68, the board can run application programs written in C, FORTRAN, BASIC and Pascal high-level languages. Expansion encompassing Ada and Xerox Corp.'s Small Talk language is planned.

On-board RAM eliminates wait states

The inclusion of 256K bytes of RAM on the same board as the CPU has an important effect on system operation. It permits the 10-MHz 68000 to run programs at full speed without wait states, which would be needed if the RAM resided on a separate board and data had to be channeled through the Multibus interface's P1 connector. Using on-board memory, the 68000 can execute memory cycles, such as instruction fetches and read or write operations, every 500 nsec. Although it currently uses 64K RAMs, the board can accommodate future increases in RAM density. Memory can be further expanded by connecting a 768K-byte RAM board, which avoids wait states by linking through the P2 connector.

The Multibus, one of two buses on the FT-68X, references additional memory, the graphics processor and I/O devices. A second, internal synchronous bus communicates with on-board memory and other I/O devices. On-board accesses through the second bus free the Multibus to serve DMA devices or other CPUs, permitting true parallel processing in a multiprocessor environment.

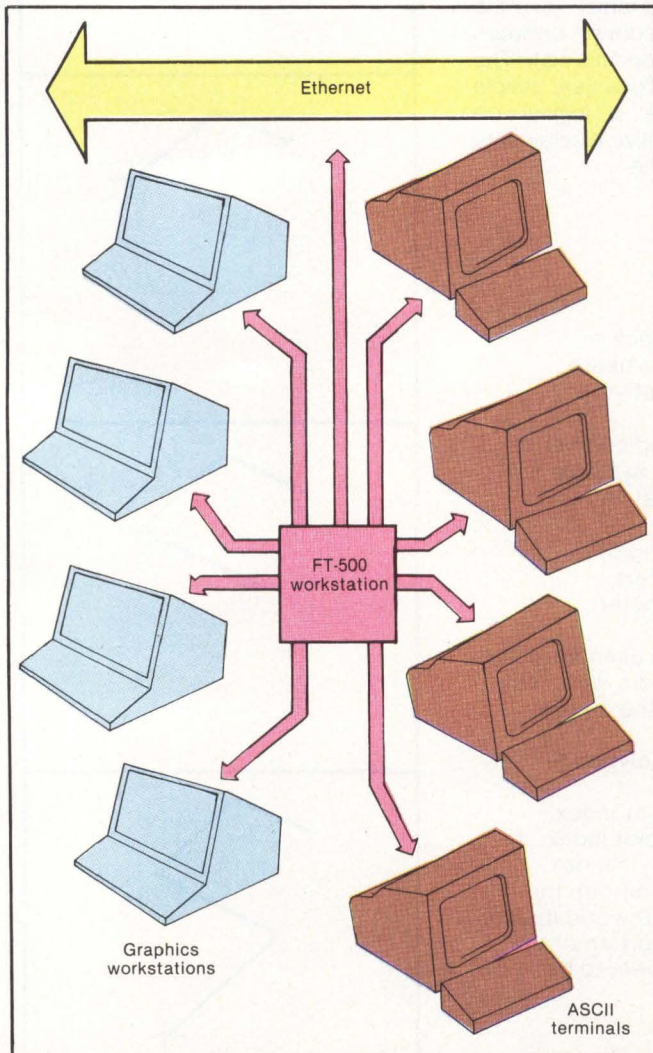

Fig. 3. Graphics cluster controller capability permits one FT-500 Gateway workstation to control as many as four other workstations. The unit can also function as a standalone node on an Ethernet local-area network.

HOW THE FT-68X MANAGES MEMORY

The FT-68X's memory-management unit (MMU) divides memory address space into 2K-byte pages. In the 24-bit addressing scheme, logical addresses are translated into physical addresses in a two-step process (see Figure). The first 11 address bits— A_0 to A_{10} —are within a page and therefore pass through the translation unmodified. The next 10 address bits— A_{11} to A_{20} —are subject to translation. Three bits— A_{21} to A_{23} —are reserved for special system functions and do not take part in the address translation.

In the first translation step, 10 bits of the logical address from the 68000 are combined with the 4-bit status information from the context register and translated via the segment map into a 6-bit virtual page address. The context register permits a system running multiple processes to switch between them without reloading state information relating to the translation of a particular process. The memory-management scheme can therefore

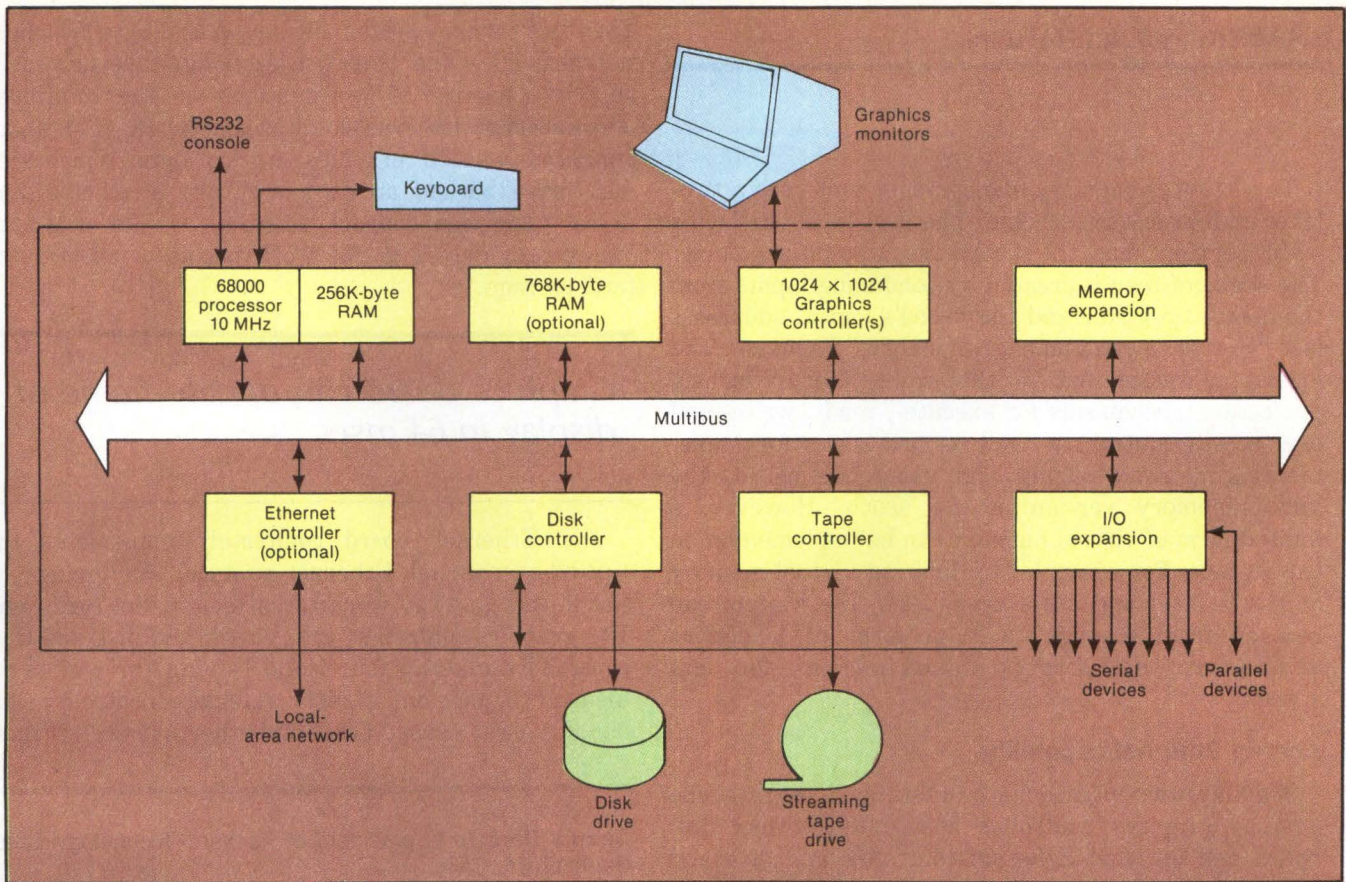

Fig. 4. An eight-slot card cage permits the workstation to accommodate optional Ethernet and interface controller boards as well as additional memory and other I/O devices.

map 16 distinct process translations simultaneously and access them by switching between the 16 portions of the segment map.

The 12-bit segment map reserves 2

bits. The other 10 bits (4 protection bits and the 6 most significant bits of the logical address) form a 1,024-entry table. The segment map outputs 6 virtual address bits and 4 protection

bits. The 6 virtual address bits can then create as many as 64 segments for the 1,024-by-16 page map, each with its own protection attributes. These segments can be shared by assigning them a common virtual address or kept private by giving each segment a unique virtual address. A logical segment can thus be as large as 2M bytes or as small as a 2,048-byte page.

In the second of the memory-management steps, the 6-bit virtual address and 4 protection bits per segment from the segment map combine with the 4 logical address bits from the 68000 in the page map. The page map translates these inputs—along with 2 bits of page-control information—into a 12-bit physical page address. The 12-bit page address joins with the 68000's 11 unmodified intra-page bits (A_0 to A_{10}) to form a 23-bit physical address. The MMU can designate each page of physical address as one of four types of address space—on-board memory space, Multibus memory space, Multibus I/O space or as representing a non-existing page.

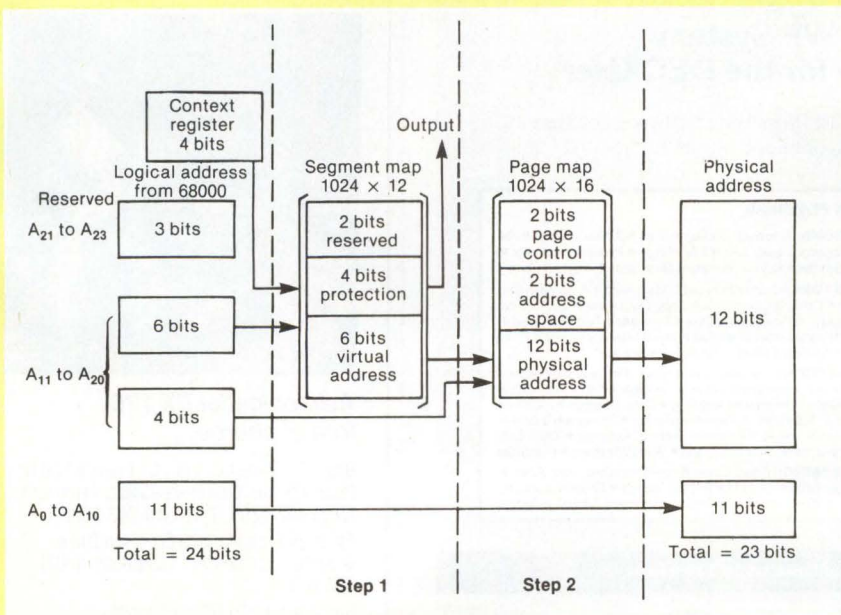

GRAPHIC WORKSTATION

The FT-68X's memory-management unit uses a two-level multiprocessor scheme. The first level employs a 12-bit segment map; the second uses a 16-bit page map. The segment map is created by combining inputs from the context register and the 68000's logical addresses (see "How the FT-68X manages memory," Page 220). The logical addresses fed to the segment map include protection mechanisms for execute-, read-, write- and user-access control, as well as provisions for implementing demand paging and using the 68010, the virtual-memory version of the 68000. However, a limited form of virtual memory can be implemented on the FT-68X. For example, by limiting virtual-memory access to load and store operations, the system can recover from a page fault, a form of load/store architecture that permits virtual memory for data spaces.

Adding Ethernet capability

The Gateway engineering workstation integrates the FT-1024 graphics controller board, the FT-68X CPU board and optional Ethernet-controller and disk and tape-controller boards into a powerful graphics system.

The basic turnkey system includes a 20M-byte Winchester disk drive and 20M-byte cartridge-tape drive. To support clusters of workstations or the multiuser demands of an Ethernet local-area network, (Fig. 3), an enhanced version provides an 80M-byte Winchester disk drive backed up by a 45M-byte streaming-tape drive. OEMs can connect as many as four 80M-byte Winchester drives to one workstation for 320M bytes total storage.

Graphics board can update frame of display in 64 msec.

The Ethernet board completely implements the 10M-bit-per-second Ethernet protocol, occupying one slot in the Gateway workstation's eight-slot card cage. The graphics controller, CPU board, and disk and tape controllers take up four slots, leaving three slots for memory expansion, a serial interface controller that handles eight RS232C ports and other functions (Fig. 4).

Dennis Daniels is president of Forward Technology Corp., Santa Clara, Calif.

Did Your PDP-11 Die

When you tried to run WORD PROCESSING?

Now There is a WP System Designed Specifically for the DEC User

With the WP Saturn Word Processing/List Processing Software, you have low overhead, quick response and power.

COME TO SATURN. FOR THE ANSWERS

- Faster and more powerful than the stand alones
- Faster and friendlier than other computer based systems
- Extensive help commands
- Saturn runs on RT-11/TSX, RSX, RSTS, IAS, VMS
- Saturn's ASCII Format interfaces to standard DEC files
- Assembler Language provides maximum speed and efficiency
- User Friendly Prompting helps you master word processing with minimal training
- Extensive List Processing; Forms, prompted data entry, and sort/select; plus flexible merging of lists and documents

WP SATURN FEATURES

FILE FUNCTIONS: Automatic backup • Uses ASCII source files • File directories location, type, date • File Merge • Password security • Print formatted file • Review formatted file • Store formatted file

SCREEN EDITOR: Advance-Forward & Backward • Automatic Carriage Return • Column Operations • Copy, Cut, Delete • Cursor Controlled • Display of Operator Actions • Formatted Text Displayed • Vertical and Horizontal Scroll • Load from another document • Paste • Prompts • Replace-Global or Selective • Search

TEXT FORMATTING: Automatic Hyphenation, Formula, User defined dictionary • Automatic Index & Table of Contents • Automatic Outline Formats, Outline, Decimal • Centering • Date Insertion • Multilevel Superscripts & Subscripts • Page Numbering • Paragraph Indent • Redefine Format Values • Reformat Without Retyping • Tabs, Left, Right, Any character • Variable Spacing • Word Wrapping • Footnotes

LIST PROCESSING: Form Generation • Prompted Data Entry • Multi-Key Sort/Select/Exclude • Record Search • Sequential, Binary • Unrestricted Field Insertion • Field replacement, Global, Selective

For additional information call toll free 1-800-328-6145

SATURN SYSTEMS

6875 Washington Avenue South, Suite 218, Edina, MN 55435 (612) 944-2452

CIRCLE NO. 107 ON INQUIRY CARD

Leister-Labor

the featherweight hot air tool for contactless soldering and unsoldering with the soldering nozzle of 2.5mm Ø.

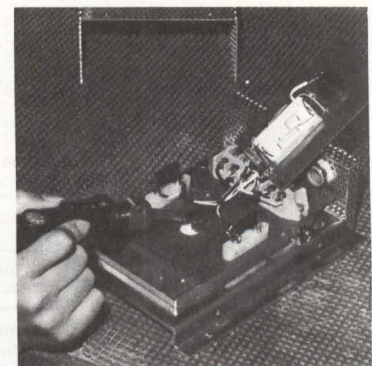

Ask for leaflet EX 176
free of charge.

Brian R. White Co. Inc., 313 Henry Station
Road / Ukiah, California 95482 Telephone:
(707) 462-9795, TWX 510-743-2052

Thomas Broberg, 529 Emersan Drive
Brandford CT 06405 / Telephone: (203)
481-5831

Karl Leister, CH-6056 Kägiswil /
Switzerland / Telex: 78 305

CIRCLE NO. 106 ON INQUIRY CARD

MINI-MICRO SYSTEMS/November 1983



*All Custom Modems
Are Not Created Equal.*

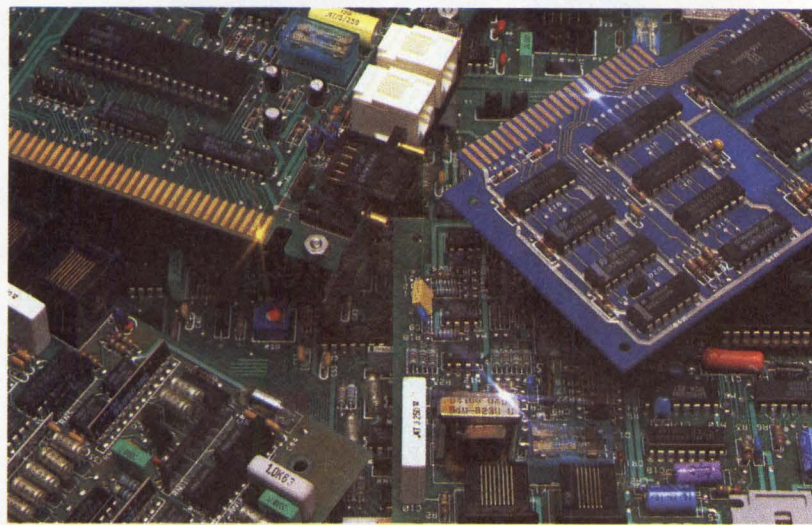

We Create Custom Designs to Meet Your Specific Needs.

We'll Save You Time, Money And Grief

There's a growing army of invisible Racal-Vadic custom modems out there. You can't see them because they're inside the world's leading computers and terminals.

Here's why we supply more custom modems to OEMs than the rest of the industry combined:

- We were building custom modems as far back as 1969.
- We invented the 1200 bps, full-duplex modem years before everyone else.
- We have more than 230,000

square feet of plant space with automated production and quality control.

- We're big enough to handle any size order.
- We've put together a custom management group that combines sales, engineering and production. This streamlined operation can deliver custom prototypes in 90 days with high-volume production close behind.

There's no doubt about it. Our custom modem group will save you time, money and grief.

Our Incredible Shrinking Modem

Imagine. A Bell-compatible 212A/103 low-powered intelligent modem on a 20-square-inch PC board. It has FCC and TAP certification, and UL approval. And by including a microprocessor, we can give you all the options you want — automatic dialing with stored numbers, interactive conversation with the terminal operator, and diagnostics that pinpoint problems anywhere in the network.

You specify it. We'll design and build it.

For more information, phone 800-543-3000, Operator 507.

Phone 800-543-3000,
Operator 507.

Racal-Vadic Member IDCMA

RACAL

1525 McCarthy Boulevard, Milpitas, CA 95035
Tel: (408) 946-2227 • TWX: 910-339-9297

CIRCLE NO. 108 ON INQUIRY CARD

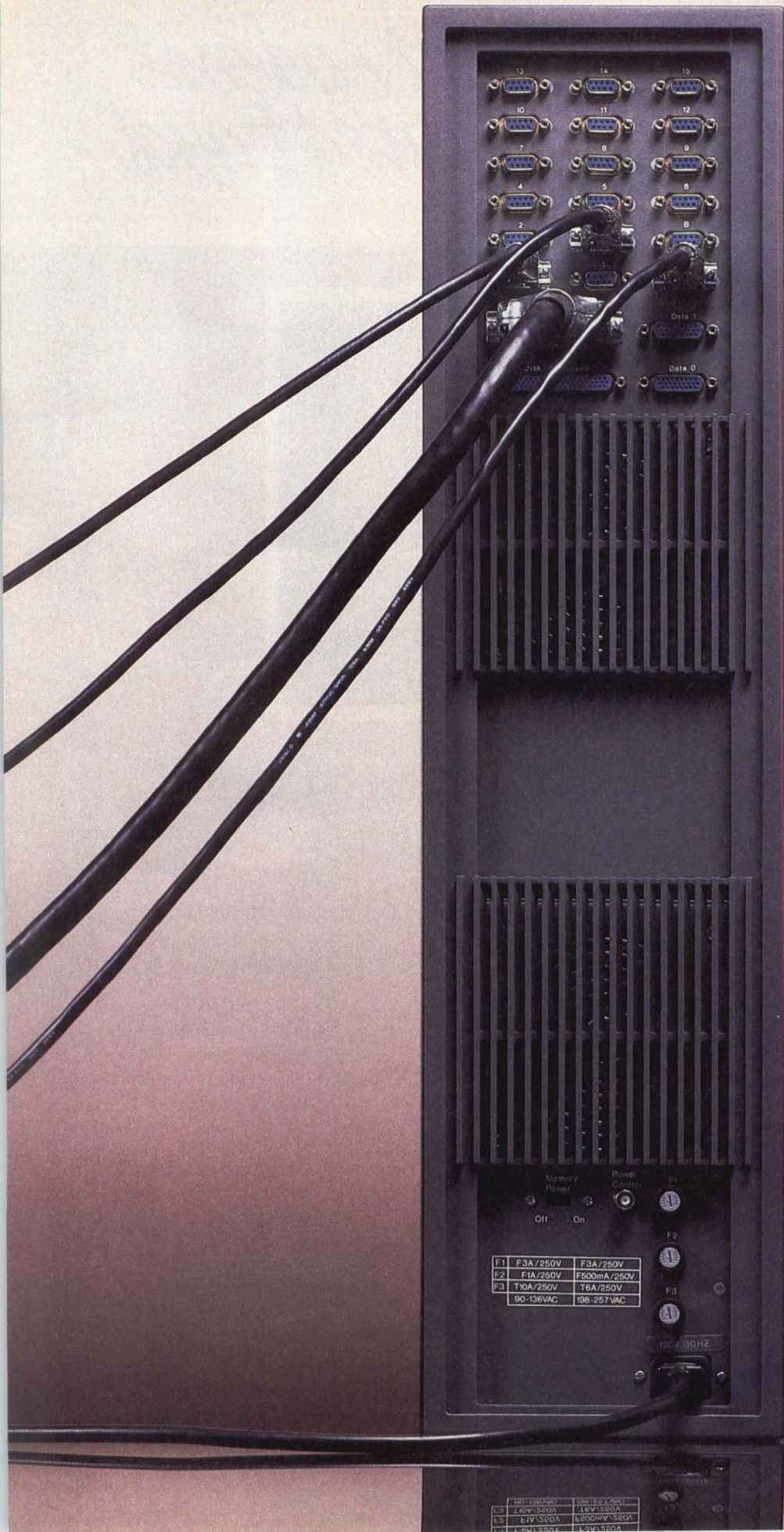

F1	F3A/250V	F3A/250V
F2	F1A/250V	F500mA/250V
F3	T10A/250V	T6A/250V
	90-136VAC	198-257VAC

0.7	1.0V/350A	1.6V/350A
0.5	1.0V/350A	1.6V/350A
0.5	1.0V/350A	1.6V/350A

TOWER 1632. YOU CAN REALLY GROW ATTACHED TO IT.

Tower™ 1632's nonproprietary peripheral connection flexibility is simply unsurpassed by any mini. Or micro.

Of course we offer an industry-standard bus, Multibus* IEEE-796. Of course we offer SA400, ST506, SMD and QIC II, so you can attach additional mass storage devices. And of course we support RS232C communications, ASCII TTY. And Bisync (2780/3780). Allowing Tower 1632 to connect and communicate with terminals, printers, mainframes, minis, personal computers and numerous special devices, from optical character and code readers to data tablet digitizers.

But our planning really pays off for you in our networking capabilities. Whatever standard you choose we can handle. From our UNET** peer network to SDLC/SNA, X.21/X.25, or Ethernet.***

Of course, we have a very good reason for offering all this flexibility. It's part of our commitment to providing OEMs with the prime requisite for success. A system built expressly for systems builders.

That's what we deliver. And that's the reason we tower over our competition.

Call us toll free at 1-800-222-1235 to learn more.

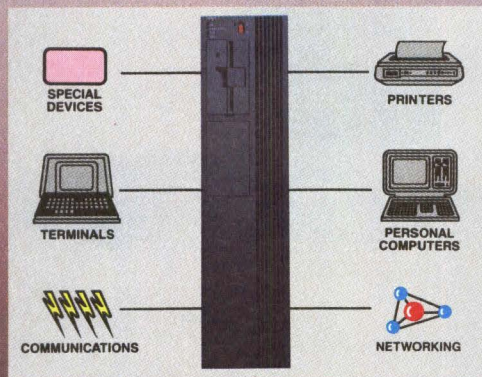

BUILT FOR SYSTEMS BUILDERS.
TOWER 1632.

NCR
OEM Marketing Division

NCR Corporation, World Headquarters, OEM Marketing Division, Dayton, OH 45479. Nationwide (800) 222-1235. In Ohio (513) 445-2380. In Canada (800) 268-3966.
*Multibus is a trademark of Intel Corporation. **UNET is a trademark of 3 Com Corporation. ***Ethernet is a trademark of Xerox Corporation.

CIRCLE NO. 109 ON INQUIRY CARD

Hitting higher reliability targets.

Some OEMs are accepting high failure rates from their 5¼" Winchester disk drive manufacturers. We don't think they should.

Some manufacturers consider 60% or 70% plug-and-play reliability acceptable. We don't.

Right now, we're hitting better than 98% plug-and-play reliability on our complete line of 12, 19, 26 and 40-megabyte drives. If you're getting reliability that's less than this, then you're not getting it from us.

By hitting higher reliability targets than anyone else, Computer Memories has become not only the industry capacity leader, but also the industry reliability leader. In fact, we now have more than a trillion bytes installed and operating beautifully. That's right, over a trillion!

Of course, we're not saying we're perfect. But with better than 98% reliability, we come close.

The capacity leader.

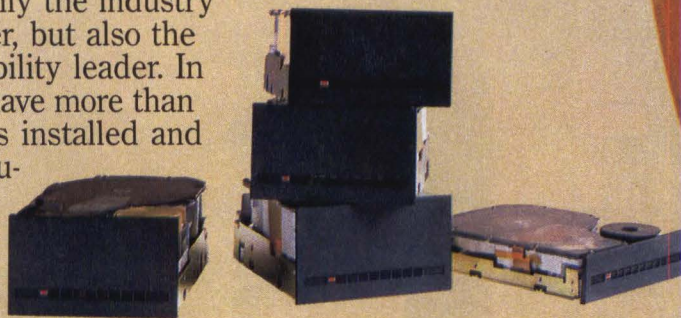

**Computer
Memories
Incorporated**

9216 Eton Avenue, Chatsworth, CA 91311 (213) 709-6445/
Ft. Worth, TX, (817) 332-7859/Costa Mesa, CA, (714)
241-9260/Springfield, MA, (413) 783-2386/In Europe:
Bray-on-Thames, Berks, UK, 06283-4281 Telex 847591.
For small quantities, call Schweber Electronics,
(800) 645-3040.

CIRCLE NO. 110 ON INQUIRY CARD

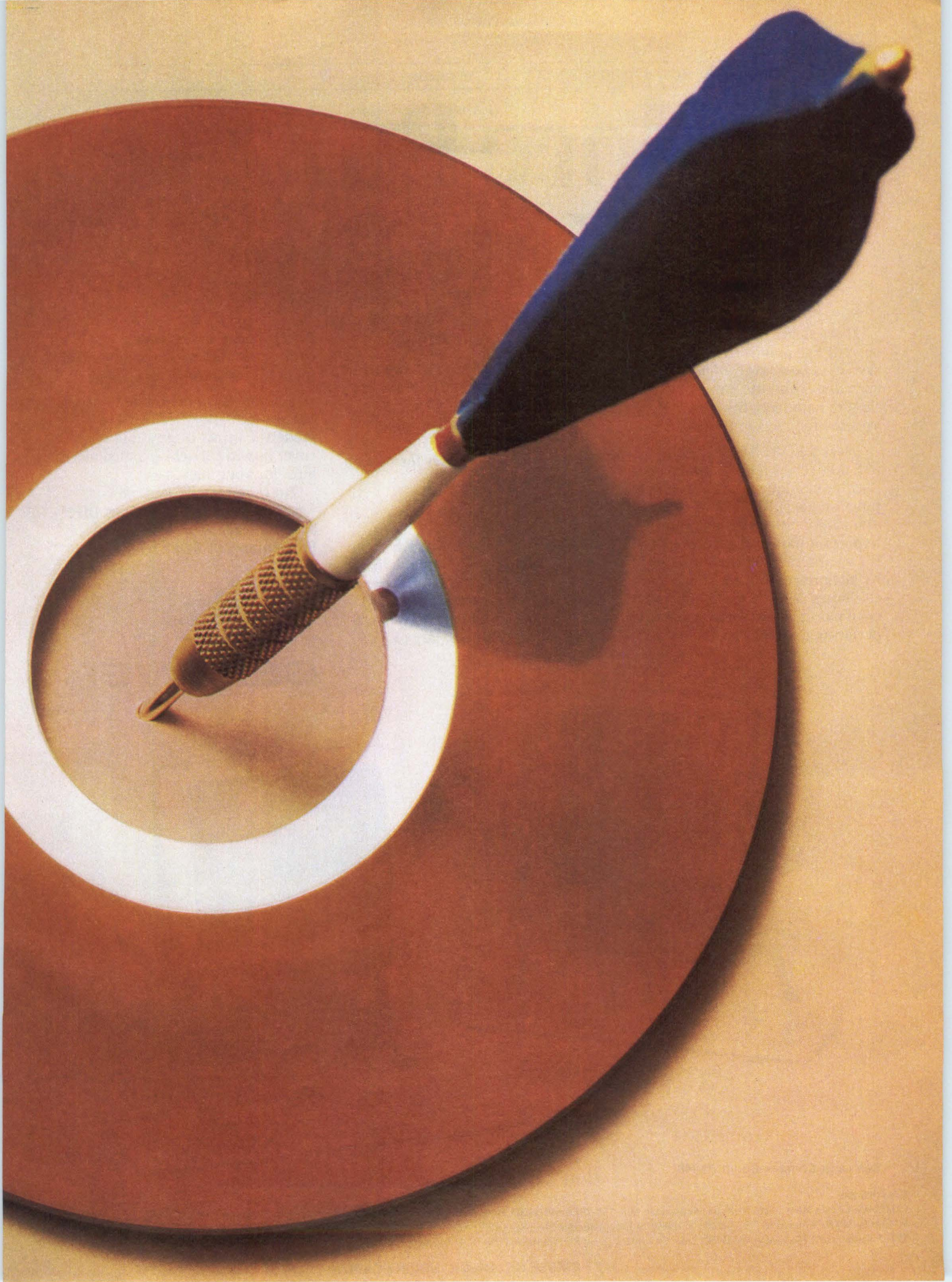

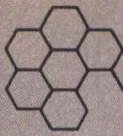

More Buzz For Your Buck

These smart terminals soar over current technology to bring your system to new levels of performance and economy. Naturally, they're both from the terminal/system architects at Beehive.

Users find the ATL-004 and ATL-008 very friendly, thanks to Beehive's unique multiple-use soft function keys. High-speed communication interfaces are another important part of the package. So is a swarm of additional productivity advantages and economic attributes. What's more, this powerful pair matches your price/performance needs precisely.

Fewer Bucks

Go with the ATL-004—Beehive's low-cost ANSI standard. Features include "user friendly" menu driven Terminal Configuration Manager (TCM) and VT-100 compatibility. This is one super forms data entry terminal!

More Buzz

The ATL-008 is ANSI X3.64 terminal with VT-100 compatibility as well. It incorporates a full screen Terminal Configuration Manager (TCM) and combines with remarkable editing features, large RAM/

ROM capacity for extended operations, and program download to provide maximum flexibility.

Get your system humming with either—or both—Beehive ATL models. Contact us now and discover how we'll deliver much more buzz for your buck.

For more details contact:
Beehive, 4910 Amelia Earhart Drive,
Salt Lake City, Utah 84125, Toll
Free Number: 1-800-453-9454.



BEEHIVE™



See us at Comdex-Booth #1448

Sales Offices:

CALIFORNIA Costa Mesa 714/540-8404, Sunnyvale 408/738-1560 • FLORIDA Hollywood 305/920-2711 • ILLINOIS Arlington Heights 312/593-1565
MASSACHUSETTS Woburn 617/933-0202 • MISSOURI Independence 816/356-4402 • NEW JERSEY Colonia 201/381-9883 • NORTH CAROLINA Greensboro 919/854-2694
TEXAS Dallas 214/239-3330 • UTAH Salt Lake City 801/355-6000 • WASHINGTON, DC (VA) Falls Church 703/573-1261

CIRCLE NO. 111 ON INQUIRY CARD

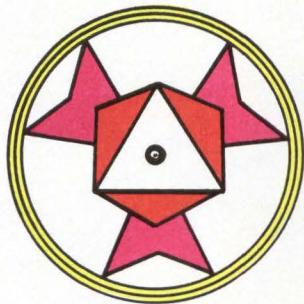

COMDEX™ Fall '83...

spotlights software products and trends

JESSE VICTOR, Associate Editor

Fifth annual small systems conference and exposition emphasizes major operating systems, key languages, systems and application packages

Software will hold the limelight when Comdex/Fall '83 convenes in Las Vegas, Nev., Nov. 28 through Dec. 2. More than 250 of the show's 1,500 exhibitors will be software or software-related companies. Many of the conference's 52 professional sessions will focus on key operating system (OS) trends, integrated microcomputer software packages, major and emerging languages, developments in local-area-network (LAN), database software and software interfaces for microcomputer-to-minicomputer or -to-mainframe connections.

A Monday afternoon session—"Operating System Trends: Ultimately UNIX?"—will track operating systems such as MS-DOS, CP/M, Bell Laboratories' UNIX, XENIX and "some other things that may come out by that time," says session leader Jean Yates, president of Yates Ventures, Los Altos, Calif. "We will look at where the overall winners are going to be in terms of market share, unit shipments and dollars."

Tracking OS standards

Yates does not see UNIX becoming the de facto standard for 16-bit systems. "Obviously, IBM's MS-DOS/

PC-DOS products are the de facto 16-bit standard," she asserts. "MS-DOS/PC-DOS is very much the OS of the single-user workstation. UNIX is a vehicle for making 16-bit minicomputer-type computers and applications available to microcomputer purchasers." What does Yates see as the main role for UNIX? "It's going to be very important for microcomputers-through-mainframes as a multiuser standard OS that vendors will offer in conjunction with a proprietary OS on the high end to give the end user access to the UNIX application-software library."

The session will explore the advantages and disadvantages of CP/M relative to MS-DOS and look into "ways to differentiate the product from PC-DOS," Yates adds. Yates does not agree with those who see a steadily declining role for CP/M in the next few years. "I think CP/M has a very viable position," she claims. But there is "some question as to where its niche will be. With more than 800 OEMs using it, it's not going away. You can be compatible with PC-DOS, offer CP/M and get some significant advantages that differentiate your product from the 8 zillion running on MS-DOS."

A significantly less sanguine view of available software will be offered by Rodney Zaks, president of Sybex Computer Books, Berkeley, Calif., in "Defacto Standards in the Micro Jungle." The Tuesday afternoon session will delve into the "demise of CP/M, the rise of IBM-enforced standards for operating systems, the significant demise of Pascal and the unlikely emergence of UNIX," according to Zaks. "It is very likely that we will see CP/M taper off and possibly slow drastically," Zaks asserts. "It is unlikely that any significant new computers will be introduced that will have CP/M compatibility."

Zaks sees PC-DOS or "possibly a proprietary OS that IBM might be introducing later on" as taking over CP/M's role. As for Pascal, "nobody is creating the programs that would have made it easy to use, effective or convenient," he insists. "Pascal at this point remains a development tool for engineers and an educational tool for universities. The growth phase of Pascal is also now terminated."

Questions of survival

As for highly-touted languages, Zaks views Ada primarily as a "long-range" tool for the military that also may "become quite well-used by development circles over the next five to 10 years." However, he does not foresee significant commercial applications within the next few years.

Zaks is also not optimistic about the prospects for UNIX. "UNIX so far has not made it," he contends. "And the hardware that would truly support the OS's capabilities is not truly available at this point. The large-scale use of UNIX as an operating system is very unlikely in the short term. UNIX remains very much wishful thinking in its admirers' eyes." Zaks thus expects MS-DOS and PC-DOS to capture the lion's share of the OS market, with UNIX emerging perhaps sometime down the road on faster machines that can more effectively use its capabilities.

In related session coverage, James Dow, president of Microcom Inc., Norwood, Mass., will discuss the recently-introduced Microcom Networking Protocol (MNP) and the general role of communications standards and protocols. Following the International Standards Organization (ISO) model, MNP serves file transfer among microcomputers, minicomputers, mainframes and computer networks. "I see it becoming the de facto standard for dial-up communications," Dow says. He expects VisiCorp, Microcom, Apple Computer Inc., Lotus Development Corp. and several other companies to standardize on the protocol soon. He thus sees the use of three sets of communications protocols serving different kinds of end-user requirements, with

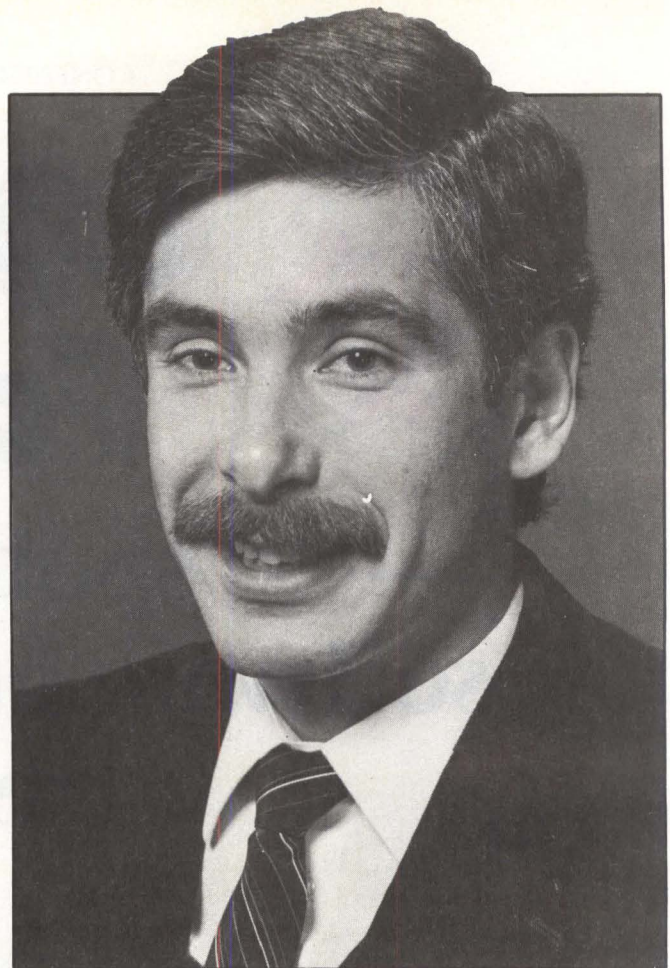

"It is unlikely that any significant computers will be introduced that will have CP/M compatibility," says Rodney Zaks, president of Sybex Computer Books.

MNP supplementing IBM Corp.'s System Network Architecture (SNA) and a LAN protocol. "Whatever IBM announces as its LAN will become one of the LAN standards," Dow says, "with possibly Ethernet as the other."

Focusing on integrated software

Integrated software packages will not be neglected by Comdex/Fall '83. Another Tuesday afternoon session—"Integrated Microsoftware Packages: Do They Deliver?"—will zero in on innovative products such as VisiCorp's Visi^{On}, Lotus 1-2-3, and Apple Lisa-type packages, says session chairman Brant Corenson. President of Enlon Associates, Cupertino, Calif., Corenson expects the coverage to delve into current and future products in two categories: first, lower-level systems that do not require a hard disk and don't offer features such as multiwindowing, graphics and a pointing device and, second, higher-end packages that include these capabilities.

Corenson, however, sees some obstacles to widespread use of integrated software products by middle- and higher-level managers in Fortune 500 companies. They will "probably not use Lisa- or Visi^{On}-type systems on a personal computer in an individual office,"

Changing our ribbon is a snap.

Most printers make you fool with a messy ribbon.

But with Digital's Letterprinter 100, all you have to do is snap in one of our replacement cartridges.

You'll instantly get at least 5 million more characters' worth of ink.

Easy, isn't it?

The fact is, everything about the Letterprinter 100 is easy.

For example, with just a flick of a finger you can select up to five different typefaces. Or let your computer do it for you, automatically.

If you can't find a typeface you like, we'll customize one for you.

Now why would the world's second largest computer company go to such lengths to make the Letterprinter 100 so accommodating?

Simply so it can spend more time doing what you bought it to do in the first place.

And that's printing crisp, clear manuscripts and graphics. From letter-quality like you see here for word processing, to high speed printing so you can get a draft page in only 10 seconds.

The Letterprinter 100 works with any of

Digital's personal computers or video terminals. And it's a snap to use.

See the whole family of Digital's Printers, including the daisy-wheel LQP02 and the low cost Personal Printer, the LA50.

For the distributor nearest you, call 1-800-DIGITAL, extension 700.

Or write Digital Equipment Corporation, Terminals Product Group, 2 Mt. Royal Avenue, UP01-5, Marlboro, MA 01752.



digital

CIRCLE NO. 112 ON INQUIRY CARD

ON SAVE UP TO 45%
ON CONTROLLER BOARDS.
HURRY! OFFER ENDS DEC. 31.
SEE US AT COMDEX BOOTH 2736
OR CALL FOR DETAILS.

Now For UNIBUS,[®] MTI Presents Two Totally Transparent Disk Controllers

ML11 for Winchesters—emulates RL02 and more. This quad-size board delivers up to 30% higher storage density on an 8" disk. For enhanced data integrity, ECC is 56-bits. Includes efficient defect sector mapping with one additional sector per track.

MX22 for floppies—emulates RX02, 03 and more. It can intermix and control up to four 5-1/4" and-or 8" drives with a single quad-size board. Features built-in diagnostics with LED display.

As you can't see, Micro Technology's newest transparent controllers are completely DEC[®] compatible in form, fit and function. Your Unibus-based system won't notice any difference in hardware or software (diagnostics, operating systems or application programs). But you'll spot major advantages in price.* And performance. Take a closer look.

See the jumper-selectable features—write precompensation enable/disable, alternate address/vector selection and device interrupt priority selection level. And don't overlook the built-in bootstrap capability.

We can give you an even better look.

Upon request, we'll include information on our

comprehensive line of DEC compatibles—more than 20 products, including Q-bus[®] controllers as well as complete subsystems with controllers and drives. All reliably built, competitively priced.* Call or write now for a clearer view of your DEC alternatives.

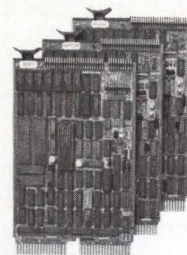

*Save up to 15% on all standard products. In addition, all orders (from 1-99 pieces) placed and delivered before 12/31/83, will be discounted at the 100-piece price.

Unibus, Q-bus and DEC are registered trademarks of Digital Equipment Corporation.

Micro Technology, Inc.

Micro Technology, Inc. • 1620 Miraloma Avenue • Placentia, CA 92670 • Telephone: (714) 632-7580

CIRCLE NO. 113 ON INQUIRY CARD

he says, but might use them on the departmental level. "The main problem right now is the price. It's too high. The other problem is that IBM hasn't introduced anything yet. And, until they do, corporate acceptance of these products will not be that rapid." Corenson expects IBM, as in many other markets, eventually to call the tune for integrated software products.

The session will also focus on the three levels of integration these packages offer. The lowest-level products integrate and translate file formats; the next-level products, which include packages such as Context Management Systems' MBA and Lotus' 1-2-3, have common instructions from one package to another. The top-line products provide several levels of software with a high-level user interface, graphics and a mouse for data entry. The highest-level products, Corenson says, are "object-oriented systems," such as Xerox Corp.'s Small Talk, in which the "operating system and applications are in one common area, and you add additional applications by adding objects to the system."

Databases and LANs also considered

Developments in database software and the role IBM and AT&T will play in the small computer systems market will be tracked by two Comdex/Fall '83 sessions. Wednesday morning, "Doing More Database Business" will consider the role of database software in multiuser systems, the split between menu-driven and procedural packages and the use of database software in multiuser LANs. This application, however, remains problematic, contends session participant Adam Green, president of Softwarebank Inc., Arlington, Mass. "LANs don't really exist as far as I am concerned,"



Comdex/Fall '83 is expected to attract 1,500 exhibitors.



"We will look at where the overall winners are going to be in terms of market share, unit shipments and dollars," says Jean Yates, president of Yates Ventures.

Green says. "There are a lot of people advertising them. There are some people who have them. But they are a hardware solution. The software is not there yet."

In this regard, file access can be a problem on multiuser systems, Green cautions. "Right now, you can get 10 different personal computers on one hard disk and call that an LAN. But you'd better make sure they don't try to get the same file at the same time. That would be a big problem." An even bigger problem,



Many of the 52 professional sessions at Comdex/Fall '83 will focus on software matters.

he contends, is that network capabilities are not being fully used. "Networks are treated as a shared hard disk, but they are not sharing files, which is the key point to networks. There is no application software available that will let users share files." A user could write it in assembly language or C, Green says, but "there is no way an end user can just pick up a database program and take advantage of a network."

Despite these problems, Green predicts a "tremendous growth" for the database market over the next few years. "The number of people who will want databases is going to be huge," he says. "The number of people who can use spreadsheets is limited to maybe half a million. But people who need databases include anyone who deals with information—which is what most of the country is doing right now."

Predicting small systems trends

Computer system developments and peripherals coverage, the core of most industry trade shows, will also be in the spotlight at Comdex. A Thursday

morning session, for example, will predict the shape of tomorrow's microcomputer and minicomputer markets. Tuesday afternoon coverage, "Tracking Disk Developments," will follow significant trends, as will a related Thursday morning session. Another session, "Small Systems Markets," will track "the most recent trends and price/performance ratios, rapid price degradations and the use of added value to differentiate one small system from another," reports session co-chairman Jean Yates. "We will look at the key players, who is winning in terms of units shipped and the general impact IBM and AT&T are having on the market" for computer systems selling for less than \$150,000. The Tuesday afternoon session will also focus on developments in office automation.

Yates foresees IBM's entry into the small systems market as having a devastating impact, forcing many of the weaker contenders to drop out over the next few years. "As the hockey-stick growth curve levels out," Yates says, "I see a precipitous trend toward mergers, acquisitions and bankruptcies." Yates expects AT&T, for its part, to come on strong in the office-automation market. "They will certainly be a major contender because they will try to sell computers to the phone-purchasing people in the big Fortune 100 companies and thereby combat IBM. In office automation, there is going to be a knock-down, drag-out fight between IBM and AT&T for control of the office." □

IMPROVING SOFTWARE RELIABILITY

Jack Scanlon, vice president, processor and software systems division, Western Electric Co., looks at computer and communications software from a telephone professional's perspective and doesn't like what he sees. "Downtime due to software problems will have to be reduced by two orders of magnitude to be acceptable. Hardware today is sufficiently reliable, but software is not. Reliability is becoming more of a software than a hardware issue."

Comparing computer systems to the dial-up telephone network, Scanlon notes that a computer system running 24 hours a day with an average uptime of 99 percent will be down for several hours a week. That's "actually very poor reliability" when important business decisions or Defense Department decisions may hang in the balance. "Ninety-nine percent uptime is totally unacceptable. Ninety-nine percent is only as good as Ivory soap. We need 99.99 percent or better." The dial-up phone system, Scanlon contends, has achieved a downtime of only 2 minutes a year.

Co-keynoter for the Comdex/Fall '83 show with William Gates, president of Microsoft Corp., Scanlon sees

serious problems with software reusability and programmer productivity. "Half of all the time spent by programmers is spent redoing things that have already been done for a new environment," he asserts. "That is totally unacceptable." The solution? Portable operating systems such as UNIX and portable compilers such as C.

However, Scanlon points out that languages such as Ada with strong typing and other requirements in regard to program structure will reduce programming and debugging and thus serve to boost programmer productivity.

Computer systems that can talk to any other system without a performance penalty are also a necessity, Scanlon says. In most systems, the use of networking can cut performance by 25 percent, compared to no loss of performance for the telephone system. "When you call someone over the dial-up phone network, you don't have to worry about what kind of equipment they have or over what path the signals can travel." Scanlon says. "For computers to become ubiquitous, the same kind of network integration is required." There are also too many protocols in use, and

the ones being used are inefficient. The solution? Reduce the number of protocols and put the protocols themselves into silicon.

Scanlon foresees a "continuing marriage of software designers and silicon designers" as more and more software, including high-level languages, becomes embedded in silicon. To use all the components on tomorrow's chips fully and efficiently, Scanlon says, software designers will have to become involved in chip design. If they don't, manufacturers will turn out very dense chips that "don't do what the software designer wants them to do." Putting software in silicon is also "the only way to get costs down to acceptable levels," he says.

Finally, Scanlon sees "environmental robustness" as a major issue for computer systems—and a major shortcoming when they are compared to the telephone network. The phone network, he notes, continues to function in the face of power outages, major storms and lightning and other environmental extremes. In contrast, Scanlon points out, computers still require narrow humidity and temperature ranges.

The matrix printer warranted 25 miles longer.

Some companies warrant their matrix printers for 90 days. Some 180 days. A few for a year. None longer. None except Dataproducts.

We stand behind our M-120 and M-200 printers for two full years.

That's miles of memos. Acres of spread sheets. Mountains of reports. Twice as long as anybody.

The only million-year warranty on the part that prints.

As if a 2-year warranty on the entire printer weren't enough, we back the patented M-120/200 printhead forever.

If it ever fails, even if it simply falls out of specifications, send it back.

We'll give you a new one.

Keep the customer satisfied.

More than anything, end users want reliability in their printers. Dataproducts designed reliability into the M-Series. We build it in.

And we're not the only ones who



The only 2-year OEM warranty in the business.

think so. After grueling evaluations, some of the biggest, most demanding OEM's in the industry chose Dataproducts matrix printers for their systems.

More than 40,000 have already been delivered.

Printers that help you compete.

Dataproducts matrix printers aren't just built well. They're built smart—for maximum productivity and minimum cost of ownership.

They're easy to use.

Sophisticated diagnostics make problems easy to locate and correct. Maintenance is virtually nil. And they're available for quick delivery at very competitive prices.

Depend on the world leader.

Dataproducts is the world's largest independent manufacturer of com-

puter printers. We build our matrix printers to the same stringent standards we set for all our printers, including our most advanced high-speed printers.

To learn more, phone (213) 887-3924 or send

the coupon below.



The M-120 prints at 180 CPS.

The M-200 prints at 340 CPS.



MMS/11-83

I'd like to know more about a matrix printer so good it's warranted 2 years. Send details.

I'm shopping for printers now. Send a rep.

Name _____

Title _____

Company _____

Type of business _____

Address _____

City _____ State _____ Zip _____

Telephone _____ Ext _____

Dataproducts is a registered trademark. M-120 and M-200 are trademarks of Dataproducts Corporation.

DATAPRODUCTS

The Printer Company



Leapfrog



Holloway

to 32 bits!

The 32-Bit Advantage

For OEMs and system integrators, getting the jump on the competition means leapfrogging to the most advanced technology available. Today, that means making the jump to 32-bit architecture. Now, when it can give you a decisive advantage.

32-Bit Memory on a 32-Bit Bus

The Universe 68/05 is a true 32-bit system because it handles 32-bit data transfers in parallel on its 20Mb/sec VERSAbus, while most 68000-based machines are still limping along with 16-bit buses. With the next generation of processors (like the MC68020), a full 32-bit bus will be a requirement on *all* systems. VERSAbus is there now, and it's non-proprietary.

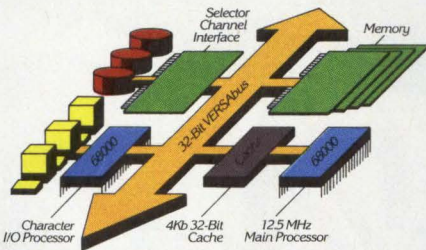

32-Bit Cache, 12.5MHz 68000

Our new Universe 68/05 is the first general-purpose computer built *and delivered* using the new 12.5MHz 68000 microprocessor. Its 4Kb 32-bit cache memory virtually eliminates wait states, while a separate 68000 I/O processor offloads the main 68000. Its MIPS rate—1.25 million instructions per second—outstrips a VAX 11/750 that costs several times as much.

UNOS is a trademark of Charles River Data Systems, Inc. UNIX is a trademark of Bell Laboratories. VERSAbus is a trademark of Motorola. VAX is a trademark of Digital Equipment Corporation.

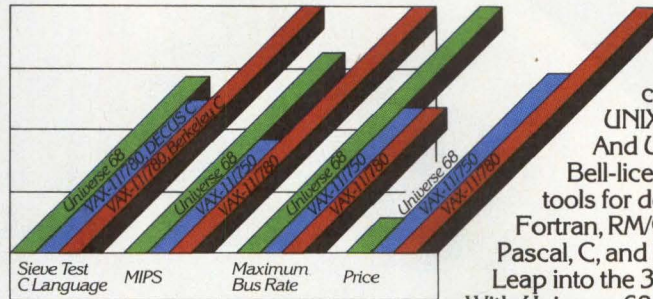

Universe 68 provides performance comparable to VAX, at a price far below VAX.

32/64-Bit Hardware Floating Point

Our new IEEE-format hardware floating point unit handles 32- and 64-bit operands fast. In fact, with floating point performance in the 40-50K flops range, it holds its own very nicely with VAX-level machines. Yet the Universe 68's price tag is only a fraction of a VAX's.

The First 32-Bit System Under \$10,000

The Universe 68/05's under-\$10,000 OEM-quantity-one price includes 32-bit central processor, 10Mb Winchester, 1.26Mb floppy, 256Kb RAM (expandable to 3Mb), and four serial I/O ports (expandable to 64). You can build multiterminal systems around a 68/05 at a cost-per-user that will embarrass workstation systems. For even more horsepower and expandability, you can hop over to the compatible Universe 68/37 or 47.

The 32-Bit, Real-Time, Bell UNIX

UNOS, our multi-user, multi-language

operating system, brings real-time, transaction-oriented capabilities to the UNIX-compatible world. And UNOS now runs Bell-licensed UNIX System III tools for development. Plus Fortran, RM/COBOL, BASIC, Pascal, C, and DBMS. Leap into the 32-bit future now. With Universe 68 from Charles River Data Systems.

UNIXTM

NOW RUNS ON

UNOSTM

MM11

Send me "The Insider's Guide to the Universe," an informative 24-page discussion of the technical concepts behind the Universe 68 family of computers.

Have a sales engineer call.

Name _____

Company _____

Address _____

City _____ State _____ Zip _____

Telephone _____

Return to Charles River Data Systems,
983 Concord St., Framingham, MA 01701
(617) 655-1800



CHARLES RIVER DATA SYSTEMS

CIRCLE NO. 115 ON INQUIRY CARD

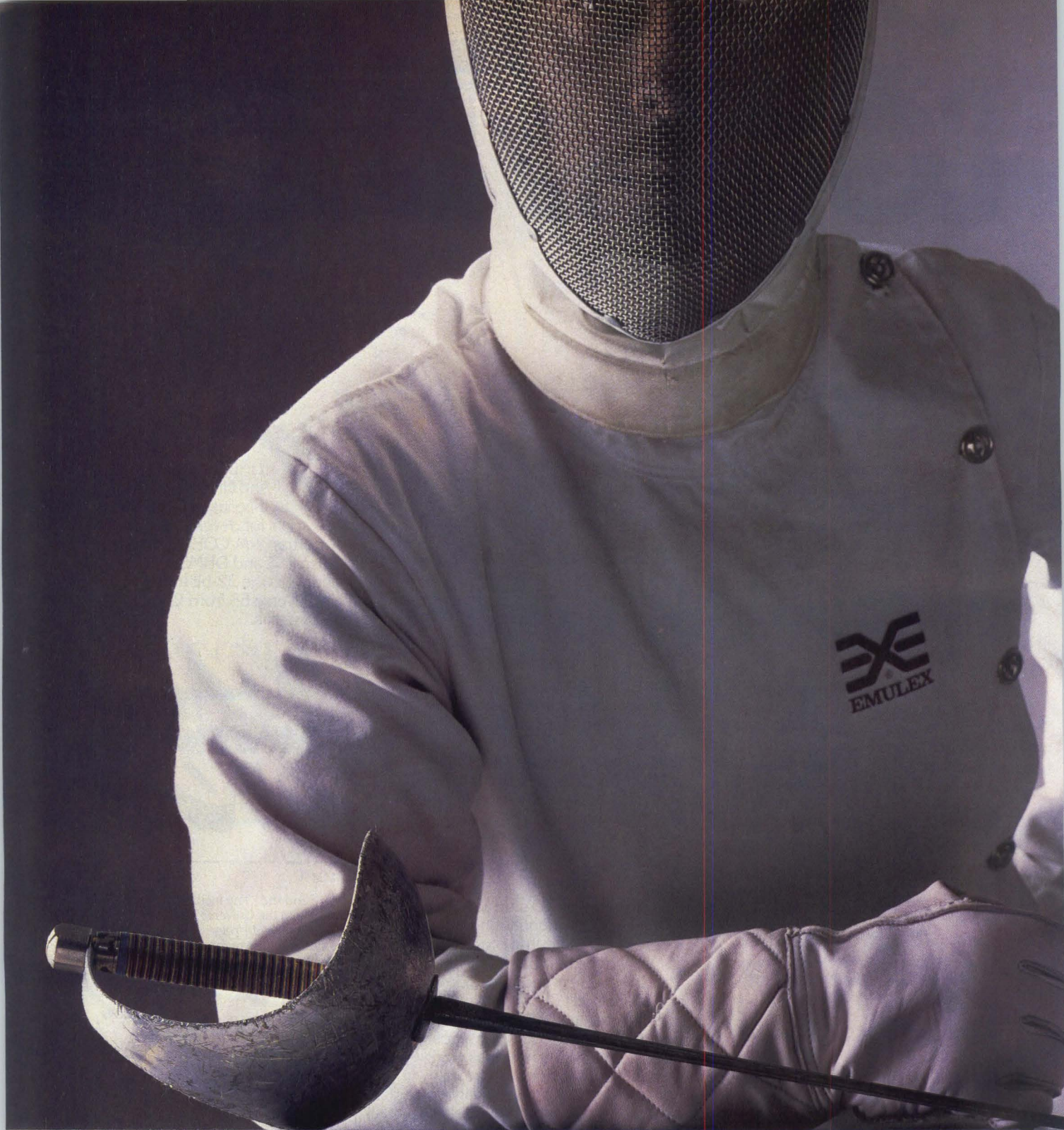

EMULEX



SABRE

Realizziamo la tua idea

Storage and backup problems on your QBus? SABRE™ has a sharp solution.

SABRE™ is a cut above anything on the market. It's a new concept in high-capacity, high-performance mass storage. A 5¼" Winchester/cartridge disk package for use with operating systems that run on DEC LSI-11 through 11/23+ microcomputers. SABRE's an innovative, RL02 software transparent storage alternative that puts 41.6 Mbytes on-line and delivers balanced backup through a versatile, removable cartridge disk. All in a compact, rack-mountable package.

Standard interfaces/transparent software.

SABRE hits the mark for reliable, high-speed, low-cost storage with convenient, efficient backup. Its UC01 host adapter plugs into any single-quad width QBus slot, and provides the Small Computer System Interface (SCSI) system-level bus for SABRE and up to five additional I/O devices. Through exact RL02 emulation, SABRE runs existing operating and diagnostic software as is. With logical RL02 images on both the fixed and removable media drives, volume backup is a snap.

Hard disk backup performance.

The ruggedized cartridge drive provides hard disk backup performance and reliability. Many times faster than either floppies or tape, it also provides the versatility to handle program entry, data storage and can function as a system disk. Overall, the 5¼" Winchester/cartridge disk combination gives system-level performance which *exceeds* multiple RL02's in many applications.

Efficient system packaging.

Space-saving SABRE is 5¼" high, slips into any standard 19" Retma enclosure and comes complete with power supply, host adapter and connecting cables. It needs one-eighth the space and draws one-quarter of the power of four RL02's. Further, SABRE slashes hardware and installation costs by eliminating the need for a separate system bootstrap, bus terminator and clock control board.

For more information on SABRE or any of the high-quality Emulex communications, disk, tape and packaged subsystem products, call toll-free (800) 854-7112. In California (714) 662-5600.

SABRE's Features

Size	Compact 5¼" height x 19" width package contains 31.2 MB (3x RL02) 5¼" Winchester disk and 10.4 MB (1x RL02) removable 8" cartridge disk.
Capacity	Equivalent to four (4) DEC RL02's.
Speed	Overall performance significantly increased over tape and floppies, especially in throughput and backup time.
Transparency	Runs standard RL02 diagnostics and operating software.
Flexibility	Removable cartridge disk; SCSI Bus interface allows up to five (5) I/O devices; single-board host adapter.
Reliability/Durability	Winchester technology; ruggedized cartridge disk construction; shock mounts; hermetically sealed HDA for protection against contamination.
Price/Performance	Lower cost per box and per MB in virtually all applications.

GSA Contract #: GSOOK8401S5575 *SABRE is a trademark of Emulex Corporation. DEC, LSI and QBus are trademarks of Digital Equipment Corporation.

See SABRE and Other Exciting
New Emulex Products at Comdex Booth #2030.



3545 Harbor Blvd., P.O. Box 6725,
Costa Mesa, California 92626.

The genuine alternative.

CIRCLE NO. 116 ON INQUIRY CARD

Give us an audition for diskette duplication.

Save 10% on the encore.

In diskette duplication, we upstage all our competitors. Because, as a Verbatim company, we have complete control over the entire process, from raw materials to packaging and inventorying. Our quality and consistency has earned us rave reviews from some of the biggest names in software.

Right now, as an added incentive to try us, we're making a special money-saving offer. First, give us an audition with a minimum 1,000 piece order. We're confident you'll like the results so much, you'll want to use us regularly. So, on your second order, we'll give you a 10% discount on the duplication service. If you also order serialization or copy protection, we'll trim 10% off the cost of these services as well.

To qualify for this offer, send the coupon or call 800-872-8778.* See why a Data Encore performance is such a tough act to follow.

*In California or outside the United States call (408) 773-0114.

10%
off an Encore
performance.

Mail to: Data Encore, 585 N. Mary Ave., Sunnyvale, CA 94086

Yes, I'm interested in saving 10% on an Encore performance. Please contact me as soon as possible:

NAME _____

TITLE _____

COMPANY _____

ADDRESS _____

CITY _____ STATE _____

ZIP _____

OFFER EXPIRES 12/31/93

Data Encore
A Verbatim Company

10M-bps LAN combines benefits of CSMA/CD and token passing

ASHRAF M. DAHOD, Applitek Corp.

LAN factors	Access method	
	CSMA/CD	Token passing
Maximum device-to-device distance:		
Less than 5 miles	✓	✓
Greater than 5 miles		
Types of devices:		
Intelligent	✓	✓
Non-intelligent		✓
Asynchronous	✓	
Synchronous	✓	
Short bursty messages	✓	✓
Long bursty messages	✓	
Fixed-length bursty messages	✓	
Short regular messages	✓	
Long regular messages (file transfers)		✓
Fixed length regular messages		✓
System requirements:		
No central controller	✓	✓
Known transmission delay	✓	✓
Unbounded, highly variable transmission delay is acceptable		✓
Tightly synchronized operations needed	✓	
Digitized voice support needed		✓
Ratio of peak system load* to system capacity:		
Less than 40%	✓	✓
Less than 60%	✓	
More than 60%		✓

* (Number of devices × data bit rate per device × message frequency per device)

Choosing a local-area network (LAN) for a multivendor, multitasking computer environment presents a dilemma: two common access methods are available. They are carrier sense multiple access/collision detection (CSMA/CD), most effective in networks with non-intelligent devices generating infrequent, or "bursty," messages, and token passing, in networks with synchronous, intelligent devices transmitting frequent or regular messages. Applitek Corp.'s universal LAN (UniLAN) uses the UniLINK access method to combine the advantages of both access methods on one 10M bit-per-second network. UniLAN uses either broadband or baseband coaxial cable or fiber-optic cable and has modular software.

Common access methods offer advantages

An access method is a protocol that defines the rules granting a user-device entry to a data channel. CSMA/CD is a distributed contention technique that uses

Different access methods address different local-area network (LAN) requirements. While carrier sense multiple access/collision detection (CSMA/CD) and token passing are well-suited to particular LAN environments, Applitek's UniLINK access method accommodates all LAN requirements in each of the above categories by combining the benefits of CSMA/CD and token passing.

random access and variable message lengths. If two devices try to transmit at about the same time, they stop and wait a random amount of time before trying to send again. (Retransmission delays vary, depending on network load.) As more devices attempt to transmit, the number of collisions increases, and more network time is spent resolving them. Long or frequent messages, such as file transfers, could overload the network and cause serious delays. Therefore, CSMA/CD is more efficient on lightly-loaded networks with intermittent traffic and applications that require only short delays rather than guaranteed access. Guar-

*UniLINK access methods
serve multitasking, multivendor environments*

teed access means that, within a specified period of time, the system ensures that a device will be able to transmit.

Some applications, such as real-time digitized voice, require guaranteed access to the network. Token passing is the preferred method for these applications. The network passes a token from node to node. Because the node holding the token controls the medium for a pre-defined period of time, token-passing systems are effective for applications involving frequent or regular traffic and become inefficient if traffic is infrequent or irregular. Moreover, they sometimes require special administrative nodes to control traffic.

UniLINK combines advantages

UniLINK automatically adjusts to accommodate different types of devices and traffic loads. The network implicitly assigns a different number to each message. (A message is defined as the period during which a packet of information can be transmitted.) The messages can be of variable length. All devices on the network "know" the current message number and can transmit only during the message number assigned.

A message-number allocation process assigns numbers to the network interfaces on a dedicated or contention basis. A message number is dedicated if only one interface can use the number to send information through the network. A contention message number can be assigned to more than one interface; interfaces must "contend" for its use. As in CSMA/CD, when the sender detects a collision, it stops and waits a random length of time before trying to send again in a contention message number. However, if a sender's dedicated message number comes up before the random wait period is over, the sender uses that message number to transmit. Thus, if a node encounters a relatively large number of collisions, the message-number allocation process assigns a dedicated message number to that node. This procedure reduces the delays in conventional CSMA/CD systems. Also, a node can be given priority by assigning it more message numbers, depending on the amount of traffic generated at the node.

Allocation of message numbers to the network interfaces determines how UniLINK functions. If all message numbers are assigned on a contention basis, the network functions like a CSMA/CD network; if interfaces are assigned only dedicated message numbers, UniLINK functions like a token-passing network, the numbers acting as tokens. And, similarly, if both dedicated and contention numbers are used, UniLINK functions as a combination of the two. By assigning dedicated message numbers for synchronous and voice devices and contention message numbers for asynchro-

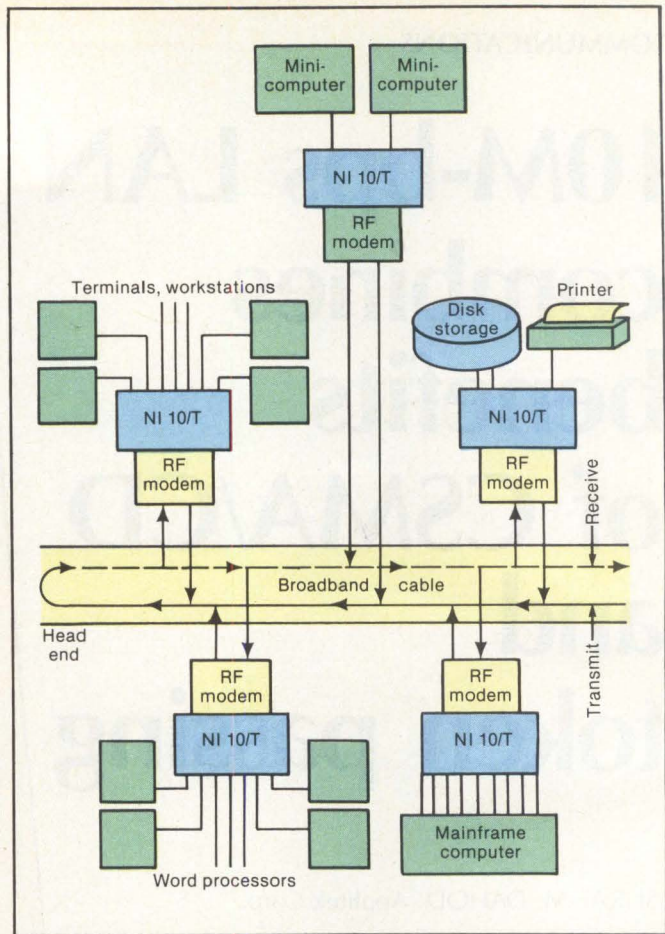

Fig. 1. UniLAN configuration with broadband cable. The network interface (NI 10/T) connects user devices to the cable via the Applitek RF modem. In a baseband system, a transceiver connects the network interface to the coaxial cable.

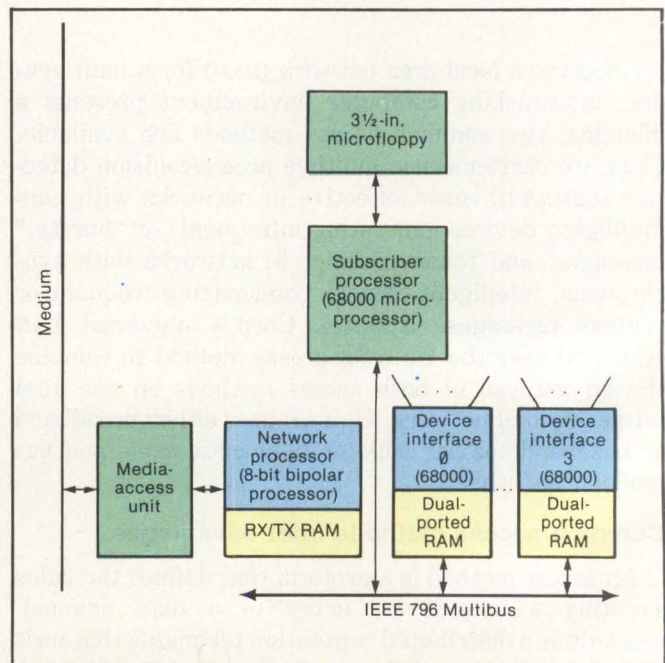



Fig. 2. The network interface consists of the media access unit; a network processor with firmware that implements the UniLINK access method, a receive/transmit (RX/TX) buffer with 8K bytes of RAM to receive packets and 4K bytes of RAM to store packets to be transmitted, a subscriber processor that checks message headers and as many as four device interfaces.



Pound for Pound, Stone for Stone
or Kilogram for Kilogram
The IBC Ensign™
Out Performs Them All.

68000 based computers are springing up all over the world. But, if you need a 16 bit microcomputer with performance to rival even the largest minicomputers, then you need the IBC Ensign, it out performs them all.

The Ensign is a high performance 16 bit microcomputer employing the most advanced VLSI techniques available along with the ultimate in expandability. The system features support for up to 32 users; up to 8M bytes of proprietary double bit ECC memory; over 1,000M bytes of SMD disk capacity; both cartridge and 9 track magnetic tape support; and operating system support for UNIX™ and OASIS-16™.

The above features along with our exclusive multi-slave microprocessor architecture, make the Ensign a super microcomputer. The system utilizes two slave micro's with a 16K byte buffer to handle all I/O. A third slave controls all disk and tape I/O. Another micro provides memory management with capabilities and speed significantly beyond industry standard MMU circuits. This leaves the 68000 CPU free to process at its full instruction speed without any wait states. The result is a microcomputer that rivals the largest minicomputers in performance and expandability.

End Users Circle No. 48 on Inquiry Card.

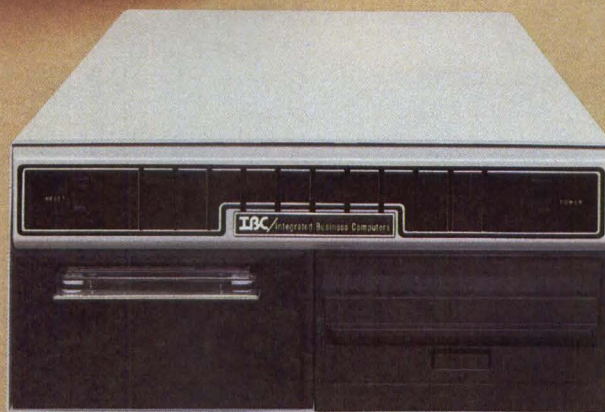

OEM's system integrators and dealers! To find out more about the IBC microcomputer that outperforms them all and the best discount schedule and dealer plan in the industry, please call or write:

See us at Comdex Booth #2872.

OUTSIDE THE USA

IBC / Integrated Business Computers

21592 Marilla Street
Chatsworth, CA 91311
(213) 882-9007 TELEX NO. 215349

WITHIN THE USA

IBC / DISTRIBUTION

1140 36th Street, Suite 212
Ogden, UTAH 84403
(801) 621-2294

UNIX is a trademark of Bell Laboratories
OASIS is a trademark of Phase One Systems

Dealers Circle No. 118 on Inquiry Card.

INTRODUCING

COLORPLOT™ II

Color Hard Copy with Line Printer Performance

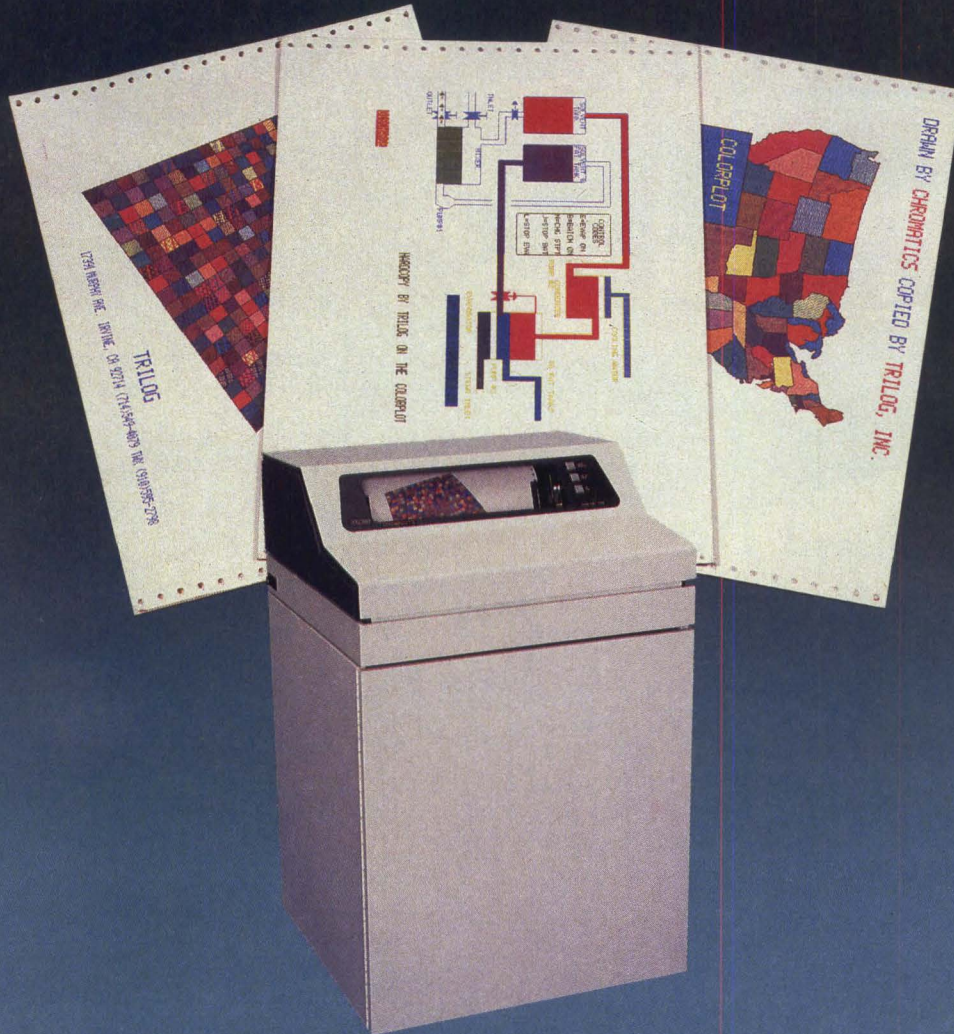

TRIOLOG's patented multicolor technology provides full color as well as conventional printing on plain fanfold paper at 100 dots per inch resolution.

COLORPLOT™ II provides CAD/CAM and/or business graphics hard copy in full color — quickly, reliably and accurately. With TRIOLOG'S TIP series of dot matrix line printers, there's no need to sacrifice anything. Available now are impact printers with all the quality, versatility and reliability that any mini/micro computer system needs.

With COLORPLOT™ II the extras are free:

- Full color hard copy output
- CAD/CAM graphics
- Business graphics
- Bar code generation
- Forms generation
- Data processing print @ 300 LPM
- Compressed print @ 220 LPM
- Letter quality print @ 75 LPM

And TRIOLOG puts it all into one printer with proven reliability from the pioneers of NON-STOP-PRINTING™.

COLORPLOT™ II is sold and supported through our worldwide distribution network.

For more information call or write today:

TRIOLOG, INC. 17391 MURPHY AVE., IRVINE, CA 92714
(714) 863-3033 TWX (910) 595-2798

TRIOLOG®

CIRCLE NO. 119 ON INQUIRY CARD

nous and bursty devices, the network concurrently provides guaranteed and shared access.

Message numbers are assigned either by the user or by an automatic allocation algorithm in each interface. In a large network, a network monitor unit can automatically perform message-number allocation and other network-management functions.

Network interfaces synchronize and keep track of message numbers as they pass by on the network, a process called "pacing." Any of the network interfaces can handle system pacing. When an interface comes on-line, it "listens" to the network. If no activity is detected, that node automatically assumes the pacer role. If two or more interfaces attempt to be the network pacer at once, collision occurs, and the interfaces shut off and wait a random period of time before trying again.

Each network interface has 16-bit message-number counter incremented at each message boundary. To ensure that the value of the counter is the same from device to device, the network pacer sends a message carrying the current message number. These block-synchronization messages are sent once every 1,024 messages.

Time delay is used when interfaces transmit, allow-

ing messages to line up end to end with no idle time between them. In a broadband system, each device computes its own time-delay parameter because each interface is at a different distance from the cable head end. The time-delay parameter establishes different loop delays for each node, depending on the distance from the cable head end.

Connecting the configuration

The media-access unit (MAU) connects the network interface to the network. In baseband systems, the MAU is an IEEE 802 baseband transceiver; in fiber-optic systems, the MAU is a baseband optical fiber tap. For broadband systems (Fig. 1), Applitek Corp. has developed a custom RF modem to act as the MAU. The modem follows IEEE 802 guidelines and offers 10M-bps operation in one 6-MHZ TV channel.

UniLAN can support more than 10,000 network interfaces, depending on the cable used. Each network interface (Fig. 2) consists of the MAU, a network processor, a subscriber processor and the device interface(s).

The network processor has an 8-bit bipolar processor with firmware to implement the UniLINK access method. A receive/transmit buffer has 8K bytes of odd-parity RAM to receive packets from the network and 4K bytes of odd-parity RAM to store packets to be transmitted. Its resettable first-in, first-out (FIFO) memory increases data throughput. The network processor Manchester encodes and decodes data in

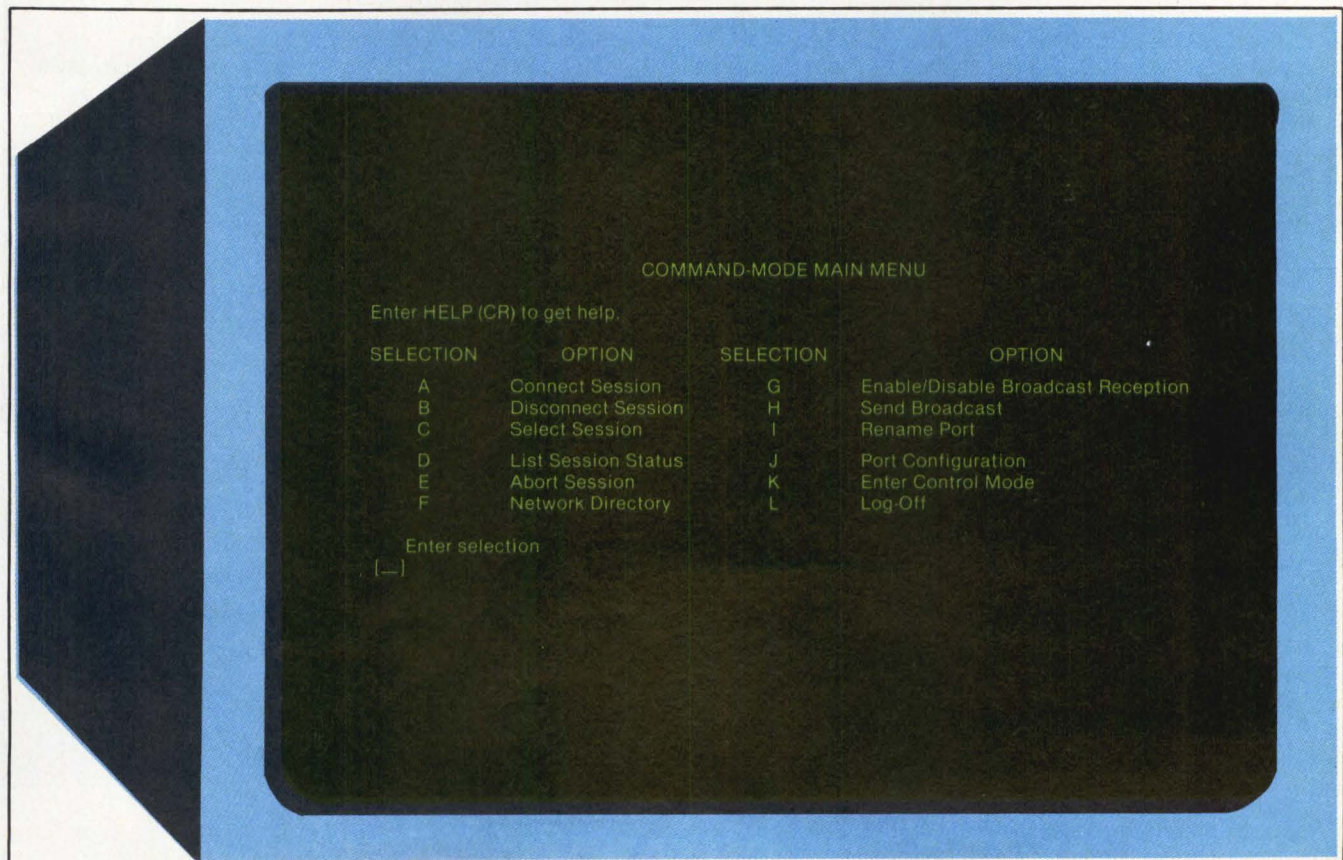

Fig. 3. The command mode main menu provides commands for configuring system devices.

baseband and optical fiber networks.

The subscriber processor is based on the Motorola 68000 microprocessor and handles as many as four device interfaces. A 3½-inch microfloppy drive connected to the subscriber processor stores programs and configuration parameters.

Connecting the 68000-based device interfaces to the subscriber processor is an IEEE-796 Multibus. Each device interface comes with 32K bytes of dual-ported RAM to store inbound and outbound packets, so that, while one packet is being assembled, another can be transmitted. Each device interface supports as many as eight RS232/449 asynchronous, bisynchronous or synchronous data-link-control (SDLC) devices. The network interface currently has eight ports for connecting user devices.

Tracking the data flow

The dual-ported RAM on the device interface stores data from a user. When a packet (message) is ready to be transmitted, the device interface informs the

subscriber processor, which sets up direct memory access (DMA) between the RAM and the transmit buffer. The network processor then sends the packet to the network through the MAU.

In "receive" direction, the MAU receives data from the network and stores it in a "receive" buffer. The subscriber processor checks the header and processes the data. If the packet is addressed to a device connected to the network interface, it sets up a DMA to move the packet into dual-ported RAM. The 68000 then takes the packet from RAM and ships it to the user.

Each component of the network interface runs its own diagnostics at power-up. The device interfaces put their local ports in loop-around mode. The subscriber processor checks them and sends test-pattern packets through the network processor and MAU and over the cable. If all diagnostics pass, the network processor becomes operational.

Modular software provides flexibility

UniLAN's software has an English-language command structure presented in menu form, and a HELP facility provides on-line support. Software creates virtual circuits, called "sessions," between devices, while error detection and control procedures assure the integrity of the data.

PLAYING BY THE RULES

The Open Systems Interconnection (OSI) reference model, defined by the International Standards Organization (ISO) in collaboration with Comité Consultatif International Télégraphique et Téléphonique (CCITT), is designed to establish a data-communications protocol model for local-area networks (LANs). The purpose of the ISO model is to facilitate compatibility between the various protocols in a multivendor network, as well as to increase the software modularity of network systems via a modular, seven-layer organization. Applitek Corp.'s Universal LAN (UniLAN) implements the layers via network interface components.

The first (physical) layer refers to how user devices are connected and how data travels over a transmission medium or cable. The data-link layer defines the communications path between network nodes and the transfer of data over the shared cable. It also detects and corrects errors occurring on the physical layer. UniLAN implements these layers in the media-access unit (MAU) and in the network processor, respectively.

Layers three through seven are

implemented in network software. The third transparently routes network packets. The transport layer, implemented in the device interface, assures end-to-end data integrity and data sequencing.

The fifth, or session, layer defines procedures to make, manage and break connections between users. These connections are called sessions and include such functions as auto dialing and load sharing.

The sixth layer converts data from a sending device into a format recognizable by a receiving device. Functions include code and character-set conversions, data formatting, message

compression and encryption.

The seventh, or application, layer enables application processes to operate within the network environment, and their content depends on the application supported. The layer provides transparent network-wide resource sharing, file transfers, remote file access and database management.

The OSI model defines the logical functions of each layer, although it is not a network-design requirement. The hope is that, by adhering to these guidelines, more compatible protocols will emerge. □

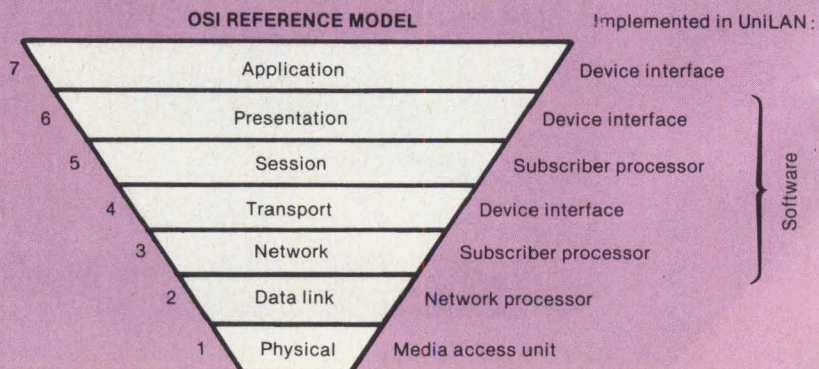



Some of our VARs' best ideas began on the backs of envelopes.

Great ideas, plus hard work, business sense and commitment to customer satisfaction. That's what it takes to be a Value Added Remarketer for IBM.

IBM is looking for business people with specialized industry experience. For companies that can successfully merge our systems with applications software. For those to whom quality is fundamental.

Put IBM to work for your customers.

To begin with, IBM wants qualified VARs to have the broadest choice of systems and software: the IBM Personal Computer, Displaywriter, Datamaster, CS-9000, 4300 systems, System/36 and Series/1 with its new enhancements.

These products carry IBM's reputation for quality. Equally important, all have access to IBM's nationwide service.

That means VARs who work with IBM have more to offer their customers. But that's only part of what IBM can offer to its VARs.

Put IBM to work for you.

IBM also provides VARs with tools to assist them in marketing to their customers and prospects.

For instance, IBM helps VARs with business shows and product literature. We help VARs create their own direct mail programs.

And IBM brings prospects with special needs together with VARs who have unique solutions. It's done with a special referencing system which supplies information about our VARs' offerings to IBM's salesforce.

IBM's Value Added Remarketer Program: Great ideas, hard work and business ability are what's required. For more information, call 1 800 IBM-VARS or send in the coupon.



Larry Humphreys
IBM Distribution Channels
P.O. Box 76477
Atlanta, GA 30358

MMS-11-83

Please send me information about qualifying as a VAR.

Name _____ Title _____

Company _____

Address _____

City _____ State _____ Zip _____

Phone _____ Product Interest _____

DEC Owners— Save Valuable CPU Processing Power with an ACC Communications Controller...

- If you have remote terminals accessing your host, but can no longer afford to surrender expensive CPU processing power for communications.
- If you have a DEC computer with local terminals that now need access to a network, but you can't justify using your CPU for protocol processing.
- If you now have local terminals on a network and you want them to access your DEC host without having to string twice as many cables and protocol boxes.

ACC offers a single solution for all of these problems. The IF-11/X.25 PLUS is based on our programmable communications controller designed specifically to work with DEC systems.

Saving CPU processing power and minimizing cabling are important to you. Call ACC. (805) 963-9431.

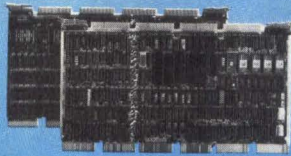

We Make Advanced Computers Communicate.

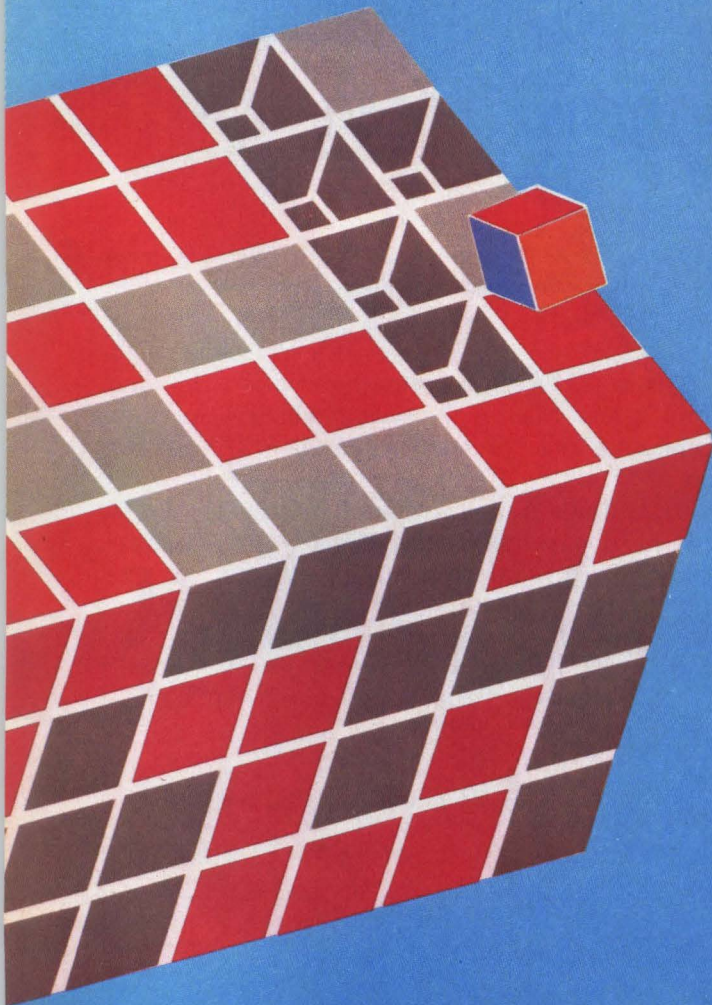
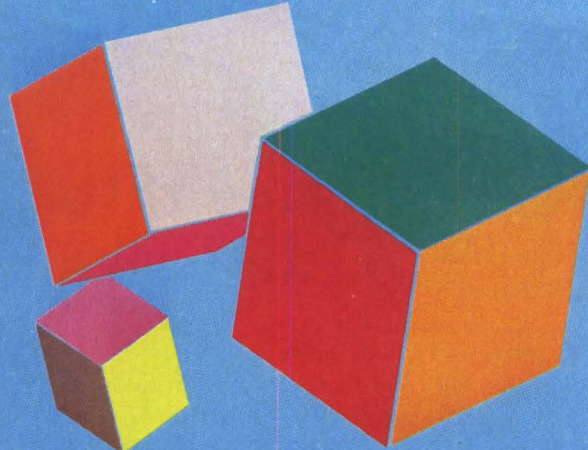
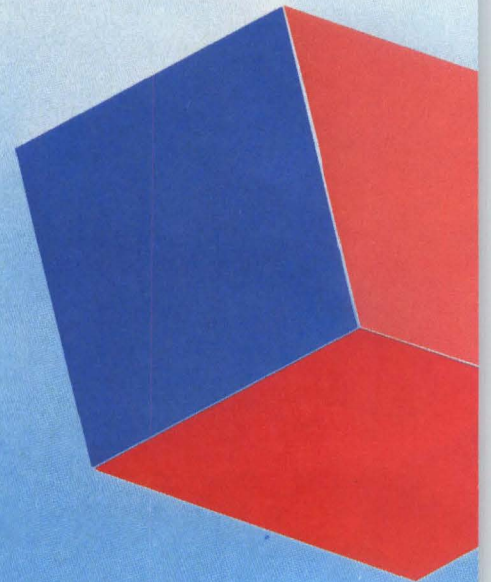

ACC

**Advanced Computer
Communications**

720 Santa Barbara Street
Santa Barbara, CA 93101
(805) 963-9431
TWX 910 334-4907

© ACC 1983 ACC is a trademark of Advanced Computer Communications
DEC is a registered trademark of Digital Equipment Corporation

CIRCLE NO. 120 ON INQUIRY CARD

Three modes of operation are available to the user: command, data and control. Command mode provides commands to connect and disconnect sessions, use a network directory, configure port parameters and send messages to other users on the network (Fig. 3). It is limited to local operations.

Data mode expedites the passing of data between devices once a session has been established. For devices that always communicate with only one destination, the network manager defines permanent sessions. Once established, the device always remains in data mode and network operation involving that device is transparent to the user.

The password-protected control mode allows remote connection and disconnection of sessions, port configuration and renaming, network control and diagnostic functions (Fig. 4). Diagnostic functions include access to an error-history log that is maintained automatically by the system and the ability to put devices into several different types of loop-back mode to pinpoint the location of problems.

Independent copies of the Software Components Group Inc.'s psOS operating system run on both the device interface and the subscriber processor. Applica-

tion software is divided into two groups of processes. One group is supported by the operating system on the subscriber processor; the other is supported by the operating system on each device interface. The layers of software adhere to the guidelines established by the Open Systems Interconnection (OSI) reference model (see "Playing by the rules," Page 246).

The RAM-based system is loaded with software code from the local floppy disk. The floppies can be down-loaded from one subscriber processor to another, facilitating updating of software. The floppy disk also holds the HELP files, port-configuration parameters, the local network directory and the field-engineering error log file.

Device-specific parameters such as baud rate, parity, flow control and other port-configuration parameters can be changed through software commands so that devices can be moved from port to port. The user can revise the software according to application requirements at any of the layers corresponding to the OSI model. The software supports asynchronous devices with data-transfer rates up to 19.2K bps. Future versions will support synchronous devices with data rates up to 56K bps. □

Ashraf M. Dahod is chairman of Applitek Corp., Wakefield, Mass.

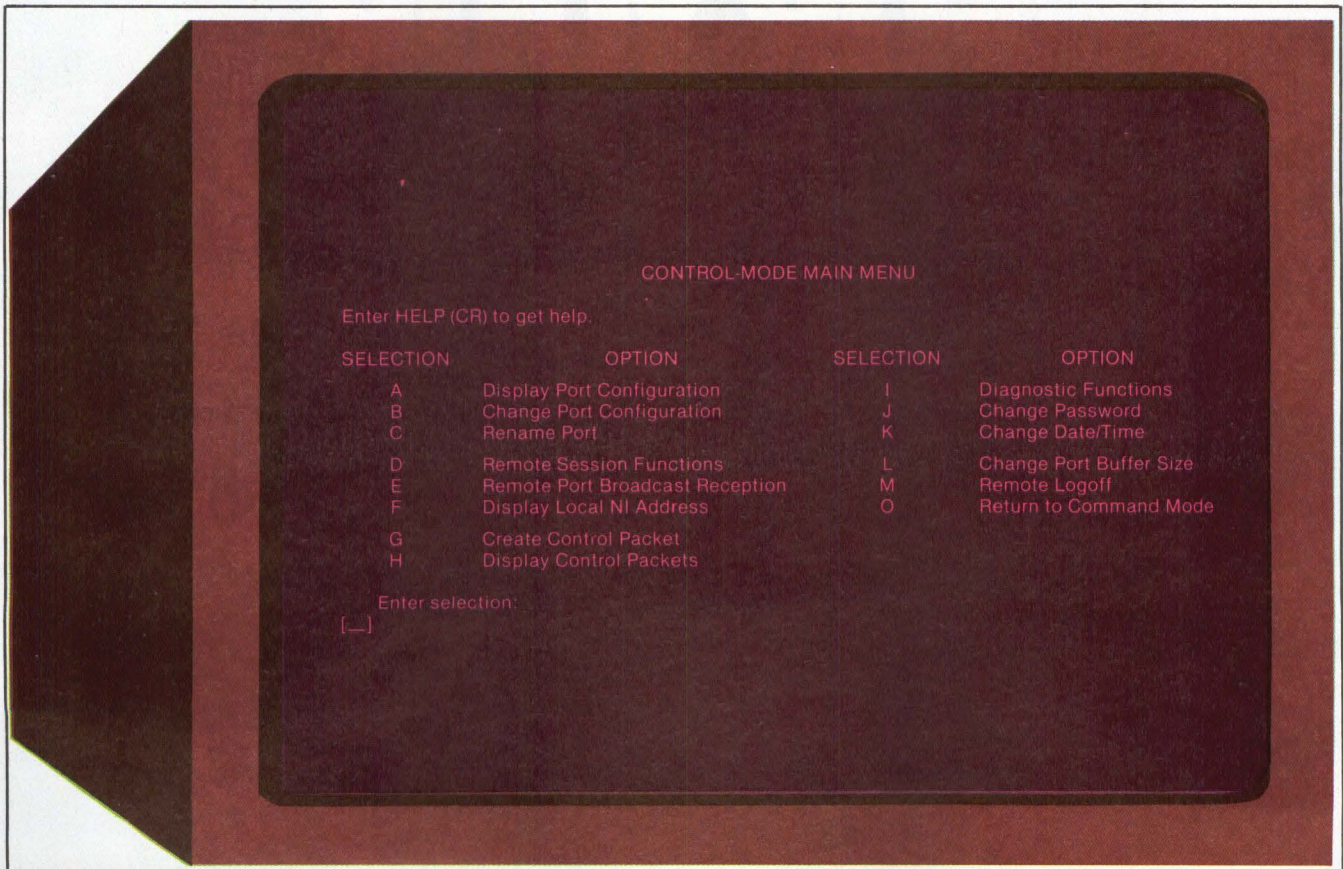

Fig. 4. The password-protected control mode main menu provides commands to connect and disconnect sessions, configure and rename ports and perform diagnostic functions.

**AT LAST,
A HIGH
PERFORMANCE,
RELATIONAL
DATA BASE SYSTEM
FOR YOUR
PRODUCTION-
ORIENTED VAX
ENVIRONMENT.**

ULTRA

You've come to expect high levels of performance from your DEC™ VAX™ hardware. And you should expect no less from your data base software.

That's why Cincom introduced the ULTRA INTERACTIVE DATA BASE SYSTEM™—a next generation relational technology that combines high performance with practical, ease of use implementation.

New Generation Architecture

The secret behind ULTRA's interactive high performance is its unique architecture. An architecture built on a solid foundation of the very latest in relational subject data base technology. In-line control and security are achieved through the ULTRA In-Line Directory while relational implementation is achieved through the unique ULTRA Logical User View and the new Data Base Management facility. Combined, these components provide interactive synergism between users, programmers and the data they wish to access.

For multiple-machine applications that can range from scientific to high volume transaction oriented business systems, ULTRA provides VAX users the control and consistency needed to build high performance, low overhead, high quality systems that can be readily used by both programmers and by the burgeoning number of end-users. ULTRA also facilitates the latest in subject data base strategies for optimum data storage, retrieval and data manipulation.

Integrated Components

The integrated components which provide this unparalleled power include:

- **The ULTRA Logical User View.** Modern, relational technology to insulate users and application programs from data structures and navigation requirements.

- **The ULTRA In-Line Directory.** Centralized control during program execution. Integration. Security.
- **The ULTRA DBMS.** High performance. Powerful. Faultless non-stop processing. Supports normalized data structures.
- **The ULTRA Intelligent Query and Reporter.** Direct end-user access. Flexible and easy to use.
- **The ULTRA Data Manipulation Language.** So powerful even the most complex processing can be handled using four commands: GET, INSERT, UPDATE, DELETE.

The Ultimate In Interactive Data Base Software For The VAX Environment

Like no other data base system available today ULTRA enables you to achieve the full potential of your VAX system. As your company evolves, ULTRA keeps right in step. And ULTRA is completely compatible with TIS™, our next generation data base system for the IBM mainframe.

So now you can implement Cincom's "IBM-DEC Connection" to link your strategic and tactical applications. In fact, the compatibility is so close, applications built on your IBM can be modified to run on VAX, or vice-versa. An ULTRA/TIS combination is the perfect IBM-DEC Connection.

For an in-depth brochure on the ultimate in interactive data base software for the VAX environment, simply contact our Marketing Services Department, 2300 Montana Ave., Cincinnati, OH 45211, or call us direct.

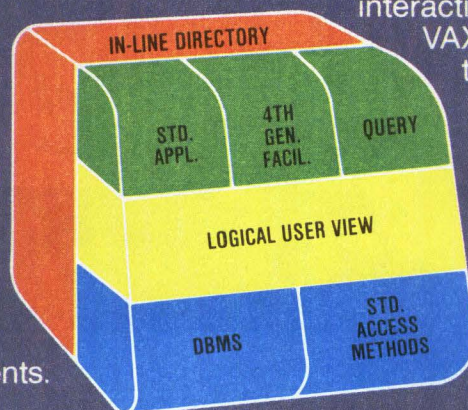

800-543-3010

(In Ohio: 513-661-6000)
(In Canada: 416-279-4220)

ULTRA, the architecture of the next generation of interactive data base technology for the VAX environment.

Cincom Systems

DON'T COMPROMI

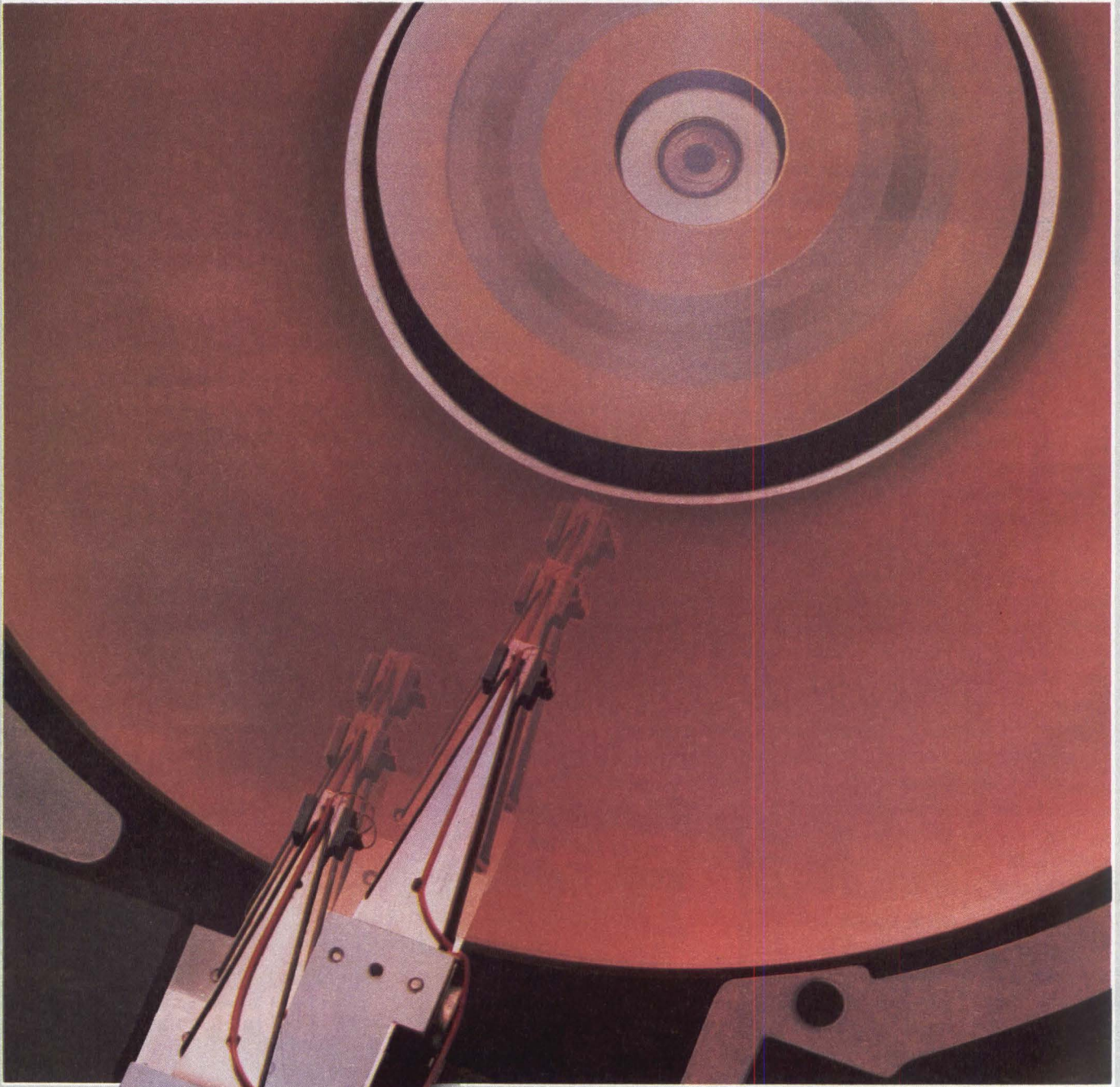

Regional Sales Offices:

Newport Beach, California, (714) 851-9964;
San Jose, California, (408) 286-7580;
Woodland Hills, California, (213) 884-2699;
St. Petersburg, Florida, (813) 577-1199;
Schaumburg, Illinois, (312) 397-3727;
Hopkinton, Massachusetts, (617) 435-6961;
Dallas, Texas, (214) 783-6711.
Authorized U.S. Distributors: Arrow Electronics,
Pioneer Electronics and Wyle Laboratories

European Sales Office:

Gassnerstrasse 5, 8000 Munich 19, West Germany, 49 89 177017, TELEX 524275 SEAG D
©1983 Seagate Technology

SE ON HALF-HIGHS

Introducing the fastest 5¼" 12MB half-high Winchester, the Seagate ST212, the rugged drive that manufacturers of portable and desktop computers have been waiting for. Now you can get a 65msec average access time drive that can withstand a 40G shock.



Don't compromise performance. Seagate's new ST212 is more than 15% faster than its nearest competitor. We also made it durable, reliable and manufacturable in volume, using improved oxide coated media and low-mass minislidder heads.

Don't compromise compatibility. Only Seagate's new ST212 single platter, four head design is completely hardware and software compatible with our ST412, the number one standard height drive. And for even greater systems performance, Seagate now offers its ST9000, a low-cost SCSI-based controller.

Don't compromise your Winchester standards. Only Seagate ships the widest range of 5¼" Winchesters in volume, and at prices OEMs can count on. In 1983, Seagate will ship more than 400,000 Winchester disc drives, all backed with a full one year warranty and our industry-leading "105% Guarantee" program.

Don't compromise. Call Seagate today. We're shipping ST212 drives in volume!



The Uncompromising ST212

Unformatted capacity (MB) 12.76

Formatted capacity (MB) 10

Average access time (ms) 65

"Turning the tide in disc technology"

Seagate 

920 Disc Drive, Scotts Valley, CA 95066, (408) 438-6550, TELEX 176455SEAGATESCVL
See us at COMDEX Booth #4324

THE FIRST MOBILE COMPUTER.

THE COMPLETE COMPUTER FOR THE MOBILE PROFESSIONAL.

Professionals on the move in today's productivity-paced business environment have to run a little faster just to keep up.

They can easily spend half their time in airports, taxis, lobbies and hotels unable to do the work they'd like to get done.

But we have a solution.

Give them the powerful 9 pound, 16-bit computer that works when and where they do.

Give them an advanced battery-powered printer that attaches securely on the computer.

Give them an interactive human interface and operating environment that takes only 15-30 minutes to learn.

And unique field-oriented software that comes in rugged plug-in capsules.

In short, give them the Gavilan™ mobile computer.

PORTABLE TURNED PRACTICAL.

Never has there been a complete business computer system as sophisticated, yet as lightweight, as the Gavilan.

Self-contained, rechargeable 8-hour batteries free the user from external power constraints.

The 8 line X 80 character screen eliminates the need for an external monitor, although you can add one if you wish.

The full-size typewriter keyboard makes data entry as convenient as it is in desktop systems.

A built-in 3½" microfloppy disk drive and modem provide the capabilities of data handling and transmission where they never before existed.

And a 50 character per second printer gives the mobile professional in the field the immediacy of hard copy text, forms, charts, spreadsheets and graphics.

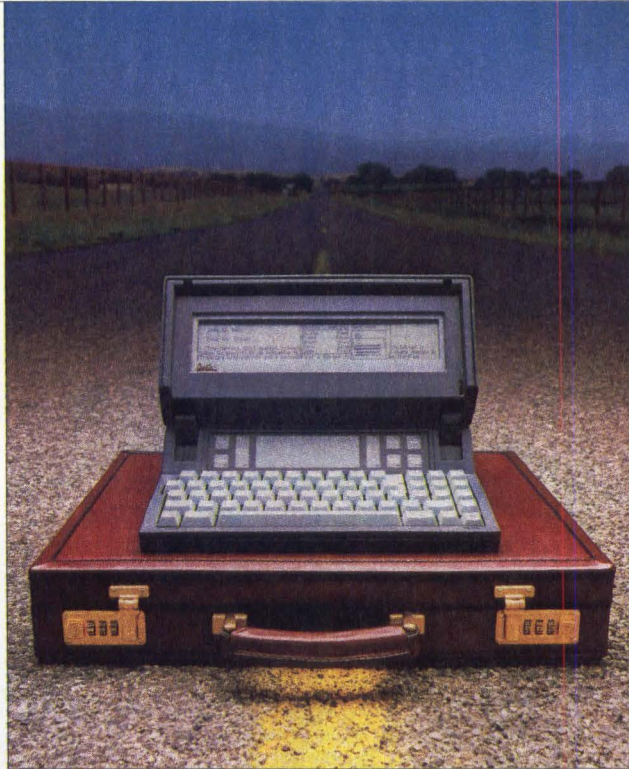

All in a compact 14 pound mobile office.

WE BUILT A MORE MOBILE MOUSE.

The success of any computer depends in part on the "friendliness" and accessibility of the user interface.

Especially in the field.

A standard mouse interface is fine for the expanse of a desktop, but not for work on the move.

So with the Gavilan, we incorporated a built-in touch panel: the first fully integrated computer mouse.

It's a pressure-sensitive pad just above the keyboard. Finger movements across the touch panel control the on-screen movements of a cursor.

But like a mouse, the Gavilan touch panel actually executes virtually all of the user commands, saving the keyboard for typing only.

Through the touch panel,

users store and retrieve data. Cut and paste. Move documents. Scroll through pages of information. Zoom out for a complete look at the format of a document. Or even ask the computer what just happened and what to do next. With one finger.

SOFTWARE IN A CAPSULE.

The intuitive ease of talking to the computer through the touch panel is made possible by the unique Gavilan operating environment and software packages.

The applications packages come in durable capsules called CapsuleWare™. They plug directly into the body of the computer, adding no additional volume. The operating software, (GO System™) then lets each of the applications communicate with each other through a common interface and a sharing of data.

The result is a completely integrated information environment that lets the user combine spreadsheets, graphics and word processing text together.

All in the same uninterrupted user mode.

OUTWARD MOBILITY FOR USERS, UPWARD MOBILITY FOR OEMs.

The Gavilan mobile computer and its CapsuleWare programs are creating vertical market demands—both in MS/DOS and the Gavilan operating environment—for software packages completely unrealized one short year ago.

That means new opportunities in applications development far beyond the typical office-bound programs. From air and sea navigation to banking services. Journalism to field auditing. Anthropology to insurance.

And that means you've got the chance to be first in your chosen field.

A position we strongly advocate.

Gavilan Computer Corp.
P.O. Box 5004
Campbell, CA USA 95008
(408) 379-8000
Telex 4991278 GVLN US

Gavilan



Gavilan, CapsuleWare and GO System are trademarks of Gavilan Computer Corporation. MS/DOS is a trademark of Microsoft Corporation.

Tailoring UNIX for the supermicro business environment

PAUL REILLY,
Momentum Computer Systems International

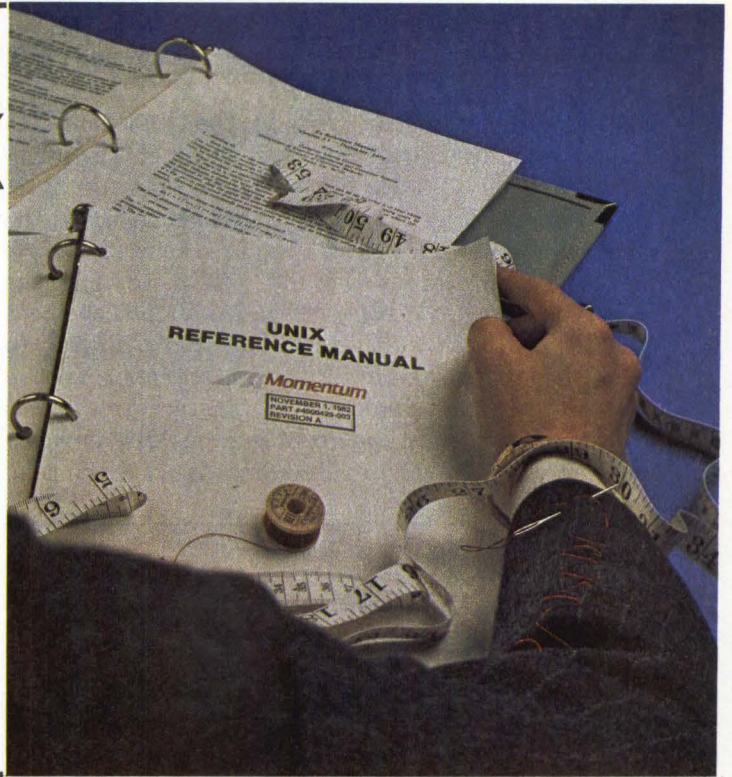

MC68000-based micro incorporates Unify DBMS and enhances UNIX's data communications and user interface

UNIX is more than 10 years old and showing its age. Consequently, several microcomputer manufacturers have introduced enhanced systems that retain UNIX's strongest features while bringing it more into line with higher performance hardware developed since UNIX's inception. One such manufacturer is Momentum Computer Systems International, which has adopted the Unify database manager to overcome UNIX's slow access to large databases. Momentum has also redesigned portions of the UNIX kernel, tuning it to the architecture of the MC68000 used in the company's 32/E microcomputer.

Improving the UNIX file system

The minicomputer systems of the early 1970s had relatively little disk storage. This led to the development of UNIX's complex and awkward file system, which was designed to use every available block of disk space by scattering file blocks throughout the disk with little regard to ease and speed of access (Fig. 1). Reading a file sequentially as UNIX does requires many disk head movements because blocks of the same file can be located on different tracks or cylinders.

Momentum alleviated this problem by tuning file-

system parameters so that related file blocks are usually located on the same or adjacent cylinders (Fig. 2). Although the individual blocks can still be scattered, they are organized to minimize disk head movement.

Another disadvantage of a scattered file structure is that a mechanism is needed to keep track of where each file block is on the disk. The mechanism UNIX uses is based on the text-processing environment for which it was developed. In this environment, numerous small text files, each only a few thousand bytes, must be accessed sequentially and updated frequently. To accomplish this, UNIX uses the *i-node* indexing scheme to address most of the blocks in a large file (Fig. 3). The *i-node* contains 13 pointers to physical disk blocks, the first 10 of which point directly to the first 10 blocks of a file. If a block is 512 bytes, as is usually the case in a UNIX system, the first 5,120 bytes of the file can be directly addressed using the *i-node*. Blocks 11 through 138 are indirectly addressed via a disk block of 128 pointers pointed to by the 11th entry of the *i-node*. Thereafter, the process becomes progressively more complex. The 12th word of the *i-node* points to a block containing 128 pointers to 128 additional blocks of

pointers. Finally, the 13th entry of the i-node points to the start of a three-level index structure. This arrangement expands a UNIX file to more than 1G byte. However, the price a user pays for this design is the large number of disk accesses required to read a single file block. The larger the file, the more overhead required. Added to this overhead is data movement from the disk to a UNIX system buffer and eventually to the requesting program. Although not important in text processing, in which most files are small, this overhead is critically important in a business environment, in which megabyte-sized databases are the rule.

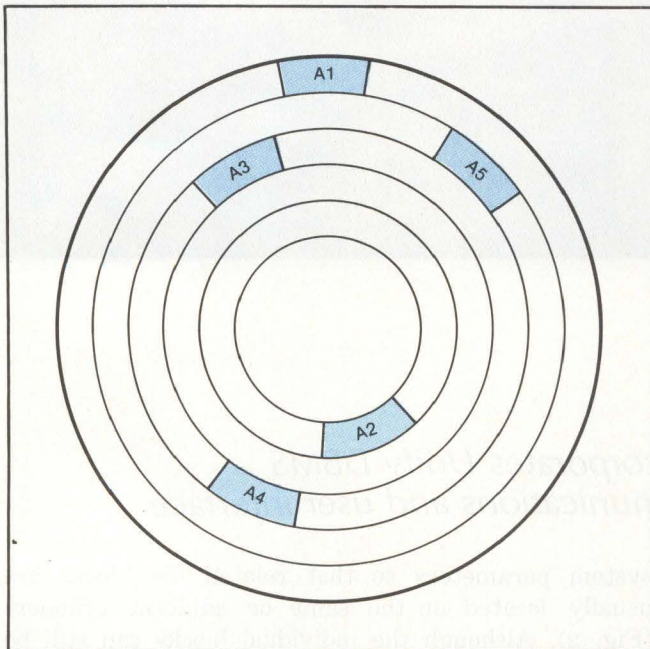

Fig. 1. UNIX scatters file blocks throughout the disk, allowing every available space to be used but at the expense of speed and ease of access. Because related file blocks can be located on widely separated tracks or cylinders, reading a file sequentially requires much head movement.

Nothing less than a complete rewrite of the UNIX file system can solve the disk-access problem. However, its effects can be minimized. Momentum has designed the disk subsystem driver so that a physical disk can be subdivided into several logical disks, permitting an application program to use a file system other than UNIX on a partition of the physical disk (Fig. 4). An example is Unify, the database-management system selected by Momentum, whose "raw mode" file system is superior to UNIX's file system for large database applications (Table 1). Unify dispenses with the multiple disk accesses of i-node addressing and uses contiguous physical blocks within a logical partition. It gains access to data by specifying a block offset from the start of the logical partition. Momentum's disk

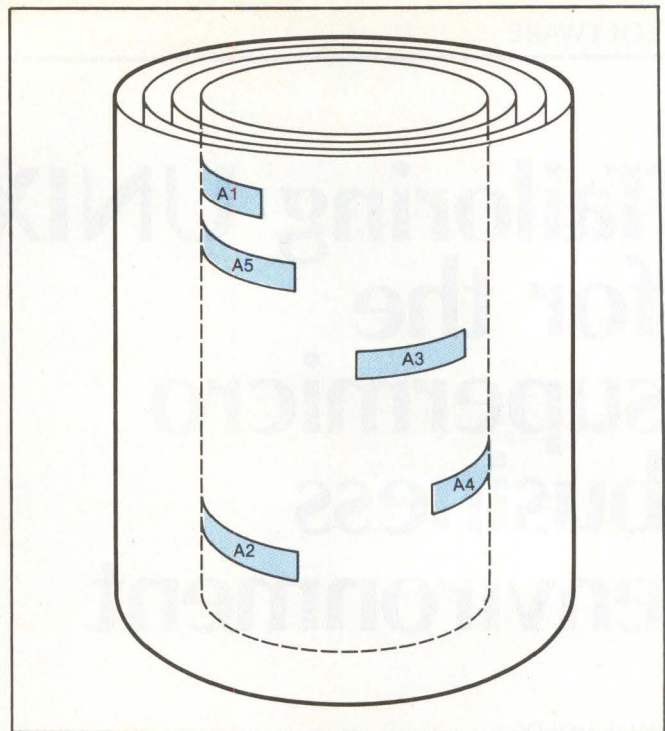

Fig. 2. To minimize the excessive disk head movement caused by UNIX's scattered file placement, Momentum groups blocks of the same file on the same or adjacent cylinders of a multiplatter disk. In the diagram, the five individual file blocks, although scattered, are all on the same cylinder.

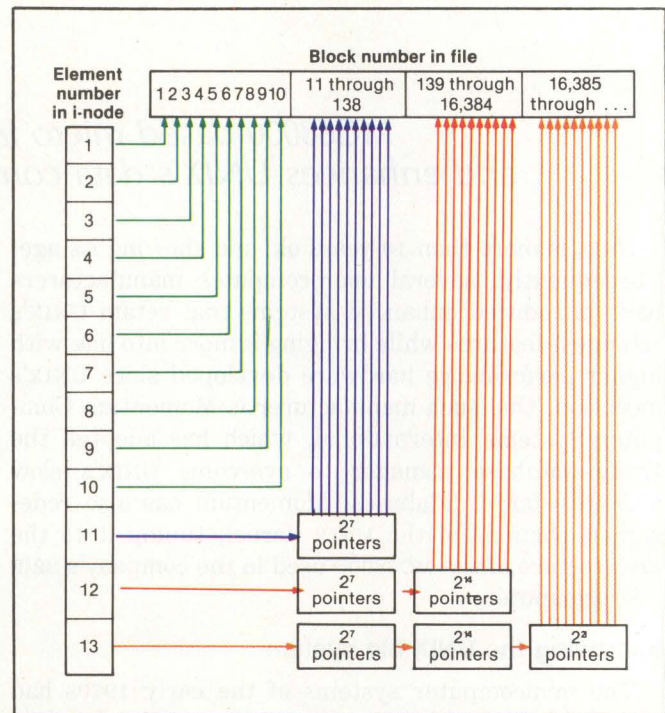
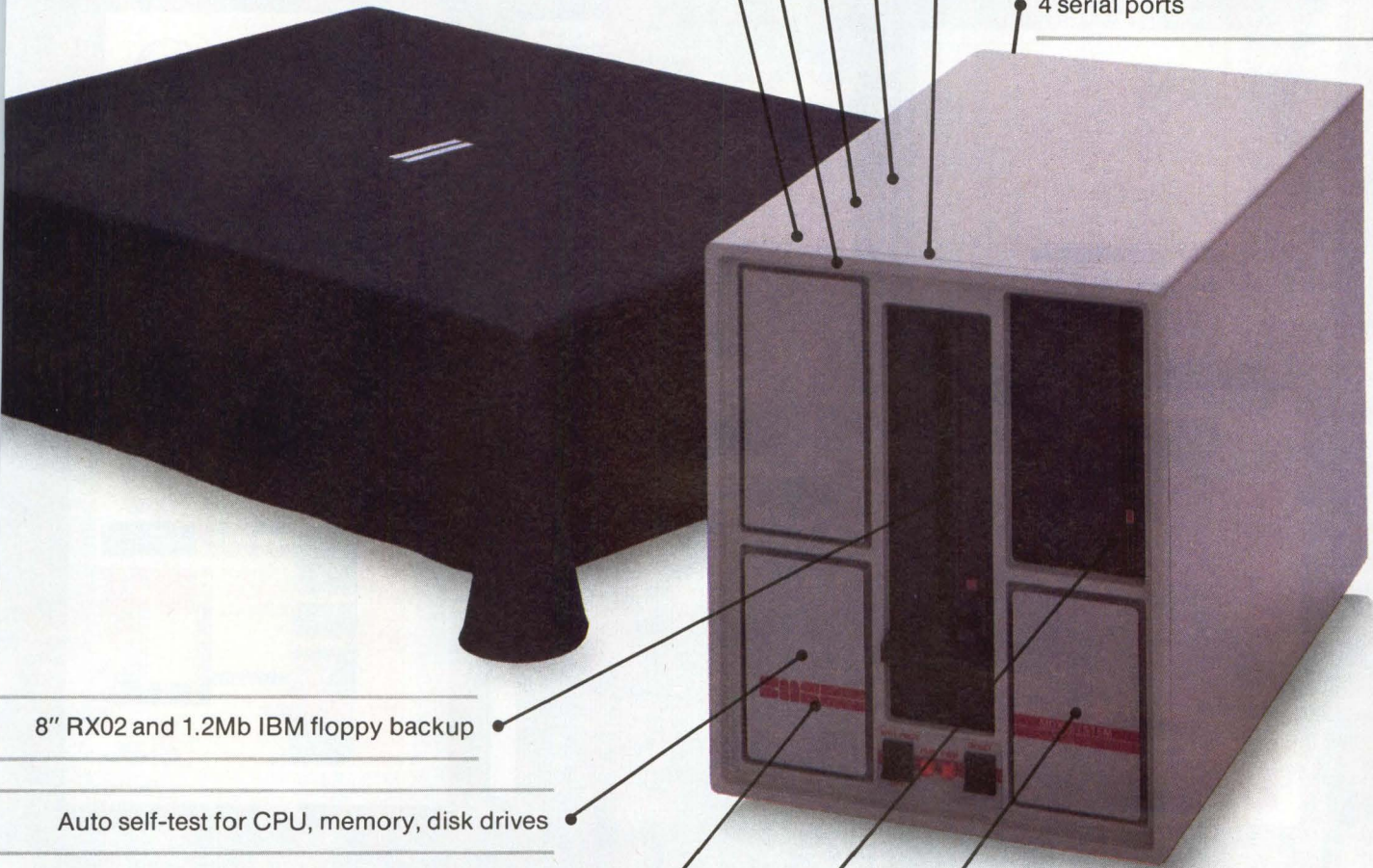

Fig. 3. UNIX i-nodes permit direct access to the first 10 blocks or approximately 5K bytes of a file (green). The i-nodes also give the addresses of three overflow pointer blocks that point—through increasing levels of indirection—to the remainder of a file. One level of indirection (purple) is required for files between 5K and 70K bytes, two levels (red) for files between 70K and 8M bytes and three levels (orange) for larger files. The i-node technique works well on small files but becomes progressively more cumbersome on files requiring indirect addressing. For example, a 110K-byte file, which needs two levels of indirection, involves three disk accesses to store or retrieve data.

Available now!
And SMS is not
afraid to show it

SMS' MDX-11
Micro Winchester
System in a Micro Package



Compact 9.5"W x 11.2"H x 17"D table top package

256Kb main memory (4Mb addressability)

Expansion space for 4 dual LSI-11 boards

PDP-11* architecture compatible with DEC*
RT-11, RSX-11M, Unix** and TSX+*** software

LSI-11/23 processor

4 serial ports

8" RX02 and 1.2Mb IBM floppy backup

Auto self-test for CPU, memory, disk drives

Easy access to LED display of system faults

10.6Mb or 15.9Mb 5/4" Winchester package

Advanced disk controller with ECC, flaw management, bootstrap,
error retry, and direct non-interleave data transfer

AVAILABLE WITHOUT CPU and memory for volume requirements

SMS
Scientific Micro
Systems, Inc.

777 E. Middlefield Road
Mountain View, California 94043
(415) 964-5700

AUTHORIZED SMS DISTRIBUTOR FOR DEC
Q-BUS PRODUCTS: FIRST COMPUTER
CORPORATION (312) 920-1050

SMS SALES OFFICES:

Seattle, Washington (206) 883-8303

Boston, MA (617) 246-2540; Atlanta, Georgia

(404) 296-2029; Morton Grove, Illinois (312)

966-2711; Yorba Linda, California (714) 993-3768.

* Trademark of digital Equipment Corporation. **Trademark of Western Electric.

***Trademark of S & H Computer

CIRCLE NO. 124 ON INQUIRY CARD

Not only will CalComp's digitizing tablet integrate with your equipment, it will look like it, too.

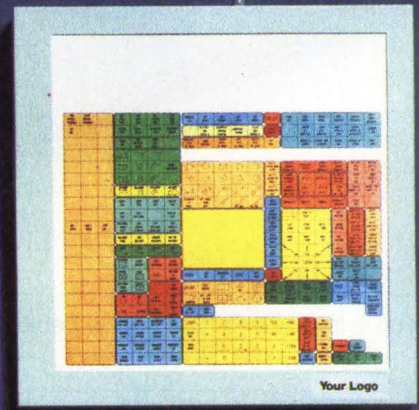
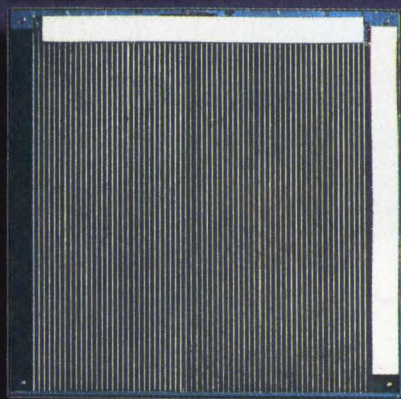
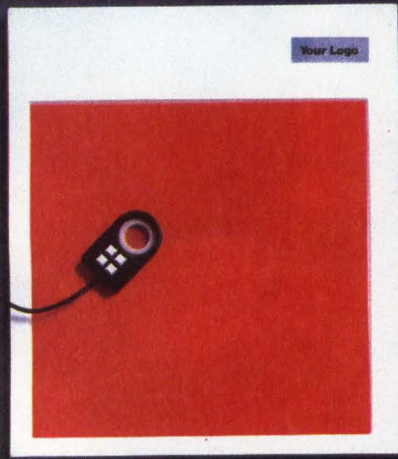
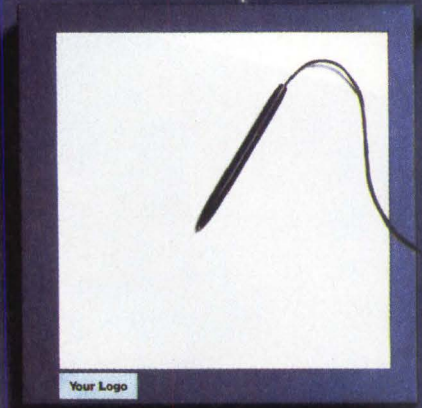
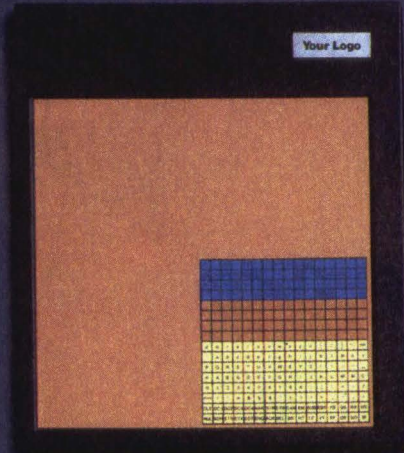
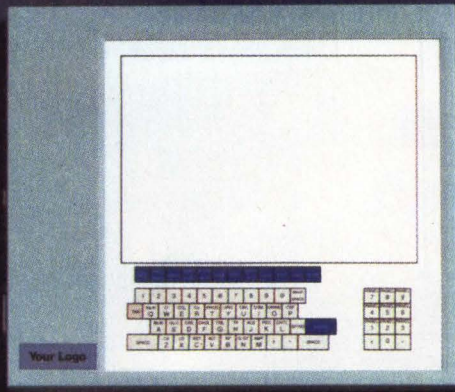

While other tablets give you just one color, CalComp gives you a choice.

With CalComp's 2000 Series Tablet you get all the colors and textures you need to match it perfectly with your equipment. Plus, you'll have a choice of a metal or plastic case or no case at all. So instead of standing out like a sore thumb, the 2000 Series will fit right in.

It fits in other ways, too. The 2000 Series is plug-compatible with

competitive models. And with its flexible output format it will easily integrate with all your equipment.

The 2000 Series also offers you a long list of features, including self-contained electronics, mouse and joy stick emulation and the most reliable pen on the market. It all adds up to the best price and performance investment you can make.

So if the other digitizer tablets on the market have been looking drab to you, take a look at CalComp's

2000 Series. It stands out—even when it's fitting in.

For complete information, call or write: CalComp, 2411 West La Palma Avenue, P.O. Box 3250, Anaheim, CA 92803. In continental U.S., except California, call (800) 556-1234, ext. 156. In California call (800) 441-2345, ext. 156.

CALCOMP

A Sanders Graphics Company



SANDERS

CIRCLE NO. 125 ON INQUIRY CARD

driver converts these logical addresses into physical sectors on the disk and transfers data to and from user memory without system buffering.

	Real time (min. : sec.)	Machine time (min. : sec.)	Records per sec.
System unloaded:			
Unify DBMS using "raw mode" file accessing	3:15	2:34.9	2.84
DBMS using UNIX file system	4:47	4:18.9	1.93
System loaded:			
Unify DBMS using "raw mode" file accessing	9:30	2:41.3	0.97
DBMS using UNIX file system	12:55	4.39	0.71

Table 1. In file-access timing comparisons, the Unify DBMS using raw-mode file access was benchmarked against a comparable DBMS using the standard UNIX file system. In a loaded (DBMS and other file-intensive tasks) and unloaded (DBMS-only) environment, 553 records were added to a 10M-byte database. In both tests, the raw-mode technique used about 40 percent less machine time.

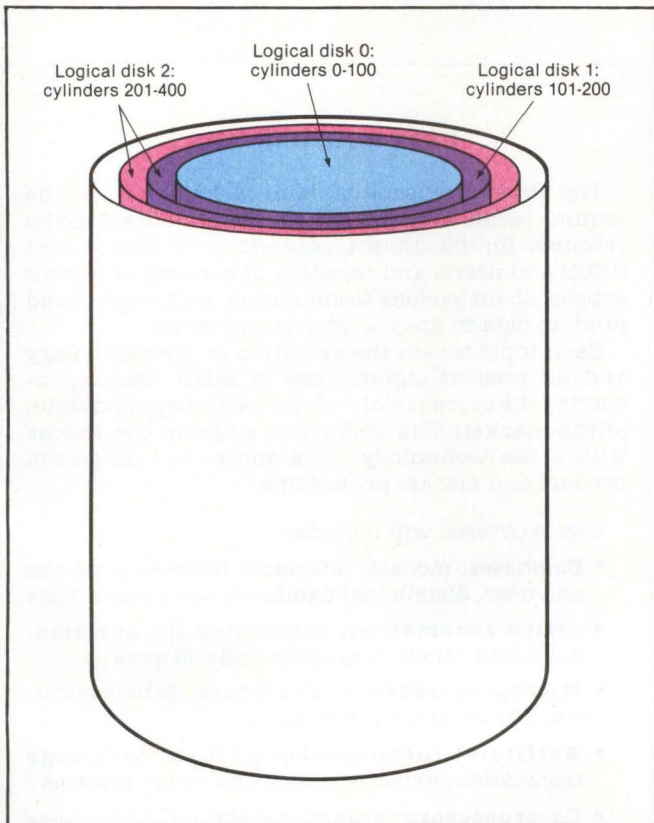

Fig. 4. Subdividing a physical disk into several logical disks offers a choice of file-access methods. For example, logical disks 0 and 1 might contain standard UNIX files, while logical disk 2 might hold "raw-mode" files used by the Unify database-management system (DBMS).

Another limitation of the UNIX file system is that it is designed for sequential access, which is inflexible for most business applications. Momentum allows application programs random access to file blocks via Unify instead of UNIX. This provides a double benefit: Unify's random access capabilities can be incorporated into high-level languages such as COBOL, and application programmers can employ the facilities of Unify to implement complex tasks.

Correcting UNIX's teleprinter, user interfaces

During the early 1970s, when UNIX was originally implemented, the ASR-33 Teletype was the only reasonably priced interface to a minicomputer system. It was inexpensive, easily maintained and widely available.

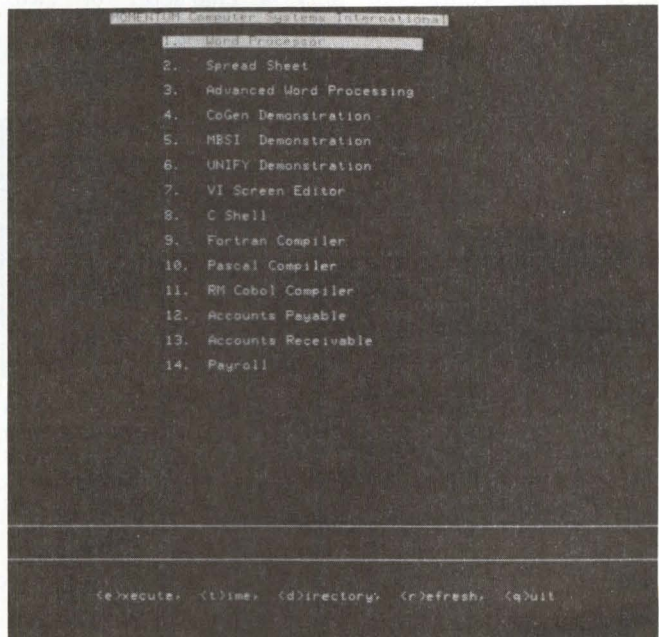

Fig. 5. Momentum's "shell" menu simplifies the UNIX interface for business users. Menu items can be varied according to user needs. The display shown is invoked automatically whenever a user logs in or exits an application.

But it also was slow—10 characters per second (cps)—and required approximately 10 pounds of pressure to depress one of its keys. Because the ASR-33 ran at a slow 110 baud, little attempt was made to streamline UNIX's terminal interface. The aggregate throughput for terminals on a typical UNIX system today is barely 1,200 baud, fast enough for 10 ASR-33 terminals but only one-eighth the rate of a modern 9,600-baud CRT terminal. To provide a communications rate consistent with today's business system requirements, Momentum has rewritten major portions of the UNIX terminal driver and handling code. The result is a 3,000 percent increase in aggregate terminal throughput, the equivalent of four 9,600-baud terminals running continuously at maximum speed. Moreover, because CRT terminals rarely run at maximum rates for more than a few moments at a time, Momentum's

terminal driver can serve as many as 16 users per system with no visible degradation in response time.

Another consequence of using the ASR-33 is UNIX's terse and arcane command syntax. Because the ASR-33 was very slow and required heavy key pressure to depress its mechanical linkages, early UNIX users soon learned to print only what was necessary and to type the absolute minimum number of keystrokes. Thus, user commands were usually only two or three characters, and they did not print status information unless an error occurred. Even error messages were brief, some containing only a character or two. Although this is fine for a knowledgeable user, a neophyte is left in the dark.

Model	Benchmark time (sec.)	Price (\$)
Momentum 32/E	106	34,000
Perkin-Elmer PE 3210	93	75,000
DEC VAX-11/750	85	115,000
DEC VAX-11/780	83	196,000

Table 2. In a comparison of four systems, each system shown performed three tasks in UNIX Version 7: sorting a small file, sending a file to two terminals and reading an entire logical disk. Benchmark times are total real time for all tasks. Package includes eight I/O ports, a disk drive, a tape drive, a console and an operating system. (Source: Momentum Computer Systems International)

For example, the command `ls -R|sort|uniq -c|pr -3|tee cop1|pr` lists recursively the entire file-system directory, sorts it alphabetically, removes—but keeps count of—redundant entries, displays the list in three-column format, writes a copy of it to a file named `cop1` and prints it on the line printer—an impressive array of tasks relative to the number of characters in the command line. However, the command syntax is far removed from English and certainly not user friendly. All keystrokes, including blank spaces, must appear exactly as shown or the command will not function.

Fortunately, UNIX is unique among operating systems in that its user interface is not part of the system kernel, but merely an application program. The interface, or shell, is easily replaced. Momentum has designed a menu shell for business computer users looking for a friendly environment (Fig. 5). Menu selection can easily be varied according to a user's needs and is automatically called by simply logging in. All a user needs to do is type in the account's name and password and select the program from the menu.

Fine-tuning for the MC68000

UNIX was the first practical portable operating system, but it often suffers in performance when ported to a different machine. For example, several benchmarks show that UNIX Version 7 is faster on the PDP-11/70 than any of the VAX-11 systems. The PDP-11/70 is certainly not faster than the VAX-11/780, but UNIX is better tuned to the PDP-11/70, making it difficult to run UNIX efficiently on a different set of hardware without much effort. For example, Momentum has increased the number of register variables in the most frequently used UNIX kernel routines from the PDP-11's three to the MC68000's seven, increasing throughput on its MC68000-based systems by 10 to 20 percent. Adding hardware such as linear voice-coil Winchester and smart serial I/O boards can further increase performance. A recent benchmark (Table 2) shows that the Momentum 32/E microcomputer with linear voice-coil Winchester produces 80 percent of the throughput at less than 20 percent of the price of the VAX-11/780. □

Paul Reilly is technical services manager with Momentum Computer Systems International, Sunnyvale, Calif.

NEXT MONTH IN MMS

The December issue of *Mini-Micro Systems*, the annual technology review, is MMS's encyclopedic resource for its unique readership of value-added OEMs and users, and resellers. It consists of feature articles about various technologies, with market and product data in graphs, charts and tables.

Each topic covers the evolution of the technology and its present significance to MMS readers, including the current state-of-the-technology and state-of-the-market. The issue will address the trends within the technology, plus short- and long-term product and market projections.

Topics covered will include:

- **Databases:** models, interfaces between program and user, distributed databases and applications
- **Office automation:** integrated OA systems, dedicated function systems and software
- **Microprocessors:** architecture, fabrication, simulation and packaging
- **Artificial intelligence:** natural language translation, expert systems and vision systems
- **Co-processors:** communications, local area networks and floating point arithmetic

ONLY ONE SUPERMICRO KNOWS 13 LANGUAGES.

The keys to your success, now and for the future, are flexible systems with a breadth of languages that protect your software investments. These languages save you time, minimize effort, and give you a powerful tool, particularly useful for the many end users looking at updating their hardware.

Considering all this; consider the Pixel 80. Not only do we have a catalog of programming languages and developmental aids that is unmatched in the 68000-Unix™ world, we have a wide range of data base management systems, word processors, spread sheets, and ready-made applications packages.

HARDWARE POWER TO MATCH SOFTWARE POWER

A few hard facts:

1. The Pixel 80 has a multi-processor architecture. A 10 MHz Motorola 68000 runs the operating system and user programs. It can fetch memory as fast as a 68000 can go.
2. With up to 6 million bytes of no-wait-state RAM combined with hardware memory mapping, the Pixel 80 makes possible applications that could never before be run on a microcomputer.
3. Winchester and floppy disk drives combined with cartridge tape back-up and software file management techniques allow for flexible growth and expansion.

ALL THIS AND IT'S EASY TO USE.

Our Unix operating system includes Berkeley, PWB, and Pixel enhancements. It's powerful, portable and very, very friendly.



LOOK TO THE FUTURE.

Something to consider: while the Pixel 80 almost matches the VAX 780 in raw computing power, it is less than half its price. Yet, as attractive as our price/power ratio is, we maintain that the ultimate reasons for considering us are our unmatched range of languages and great software support. Because, when the technological fall-out has fallen out, the ones still standing will be the ones who know the most, and speak the best. With Pixel 80 you've already got a good jump on the future.

For more information, write Pixel Computer, Inc., 260 Fordham Road, Wilmington, MA 01887, or call (617) 657-8720.

PIXEL COMPUTER

LEVEL II COBOL is a trademark of Micro Focus, Inc.
RM/COBOL is a trademark of Ryan McFarland Corporation.
SIBOL is a trademark of Software Ireland, Ltd.
TeleSoft Ada is a trademark of TeleSoft.
UNIX is a trademark and service mark of Bell Laboratories.
TOMBASIC™ is a trademark of TOM Software.

KNOWLEDGE IS POWER.



*StacPac, HyperDiagnostics, Rapid Module Exchange and HyperService are trademarks of Data Systems Design, Inc.
*DEC is a registered trademark of Digital Equipment Corporation. *Multibus is a registered trademark of Intel Corporation.

DSD STACKS THE DEC. AND THE MULTIBUS, TOO.

Presenting StacPac™ systems and modules.

This is a brand new deal for systems integrators.

StacPac systems and modules. Modular storage and backplane units that stand alone or stack together to form the basis of a small but powerful tabletop computer.

They're available in either DEC®- or Multibus®-compatible versions. And there are lots of advantages to both.

On the DEC side, you can put a StacPac system in places a rack-mount just doesn't fit.

On the Multibus side, you can use our StacPac system to deliver serious minicomputer performance with microcomputer economy.

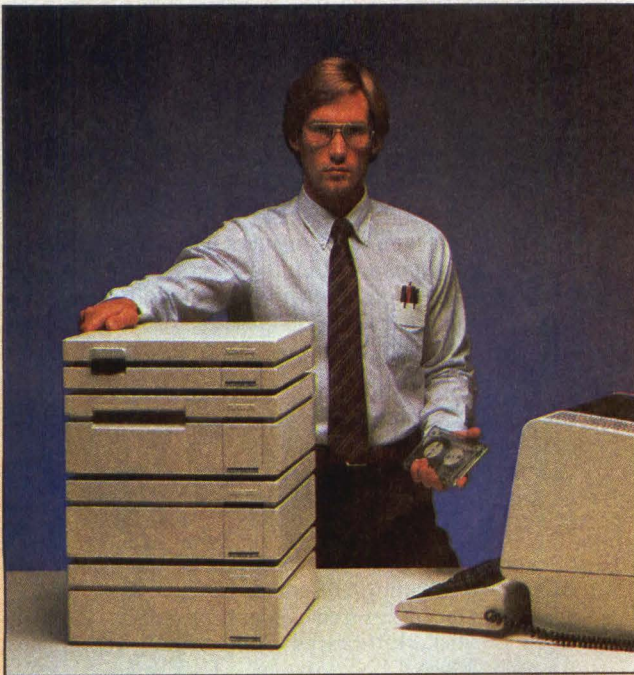

CIRCLE NO. 127 ON INQUIRY CARD

Either way you get greater flexibility to configure just the right system. And the easy upgradability to expand it whenever you like.

But perhaps one of the most important advantages is that you can protect your software investment—and your customers'—because inside, you're still selling the same system. You'd just never know it to look at it.

Which brings up another point.

Underneath that slick, compact exterior is the very latest in storage technology. 8" slimline floppy drives. High capacity, highly reliable 8" Winchester. Compact 1/4" cartridge tape drives. And the best high performance controllers in the business. (Packaged systems are also available without controllers at your option.)

And if you're thinking about 5 1/4" storage, there's our 5 1/4" Winchester/floppy module. (Available in the Spring of 1983.)

Configuring an elegant system solution is a simple matter of picking out the storage option you want and adding your own CPU boards, I/O and memory to our uncommonly accommodating backplane units.

Naturally, we back it all up with HyperDiagnostics™, Rapid Module Exchange™ and HyperService™. Some of the most economical and intelligent service features ever devised.

And you can have more information about StacPac modules just by writing for our brochure.

But you just watch. You start marketing your systems in our StacPac modules and your competition will say you have an unfair advantage.

And you know something? They'll be right.

Corporate Headquarters: 2241 Lundy Avenue, San Jose, CA 95131. Eastern Region Sales and Service: Norwood, MA, (617) 769-7620. Central Region Sales and Service: Dallas, TX, (214) 980-4884. Western Region Sales: Santa Clara, CA, (408) 727-3163.

DATA SYSTEMS DESIGN

INTERNATIONAL SALES: Australia 03/544 3444; Belgium and Luxembourg 02/7209038; Canada 416/625 1907; Denmark 02/63 22 33; Finland 90/88 50 11; France 03/411 5454; Hong Kong and Peoples Republic of China 03/696231; Israel 52-52444; Italy 02/4047648; Japan, Osaka 06/323 1707, Tokyo 03/345 1411; Netherlands 02977-22456; New Zealand 04/693 008; Norway 02/78 94 60; Singapore, Malaysia, and Indonesia 2241077; Spain 01/433 2412; Sweden 08/38 03 70; Switzerland 01/741 41 11; United Kingdom 7073/34774; West Germany and Austria 089/1204-0; Yugoslavia 61/263 261



"See the StacPac™ storage and backplane modules and RAMTRAC™ line of Multibus® supermicro controller boards at booth 4333."

HALF HIGH

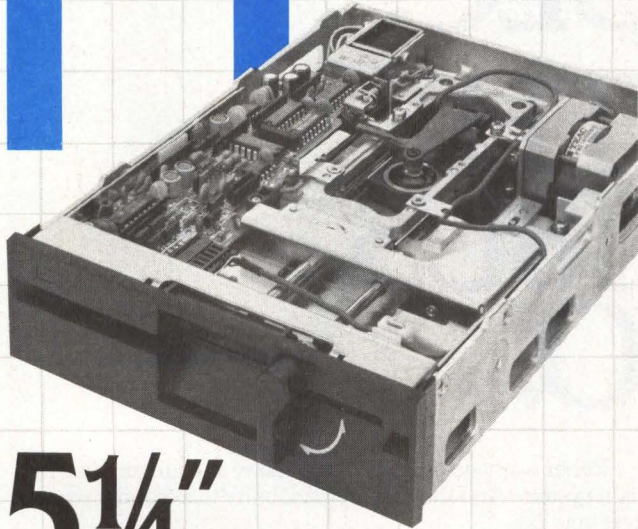

5 1/4" Floppy Disk Drives TEAC FD-55 Series

AT 1 5/8" HIGH, TEAC FD-55 SERIES 5 1/4" FLOPPY DISK drives use half the space and run cool at half the power of conventional drives. High-reliability, low-noise brushless DC motors provide an MTBF of over 10,000 hours, backed by a one-year parts and labor warranty.

FD-55A	FD-55B	FD-55E	FD-55F
• 48tpi	• 48tpi	• 96tpi	• 96tpi
• 40 track	• 40 track	• 80 track	• 80 track
• 250KB	• 500KB	• 500KB	• 1MB
• single side	• double side	• single side	• double side

Power Requirements:

DC +12V $\pm 5\%$ 0.3A typical, 0.7A max.
DC + 5V $\pm 5\%$ 0.5A typical, 0.7A max.

Phone, write or wire TEAC Corporation of America for complete technical data, price and delivery.

TEAC Corporation of America
Industrial Products Division
7733 Telegraph Road
Montebello, CA 90640
213/726-0303

© 1982 TEAC Corp.
MP82501M

CIRCLE NO. 128 ON INQUIRY CARD

NOVEMBER

- 1-3 Federal Office Automation Conference**, Washington, sponsored by the National Council for Education on Information Strategies. Contact: National Council for Education on Information Strategies, P.O. Box N, Wayland, Mass. 01778, (617) 358-5356 or (800) 343-6944.
- 1-3 INTECH '83 Integrated Office Technology Conference and Exposition**, Chicago. Contact: Jacqueline Voigt, National Trade Productions Inc., 9418 Annapolis Rd., Lanham, Md. 20706, (301) 459-8383 or (800) 638-8510.
- 2-4 Edmonton Computer & Office Automation Show**, Edmonton, Canada, sponsored by Industrial Trade Shows of Canada. Contact: Industrial Trade Shows of Canada, 20 Butterick Rd., Toronto, Ontario M8W 3Z8, (416) 252-7791.
- 7-9 Satellite Communications Symposium**, Atlanta, sponsored by Scientific-Atlanta Inc. Contact: Betsy Crawley, Symposium Coordinator, 3845 Pleasantdale Rd., Atlanta, Ga. 30340, (404) 449-2274.
- 8-10 CAM-I's 12th Annual Meeting and Technical Conference**, Dallas, sponsored by Computer Aided Manufacturing-International Inc. Contact: Rhonda Gerganess, Manager, Conference Services, or John R. Forton, Marketing Manager, CAM-I Conference Services, 611 Ryan Plaza Dr., Suite 1107, Arlington, Texas 76011, (817) 860-1654.
- 8-10 The Hammer/Seybold Executive Forum: "Directions in Office and Professional Computing,"** New York, sponsored by Hammer and Co. Inc. Contact: Cheryl McManamy, Seybold Publications Inc., 44 Bromfield St., Suite 801, Boston, Mass. 02108, (617) 542-2261.
- 8-10 Third Annual Software Expo**, London. Contact: SOFTWARE/Expo, 22 W. Adams St., Suite 400, Chicago, Ill. 60606, (312) 263-3131.
- 14-16 "Applied Interactive Computer Graphics" Course**, Los Angeles, sponsored by the Continuing Education Institute and Computer Graphics Consultants. Contact: Continuing Education Institute, 10889 Wilshire Blvd., Suite 1000, Los Angeles, Calif. 90024, (213) 824-9545.
- 14-17 Canadian Computer Show & Conference**, Toronto, sponsored by Industrial Trade Shows of Canada. Contact: Industrial Trade Shows of Canada, 20 Butterick Rd., Toronto, Ontario M8W 3Z8, (416) 252-7791.
- 15-18 "Practical Structured Techniques for Software Design & Coding" Seminar**, Palo Alto, Calif., sponsored by Integrated Computer Systems. Contact: Ruth Dordick, Integrated Computer Systems, 6305 Arizona Place, Los Angeles, Calif. 90045, (213) 450-2060. Also to be held on Dec. 6-9 in Boston, Dec. 13-16 in Washington, Jan. 17-20 in Los Angeles and Feb. 7-10 in Phoenix, Ariz.

Want to hook IBM?

Terminals. Personal Computers. ASCII devices. Hook them all into the IBM world with the new AVATAR™ PA1000 Protocol Converter.

The PA1000 provides low-cost IBM 3278/2 terminal emulation and coaxial connection to an IBM 3274/3276 cluster controller. Then, a single keystroke switches you back into the asynchronous world through an auxiliary RS-232-C port to access other computer systems, public information services or copy a screen to a printer.

Our microprocessor-based unit provides user-selectable rates up to 9600 baud, terminal keyboard configura-

tions, screen management and local or remote print functions. And, you can hook the PA1000 to a modem for remote dial-in access.

Simple, economical access to the world of IBM, just when you thought there was no answer. At \$995, getting hooked has never been so affordable. For more information on our AVATAR PA1000 Protocol Converter, contact 3R Computers, 18 Lyman St., Westboro, MA 01581.

Or call us at (617) 366-5300. TWX 710-390-0375.

AVATAR™

Making IBM smarter since 1983.

© 1983 RRR Computers, Inc. Avatar is a trademark of RRR Computers, Inc. IBM is a registered trademark of International Business Machines Corp.

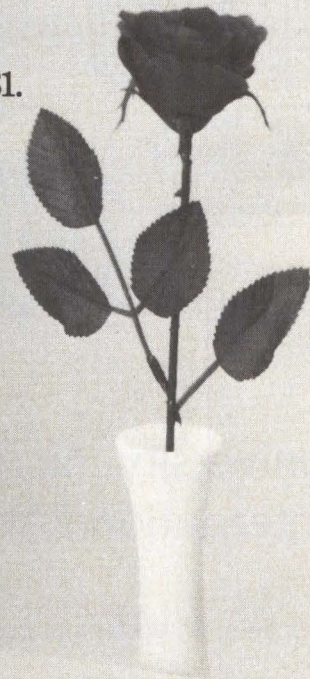

CIRCLE NO. 129 ON INQUIRY CARD

Calendar

This publication
is available in microform.

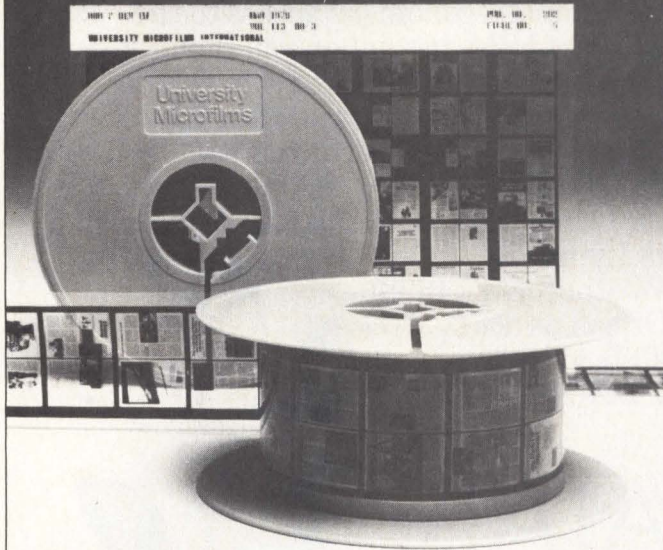

University Microfilms International

Please send additional information
for _____
(name of publication)

Name _____

Institution _____

Street _____

City _____

State _____ Zip _____

300 North Zeeb Road
Dept. P.R.
Ann Arbor, Mi. 48106
U.S.A.

30-32 Mortimer Street
Dept. P.R.
London W1N 7RA
England

- 16-18 "MVS/SP Internals Overview" Seminar, Atlanta, sponsored by ACTS Corp. Contact: Jeff Carico, ACTS Corp., 11910 Gate Way, Austin, Texas 78727, (512) 258-7869.
- 17-18 "Voice-Data Integration and the Digital PBX" Symposium, Washington, sponsored by Phillips Publishing Inc. Contact: Diane Pontisso, Seminar Coordinator, 7315 Wisconsin Ave., Suite 1200N, Bethesda, Md. 20814, (301) 986-0666.
- 17-19 Fifth Annual Northeast Computer Show and Software Exposition, Boston, sponsored by Northeast Expositions. Contact: Northeast Expositions, 822 Boylston St., Chestnut Hill, Mass. 02167, (617) 739-2000.
- 17-20 Computer Showcase Expo, Washington and Chicago, presented by The Interface Group Inc. Contact: Linda Yogel or Peter B. Young, The Interface Group Inc., 300 First Ave., Needham, Mass. 02194, (617) 449-6600 or (800) 325-3330.
- 20-22 Third Annual On-Farm Computer Use Conference and Trade Show, West Lafayette, Indiana, sponsored by School of Agriculture, Purdue University. Contact: Division of Conferences, Purdue University, West Lafayette, Ind. 47907, (317) 494-1177.

NOVEMBER 28 - DECEMBER 1

North American Telecommunications Association (NATA) Showcase, Washington, sponsored by NATA. Contact: Karen Palermo, NATA, 511 Second St. N.E., Washington, D.C. 20002, (202) 547-4450.

NOVEMBER 29 - DECEMBER 2

"Defining Software Requirements, Specifications & Tests" Course, Boston, sponsored by Integrated Computer Systems. Contact: Ruth Dordick, Integrated Computer Systems, 6305 Arizona Place, Los Angeles, Calif. 90045, (213) 450-2060. Also to be held on Dec. 6-9 in Washington, Dec. 13-16 in Los Angeles and Feb. 28 - March 2 in Washington.

"Database Management Systems—Mini, Micro & Distributed Applications" Course, Boston, sponsored by Integrated Computer Systems. Contact: Ruth Dordick, Integrated Computer Systems, 6305 Arizona Place, Los Angeles, Calif. 90045, (213) 450-2060. Also to be held Dec. 6-9 in Washington, Dec. 13-16 in San Diego, Jan. 17-20 in Palo Alto, Calif., Feb. 14-17 in Anaheim, Calif. and Feb. 28 - March 2 in Baltimore.

COMDEX/Fall '83, Las Vegas, Nev., produced by The Interface Group. Contact: The Interface Group, COMDEX/Fall '83, 160 Speen St., P.O. Box 927, Framingham, Mass. 01701, (617) 449-6600.

Motorola's powerful new VME/10™ is now developing at Kierulff.

Motorola's new VME/10 Micro-computer System is a compact, powerful desktop designer's workstation you can use for developing advanced microprocessor-based systems using Motorola's 8 and 16-bit microprocessors, microcomputers, and peripherals.

The VME/10 is equally at home at the heart of a VMEbus™ target system, or as an advanced development tool for 6800/68000 based designs. It's an ideal host system for the HDS-200 (M6805 Family) and HDS-400 (M68000 Family) real-time emulators. And with its power and flexibility, it's the obvious system designer's choice.

Best of all, perhaps, it's available now. From Kierulff.

See for yourself. In just 48 hours.

It's very easy to see for yourself just how powerful and versatile the VME/10 really is. Simply call your local Kierulff branch and ask for VME Express Service. Within 48 hours, we'll have a VME/10 ready for a demonstration. With a Kierulff systems specialist on hand to fully familiarize you with the system.

The VME/10 comes standard with an MC68010 16/32 bit microprocessor unit, an MC68451 memory management unit, and an industry-standard VMEbus interface with full bus arbitration logic and software controllable interrupter. A 384K dynamic RAM, 8K static RAM, two 28-pin sockets for ROM/PROM/EPROM storage up to 64K bytes for custom applications, and battery backed-up

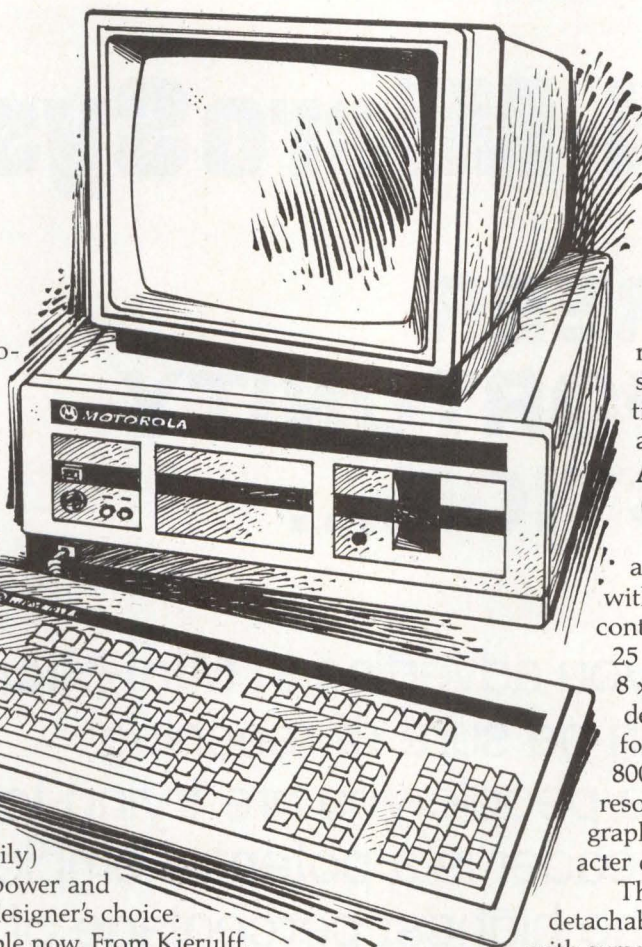

real-time clock are also standard. Motorola's real-time operating system is available now.

And it's ergonomic. Of course.

The VME/10 features a swivel 15" video display with the following software controllable display formats: 25 lines by 80 characters — 8 x 10 characters with descenders; 800 x 300 pixel for low resolution graphics; 800 x 600 pixel for medium resolution graphics; and pixel graphics with overlaid character displays.

The full ASCII keyboard is detachable, and comes complete with cursor control keys, numeric

pad, and 16 function keys. You even get a mass storage subsystem providing a 5¼" floppy disk and a 5¼" Winchester storage unit.

So call Kierulff today and ask for VME Express Service. And find out for yourself why the new VME/10 is the tool you've been looking for.

We think you'll agree some interesting things are developing between Kierulff and Motorola.

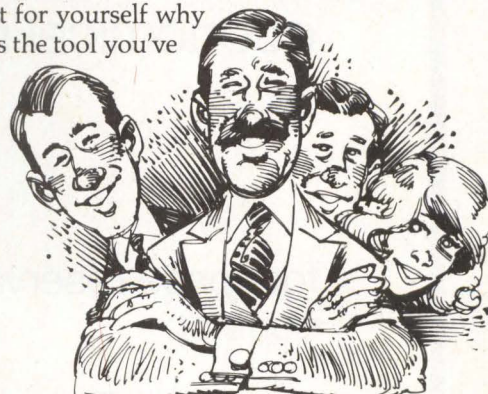

VME/10 and VMEbus are trademarks of Motorola, Inc.

KIERULFF

System Products Group

We help you put it all together.

Better.

AL Alabama (800) 237-8545 AR Arkansas (800) 331-3071
CA Los Angeles (213) 725-0325, (213) 994-0316, Palo
Diego (619) 278-2112, San Luis Obispo Zenith 19530,
Tustin (714) 731-5711 CO Englewood (303) 790-4444
DC Washington (301) 247-5020 DE Delaware (201) 575-6750
Miami and Palm Beach in State (800) 432-8028, St. Petersburg (813) 576-1966, (800) 282-8944
IL Elk Grove Village (312) 640-0200 IN Indiana (800) 323-0571 KS Kansas (800) 325-1039
ME Maine (800) 225-0692 MD Maryland (301) 247-5020 MI Michigan (800) 321-1436 MN Edina
(800) 237-8545 MT Montana (800) 525-1274 NB Nebraska (800) 525-1274 NC Greensboro (919) 852-9440 ND North Dakota (612) 941-7500 NH New Hampshire (800) 225-0692 NJ New Jersey (201) 575-6750 NM New
Mexico (800) 525-1274 NV Las Vegas (800) 528-4515, Reno (415) 968-6292 NY New York City (201) 575-6750, Upstate (617) 667-8331 OH Cleveland (216) 587-6558, In State (800) 362-1921, Out Of State (800) 321-1436
OK Tulsa (618) 252-7537, (800) 722-3900 OR Portland (503) 641-9150 PA Eastern (201) 575-6750, Western (800) 321-1436 RI Rhode Island (800) 225-0692 SC South Carolina (819) 852-9440 SD South Dakota (612) 941-7500
TN Eastern (919) 852-9440, Western (312) 640-0200, In State (800) 237-8545 TX Austin (512) 835-2090, Brownsville (512) 544-7212, Corpus Christi (512) 884-6167, Dallas (214) 343-2400, Houston (713) 530-7030, Laredo
(512) 726-1697, San Antonio (512) 349-0396, In State (800) 442-1041 UT Salt Lake City (801) 973-6913, In State (800) 662-8630, (800) 662-8631 VA Northern (703) 621-2592, Southern (800) 638-4994 VT Vermont
(800) 225-0692 WA Tukwila (206) 575-4420 WI Waukesha (414) 784-8160, (800) 242-6169 WY West Virginia (201) 575-6750 WY Wyoming (800) 525-1274 INTERNATIONAL: CA Compton (213) 774-7364, Telex:
69-1368, Outside Calif. (800) 421-2250

AZ Phoenix (602) 243-4101, Tucson (602) 624-9986
Alto (415) 968-6292, Sacramento (916) 924-8522, San
Santa Barbara Zenith 20014, Santa Maria Zenith 20014,
CT Wallingford (203) 265-1115, (800) 982-3901
FL Ft. Lauderdale (305) 486-4004, In State (800) 432-8028,
GA Georgia (800) 237-8545 IA Iowa (800) 328-6357 ID Idaho (800) 453-8067, (800) 453-8068
KY Kentucky (312) 640-0200 LA Louisiana (800) 237-8545 MA Billerica (617) 667-8331
(617) 941-7500 MO Maryland Heights (314) 739-0855, (800) 325-1039 MS Mississippi
(800) 237-8545 MT Montana (800) 525-1274 NB Nebraska (800) 525-1274 NC Greensboro (919) 852-9440 ND North Dakota (612) 941-7500 NH New Hampshire (800) 225-0692 NJ New Jersey (201) 575-6750 NM New
Mexico (800) 525-1274 NV Las Vegas (800) 528-4515, Reno (415) 968-6292 NY New York City (201) 575-6750, Upstate (617) 667-8331 OH Cleveland (216) 587-6558, In State (800) 362-1921, Out Of State (800) 321-1436
OK Tulsa (618) 252-7537, (800) 722-3900 OR Portland (503) 641-9150 PA Eastern (201) 575-6750, Western (800) 321-1436 RI Rhode Island (800) 225-0692 SC South Carolina (819) 852-9440 SD South Dakota (612) 941-7500
TN Eastern (919) 852-9440, Western (312) 640-0200, In State (800) 237-8545 TX Austin (512) 835-2090, Brownsville (512) 544-7212, Corpus Christi (512) 884-6167, Dallas (214) 343-2400, Houston (713) 530-7030, Laredo
(512) 726-1697, San Antonio (512) 349-0396, In State (800) 442-1041 UT Salt Lake City (801) 973-6913, In State (800) 662-8630, (800) 662-8631 VA Northern (703) 621-2592, Southern (800) 638-4994 VT Vermont
(800) 225-0692 WA Tukwila (206) 575-4420 WI Waukesha (414) 784-8160, (800) 242-6169 WY West Virginia (201) 575-6750 WY Wyoming (800) 525-1274 INTERNATIONAL: CA Compton (213) 774-7364, Telex:
KIERULFF, A DIVISION OF DUCOMMUN INCORPORATED

Get results with

Mini-Micro Systems

CAREER OPPORTUNITY SECTION...

When you advertise in **Mini-Micro Systems**, you can be sure of reaching only the people you are trying to recruit. Every reader is a potential employee. We reach the highest percentage of all significant personnel in our industry. You'll find us not only effective, but a more economical magazine.

for space reservation
contact:

Peggy Gordon
203-964-0664

New Products

SYSTEMS

Multiuser system runs industry-standard software

The Omnix 186 multiuser, 16-bit desktop business system uses the 80186 microprocessor to run industry-standard operating systems, programming languages and commercial application programs for users with heavy data- and word-processing work loads.

The system supports four to 16 terminals and printers in concurrent processing operations. It uses a user-transparent, 16-bit I/O processor for disk and terminal management that lets the 80186 deal exclusively with its multiple application tasks. An optional 8087 numeric processor extension provides a high-speed number-crunching capability for floating-point operations.

System integrators can choose from the CP/M-86, MP/M-86, Concurrent CP/M and OPUS-1 operating systems. Languages include CBASIC-86, COBOL, FORTRAN, Pascal and Trans-BASIC, the vendor's business language compiler with multikey ISAM file manager.

Omnix 186 systems offer a combination of 1M-byte, 5¼-inch floppy disk and one or two 5¼-inch Winchester disk drives, or a Winchester disk drive and a ¼-inch streaming-tape drive. Winchester drives are available in 5M-, 10M-,

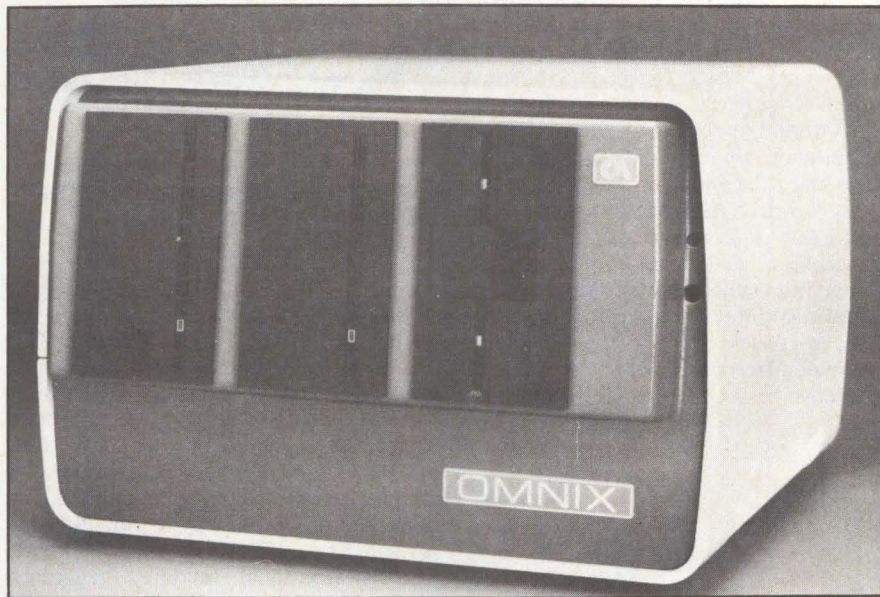

Computer Automation's Omnix 186 16-bit desktop business system offers a wide choice of operating systems and languages and various combinations of floppy and Winchester disk drives or Winchester disk and streaming-tape drives.

15M- and 20M-byte (formatted) capacities. All systems include 384K bytes of RAM and four serial ports, expandable to 16 in groups of four.

Prices begin at \$8,990 for the smallest

Omnix 186 with a 5M-byte Winchester disk drive and a 1M-byte floppy disk drive. **Computer Automation Inc.**, 18651 Von Karman Ave., Irvine, Calif. 92713, (714) 833-8830. **Circle No 300**

UNIX workstation aimed at scientific markets

The Unistar 100 single-user and Unistar 200 multi-user workstations are 68000-based microcomputers designed to provide speed and versatility for the scientific, industrial and commercial markets. The systems include an intelligent video terminal, integrated disk storage, a microprocessor CPU and the UNIX operating system. The Unistar's Multibus architecture, optional Tektronix 4010-compatible graphics controller and wide array of programming languages, including a C compiler, FORTRAN 77, Pascal, COBOL, Ada and BASIC, are keys to its flexibility. Hardware features include a 12-in. green CRT screen, a detached keyboard, a 5¼-in., 600K-byte floppy disk drive and a 5¼-in. Winchester disk drive that stores 10M bytes on the Unistar 100 and



21M bytes on the Unistar 200. Main memory sizes are 256K bytes on the Unistar 100 and 512K bytes on the Unistar 200, and both are expandable to 1M byte. Single-unit prices are \$9950 for the Unistar 100 and \$13,950 for the Unistar 200. **Callan Data Systems**, 2645 Townsgate Rd., Westlake Village, Calif. 91361. **Circle No 301**

Virtual-memory computers run UNITY

The Mega series 32-bit, virtual-memory microcomputers incorporate National Semiconductor Corp.'s NS16032 CPU with true 32-bit internal logic, an internal data path configured on the Multibus (IEEE 796) 16-bit interface and demand-paged virtual memory and 64-bit double-precision, floating-point arithmetic implemented in hardware. MegaMicro computers can perform 161,000 64-bit, double-precision multiplications per sec. The virtual-memory feature allows each user to compute as if he had 16M bytes of both program and data space. Mega series computers support as many as 32 simultaneous users per processor, and multiple processors can be linked so that an unlimited number of users can share resources. Because the NS16032 instruc-

New Products

SYSTEMS

tion set is symmetrical, the processor is suited to high-level languages such as FORTRAN, C and Pascal and to structured, modular programming. The MegaMicro 16032 computer runs Human Computing Resources' UNITY operating system that implements Berkeley's 4.1 enhancements of Bell Laboratories' UNIX. Priced at \$15,000, a typical MegaMicro computer includes an LMC 16032 processor board with virtual-memory and floating-point hardware and 512K bytes of parity-checking RAM, eight RS232 I/O ports, an intelligent disk controller, a 20M-byte Winchester disk drive, the UNITY operating system with supporting utilities, C and FORTRAN compilers and a case, a power supply and manuals. **Logical Microcomputer Co.**, 140 S. Dearborn St., Chicago, Ill. 60603.

Circle No 302

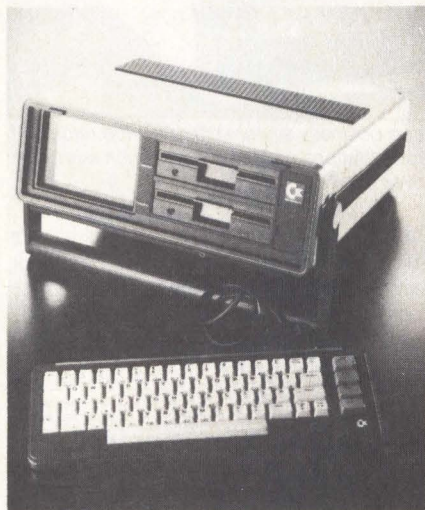

Portable computer expands Commodore's 64 line

The Executive 64 portable computer comprises a 6510 CPU, 64K bytes of RAM, a low-profile, detachable keyboard, a 6-inch color monitor and a 170K-byte floppy disk drive. The unit weighs 27.6 pounds and measures 5 by 14½ by 14½ inches. External ports allow full-sized monitor and graphic printer hookups. Using a z80 cartridge, the computer accommodates the CP/M operating system. BASIC V2 is resident in the unit's ROM. \$995. **Commodore Business Machines Inc., Computer Systems Division**, 1200 Wilson Dr., West Chester, Pa. 19380, (215) 431-9100.

Circle No 303



Desktop system supports 8-, 16-bit environments

The SuperSystem II model 8/16 desktop computer runs in 8- and 16-bit environments using Intel's 80186 microprocessor. The unit supports the CP/M-86 operating system, Microsoft products, CBASIC II, FORTRAN, COBOL, Pascal and PL/1-80. Mass storage capacities range from 700K to 52M bytes. Other features include a parallel printer port, an RS232 communications port and an optional synchronous port. \$3,995 to \$7,995. **CMC International**, CMC International Building, 1720 130th Ave. N.E., Bellevue, Wash. 98005, (206) 885-1600.

Circle No 304

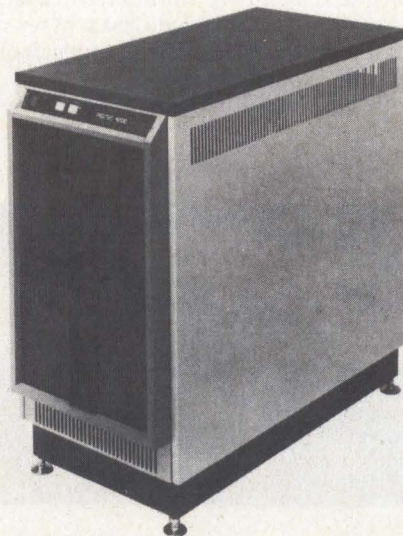

Business computers run Pick operating system

The 10-MHz MC68000-based system 4200 product line supports as many as 35 terminals, running under the Pick operating system. The desktop model 4220, accommodates three to 11 terminals/printers linked to the host via

RS232C interfaces; the floor-cabinet model 4240 accommodates 11 to 35 terminals/printers. Both models have 256K bytes of RAM, Winchester disk drives and a ¼-inch cartridge-tape drive. A seven-slot chassis on the 4220 and an 11-slot chassis on the 4240 allow expansion. \$13,000. **Pertec Computer Corp.** 17112 Armstrong Ave., Irvine, Calif. 92714, (714) 540-8340.

Circle No 305

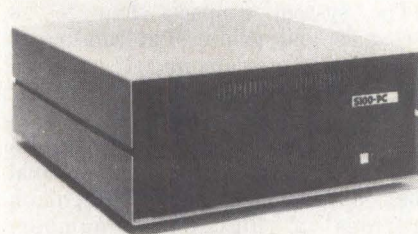

8088-based microcomputer runs MS-DOS

Housed in a 15-slot desktop enclosure, the S100-PC computer system comprises an 8-MHz 8088 microprocessor, 128K bytes of RAM, two RS232 ports, two parallel ports, a battery-protected clock/calendar, an EPROM monitor with built-in diagnostics, the MS-DOS operating system and two double-sided, 5¼-inch floppy disk drives that store 640K bytes. Options include memory expansion to 1M byte, battery-protected CMOS RAM and an 8089 I/O coprocessor. CP/M-86, MP/M-86 or Concurrent CP/M-86 can be substituted for the MS-DOS operating system at additional cost. \$1,895 (100 units). **Lomas Data Products Inc.**, 66 Hopkinton Rd., Westboro, Mass. 01581, (617) 366-6434.

Circle No 306

Supermicrocomputer runs virtual-memory UNIX

The Pixel 80 supermicrocomputer system uses Motorola Inc.'s 68010 processor with a separate I/O processor to run a virtual-memory version of UNIX System III with Berkeley enhancements. In its maximum configuration, the Pixel 80 offers 16-terminal capability, 6M bytes of RAM and 720M bytes of Winchester disk storage. Targeted to OEMs and system integrators, the Pixel 80 is supported by a large selection of third-party software, including the MicroINGRES and UNIFY relational database-management systems, MDBS

III, SMC IDOL, five word-processing packages, general accounting packages and BASIC 5 financial applications. High-level programming languages including C, Pascal, Ada, APL, FORTRAN 77 and several versions of COBOL and BASIC, are available. The Pixel 80 supermicrocomputer, including UNIX System III, a 10-MHz 68010 processor, 512K bytes of RAM, a 38M-byte hard disk drive and a selection of backup devices, is priced at \$13,900 in single-unit quantities. **Instrumentation Laboratory Inc., Pixel Division**, One Burt Rd., Andover, Mass. 01810.

Circle No 307

Computer incorporates Fairchild microprocessor

Using a 16-bit Fairchild 9445 microprocessor with 128K bytes of RAM, the M1 series desktop computer supports as many as five users. It is available in three models—the M1/10, M1/34 and

M1/68—with 10M, 34M and 68M bytes of Winchester disk storage, respectively. All models have a 20M-byte, ¼-inch streaming-tape drive that operates at 90 ips. They also offer the IRIS or BITS operating system, five serial ports, one parallel printer interface and a real-time clock. Prices start at \$12,000 for the model M1/10, with quantity discounts available. **Microtech Business Systems**, 3180 Pullman St., Costa Mesa, Calif. 92626, (714) 557-8640.

Circle No 308

Portable computer has networking capability

The TeleTote I portable computer weighs 25 pounds and has a 9-inch video display screen with 640-by-240 graphics resolution. The screen displays 24 lines of text with 80 characters per line. An optional RS422 network port links the TeleTote I to a TeleVideo network for access to shared files, printers and

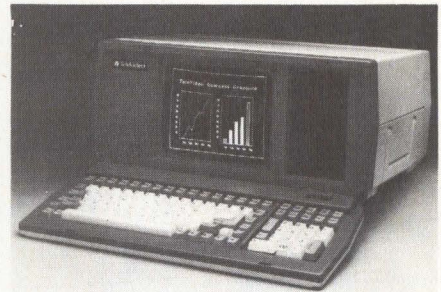

electronic mail. Hardware highlights encompass a Z80A CPU; 64K bytes of RAM, expandable to 128K bytes; a 368.6K-byte (formatted) 5¼-inch floppy disk drive; a SuperMouse port and two RS232 printer/modem ports. CP/M, GSX-80 graphics extension, word-processing, spreadsheet and graphics software are included. \$1,499, one disk drive; \$1,899, two disk drives. **TeleVideo Systems Inc.**, 1170 Morse Ave., Sunnyvale, Calif. 94086, (408) 745-7760.

Circle No 309

This publication
is available
in microform.



University Microfilms International

300 North Zeeb Road
Dept. P.R.
Ann Arbor, Mi. 48106
U.S.A.

30-32 Mortimer Street
Dept. P.R.
London W1N 7RA
England

CIRCLE NO. 8 ON INQUIRY CARD

MINI-MICRO SYSTEMS/ November 1983

UNIVAX Your PDP

Put the speed and performance of a VAX and the power of the UNIX* operating system in your PDP-11/23 with Cambridge Digital's new UniVax board.

Our 32-bit, MC68000-based UniVax features a throughput that approaches 1 MIPS, a complete memory management unit that provides 16 Mbytes of logical address space within the 4 Mbytes physical address space of the Qbus, a dual bus architecture with a dual port memory that allows uninterrupted high speed I/O transfer and direct memory access. Plus, the UNIX operating system, all on a single quad board designed to replace your present PDP-11/23 processor module.

Protect your PDP investment, call Cambridge Digital Systems today for our new system catalog.

Main Office Dept. 7401,
P.O. Box 568, 65 Bent St.
Cambridge, Massachusetts 02139.
Telex 92-1401/COMPUMART CAM.
800-343-5504.

In Mass. call 617-491-2700.
New York District Office
516-935-3111.

**Cambridge
Digital**
DIVISION OF COMPUMART

The Edge in System Integration.

800-343-5504

*UNIX is a trademark of Bell Laboratories.

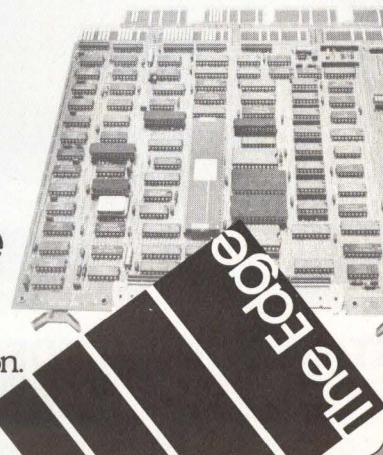

CIRCLE NO. 133 ON INQUIRY CARD

New Products

SYSTEMS



Microcomputer features UNIX

The model 32/4 MC68000/UNIX-based microcomputer workstation offers direct-memory access, a proprietary memory-management unit and 0.5M bytes of 150-nsec. main memory. The four-board system also includes an alphanumeric display controller board, a 12-inch green phosphor screen, a

keyboard and two 5M-byte, 3.9-inch Winchester disk cartridge drives. Four serial ports, as well as an SASI interface, provide support for three additional user terminals and a printer. UNIX, C, word-processing and spreadsheet software are supplied. \$4,495 (OEM quantities). **Momentum Computer Systems International**, 965 W. Maude Ave., Sunnyvale, Calif. 94086, (408) 245-4033.

Circle No 310

Single-board computer employs R6511Q micro

The Cmc SBC6511 single-board computer uses Rockwell International's R6511Q microprocessor. It incorporates an enhanced version of the standard 6502 instruction set and has an on-chip clock, an asynchronous serial port, an event counter, a timer and 192 bytes of RAM. The board carries the R6511Q CPU, power supply, address decoders, a 1.8432-MHz crystal, serial-port operation to 19.2K baud, an eight-position

CPU-readable DIP switch, expansion ports and sockets for 2K bytes of RAM and as much as 8K bytes of ROM. An IEEE-488 (GPIB) interface, an RS232 interface and a development board with monitor, trace and disassembler are optional. \$189. **Connecticut microComputer Inc.**, 36 Del Mar Ave., Brookfield, Conn. 06804, (203) 775-4595.

Circle No 311

Portable microcomputer runs IBM PC software

The AJ Passport portable personal computer runs application software written for the IBM PC. It weighs 20 pounds and occupies 18 inches of desk space. It has 256K bytes of internal RAM, two 320K-byte floppy disk drives and a 7-inch amber screen. The product uses an 8088 microprocessor and comes with MS-DOS and an Advanced Disk BASIC interpreter with graphics support. With two floppy disk drives, a parallel printer

OUTSTANDING STAND-ALONE BOARDS.

SMC's Stand-Alone boards stand out in the crowd. Our **HAWK I** Video Terminal Board provides all the circuitry to build a "SMART" CRT Terminal, featuring enhanced video attributes and screen editing capabilities. Our **ARCNET-LINK** Board connects any computer with an RS-232 port to a high-performance ARCNET® local area network. For complete details, contact Standard Microsystems Corporation, 35 Marcus Boulevard, Hauppauge, NY 11788 (516) 273-3100.

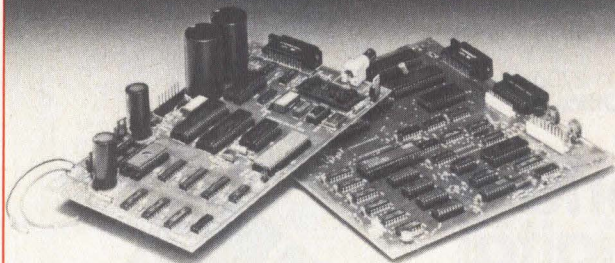

**STANDARD MICROSYSTEMS.
THE ONE TO WATCH.**

ARCNET® is a registered trademark of the Datapoint Corporation

CIRCLE NO. 134 ON INQUIRY CARD

Miniature coreless DC motors with maximum torque!

Namiki mini-motors are precision engineered with unique Naminet® rare-earth cobalt magnets. They provide high performance, low inertia and minimal current consumption. Other features are ultra-smooth, quiet operation and longer motor life. The motors come in standard sizes from 10 mm (.394") to 22 mm (.866") dia., provide 3,900 to 31,000 RPM. Interchangeable gear boxes are available for lower RPM's and higher torque. Write today for a free catalog. **Namiki Precision Jewel Co., Ltd.**, 15 Essex Road, Paramus, N.J. 07652. Or call us at 201-368-8310.



NAMIKI

82-1

CIRCLE NO. 139 ON INQUIRY CARD

port, a serial communications port, a time and date clock with battery backup, a 300-baud auto-dial/auto-answer modem and operating and application software, it sells for approximately \$4,500. **Anderson Jacobson Inc.**, 521 Charcot Ave., San Jose, Calif. 95131, (408) 286-7960.

Circle No 312

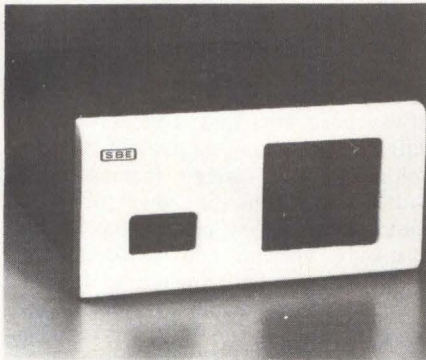

16-/32-bit microcomputer works on Multibus

Available in a rack-mount enclosure, the SBE 200 16-/32-bit microcomputer contains 256K bytes of dual-ported RAM, a 5¼-inch, 320K-byte floppy disk drive and a 5¼-inch, 10M-byte Winchester disk drive. Its ModulasTen M68K10 board offers a 10-MHz MC68000 microprocessor, a 24-bit parallel I/O, two RS232C ports, an SBEX-SASI board for connection to disk controllers and Multibus compatibility. Regulus (UNIX-like), CP/M-68K and pFORTH 32 are available. \$4,695 (25 units). **SBE Inc.**, 4700 San Pablo Ave., Emeryville, Calif. 94608, (415) 652-1805.

Circle No 313

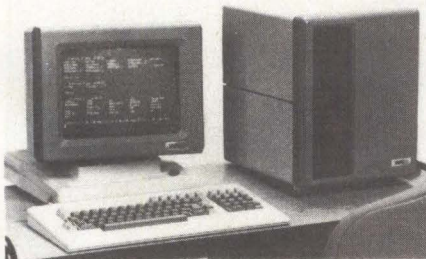

Microcomputers target system integrators

Suited for value-added resellers, the VAR/68 series computers include a 6809 CPU, 128K bytes of RAM, eight serial ports, one parallel port and an

ergonomic video display and keyboard. The computers come with various combinations of 750K-byte floppy disk drives and 5M- or 20M-byte Winchester disk drives. Software offerings include a structured BASIC with Pascal-type data structures as well as COBOL, Pascal and C compilers. The computers run

OS9-Level 2, a UNIX-like multiuser, multitasking operating system featuring password protection, record-level lock out and dynamic memory allocation. \$4,325 to \$10,585. **Smoke Signal Broadcasting**, 31336 Via Colinas, Westlake Village, Calif. 91362, (213) 889-9340.

Circle No 314

SEATTLE GIVES YOU AN EDGE IN S-100 SYSTEM DESIGNS

You can unlock new system capabilities with high-performance S-100 boards from Seattle Computer. All are IEEE-696 compatible. But, for innovative systems that demand performance beyond the limits of conventional S-100 boards, you'll want to know more about these Seattle Computer products. For example, with our 8 MHz 8086 CPU, you'll be able to build systems that run faster and consume less power than before. Take a closer look:

8086 CPU Set: 8 MHz 8086 CPU • CPU Support board includes a console serial port, a second serial port, Centronics parallel port, vectored interrupt controller, four 16-bit timers and EPROM monitor for 8086 • MS-DOS 2.0 plus development utilities • 8087 numeric coprocessor is optional
• **Single Qty: \$595.00**

64k Static RAM Fully static design makes interfacing easy • Compatible with a variety of CPU and DMA devices • High-speed (85 ns) RAMs operate to 10 MHz with no wait states • 16k, 32k, and 48k OEM versions are available
• **Single Qty: \$495.00 (64k)**

Disk Master™ Controls as many as four 8" and four 5.25" floppy disk drives simultaneously, in any combination • Uses 1793 disk controller chip • Can be used with 10 MHz CPUs • **Single Qty: \$325.00**

Multi-Port Serial Card 2- and 4-port versions are available • These RS-232 ports operate as either "data sets" or "data terminals" • 36" cables included
• **Single Qty: \$280.00 (4-port)**
\$210.00 (2-port)

For the whole story on high-performance Seattle Computer S-100 boards, call:

1-800-426-8936

Dealer and OEM inquiries are invited.

CIRCLE NO. 140 ON INQUIRY CARD

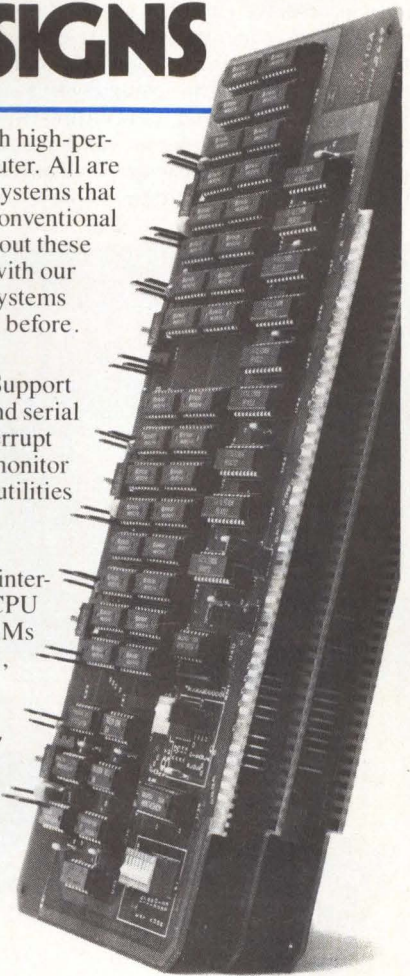

**SEATTLE
COMPUTER**

1114 Industry Drive
Seattle, WA 98188

New Products

DISK/TAPE

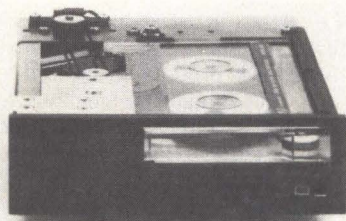

Streaming tape drives are half-height

The Scorpion family of half-height 1/4-in. streaming cartridge-tape drives enables designers to integrate streaming tape with half-height Winchester drives or with floppy disk drives in 5 1/4-in. cabinets. Featuring LSI electronics technology, the drive's controller and motor-drive circuitry are contained on a 5- x 7-in. board that can be packaged separately from the drive mechanics. Like the company's 8-in. family of streaming cartridge-tape drives, the Scorpion series can back up 5M- to 50M-byte capacity Winchester disk drives at transfer rates of 5M bytes

per min. The series is available in two models that have formatted storage capacities of 20M or 45M bytes. Drives use the industry-standard Archive (QIC II) Sidewinder interface and are interface compatible with other products from the vendor. Prices start at \$800 in OEM quantities. **Archive Corp.**, 3540 Cadillac Ave., Costa Mesa, Calif. 92626. **Circle No 315**

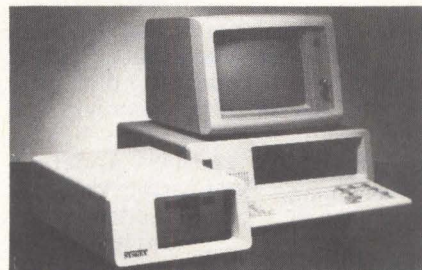

Winchester systems for PC include cassette backup

The Sysgen II series of mass-storage memories for the IBM Personal Computer features streaming-tape cassette backup. The two Winchester-type drives in the series provide formatted storage capacities of 10M or 20M bytes. The streaming-tape cassette subsystem performs backup operations at rates as high as 2.5M bytes per min. The Sysgen II series is compatible with PC-DOS or CP/M-86 operating systems. Its hard disk systems can be configured in as

many as 10 logical volumes under PC-DOS and as many as 14 logical volumes under CP/M-86. The number and size of these logical drives are user selectable. Sysgen II systems include utility programs that save and restore data on volumes equivalent to disk volumes in an image fashion or as individual files or sets of files. Single-unit prices are \$2995 for the 10M-byte version and \$3795 for the 20M-byte version, including IBM PC interface card, cables and software. **Sysgen Inc.**, 47853 Warm Springs Blvd., Fremont, Calif. 94539. **Circle No 316**

NOW IBM-TYPE PERSONAL COMPUTERS CAN GO PUBLIC.

SMC's **ARCNET-PC** board provides a simplified interface between the IBM® Personal Computer (PC) bus and an ARCNET® token passing local area network. It connects up to 255 computers and permits them to share disk files and printer resources, as well as send electronic mail to any system on the network. It does all this at a high performance 2.5 Megabit data rate, yet at a low cost due to the use of SMC's VLSI local area network chip set. For complete details, contact Standard Microsystems Corporation, 35 Marcus Boulevard, Hauppauge, NY 11788 (516) 273-3100.

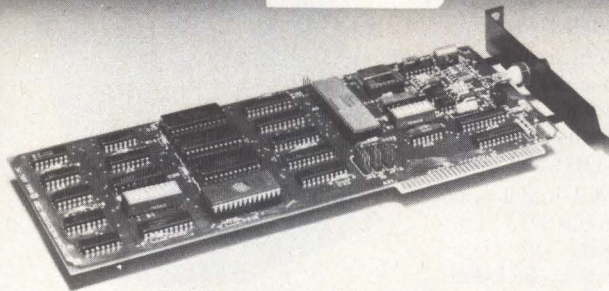

STANDARD MICROSYSTEMS. THE ONE TO WATCH.

IBM® is a trademark of the International Business Machine Corporation
ARCNET® is a registered trademark of the Datapoint Corporation

CIRCLE NO. 135 ON INQUIRY CARD

This announcement appears as a matter of record only.

New Issue

September 16, 1983

\$6,686,500



brown disc manufacturing, inc.

Series B Convertible Preferred Stock

The undersigned has arranged the private placement of these securities.

Boettcher & Company

CIRCLE NO. 141 ON INQUIRY CARD

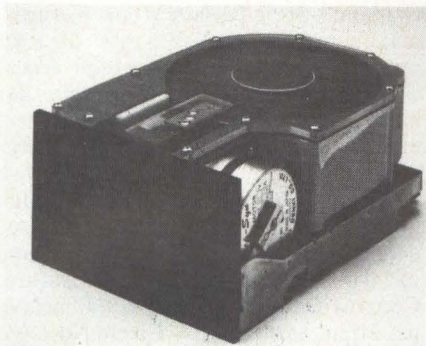

Winchesters take aim at small-business computers

The D5200 family of 5¼-inch Winchester disk drives comprises four models with unformatted storage capacities of 6.4M, 12.9M, 19.3M and 25.8M bytes. The drives have 85-msec. average access times and 5M-bit-per-second data-transfer rates. They are available with an industry-standard interface. Features include a direct-drive DC spindle

motor, microprocessor controls and LSI circuits and an MTBF rating of 12,000 power-on hours. \$915 to \$1,410 each (100 units). **NEC Information Systems Inc.**, 5 Militia Dr., Lexington, Mass. 02173, (617) 862-8120. **Circle No 317**

Winchesters boast 32-msec. access times

The 500 series of 5¼-inch Winchester disk drives includes four models with unformatted storage capacities ranging from 55M to 111M bytes. Model 502 stores 55M bytes on four disks; model 504 stores 86M bytes on six disks. Both drives are compatible with the ST412/506 interface. Models 503 and 505 have higher recording densities to get 71M and 111M bytes of storage capacity on four and six disks, respectively. These drives feature on-board data separation and are available with Priam and ANSI interfaces. The 502 and 504 offer 625K-byte-per-second data-transfer rates, and the 503 and 505 offer

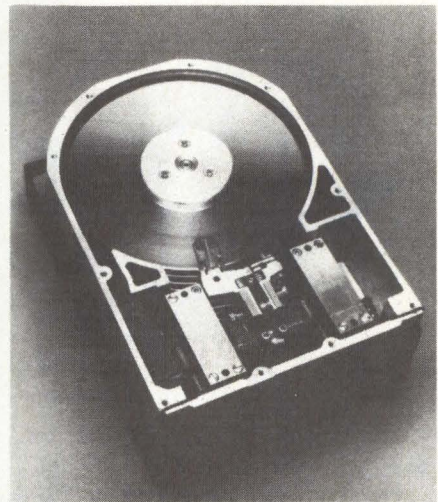

806K-byte-per-second transfer rates. All units have 32-msec. average access times. \$1,550 to \$2,500 (500 units). Delivery: second quarter, 1984. **Priam Corp.**, 20 W. Montague Expressway, San Jose, Calif. 95134, (408) 946-4600. **Circle No 318**

This publication is available in microform.



University Microfilms International

300 North Zeeb Road
Dept. P.R.
Ann Arbor, Mi. 48106
U.S.A.

30-32 Mortimer Street
Dept. P.R.
London WIN 7RA
England

CIRCLE NO. 7 ON INQUIRY CARD

MINI-MICRO SYSTEMS/ November 1983

TAP Into TOWER

And, tap into the Cambridge Digital "Edge." Yes, Cambridge Digital is now the East Coast distributor of NCR's Tower products. For the first time, system builders from Maine to Virginia can get the best computer system in the industry, combined with the famous "Edge."

The Tower gives you the performance of the 68000 processor, the flexibility of multibus architecture, and the power of *UNIX in a single system. The "Edge" gives you the assurance that your system is fully tested and ready to run the day of delivery. Add NCR service, and you have a system builder's dream.

Our complete system package delivers the performance of a mini-computer at the size and price of a micro, coupled with a support and service organization that guarantees your system is up and running anywhere in the world.

For more information call or write.

Main Office Dept. 7401,
P.O. Box 568, 65 Bent St.
Cambridge, Massachusetts 02139.
Telex 92-1401/COMPUMART CAM.
800-343-5504.

In Mass. call 617-491-2700.
New York District Office 516-935-3111

Cambridge Digital
DIVISION OF COMPUMART

The Edge in System Integration.

800-343-5504

*UNIX is a trademark of Bell Laboratories.

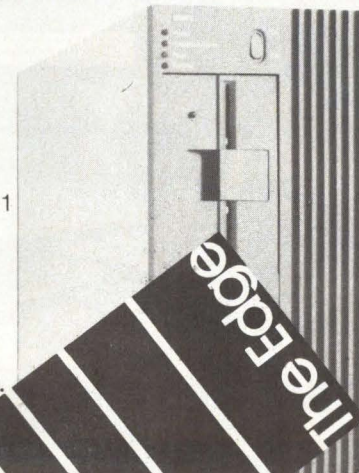

CIRCLE NO. 142 ON INQUIRY CARD

New Products

DISK/TAPE

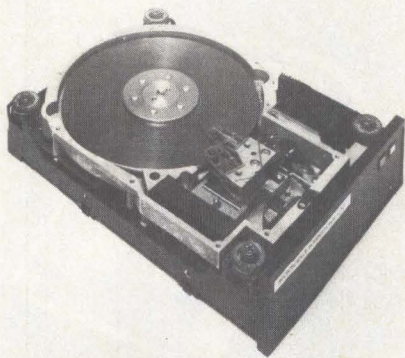

Half-height Winchester stores 10M bytes

The HH-612 half-height 5¼-inch Winchester disk drive stores 10M bytes of formatted data. Measuring 1.63 by 5.75 by 8 inches, weighing 3 pounds and requiring 0.9A DC, the HH-612 suits small-business systems and personal and portable computers. It features thin-film-plated disks, microprocessor-

controlled spindle motor and servo positioning, a thermally isolated stepper motor with a patented band actuator, embedded guard bands and on-board self-diagnostics. \$999. **Microscience International Corp.**, 575 E. Middlefield Rd., Mountain View, Calif. 94043, (415) 961-2212. **Circle No 319**

Disk systems for Series/1 store 126.4M bytes

The Certainty 231 and 241 Series are families of sealed-module, random-access disk storage systems that attach to the IBM Series/1 minicomputer. The systems store 63.2M or 126.4M bytes of data. Each system consists of a disk storage device, an attachment controller and all hardware for installation in the Series/1 4997 rack enclosure. The attachment controller operates in the Series/1 cycle-steal mode, allowing multiple-sector disk transfers and has initial program-load capability. Both

Certainty Series disk systems feature a maximum data-transfer rate of 1.2M bytes per sec. and an average access time of 30 msec. The Certainty 241 models also feature 0.6M bytes of double-sided floppy-disk storage. Prices of the Certainty 231 and 241 disk systems, in quantities of five through nine, range from \$12,325 to \$19,200 depending on storage capacities and inclusion of the floppy disk feature. **Control Data Corp.**, Box 0, Minneapolis, Minn. 55440. **Circle No 320**

Cartridge-tape streamer stores 45M bytes

The model DSC 50X ¼-inch streaming cartridge-tape subsystem for the IBM Series/1 computer consists of a single-board Datum tape controller, an Archive ¼-inch cartridge streaming-tape transport, a power supply, software and cables. The controller board mounts directly in the Series/1's

S100 CONTROLLER BOARDS BUILD MORE VERSATILE SYSTEMS.

SMC's S100 controller boards present new opportunities in system design. Our **QSI05100** board provides 4 independent serial I/O channels for simultaneous use of a variety of peripherals. The **FDCS100** board controls up to 4 floppy disk drives for removable mass storage capability. The **VRAMS100** board adds advanced video display capabilities, including smooth scrolling and double-height, double-width data rows. Our **ARCNET®-S100** board links up and controls a network of up to 255 computers. For complete details, contact Standard Microsystems Corporation, 35 Marcus Boulevard, Hauppauge, NY 11788 (516) 273-3100.

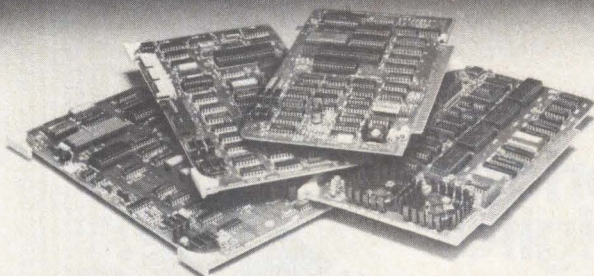

STANDARD MICROSYSTEMS. THE ONE TO WATCH.

ARCNET® is a registered trademark of the Datapoint Corporation

CIRCLE NO. 137 ON INQUIRY CARD

STATEMENT OF OWNERSHIP

Statement of Ownership. Management and Circulation required by the Act of Congress of August 24, 1912, as Amended by the Acts of March 3 and July 12, 1946 and October 23, 1962. (Title 39 United States Code, Section 3685) of MINI-MICRO SYSTEMS (USPS 059-470), published monthly (12 issues annually) at 270 St. Paul, Denver, CO. 80206 for September 1983. Annual Rates: \$45 US; \$50 Can.; \$65 Foreign.

- Names and complete addresses of the Publisher, Editor, and Managing Editor are: Vice President and Publisher, S. Henry Sacks, 221 Columbus Ave., Boston, MA 02116. Editor-in-chief, George V. Kotelly, 221 Columbus Ave., Boston, MA 02116. Managing Editor, James F. Donohue, 221 Columbus Ave., Boston, MA 02116.
- The owner is Cahners Publishing Co., a division of Reed Holdings, Inc., 221 Columbus Ave., Boston, MA 02116.
- The known bondholders, mortgages, and other security holders owning or holding 1 percent or more of total amount of bonds, mortgages, or other security are: None.

Extent and Nature of Circulation

	Average No. Copies Each Issue During Preceding 12 Months	Actual No. Copies of Single Issue Published Nearest to Filing Date
A. Total No. Copies Printed (Net Press Run)	121,456	124,373
B. Paid Circulation		
1. Sales through dealers & carriers, street vendors and counter sales	None	None
2. Mail Subscriptions	2,320	2,515
C. Total Paid Circulation	2,320	2,515
D. Free distribution by mail, carrier, or other means samples, complimentary, and other free copies	118,188	120,796
E. Total Distribution (Sum of C & D)	120,508	123,311
F. Copies not distributed		
1. Office use, left over, unaccounted, spoiled after printing	948	1,062
2. Returns from news agencies	None	None
G. Total	121,456	124,373

I certify that the statements made by me above are correct and complete. Robert LaFemina, (signed) Manager, Administrative Services.

MINI-MICRO SYSTEMS/November 1983

processor chassis, and a separate 5¼-inch-high enclosure houses the remaining components. The tape drive stores 45M bytes of formatted data on nine tracks. Recording density is 8,000 bpi; data-transfer rate is 5M bytes per minute. \$5,000. **Datum Inc.**, 1363 S. State College Blvd., Anaheim, Calif. 92806, (714) 533-6333. **Circle No 321**



Winchester stores 190M bytes on eight disks

The XT-2000 family of 5¼-inch Winchester disk drives includes models with unformatted storage capacities of 85M bytes (four disks), 140M bytes (six disks) and 190M bytes (eight disks). The drives incorporate the ST506/412 interface and have data-transfer rates of 5M bits per second. Average access time is 30 msec. The drives also feature a 3380 Whitney-type ceramic mini-composite head slider. Using a ferrite read/write element, the slider records 1,224 tracks per disk surface. Track density is 980 tpi. \$1,670 to \$2,995 (1,000 units). Delivery: first quarter, 1984. **Maxtor Corp.**, 61 E. Dagget Dr., San Jose, Calif. 95134, (408) 942-1700.

Circle No 322

Tape subsystem stores 40M bytes

Designed for use with the IBM PC and the IBM PC XT, the TD-1012/PC-STR ½-inch tape subsystem operates in start/stop (12.5 ips) and streaming modes (100 ips) and supports industry-standard IBM/ANSI/ECMA tape formats.

The recording mode is standard phase encoded PE at 1600 bpi. Data-transfer rate is 20K bytes per second in start/stop mode and 160K bytes per second in streaming mode. The unit accepts 7- to 10½-inch-wide industry-standard tape reels and stores approximately 40M bytes of formatted data

(depending on block size) on a 2,400-foot reel of tape. The system includes a tape controller board and a software-driver package for read/write/control. \$4,995. **Innovative Data Technology**, 4060 Morena Blvd., San Diego, Calif. 92117, (619) 270-3990.

Circle No 323

VMEbus MEMORIES

512K BYTES NOW... 2M BYTES LATER

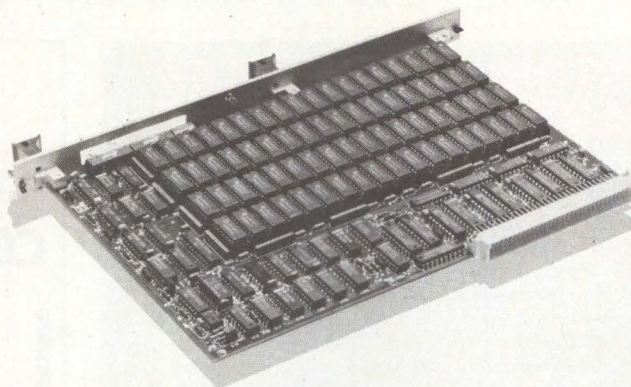

Compatible with the VME/10 micro-computer system and MVME210 memory board, the MM-6000D is a high density memory that can employ either 64K or 256K DRAMs. A jumper option selects either 64K or 256K DRAM operation.

Reliability is ensured by burn-in and running memory diagnostics that check operation for 48 hours while temperature-cycling boards between 0 and 65°C.

FEATURES

- Capacity: 512K, 256K, 128K Bytes (64K DRAM) 2M, 1.5M, 1M Bytes (256K DRAM)
- Cycle Time: 330 nsec
- Access Time: 210 nsec
- Parity generation and checking
- Module selection on 1000_H boundaries in the 16M bytes address field
- Single +5V supply
- Jumper option for battery backup
- 1-year warranty on parts and labor

First in add-in memories for microprocessor systems

**micro
memory
inc**

9436 Irondale Ave.
Chatsworth, California 91311

Telephone: (213) 998-0070

New Products

DISK/TAPE

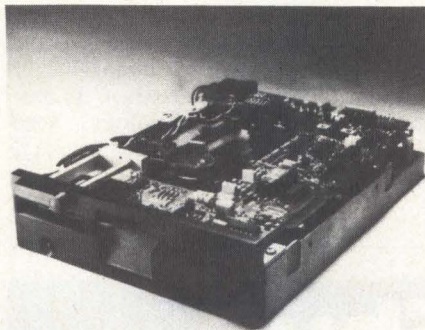

Floppy drives feature ball-bearing carriage

The Echo 500 family of 5¼-inch, half-height floppy disk drives employs a ball-bearing coupled carriage to achieve precision track-to-track positioning and low-noise drive stepping. Storage capacities range from 1.6M bytes (unformatted) for the double-sided, double-density, 96-tpi model to 125K bytes (unformatted) for the single-

sided, single-density 48-tpi model. Track-to-track access times are 3 msec. for the 96-tpi models and 6 msec. for the 48-tpi models. Data-transfer rates range from 500K to 125K bits per second. Prices start at \$95 to \$225 (large OEM quantities). **Hi-Tech Peripherals Corp.**, 15192 Triton Lane, Huntington Beach, Calif. 92641, (714) 891-0027. **Circle No 324**

Half-height Winchester stores 10.5M bytes

The CM4000 half-height, 5¼-inch Winchester disk drive stores 10.5M bytes (formatted) using a single platter of standard oxide media. Recording density is 9,275 bpi. The drive also features 750-tpi track density with 640 data cylinders per disk and 1,280 tracks per disk. Data-transfer rate is 5M bits per second; average access time is 75 msec. The drive measures 1.65 by 5.75 by 8 inches, weighs 3 pounds and



consumes 15.5W. Approximately \$600 (OEM quantities). **Computer Memories Inc.**, 9216 Eton Ave., Chatsworth, Calif. 91311, (213) 709-6445. **Circle No 325**

CUSTOM CONTROLLER BOARDS MEET UNIQUE STANDARDS.

Whatever your needs are in a controller board, SMC can meet them. We have the capability to modify our standard board products to your own unique specifications. Since we use the latest VLSI technology, we can usually do it faster, more reliably and at a lower cost than anyone else. In fact, in the last year, we've designed custom boards for the airline, banking and medical instrumentation industries. Now let us show what we can do for you. For complete details, contact Standard Microsystems Corporation, 35 Marcus Boulevard, Hauppauge, NY 11788 (516) 273-3100.

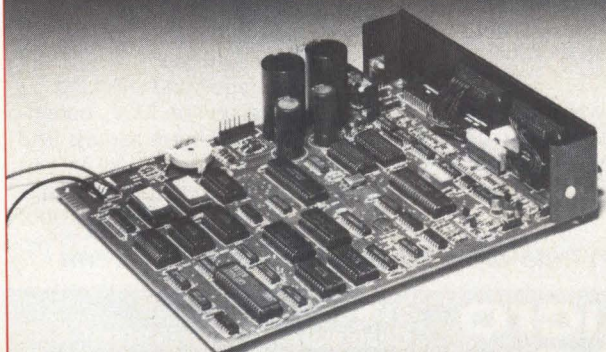

STANDARD MICROSYSTEMS. THE ONE TO WATCH.

CIRCLE NO. 138 ON INQUIRY CARD

IBM 3278/3178 Terminal Users... "ADD-ON" PERSONAL COMPUTING CAPABILITY!

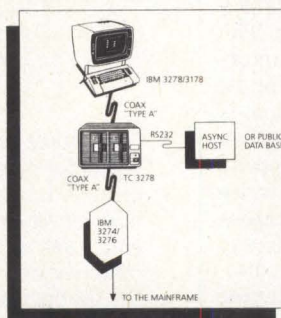

AVATAR's TC3278 terminal converter gives local computing power, communications, data storage and file transfer capabilities to your terminals. And switches between standard terminal operation and local computing with the flick of a switch.

- Includes industry standard software
CP/M and MS-DOS (IBM compatible)
WordStar word processor
Spreadsheet and simple to use utilities
 - Allows dual host access
 - Converts 3278/3178 to VT 100 for async ASCII host, remote hosts, public database access
 - Host file transfer for data sharing and local printing
 - Simple to use, easy to install, requires **NO** modification to terminal
 - **Cost Effective** enhancement to existing equipment
- For more information, call 3R Computers, 18 Lyman Street, Westboro, MA 01581, (617) 366-5300
TWX 710-390-0375.

AVATAR™

© 1983 RRR Computers, Inc.
IBM is a registered trademark of International Business Machines Corp.

CIRCLE NO. 144 ON INQUIRY CARD

New Products

PRINTERS



Dot-matrix printer achieves 500 cps

The DP-6500 data-processing printer achieves speeds of 500 cps at 10 cpi. For 132-column printing, the DP-6500's speed is higher than 200 lpm. Key to the DP-6500's speed is an 18-needle print head consisting of two vertical columns of nine needles each. Other DP-6500 features include selectable ranges of 10, 12, 15 and 16.4 cpi, seven ISO character sets that include Swedish, Danish-Norwegian, German, French, Spanish, Italian and standard USASCII and font down-loading from the host computer. \$2995. **Anadex Inc.**, 9825 De Soto Ave., Chatsworth, Calif. 91311. Phone (213) 998-8010. **Circle No 326**

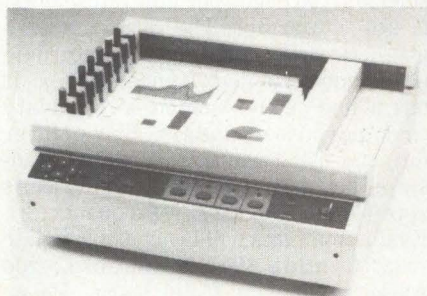

Digital plotter suited for presentation graphics

The model XY/749 eight-pen digital plotter generates vectors, circles and arcs, axes and point-marks with 0.1-mm. resolution. It can also print all 96 ASCII characters at any angle with user control of height, width and slant. Plotting speed is 450 mm. per sec., and printing speed is 3 cps. The plotter is compatible with most mainframes, minicomputers and personal computers. RS232C and IEEE 488 interfaces are available. Prices start at \$1995. **IBM Instruments Inc.**, P.O. Box 332, Danbury, Conn. 06810. Phone (800) 243-7054. **Circle No 327**

Printer line includes high-speed, color models

The enhanced "B," the two-speed "S" and the two-speed/seven-color "SC" are new versions of C. Itoh Electronics' 8510A and 1550A serial dot-matrix printers. The "B" models have addition-

al dip-switch settings of 6 or 8 lines per in., increased throughput of 68 lpm versus 63 lpm and enlarged overrun and receive buffers. The "S" models have a 180-cps draft-quality printing mode as well as the "A" models' standard 120-cps printing speeds. The "SC" models feature 120- and 180-cps printing speeds

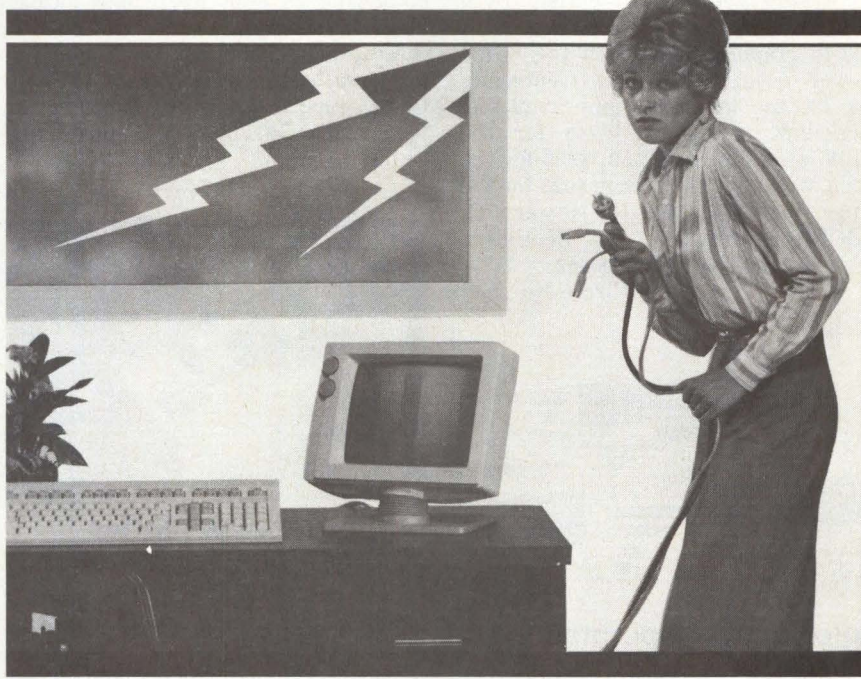

Do lightning storms "pull the plug" on your computer efficiency?

Electrical storms can cause "terminal paranoia" for small computer and word processing operators. And that causes some totally unnecessary work disruptions. A sensible solution is both available and affordable. Check out Liebert environmental control and power protection systems. Call **614/888-0246**.

We help make your computer investment pay off!



Accommodate2



Mini-Mate



World leader in computer support systems.



Mini-Center



Challenger2

Liebert Corporation, 1050 Dearborn Drive,
P.O. Box 29186, Columbus, Ohio 43229,
614/888-0246 Telex: 246655 LIEBERT WOGN

CIRCLE NO. 145 ON INQUIRY CARD

New Products

PRINTERS

and a three-color ribbon that provides users with a seven-color printing palette. The basic difference between the 8510 family of printers and the 1550 family is in carriage width: 8510 models have an 80-character-per-line format for forms 4½ to 10 in. wide, while the 1550's 136-character-per-line format accepts forms 4½ to 15½ in. wide. The 8510 has a standard 1K-byte buffer, and the 1550 has a standard 3K-byte buffer. Both printers have a 9 × 9 matrix and a built-in graphics mode with 144 × 160 dot-per-sq.-in. resolution. Centronics and RS232C interfaces are available. Single-unit prices are \$745 for the 8510B, \$995 for the 1550B, \$825 for the 8510S, \$1225 for the 1550S, \$925 for the 8510SC and \$1325 for the 1550SC. **C. Itoh Electronics Inc.**, 5301 Beethoven St., Los Angeles, Calif. 90066.

Circle No 328

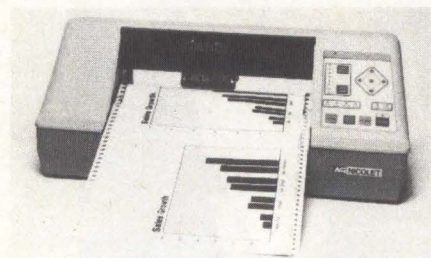

Color plotter operates in SNA/SDLC environment

The Zeta 887, an eight-color pen plotter, connects directly to an IBM 3274 or 3276 cluster controller providing high-resolution, hard-copy output directly from an IBM 3274 or 3276. Plotting speed is 20 ips. Various media types (translucent bond, glossy bond, vellum or clear inking film) and media widths (ISO A3, A4 and ANSI A, B size drawings) are supported. The commands required to drive the Zeta 887 can be generated by any application program that uses industry-standard plotting routines. The plotter is also supported by ISSCO's DISSPLA and TELL-A-GRAF, Precision Visuals, DI3000 and the SAS/GRAPH software packages. \$7950. **Nicolet Zeta Corp.**, P.O. Box 4003, Concord, Calif. 94524. Phone (415) 671-0600.

Circle No 329

Color printer produces more than 4900 hues

The TC1040 color ink-jet printer/plotter can produce 4913 hues on

various pin-fed media. Printing resolution is 84 or 120 dpi horizontally and 85 dpi vertically. A maximum of 12.1 in. of printing surface is provided, allowing as many as 1300 individually addressable pixels. Print speed averages 27 ips, and the average printing time for a 512- × 512-pixel image at 85 dpi is less than 1 min. The TC1040 interfaces via an RS232C or Centronics-type I/O port employing an 8-bit ASCII data format. English, Spanish, German, French, Swedish, Dutch and ASCII character sets are available. \$5495. **PrintaColor Corp.**, 5965 Peachtree Corners E., Norcross, Ga. 30071. Phone (404) 448-2675.

Circle No 330

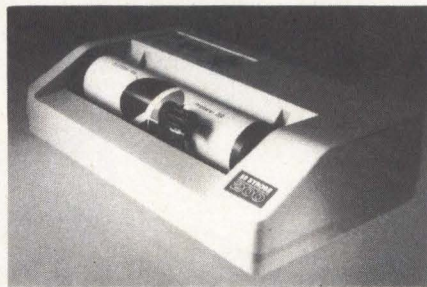

Color graphics plotter changes pens automatically

The model 260 graphics plotter produces plot graphs and charts using as many as six colors with automatic pen changes. The individually replaceable pens are held in a cartridge. Menu-driven software lets users preselect colors before initiating plots and generate bar charts, pie charts and line graphs with a resolution of 500 steps per inch on both the x and y axes. The plotter can also label charts and create text pages. It has an RS232C interface and is compatible with computers that run the CP/M-80, PC-DOS and MS-DOS operating systems. \$995. **Strobe Inc.**, 897-5A Independence Ave., Mountain View, Calif. 94043, (415) 969-5130.

Circle No 331

Matrix line printers operate at 600 lpm

The GE 4030 and GE 4060 shuttle matrix line printers operate at 300 and 600 lpm, respectively. Standard character spacing is 5 cpi, 10 cpi and 13.3 cpi. Line spacing is 6 or 8 lines per in. Both printers have graphics capabilities featuring a resolution of 60 × 72 dpi or 120 × 144 dpi. Both printers use

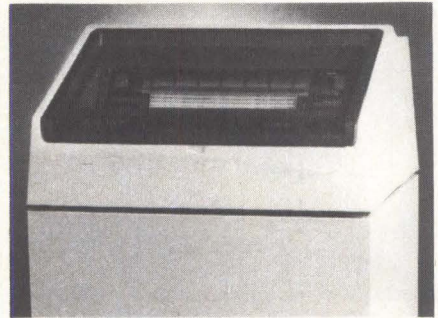

continuous, fanfold, margin-punched paper and can print six-part forms. Full 94-character ASCII sets are standard, with space provided for national character sets or special symbols. Industry-recognized, plug-compatible interfaces are available. Prices range from \$5500 to \$8500 with delivery scheduled for mid-1984. **General Electric Co., Data Communication Products Department**, Waynesboro, Va. 22980. Phone (703) 949-1000.

Circle No 332

Magnetic printer uses perpendicular recording

The MP6090 high-speed magnetic printer for the OEM market prints at 6000 lpm (88 pages per min.) Resolution is 240 × 240 dpi. The printer uses a magnetic drum, perpendicular recording heads and a single-component toner. It has a line-printer emulation capability that permits standard line-printer formats using multiple fonts in landscape and portrait directions. Price is approximately \$25,000 (OEM quantities). Evaluation units will be available in late 1983. **Cynthia Peripheral Corp.**, 766 Aleso, Sunnyvale, Calif. 94086. Phone (408) 745-0855.

Circle No 333

Low-cost thermal printer serves pc systems

The STX-80 thermal printer provides bidirectional logic-seeking printing of 80 characters per line, or 40 cpl in expanded print mode, at 60 cps. It furnishes 96 standard ASCII characters and 51 European characters using a 5-by-9 dot matrix, 64 block graphic characters using a 6-by-6 dot matrix and bit image graphics using an 8-by-480 dot matrix. A standard Centronics-compatible 8-bit parallel interface permits use with most personal computers. The printer employs standard

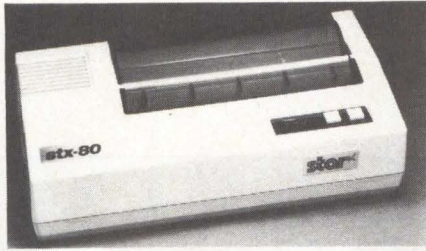

8½-inch-wide, friction-feed, thermal-roll paper. \$200. **Star Micronics Inc.**, 1120 Empire Central Place, Dallas, Texas 75247, (214) 631-8560.

Circle No 334

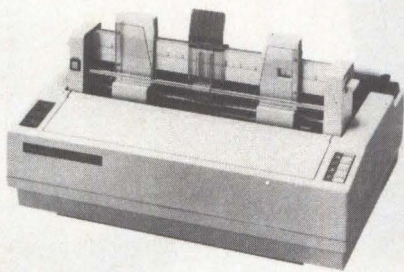

Impact printers offer high speed, graphics

Logic-seeking bidirectional units featuring bit-image graphics, the KX-P1160 and KX-P1090 impact dot-matrix printers provide a seamless cartridge-type ribbon designed for long life and easy replacement. Both models can print 96 standard ASCII characters with true descenders, and the KX-P1090 also offers three international character sets. The 136-column KX-P1160 prints at 165 cps with 9-by-13 resolution and handles fanfold paper 4 to 15 inches wide. The 80-column KX-P1090 prints at 80 cps with 9-by-9 resolution and accommodates fanfold or single sheet paper from 4 to 10 inches wide or 8½-inch-wide roll paper. Each printer offers standard parallel interface and optional RS232C interfaces. KX-P1160: \$1,750, KX-P1090: \$550. **Panasonic Industrial Co.**, 1 Panasonic Way, Secaucus, N.J. 07094, (201) 348-7183.

Circle No 335

Printer provides range of character sizes

The Gemini 10 impact dot-matrix printer provides 100-cps logic-seeking bidirectional printing and true descenders in 17, 12, 10, 8.5, 6 and 5 cpi sizes. Italic, subscript and superscript are available as well as emphasized, double-strike and underline options.

The unit offers 96 standard ASCII characters, 96 italic characters, 64 special characters and 32 block graphic characters using a 6-by-6 dot matrix. Users can program additional characters into 2K bytes of PROM. Both 60-by-72 low-resolution and 120-by-144 high-resolution bit-image graphics are

available. A Centronics-compatible parallel interface is standard, and an RS232/20-mA current-loop serial interface is optional. \$399. **Star Micronics Inc., Computer Peripherals Division**, 1120 Empire Central Place, Dallas, Texas 75247, (214) 631-8560.

Circle No 336



Are your computers getting the "shock treatment"?

Static electricity, humidity and other environmental problems can cause all kinds of annoying disruptions to your computer or word processing work flow. And it's totally unnecessary!

Liebert offers affordable solutions to all small computer environmental and power problems. Call **614/888-0246**.

We help make your computer investment pay off!



Accommodate2



Mini-Mate



World leader in computer support systems.



Mini-Center



Challenger2

Liebert Corporation, 1050 Dearborn Drive,
P.O. Box 29186, Columbus, Ohio 43229,
614/888-0246 Telex: 246655 LIEBERT WOGN

CIRCLE NO. 146 ON INQUIRY CARD

New Products

TERMINALS

DG expands Dasher terminal line

Data General Corp. has introduced four ergonomically designed Dasher terminals. The D210 and D211 are low-cost replacements for the Dasher D200 terminal, while the D410 and D460 terminals feature higher functionality including windowing and screen-management capabilities. The D460 also offers graphics capabilities intermixed with alphanumeric text. The terminals are compatible with earlier Dasher models and can be used with existing applications.

Each terminal has a 12-inch tiltable display housing and a low-profile keyboard. The D410/460 displays 24 lines of 81 columns in a 10-by-12 dot matrix or 135 columns in a 12-by-12 dot matrix. Users can define as many as 24 windows. Bidirectional vertical scrolling and 162-column horizontal scrolling are available.

The terminals support a complete set of editing commands including erase screen, window, unprotected text, end of line, insert/delete character, line, margin commands and change attributes.

The D410/460 Dasher family provides 512 pre-defined characters including 95 ASCII, 68 foreign-language characters, a subset of the Greek alphabet, extended math symbols, forms ruling, word-processing symbols, superscripts and subscripts. D460 users can also define as many as 3,752 additional characters that can be down-line loaded from the host computer.

Conversational terminal shows 128 characters

The model ADM 11 video display terminal comprises a 12-inch, non-glare green screen with tilt-and-swivel adjustments and a detachable, low-profile keyboard with Selectric-type layout, a numeric keypad, a tilt mechanism and three-key rollover. The screen can display 128 characters including control codes, block graphics, wide-point graphics and line-drawing characters in an 80-column-by-24-line format. Other highlights include non-embedded reduced intensity, blink, blank and

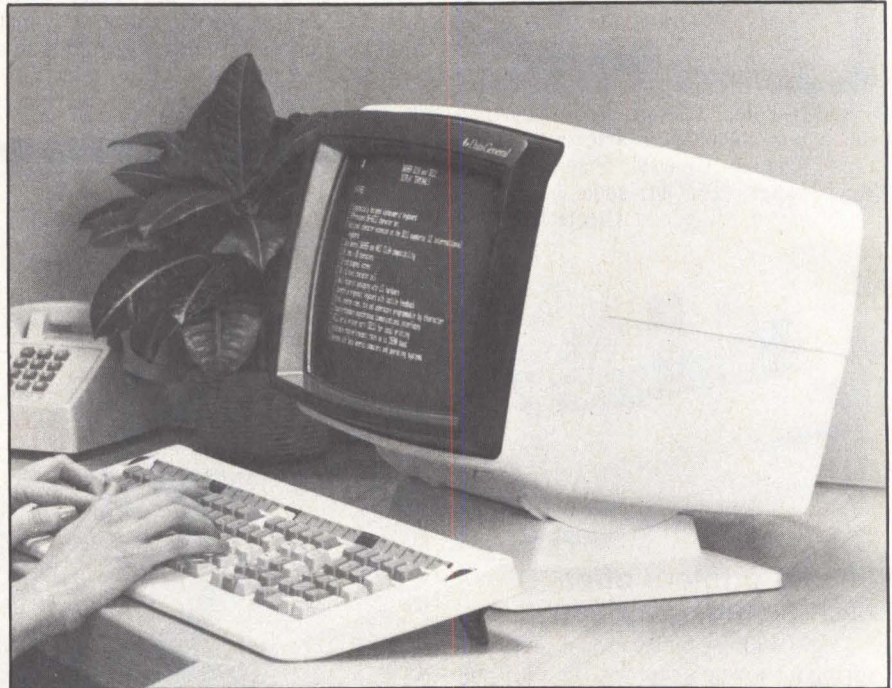

DG's new Dasher terminals are designed for use with Eclipse, Nova and CS small-business systems.

The terminals support ANSI command formats X3.41/X3.54, DG command codes, 20-mA current loop (except the D210) and RS232C interfaces and local printing. The terminals are supported by the AOS, AOS/VS and AOS/RT32 operating systems as well as DG's CEO (comprehensive electronic office) and systems software. The D210 and D211

models are also supported by the DOS, RDOS, RTOS, MP/OSO and MP/AOS operating systems.

Prices range from \$995 for the D210 to \$1,785 for the D460. Delivery is 60 days. **Data General Corp., Information Systems Division**, 440 Computer Dr., Westboro, Mass. 01581, (617) 366-8911. **Circle No 337**



reverse video, line and page erase, two non-volatile setup modes, four print modes and four programmable and optionally non-volatile function keys. \$695. **Lear Siegler Inc., Data Products**

Division, 714 N. Brookhurst St., Anaheim, Calif. 92803, (714) 774-1010. **Circle No 338**

Ergonomic terminal is IBM plug-compatible

C. Itoh Electronics' CIE-7800 video display terminal is plug-compatible with IBM 3278 and 3178 terminals. It has a tiltable 14-inch, non-glare green or amber screen, a 12-inch-by-12-inch footprint and an 87-key keyboard. The terminal displays 12 to 43 lines of 80



characters or 27 lines of 132 characters. Standard character sets are EBCDIC and ASCII. Other features include a printer interface and a bi-level, software-activated security lock. Concurrent alternate personalities such as DEC VT100, Burroughs TD 830/983/986, IBM 3101-3104 and IBM 3275/76-2 (bisynchronous) are available. Contact the vendor for price information. **ACM Inc.**, Suite 540, 3857 Birch St., Newport Beach, Calif. 92660, (800) 854-5959.

Circle No 339

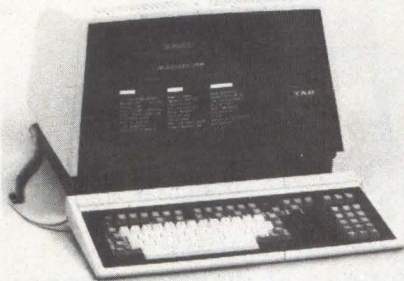

Terminal operates in three modes

The model 132/15H Honeywell-compatible smart terminal operates in one of three standard operational modes—character, text or form. The terminal has an internal clock, and provides keyboard-selectable asynchronous and synchronous communications rates. Its 15-inch non-glare screen displays 80 or 132 columns. In addition to 95 ASCII keys (including 11 Honeywell business graphics characters), a 14-key numeric pad and 26 control keys, the 132/15H has 14 user-programmable function keys. \$2,200. **Tab Products Co.**, 1451 California Ave., Palo Alto, Calif. 94304, (415) 858-2500.

Circle No 340

Terminal suits graphics applications

Intended for graphics applications, the J-1014 monochromatic, microprocessor-based terminal features 1024-by-780 resolution, an 880-nsec.-per-dot draw-

ing rate and compatibility with Tektronix 4010 and 4014 commands and with DEC VT100 terminals. The terminal can run many software packages including Plot 10. The J-1014 performs scrolling and selective-erase functions and can generate circles and multiple line styles.



Did your computer pull the old "disappearing data" trick again?

Humidity or "dirty" electrical power can cause all kinds of costly, annoying disruptions to your work flow and productivity. Liebert offers low cost solutions to small system environmental and power problems. Stop wasting work and "missing messages." Call **614/888-0246**.

We help make your computer investment pay off!



Accommodate2



Mini-Mate



World leader in computer support systems.

Liebert Corporation, 1050 Dearborn Drive,
P.O. Box 29186, Columbus, Ohio 43229,
614/888-0246 Telex: 246655 LIEBERT WOGN



Mini-Center



Challenger2

New Products

TERMINALS

A color version is available. \$3,995. Delivery is 60 days. **KEL Inc.**, 1 World Trade Center, Suite 4811, New York, N.Y. 10048, (212) 524-8350.

Circle No 341

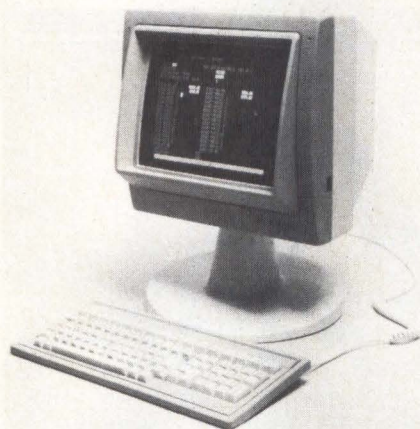

Display terminal exhibits ergonomic design

The model C-300 microprocessor-controlled, conversational video display terminal features a movable keyboard and a 14-inch screen that displays green characters on a black background in an 80-column-by-24-line format. Shielded on four sides, the screen can tilt and swivel. Five video attributes—normal, reverse, blink, half-intensity and security (no display)—are selectable. A portion of the display can be protected, while an operator enters or receives data in the unprotected portion. An RS423 interface is standard. \$1,495. **Cado Systems Corp.**, 2055 W. 190th St., Torrance, Calif. 90504, (213) 323-8170.

Circle No 342

Terminal addresses block-mode applications

Compatible with DEC VT100 units, the ATL-004 microprocessor-based, buffered display terminal operates in conversational or block modes. It features a 14-inch screen, a 9-by-13 character cell, 80- and 132-column display formats, 27 display lines, programmable smooth scrolling and eight soft function keys. Applications include message communications, forms-oriented data entry, inquiry/retrieval, transaction process-

ing, distributed data processing and system and process control. \$995. **Beehive International**, 4910 Amelia Earhart Dr., Box 25668, Salt Lake City, Utah 84125, (801) 355-6000.

Circle No 343

DEC-compatible terminal features English setup

The Excel 60 Plus DEC VT131-/132-compatible display terminal features English-prompted setup menus, 15 programmable function keys and a printer port for DEC and non-DEC



printers and video capabilities such as reverse video, underlining and bold and blinking characters. The terminal displays 24 lines of 80 or 132 characters with reverse, underlined, bold or blinking attributes. It operates in character and block transmission modes. A bidirectional RS232C port is standard. A choice of 12- or 14-inch monitors with green, gray or amber phosphors is offered. \$1,250. **Data-media Corp.**, 7401 Central Highway, Pennsauken, N.J. 08109, (609) 665-5400.

Circle No 344

Terminal displays 132 columns

Tailored for business applications, the Altos II smart terminal contains a 14-inch tiltable screen with an 80- or 132-column display and smooth vertical scrolling. It also offers horizontal and vertical split screens, three character sizes and six hidden attributes. The terminal's detachable keyboard has an 18-key numeric keypad whose keys can double as special-function keys. Other



features include DEC VT100 emulation, 16 programmable function keys, two pages of memory, four communications modes (full and half duplex, local and block) and power on self test. \$1,195. **Altos Computer Systems**, 2641 Orchard Parkway, San Jose, Calif. 95134, (408) 946-6700.

Circle No 345

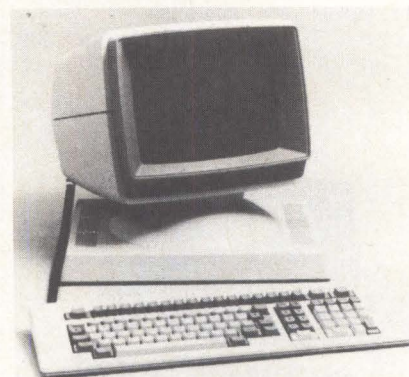

Terminal features 48 lines of display memory

The model ADM 24E video display terminal has a low-profile, tilt-adjustable, detached keyboard and a 12-inch, non-glare green CRT monitor contained in a tilt-and-swivel adjustable housing. The 80-column terminal provides a standard 48-line display memory with a 24-line scan. Non-embedded visual attributes include reverse video, reduced intensity, underline, blink, blank and double-width characters and business graphics. Standard features encompass 16 programmable function keys, selectable international character sets, non-volatile terminal setup from the keyboard and full editing functions. \$1,250. **Lear Siegler Inc./Data Products Division**, 714 N. Brookhurst St., Anaheim, Calif. 92803, (714) 774-1010.

Circle No 346

New Products

DATACOMM

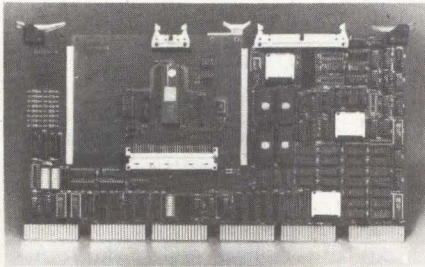

Unibus controller connects computers to Ethernet

The Easyway Ethernet port controller connects PDP-11 and VAX computer systems to an Ethernet network. The board supports layers 1 through 4 of the network architecture. A companion product, Connect software, handles the session level, layer 5. Easyway combines two modules on a single hex-width board. The host protocol processor contains the Unibus interface and the transport protocols. The communications adapter board plug-in module provides the link and the physical protocol to the Ethernet network. A transceiver interface cable connects to the user-supplied transceiver cable. Easyway can be installed in any hex-width slot in a DDLL Unibus backplane configured for DMA operation. It meets Xerox/Intel/DEC Ethernet specification 1.0 and supports a 10M-bit-per-second data rate. \$5,000. **Able Computer**, 1732 Reynolds Ave., Irvine, Calif. 92714, (714) 979-7030.

Circle No 347

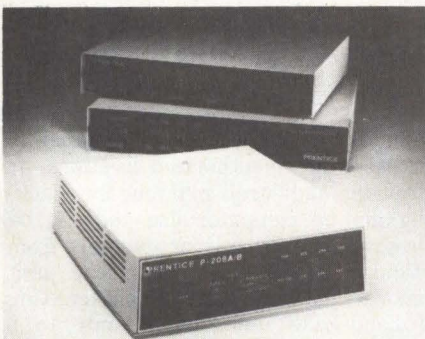

Standalone modem operates at 4,800 bps

The P-208A/B 4,800-bps synchronous modem is Bell 208A and 208B compatible. It operates in half-duplex mode over public switched telephone networks and two-wire leased circuits and in full-duplex mode over four-wire leased circuits. This auto-answer,

direct-connect modem features automatic adaptive equalization. Transmission levels and timing are strap selectable. Remote and local analog and digital loopback tests can be monitored from front-panel indicators. \$1,750. **Prentice Corp.**, 266 Caspian Dr., P.O. Box 3544, Sunnyvale, Calif. 94088, (408) 734-9810.

Circle No 348

Multiport modem reduces telephone-line requirements

The Micro4000 model 4096/4+ multiport modem combines a time division multiplexer with a 9,600-bps modem in a compact package to support as many as four synchronous terminals or channels on one unconditioned telephone line. As many as four input channels operating at 2,400, 4,800, 7,200 or 9,600 bps can be supported as long as the aggregate composite data rate does not exceed 9,600 bps. The modem complies with CCITT Recommendation V.29 and features down-line channel loading and composite link parameters (such as operating speed), front-panel status indicators, independent local and remote loop-back tests for the selected channel or the composite link and individual channel buffering and control signal passing for linking to other communications equipment. \$3,695. **Micom Systems Inc.**, 20151 Nordhoff St., Chatsworth, Calif. 91311, (213) 998-8844.

Circle No 349

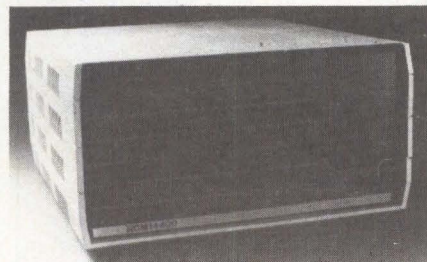

Modem multiplexes six data channels

The NCM14400 modem consolidates data traffic from multiple medium-speed lines, multiplexing as many as six data channels on a single circuit and supporting 11 data-rate/channel combinations. It operates at 14,400 bps over domestic and international private lines

and offers 12,000- or 9,600-bps fallback speeds. An all-digital automatic/adaptive equalizer senses the characteristics of a given telephone line and automatically trains itself to compensate for amplitude and delay distortion introduced by the channel. Initialization time is 225 msec. Other features include a 150-bps side channel and dial backup. \$7,650. **Intertel Inc.**, 6 Shattuck Rd., Andover, Mass. 01810, (617) 681-0600.

Circle No 350



Modem features remote-boot capability

The BytCom 212AD is a Bell 212A-compatible modem with a micro-processor-based auto-dial circuit. The modem provides 0 to 300-baud and 1,200-baud transmission over the switched telephone network. The modem can store as many as nine phone numbers and associated names in non-volatile memory. Other features include remote-boot capability, software disconnect, a 16-character answer-back capability and an integral voice/data switch. Tone, pulse and blind dialing are interchangeable within a stored-number sequence to allow users on pulse circuits to dial over MCI and Sprint lines. \$695. **BytCom**, 2169 Francisco Blvd., Suite H, San Rafael, Calif. 94901, (415) 485-0700.

Circle No 351

Answer-only modem operates in three modes

The DSM/Triple rack-mounted modem automatically responds to Bell 212A-, Bell 103- and Vadic VA3400-originating modems. This answer-only unit handles serial binary data at low synchronous (1,200 bps) and asynchronous (0- to 300- and 1,200-bps) speeds. Character lengths run from 8 to 11 bits, depending on the mode. A modem-detect algorithm determines the type of modem originat-

New Products

DATACOMM

ing the call and automatically switches the unit into the compatible mode. Diagnostics include local and end-to-end tests as well as analog and digital loopbacks. \$850. **Infotron Systems Corp.**, Cherry Hill Industrial Center, Cherry Hill, N.J. 08003, (609) 424-9400.

Circle No 352

Modem for IBM PC has asynch communications

The Signalman Mark VI modem for the IBM Personal Computer features a data-transmission rate of 300 baud, Bell 103 compatibility, tone and pulse dialing and auto-answer/auto-dial programmability. The Mark VI connects directly to

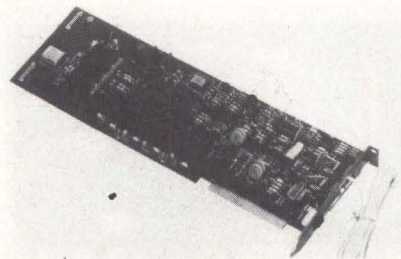

a modular telephone wall jack. It fits directly into any of the PC's expansion slots and eliminates the need for an asynchronous communications card. The AnComm communications program provided with the Mark VI allows a user to send and receive text files, provides an automatic text-capture buffer, stores a directory of frequently dialed telephone numbers and allows single-key dialing of phone numbers in the directory and unattended answering. \$279 including a subscription to the Source. **Anchor Automation Inc.**, 6624 Valjean Ave., Van Nuys, Calif. 91406, (213) 997-6493.

Circle No 353

Give at the office

... and Quietly enjoy it next year.



Give the gift of quiet to your office work environment. Give QUIETPRINT.

The year end is nearing. Nothing has changed. Your office is still noisy. And at this time of year employees have so many holiday thoughts that any additional distractions, such as noise, make productive work difficult. It's time for a generous change . . . QUIETPRINT.

A QUIETPRINT Acoustical Cabinet will silence your word processor, data printer or teleprinter. Give your office the quiet it deserves and enjoy the benefits all next year. Not only can the productive quiet be a joy, but you will enjoy a tax break, too! But don't let the office know; your quiet generosity may lose some of its mystery.

With models available for more than 300 business machines your gift selection is assured to be easy. Call us today and we can discuss your needs, or write for a brochure showing our line of quality quiet cabinets.

quietprint
INC.

We're making a lot of noise . . . quietly.

P.O. Box 11067, Santa Rosa, CA 95406
707 527-8180, TELEX 17 6310

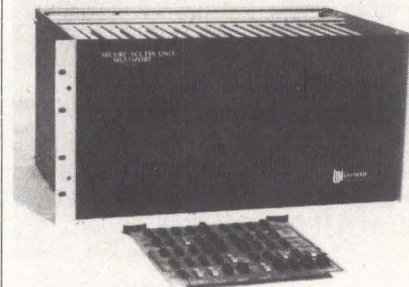

Security device uses call-back to limit access

The Secure Access Multiport (SAM) security device uses programmable memory and call-back to prevent dial-up access from unauthorized locations. It provides audit-trail printout for tracking dial-up computer use and can be programmed directly or remotely from standard ASCII terminals. The unit answers incoming calls without emitting a handshake tone, reacts only to a six-digit location identification number (LIN) and disconnects the call, preventing line tie-up. A programmable LIN directory handles 256 telephone numbers. Unauthorized incoming calls are thwarted, and the intrusion attempt is noted. \$570 to \$1,400 per port. **LeeMAH**, 729 Filbert St., San Francisco, Calif. 94133, (415) 434-3780.

Circle No 354

CIRCLE NO. 148 ON INQUIRY CARD

New Products

SOFTWARE

Language support for DEC, TI computers

Digital Research programming languages are available now through the CP/M Library in disk formats for the DEC Rainbow 100 and TI Professional Computer. The CP/M Library is a set of software packages for popular computers in attractive, uniform packages for retail distribution. Initial languages in the new formats include Pascal/MT+, PL/I, Level II COBOL, CIS COBOL, CBASIC and the CBASIC Compiler. Utilities such as the Speed Programming Package for use with Pascal/MT+, a symbolic instructive debugger and a set of programmers' utilities including a relocating assembler, linkers and a librarian are also available in the new format. Prices range from \$150 for the symbolic instructive debugger to \$1600 for Level II COBOL. **Digital Research Inc.**, P.O. Box 579, 160 Central Ave., Pacific Grove, Calif. 93950. Phone (408) 649-3896. **Circle No 355**

Pascal compiler runs on IBM PC

SBB Pascal is a two-pass, locally optimizing Pascal compiler for the IBM Personal Computer that runs under PC-DOS. A CP/M-86 version is planned. Based on the Pascal/z compiler, SBB Pascal closely follows the Jensen and Wirth definition of the language with extensions designed to aid the professional programmer in software development. Extensions include variable-length strings, direct file access, arbitrary precision BCD numbers for business arithmetic, functions returning structured values, separate compilation, external routines, include files, symbolic I/O of enumeration types, an ELSE clause for the CASE statement, overlays and chaining. The compiler package also includes an interactive Pascal debugger written in SBB Pascal and a screen editor provided in SBB Pascal source. \$350. **Software Building Blocks Inc.**, P.O. Box 119, Ithaca, N.Y. 14851. Phone (607) 272-2807.

Circle No 356

FORTH system runs on MC68000-based micros

IoForth, a FORTH system for MC68000-based microcomputers with disk drives, features a 32-bit parameter

stack and background tasks. The package includes a kernel, an assembler, a FORTH interpreter, a job swapper, 32-bit floating-point operations, virtual-memory capability, first-in-first-out data structures and a screen editor. Disk-file structure and graphics software are optional. Interface to a user's system is through user-supplied subroutines that perform primitive input/output functions such as printing a character on a terminal or reading a sector from disk. All source code except the kernel and the assembler is priced at \$1990; the complete package is priced at \$5000. **Io Inc.**, 1842 W. Grant Rd., Tucson, Ariz. 85745. Phone (602) 792-0969. **Circle No 357**

Program simulates CP/M on VAX-11 computers

With CP/sim, programs written to run under the CP/M operating system on an 8080 microprocessor with 64K bytes of memory can execute on a DEC VAX-11

computer running under the VMS operating system. CP/sim provides conversion between CP/M and VAX file formats. Features include file protection, availability of date/time stamps and use of version numbers. The package includes a utility for exchanging files between a CP/M-formatted disk and the host VAX \$2,400. **Proto Systems**, 1238 Josephine St., Berkeley, Calif. 94703, (415) 525-9340.

Circle No 358

Statistics database works on Apple II

Statpro, a set of integrated statistics, graphics and data-management programs, turns an Apple II, II+, or IIE computer into a menu-driven research and management workstation. With the database component, a user can enter, edit, manipulate, transform, store, copy and print data. Descriptive, regression, analysis of variance, time series and multivariate statistical functions are provided. They enable users to prepare

Hey Printronix!

Want to talk to IBM? UNIVAC? BURROUGHS? Or Anyone Else?

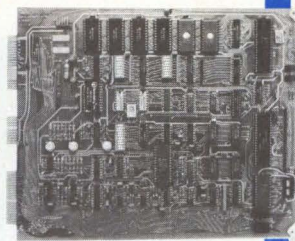

IBM 2770
IBM 2780/3780
IBM 3270
IBM 2946 (PARS)
HASP
UNIVAC DCT 1000
UNIVAC 1004
UNIVAC U-100/U-200/U-400
UNIVAC NTR
Honeywell VIP 7700
Burroughs Poll and Select
NCR Poll and Select

Call Air Land Systems. And find out about our full line of microprocessor-based protocol converters and other data communications interfaces for line printers and other peripherals. We've already developed both hardware and software for most major communications protocols, and we're anxious to discuss your specific needs. For example, our MPC-79 (photo) is specifically designed for PRINTRONIX printers. Some of the currently available protocols are listed at left.



AirLand Systems *A name more OEMs should know!*

2710 Prosperity Avenue • Fairfax, Virginia 22031-4387
(703) 573-1100 TWX: 710-833-1174 AIRLAND FRAX
CIRCLE NO. 149 ON INQUIRY CARD

pma pma pma pma pma

PERIPHERALS MARKETING ASSOCIATION

An Association Dedicated to Addressing the Marketing Concerns of Manufacturers of Computer Peripherals and Related Products.

OVER 20 COMPANIES HAVE JOINED THE NEWLY-FORMED PMA. THEY HAVE RECOGNIZED THAT A TRADE ASSOCIATION CAN BE AN EFFECTIVE TOOL IN RESPONDING TO COMMON MARKETING INTERESTS SUCH AS:

- **INDUSTRY STANDARDS**
- **SALES CHANNELS**
- **TRADE SHOWS**
- **GOVERNMENT REGULATIONS**

IF YOUR COMPANY IS A MANUFACTURER OF DISK DRIVES, TAPE DRIVES, PRINTERS, TERMINALS, CONTROLLERS, AND/OR OTHER PERIPHERAL DEVICES, WE URGE YOU TO JOIN THE PMA. PLEASE USE THE COUPON BELOW TO SEND FOR A MEMBERSHIP APPLICATION AND FOR INFORMATION ON THE TIME AND PLACE OF THE MEMBERSHIP MEETING DURING THE UPCOMING LAS VEGAS COMDEX SHOW.

PMA Members*

Amcodyne Inc.
Longmont, CO
Amlyn Corp.
San Jose, CA
Ball Electronic Systems Division
Broomfield, CO
Beehive International
Salt Lake City, UT
Burr-Brown Data Acquisition and Control Systems Division
Tucson, Ariz.
Cipher Data Products, Inc.
San Diego, CA
Control Data Corp.
Minneapolis, MN
Data Electronics, Inc.
San Diego, CA
Envision
San Jose, CA
Evotek
Fremont, CA
Facit, Inc., Data Products Div.
Nashua, N.H.

International Memories Inc. (IMI)

Cupertino, CA
Omega Corp.
Ogden, UT
Liberty Electronics USA
San Francisco, CA
Mega Vault
Woodland Hills, CA
Micro Peripherals, Inc.
Salt Lake City, UT
Miniscribe Corp.
Longmont, CO
Pertec Peripherals Corp.
Chatsworth, CA
Seagate Technology
Scotts Valley, CA
TEAC Corporation
Montebello, CA
Vermont Research Corp.
North Springfield, VT
Xico Inc.
Santa Monica, CA
Xylogics Inc.
Burlington, MA

*as of July 15, 1983

PMA PRESENTS

"The Importance of Interface Standards"

A panel discussion

A HIGHLIGHT OF THE PMA MEMBERSHIP MEETING DURING THE LAS VEGAS COMDEX SHOW WILL BE A PANEL DISCUSSION ON PERIPHERALS STANDARDS. IT WILL INCLUDE THE FOLLOWING SPEAKERS:

- William Burr, National Bureau of Standards
- Gary Robinson, Digital Equipment Corporation
- Chap Cory, Xylogics
- Dave Kalstron, Seagate Technology
- Larry Hemmerich, Cipher Data Products
- Patrick McMahon, Control Data

PMA
c/o Mini-Micro Systems
221 Columbus Avenue
Boston, MA 02116

PLEASE SEND ME:

- Membership Application Form
- PMA Meeting Information
(to be held during the COMDEX show)

Name _____

Company _____

Street _____

City _____ State _____ Zip _____

SOFTWARE



graphs in scatter, regression, triangle and box plots, as well as pie charts, histograms and dendograms. Users can alter margins, tick marks and color highlights and edit titles, labels and legends. \$1,995. **Wadsworth Electronic Publishing Co.**, 20 Park Plaza, Boston, Mass. 02116, (617) 423-0420.

Circle No 382

Concurrent Pascal suits real-time applications

Intended for programming real-time embedded systems, Micro Concurrent Pascal (mCP) provides process, monitor and class constructs for Concurrent Pascal. A device-monitor construct permits hardware interaction from mCP. The package runs on a host computer that supports sequential Pascal. Compiled output is in P-code or assembly language for Z80, Z8000, 8080/8085, 8086/8088, 6809, 68000 or 1802 target microprocessors or LSI-11 microcomputers. P-code output is re-entrant, relocatable and PROMable. Features include interrupt handling, language constructs for writing device drivers, absolute hardware addressing, separate compilation, and calls to assembly-language routines. Contact the vendor for price information. **Enertec, Inc.**, 19 Jenkins Ave., Lansdale, Pa. 19446, (215) 362-0966.

Circle No 359

GRAPHICS WORKSTATIONS

To the editor:

Concerning "Graphics workstation vendors (MMS, July, Page 174), two items need to be corrected. The listed Aydin Controls system should be spelled AYCON 16, and the resolution range should be 256 by 256 to 1024 by 1024.

Johanna M. Manning
Product Promotion Specialist
Aydin Controls
Fort Washington, Pa.

You've got a PC.

Now where do you put it?



Send today for your free 100-page Inmac catalog.

On a MicroMaster, from Inmac. It eliminates the tangled mess of cables and printout permanently. MicroMaster manages them so your work area stays neatly organized. It's also genuinely portable—with a standard 26½" keying height on sturdy ball-bearing wheels. Best of all, it can be shipped within 24 hours, from the nearest of eight convenient Inmac outlets nationwide. Lifetime warranty, risk-free 45-day trial. \$349. Call toll-free and order a MicroMaster today.

(800) 547-5444.

In Calif. (800) 547-5447.

Inmac Catalog Dept.
2465 Augustine Drive
Santa Clara, CA 95051

Please be sure to indicate your phone number.

Name _____

Company _____

Address _____

City/State/Zip _____

Phone () _____

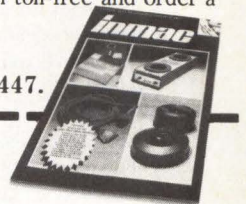

CIRCLE NO. 153 ON INQUIRY CARD

144126

Hey Centronics!

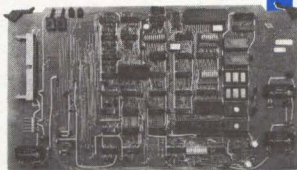
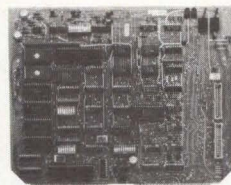

**Want to talk to IBM?
UNIVAC? BURROUGHS?
Or Anyone Else?**

Call Air Land Systems. And find out about our full line of micro-processor-based protocol converters and other data communications interfaces for line printers and other peripherals. We've already developed both hardware and software for most major communications protocols, and we're anxious to discuss your specific needs.

For example, our MPC-81 and MPC-85 (photos at left) are specifically designed for CENTRONICS 6000 and Line-writer printers. Some of the currently available protocols are listed at left.



AirLand Systems A name more OEMs should know!

2710 Prosperity Avenue • Fairfax, Virginia 22031-4387
(703) 573-1100 TWX: 710-833-1174 AIRLAND FRAX
CIRCLE NO. 150 ON INQUIRY CARD

New Products

SUBASSEMBLIES

Array processor offers increased performance

Floating Point Systems Inc. has introduced an advanced series of 38-bit array processors offering as much as 62-million-floating-point-operations-per-second (MFLOPS) performance while reducing the per-MFLOPS price of the average processor to less than \$2,000.

The new FPS-5000 series is expected to replace Floating Point's 100 and 120 series of array processors providing as much as 26 MFLOPS, says Paul Wiley, product line manager for the series. The company expects to ship the processors in February 1984.

The series aims at the signal-image-processing market, including such instrument products as medical imagers, seismic recorders and flight simulators. It encompasses four basic product groups, the 5100, 5200, 5300 and 5400. The basic model, the 5100, sells for \$60,000 and comes with 16K bytes of memory, which can be upgraded to 32K bytes, and has a performance of 26 MFLOPS. At the high end of the line is the 5400, with 32K bytes of program memory, 1M words of data memory and 62-MFLOPS performance. Price of the 5400 is less than \$100,000.

The 5000 series is compatible with interfaces on other 38-bit Floating Point

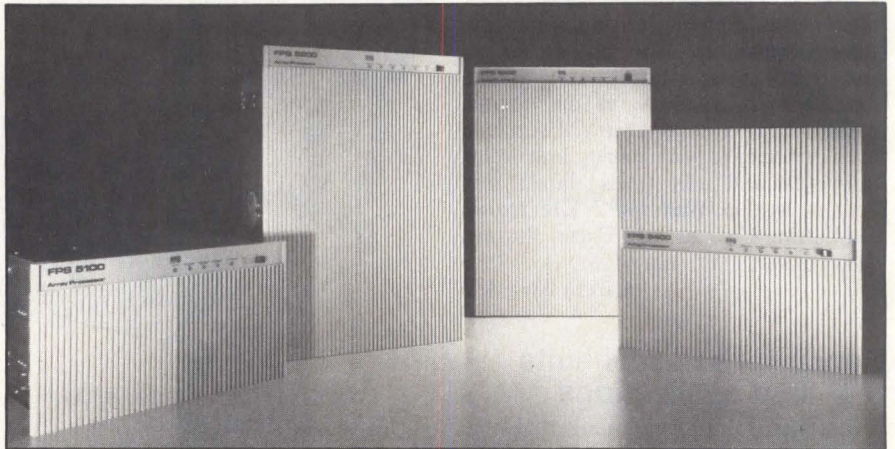

array processors. In addition, it will be software compatible with previous series. The series features a coprocessor with its own local memory and control capability.

The 5200 series has two coprocessors, the 5300 has an optional third coprocessor containing two floating-point adders and a floating-point multiplier with a 6-MHz internal-instruction-cycle time and yielding a 1,024-point complex-fast Fourier transform (FFT) time of 2.7 msec. Independ-

ent local memories and multiple addressing processors in each unit constantly monitor performance.

Floating Point officials expect that, in addition to new installations, older array processors will require servicing, and a large replacement market will develop for the price-competitive new series.

—Robert A. Sehr

Floating Point Systems Inc., P.O. Box 23489, Portland, Ore. 97223, (503) 641-3151. **Circle No 360**

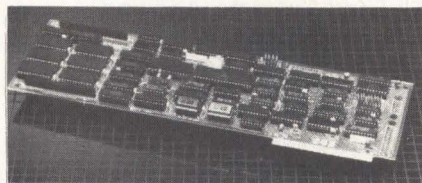

Boards add graphics, CP/M 2.2 to IBM PC

The SuperVision video interface board and the z/Plus Z80 processor board plugs into the IBM Personal Computer. SuperVision allows a user to display 132 columns by as many as 44 rows on a standard IBM PC video monitor. When used with the vendor's graphics adapter, SuperVision generates dot-addressable graphics with 720-by-348-dot resolution. It includes a parallel port that is compatible with IBM's monochrome video board, and the asynchronous communications port can

be configured as COM1 or COM2. The z/Plus board enables the IBM PC to execute CP/M 2.2 or CP/M 3.0 programs and has a 6-MHz Z80B microprocessor, as much as 192K bytes of dual-ported memory and an asynchronous communications interface. Using CP/M 2.2, SuperVision can support 64K bytes of memory; using CP/M 3.0, 192K bytes of memory are available. SuperVision \$720; z/Plus, \$860. **California Computer Systems**, 250 Caribbean Dr., Sunnyvale, Calif. 94086, (408) 734-5811. **Circle No 361**

Optical mouse works with IBM PC software

The PC Mouse works with virtually all software packages on the IBM PC. It allows users to issue as many as nine commands by clicking one of the

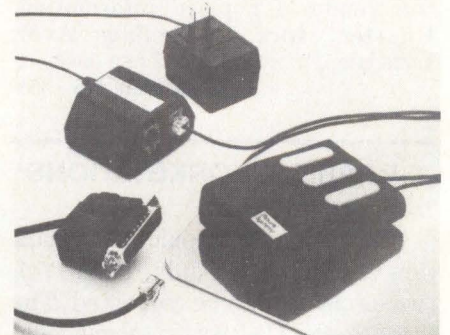

mouse's three buttons one to three times. PC Mouse translates mouse motion and button clicks into user-defined key sequences. As many as 15 key sequences can be assigned to each button code. An internal microprocessor transmits position data at 1200 baud via a three-wire RJ11C connector. An interface box allows direct connection to

an RS232 port. The package also includes the source and executable code for a Draw program with pop-up menus. \$332. **Mouse Systems Corp.**, 2336H Walsh Ave., Santa Clara, Calif. 95051, (408) 988-0211. **Circle No 362**



Color display monitor suits personal computers

The model SC-100 CRT color display monitor is compatible with Apple II, Apple III, Atari 800, Commodore 64, IBM PC, NEC PC, Osborne and TI-99 personal computers. This 13-inch diagonal monitor displays eight colors in a 230-mm. horizontal by 175-mm. vertical area. It features a 40-column-by-24-line format and external front and back controls for sound, contrast, power, vertical hold, color, tint and brightness. The monitor consumes 65W of power and comes in a neutral-colored, polystyrene cabinet. \$329. **Sakata U.S.A. Corp.**, 651 Bonnie Lane, Elk Grove Village, Ill. 60007, (312) 593-3211.

Circle No 363

Plug-in card provides shared database access

A plug-in card for the IBM PC, the Database Machine provides shared database access in multiuser PC networks by incorporating an intelligent LSI hard disk controller and built-in database functions in silicon. The product also features a parallel processor, an 8-MHz Intel 80186 coprocessor, a 64K-byte, triple-ported buffer and 128K bytes of multitask RAM. Only one Database Machine card is required for each hard disk in the PC network. An additional card allows a Database Machine-equipped PC to drive a multiple terminal cluster through the card's serial I/O ports. The product supports as

many as 128 users and is compatible with ST-506 Winchester disk drives and the Omninet, PCnet, Etherlink, Plan 4000 and Sharenet local-area networks. \$1,300 to \$1,500. **Cogent Data Technologies Inc.**, P.O. Box 3902, Bellevue, Wash. 98009, (206) 455-3343.

Circle No 364

Controller supports eight asynchronous lines

Designed for use in Multibus systems, the UB2012 multiline asynchronous controller supports as many as eight asynchronous terminals or lines. It controls all character-by-character processing done by the host CPU in most UNIX systems. The device includes a National Semiconductor NS16008 microprocessor, 64K bytes of buffer memory, 16K bytes of PROM and eight full-duplex lines with programmable baud rates as high as 38,400 bps. The product provides an RS232C or RS422 interface

by a rack-mount panel and connectors. UB2012 AMAC, \$1,995; RS232 interface panel, \$210; RS422 interface panel, \$240. **Unidot Inc.**, 602 Park Point Dr. Suite 231, Golden, Colo. 80401, (303) 526-9263. **Circle No 365**

OCR scanners serve single-application market

The three models in the AlphaWord Series 80 family of optical-character-recognition page readers offer a selection of scanning speeds and a variety of resident type styles such as Courier 10, Courier 12, Prestige elite, Prestige pica, Letter gothic and OCR-B. Models A and B scan 145 pages per hour; model C scans 250 pages per hour. One resident font is standard in all three models, and two optional fonts can be supplied for models B and C. Each scanner supports one RS232-compatible, asynchronous or synchronous interface. They have a control panel, a numeric

Hey Dataproducts!

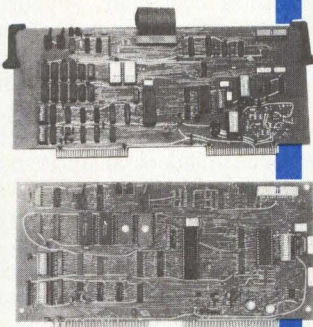

Want to talk to IBM? UNIVAC? BURROUGHS? Or Anyone Else?

Call Air Land Systems. And find out about our full line of microprocessor-based protocol converters and other data communications interfaces for line printers and other peripherals. We've already developed both hardware and software for most major communications protocols, and we're anxious to discuss your specific needs.

For example, our MPC-51 and MPC-73 (photos at left) are specifically designed for DATA-PRODUCTS B300/B600 and M200 printers. Some of the currently available protocols are listed at left.

IBM 2770
IBM 2780/3780
IBM 3270
IBM 2946 (PARS)
HASP
UNIVAC DCT 1000
UNIVAC 1004
UNIVAC U-100/U-200/U-400
UNIVAC NTR
Honeywell VIP 7700
Burroughs Poll and Select
NCR Poll and Select



AirLand Systems *A name more OEMs should know!*

2710 Prosperity Avenue • Fairfax, Virginia 22031-4387
(703) 573-1100 TWX: 710-833-1174 AIRLAND FRAX
CIRCLE NO. 151 ON INQUIRY CARD

New Products

SUBASSEMBLIES

keypad and a 16-character LCD for altering the scannable area of documents that contain unscannable letterhead or embedded graphics. \$12,990 to \$14,990. Delivery is 45 days after receipt of order. **CompuScan Inc.**, 81 Two Bridges Rd., Fairfield, N.J. 07006, (201) 575-500. **Circle No 366**

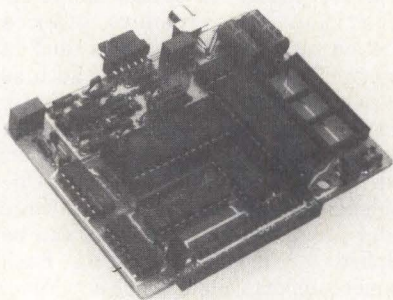

Module produces natural-sounding speech

Compatible with all 8- and 16-bit systems equipped with expansion sockets, the GDX-SPEECH-TI speech-synthesizer module generates a natural-sounding voice using a standard, on-board 206-word industrial vocabulary. An additional on-board vocabulary socket or unlimited speech using CPU-provided LPC-10 data expands the applications. The self-contained module features on-board LPF, 2W audio amplifier, phone jack and volume control. It accepts an 8-ohm speaker and external volume control. The module can also mix low-level audio from an external source with synthesized speech before passing through the internal amplifier. \$285. **General Digital Corp.**, 700 Burnside Ave., E. Hartford, Conn. 06108, (203) 528-9041. **Circle No 367**

Control unit establishes IEEE-488 bus

The model 4835 bus controller makes the RS232 or RS422 serial data port of a computer appear and function as an IEEE-488 bus controller. Connected into the serial link between a central computer and a terminal, the 4835 establishes an IEEE-488 bus wherever situated along the serial link. Software control of the IEEE-488 bus established

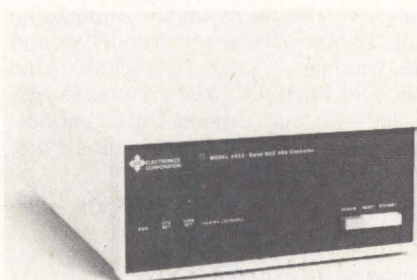

by the 4835 resides in the central computer, allowing a user to write control programs in the language used by the central computer. This stand-alone controller is independent of the central computer's architecture, software operating system and language. \$1,450. Delivery is 45 days after receipt of order. **ICS Electronics Corp.**, 1620 Zanker Rd., San Jose, Calif. 95112, (408) 298-4844. **Circle No 368**

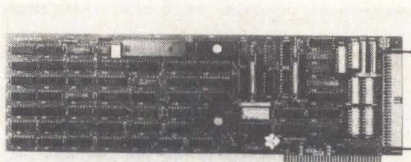

Controller supports SMD interface

The Maverick SMD PC-80, a high-capacity disk controller, supports the SMD disk interface on personal computers. The controller connects as many as two fixed and/or removable SMD disk drives, with capacities ranging from 16M to 800M bytes for each drive, to any IBM PC or IBM PC look-alike. It supports dual porting and programmable sector sizes as large as 960 bytes. It provides automatic error correction with 32-bit ECC, bad-track and -sector replacement and overlapped seeks. Using a buffered architecture with a bipolar state machine managing the data stream, the controller accommodates disk data rates as high as 20M bits per second. A CMOS processor external to the data stream regulates on-board activity. Transfer across the bus can be supported through DMA or programmed I/O. The unit occupies a single slot in the PC and can be installed without modification to hardware. Software drivers are available for MS-DOS 2.0 and UNETix. \$1,200 (100 units). **Interphase Corp.**, 2925 Merrel Rd., Dallas, Texas 75229, (214) 350-9000. **Circle No 369**

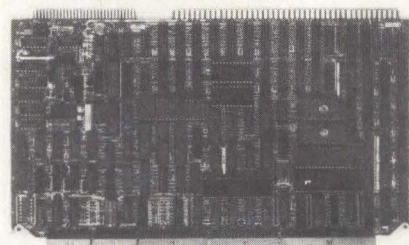

Controller supports file-oriented tape backup

The X217 family of three multifunction Multibus controller boards allows file-oriented transfers and image backup using a QIC-02-compatible ¼-inch streaming tape. Each board occupies only one Multibus card slot. Model 5217 handles two ST-506-type 5¼-inch floppy disk drives and one ¼-inch tape drive. Model 7217 handles two SA1000-type 8-inch Winchester disk drives, two SA800-/SA850-type 8-inch floppy disk drives and one ¼-inch tape drive. Model 6217 interfaces to two 5¼-inch Winchester disk drives, two 8-inch floppy disk drives and one ¼-inch tape drive. These boards feature non-interleaved data transfer, on-board data separation, 32-bit error-correction code and self diagnostics. They incorporate micro-code command primitives that emulate the streaming-tape subset of Intel's ISBX 217 controller. \$1,020 (100 units). **Data Systems Design Inc.**, 2241 Lundy Ave., San Jose, Calif. 95128, (408) 946-5800. **Circle No 370**

Display controller features 1,280-by-1,024 resolution

The Ω500 display controller supports 1,280-by-1,024-pixel screen resolution and provides a 60-Hz non-interlaced refresh rate. Its bit-slice processor, with a 167-nsec. cycle time, can display random vectors at 1.5 million pixels per second and can flash-fill rectangles at 35 million pixels per second. An eight-by-24-color lookup table allows display of 256 colors from a palette of more than 16 million. For applications requiring more depth of color than resolution, the Ω500 is available in a 640-by-512-by-32 folded configuration also capable of 60-Hz operation. In this mode, a software-settable crossbar switch allows a user to configure bit-plane use of the color lookup table. The unit comes with an

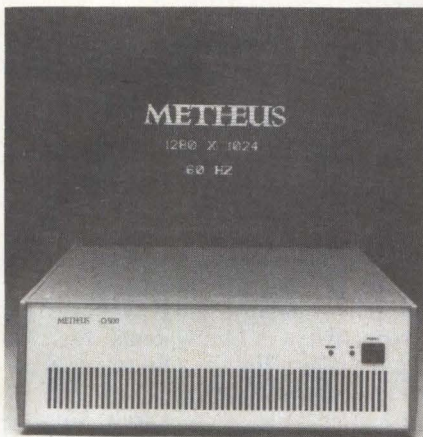

RS232C or a GPIB tablet and DEC or HP 16-bit parallel host communications interface options. \$16,950. **Metheus Corp.**, P.O. Box 1049, Hillsboro, Ore. 97123, (503) 640-8000.

Circle No 371

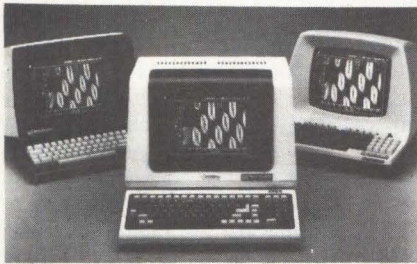

Enhancements emulate Tektronix 4010, 4014

The 512-Series Retro-Graphics, a line of bit-map graphics upgrade products, provides Tektronix 4010 and 4014 graphics terminal emulation and Tektronix Plot 10 graphics software compatibility on TeleVideo, ADDS and Lear Siegler terminals. Based on 4010/4014 protocol, the units provide business, scientific and engineering users with incremental point plotting, multistyle vector drawing (dotted, dashed and solid), four graphics character sets, selective erase and cross-hair cursor capabilities. In addition, special function keys can clear the screen or enter various function modes. The models are compatible with such applications and utility graphics software programs as DISSPLA, TELLGRAFI, Plot 10, Template, DI-3000, SAS/GRAF and ILS. \$749. **Digital Engineering**, 630 Bercut Dr., Sacramento, Calif. 95814, (916) 447-7600.

Circle No 372



SONEX kills disk drive hum.

SONEX acoustical foam's absorption coefficient is four times that of conventional materials. Send for the tests, charts, specs, and color examples from 3800 Washington Ave. N., Minneapolis, MN 55412, or call 612/521-3555.

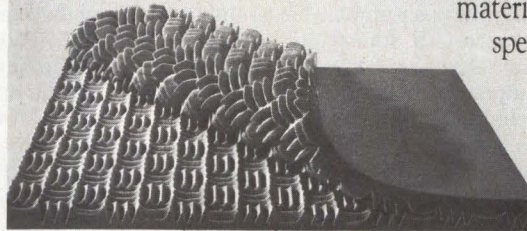

illbruck/usa
techniques with foams

CIRCLE NO. 154 ON INQUIRY CARD

Hey General Electric!*

**Want to talk to IBM?
UNIVAC? BURROUGHS?
Or Anyone Else?**

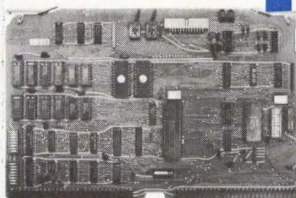

IBM 2770
IBM 2780/3780
IBM 3270
IBM 2946 (PARS)
HASP
UNIVAC DCT 1000
UNIVAC 1004
UNIVAC U-100/U-200/U-400
UNIVAC NTR
Honeywell VIP 7700
Burroughs Poll and Select
NCR Poll and Select

Call Air Land Systems. And find out about our full line of micro-processor-based protocol converters and other data communications interfaces for line printers and other peripherals. We've already developed both hardware and software for most major communications protocols, and we're anxious to discuss your specific needs.

For example, our MPC-29 and PCU-62 (photos at left) are specifically designed for GE 200 and 3000 printers. Some of the currently available protocols are listed at left.

* GE Data Communications Products recently acquired by Genicom Corp.

AirLand Systems A name more OEMs should know!

2710 Prosperity Avenue • Fairfax, Virginia 22031-4387
(703) 573-1100 TWX: 710-833-1174 AIRLAND FRAX
CIRCLE NO. 152 ON INQUIRY CARD

New Products

LITERATURE



Brochure summarizes product line

This product summary brochure covers the vendor's line of communications, disk and tape controllers for DEC computer systems. It provides company background information and technical descriptions with product photos. The listed products feature microprocessor-based architecture, allowing configuration/reconfiguration to standard or custom peripheral requirements by setting on-board switches or replacing microcode PROMS. **Emulex Corp.**, P.O. Box 6725, 3545 Harbor Blvd., Costa Mesa, Calif. 92626, (714) 662-5600 or (800) 854-7112.

Circle No 373

Data sheet details silent ink-jet printer

A six-page, fold-out data sheet outlines the standard features, printing technique, unit weight, dimensions and technical data of the model 2712 silent ink-jet printer. This non-impact printer outputs data and graphics at 270 cps. **Siemens Communications Systems Inc., Office Terminals Division**, 186 Wood Ave. S., Iselin, N.J. 08830, (201) 321-3400.

Circle No 374

Telephone directory lists industry numbers

This directory provides telephone numbers of manufacturers and distributors of computers and peripheral equipment. The directory lists the companies alphabetically and by product category. \$35. **EITD, Harris Publishing Co.**, 2057-2 Aurora Rd., Twinsburg, Ohio 44087, (216) 425-9143.

Circle No 375

Study documents corporate practices

"Management Assessment of User-Driven Technologies," a 122-page study, describes the results of a recent survey of 71 major corporations on their use of personal computers, information centers and fourth-generation technologies. \$90. **FTP**, 492 Old Town Rd., Port Jefferson Station, N.Y. 11776. Phone (516) 473-1110.

Circle No 376

Brochure presents terminal, traffic concentrator

The Dynapac Multi-Pad (packet assembler/disassembler) is described in a four-page brochure. The Multi-Pad concentrates terminal traffic onto an X.25 link, providing access to public or private packet switched networks. As many as 16 asynchronous devices can be supported, and each port can handle a different speed and parity. **Dynatech Packet Technology Inc.**, 6464-G General Green Way, Alexandria, Va. 22312, (703) 642-9391.

Circle No 377

Brochure describes PC-to-mainframe link

VisiAnswer and Answer/DB, two cooperating software products that provide an intelligent connection between personal computers and large databases on IBM mainframe computers, are described in an illustrated, six-page brochure. The brochure describes how the two products bring computing power and central databases to users of VisiCalc and other Visi series packages. VisiAnswer runs on the IBM PC; Answer/DB operates on an IBM mainframe. **Informatics General Corp.**, P.O. Box 1452, Canoga Park, Calif. 91304, (213) 716-1616.

Circle No 378

Brochure highlights 1/4-inch tape drive

A six-page color brochure highlights the Qic-Stor Mark II 1/4-inch streaming-tape drive's operation and design, including tape-edge sensing, self-locking cartridge mechanism, QIC-02/04 compatibility, 20M- to 60M-byte storage capacity and broad applications. **Tandberg Data Inc., Data Storage Division**, 571 N. Poplar, Suite H, Orange, Calif. 92668, (714) 978-6771.

Circle No 379

Brochure outlines graphics systems

A six-page, color brochure details features and benefits of the VIA Series 100 family of interactive graphics systems. The brochure discusses systems hardware, graphics software—including logic and schematic capture and design verification for gate arrays and standard cells—distributed communications, pattern generation, user support, design aids and system productivity. **VIA Systems Inc.**, 76 Treble Cove Rd., N. Billerica, Mass. 01862, (617) 667-8574.

Circle No 380

Micro software directory profiles distributors

Micro Software Distributors: A Sourcebook for Publishers Seeking New Markets focuses on middlemen. Edited by Richard Loftin, it contains profiles of 167 companies seeking programs for resale. Full-page listings describe the companies, the software they seek, how much they pay, the marketing rights they obtain, to whom they sell and the support they provide. The directory covers hardware and software manufacturers and distributors, publishers, retailers and those that license or purchase software for quantity resale. \$95. **Software Research Co.**, Drawer N, P.O. Box 9524, Washington, D.C. 20016, (202) 364-8700.

Circle No 381

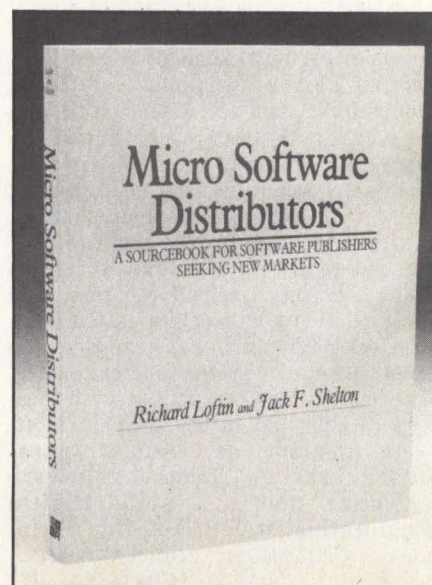

Mini-Micro MARKETPLACE

A special section for advertisers of hardware, software and services.

READERS: Please circle reader service numbers for additional information.

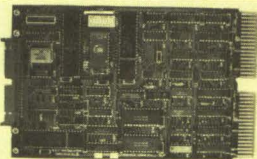

TDL-11SA HOST ADAPTER INTERFACES SCSI/SASI CONTROLLERS TO THE DEC LSI-11 BUS

The TDL-11SA is a dual-wide Host Adapter that interfaces SCSI (SASI) disk controllers to the LSI-11 bus.

The TDL-11SA emulates DEC controllers with RL01/02 disk drives and is fully compatible with DEC operating systems. It features 18 or 22 bit addressing, multiple sector buffering, transparent flow mapping, and a set of built-in self-tests and drive tests. The unit price, including cable, is \$450.

Also available: the TDL-11WD interfaces Western Digital disk controllers to the LSI-11 bus.

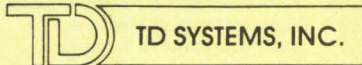

7 WILLIAM ST., MEDFORD, MA. 02155
(617) 391-4166

*DEC is a registered trademark of the Digital Equipment Corp.

CIRCLE NO. 200 ON INQUIRY CARD

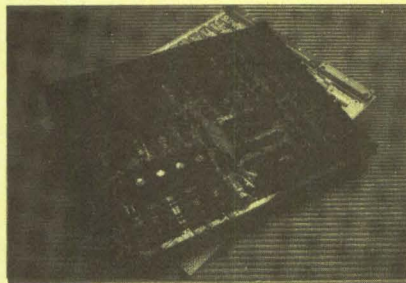

DISK CONTROLLERS WITH CACHE AND HIGH PERFORMANCE FILE MANAGEMENT

The PM-3XXX Disk Controller family contains a powerful, ROM based file management system allowing the host computer to manage real-time tasks while the PM-3XXX handles the disk file management. 32 Kbyte cache improves disk I/O throughput by up to 600%. Wini or floppy. Selection of bus adapters. Distributed Processing Technology, Box 1864, Maitland, FL 32751. 305/830-5522.

CIRCLE NO. 201 ON INQUIRY CARD

VT100



PC100™ SOFTWARE TURNS YOUR PC INTO A VT100/102/52 TERMINAL

Requires: IBM type PC*, 64K, 1 drive, 25x80 display, async adpt., and IBM DOS or OS/2.

PRICED FROM \$89.

Optional: Local Printer & File Transfer

*Available Soon For TI Professional

For more information call or write:

gms GENERAL
MICRO
SYSTEMS

7525 MITCHELL ROAD, SUITE 101, MPLS MN 55344
(612) 937-9194

IBM is a registered trademark of International Business Machines
PC100, GMS are trademarks of General Micro Systems

CIRCLE NO. 202 ON INQUIRY CARD

Serial ◀▶ Parallel

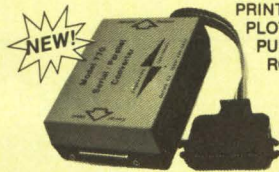

PRINTERS!
PLOTTERS!
PUNCHES!
ROBOTS!

**Convert What You Have
To What You Want!**

- * RS232 Serial
- * 8 Baud Rates
- * Latched Outputs
- * Centronics Parallel
- * Handshake Signals
- * Compact 3 1/4" x 4 1/4" x 1 1/2"

No longer will your peripheral choices be limited by the type of port you have available! Our new High Performance 700 Series Converters provide the missing link. Based on the latest in CMOS technology, these units feature full baud rate selection to 19.2K, with handshake signals to maximize transfer efficiency. Detailed documentation allows simplified installation. Order the Model 770 (Ser/Par) or Model 775 (Par/Ser) Today!

only **\$89.95**
Connector Option \$10.00
CA Residents 8% tax
UPS Shipping \$3.00

Buffer Products
Coming Soon!

Engineering
Specialties
1501-B Pine Street
Post Office Box 2233
Oxnard, California 93020

CALL (805) 487-1665 or 487-1666
For FAST Delivery

CIRCLE NO. 203 ON INQUIRY CARD

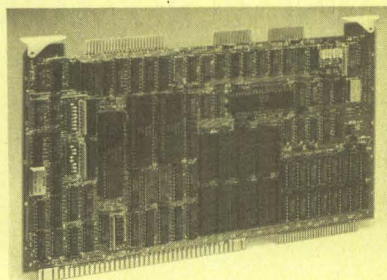

Z800™ MULTIBUS™ SBC

Z8001 or Z8002 16-bit CPU (6 MHz); 32K/128K DRAM; up to 48K static RAM; up to 128K EPROM; 2 RS232 ports (Z8030 SCC); 40 parallel I/O lines and six 16-bit counters (Z8036 CIOs); vectored interrupts; two 8-bit DIP switches; software available. Z800™ Zilog, Multibus™ Intel Corp. **SINGLE BOARD SOLUTIONS**, 7669 Rainbow Dr., Cupertino, CA 95014. (408) 253-0181

CIRCLE NO. 204 ON INQUIRY CARD

Like-new products

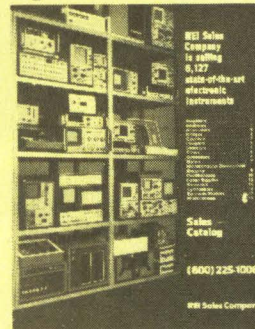

For free catalog,
phone toll-free (800) 225-1008
In Massachusetts (617) 938-0900

Genstar REI Sales Company

CIRCLE NO. 205 ON INQUIRY CARD

To advertise call: Lorraine Marden, 617/536-7780.

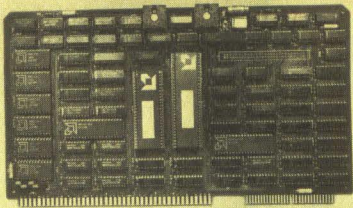

SINGLE BOARD ARRAY PROCESSOR for Multibus* computers. Key features include:

- Dual Port Access - to both program and data memory
- Speed - 16 million operations per second
- Memory Mapped - 4K by 48 bit program memory and 8K by 24 bit data memory
- Standard Routines - for FFTs, PSDs, correlations, deconvolutions and digital filtering
- Versatile - other routines may be developed using Marincos MARASM assembler Interger and Full Floating Point operation.

MARINCO COMPUTER PRODUCTS
11760 Sorrento Valley Rd.
San Diego, CA 92121
(619) 453-5203 TELEX 69-7901

CIRCLE NO. 206 ON INQUIRY CARD

**COMPLETE
68000 DEVELOPMENT TOOLS
FOR VAX/VMS***

MOTOROLA PASCAL → 68000
optimizing cross-compiler..... \$2995
MOTOROLA 68000 relocatable
cross-assembler \$ 995
MOTOROLA cross-linker..... \$ 995
VMS ↔ VERSADOS†
file transfer..... \$ 395

All products run in VAX native mode.
Developed in cooperation with Motorola for guaranteed EXORMACS/VERSADOS† compatibility.

*tm Digital Equipment Corp. †tm Motorola

octal
INCORPORATED

1951 Colony Street, Mountain View, CA 94043
(415) 962-8080 Telex: 172933
CIRCLE NO. 207 ON INQUIRY CARD



MICRO RESEARCH SC Introduces SACC-IBS, the most powerful Control system specially designed for OEMs.

- Features include:
- Modular design with 0805A CPU
 - Up to 56K of RAM, EPROM and EEROM mixed
 - 48 Parallel and 1 Serial line RS-232C
 - Connects directly to IBS-INTERFACE
 - 4 Channels of A/D with 10 bits accuracy
 - 2 16 Bit external event counters/timers 2 MHz
 - 2 External interrupts for fast control
 - Expandable with plug-in modules
 - Requires 110VAC or 12VDC
 - Built in an Industrial 19" rack 1.7" high
 - Includes multitasking Industrial BASIC in 3 EPROMS

Available from stock with generous OEM discounts
Contact

MICRO RESEARCH SC
95 rue Verbist, Brussels, Belgium
Tel: 02/7369040 Tlx: 63552

CIRCLE NO. 208 ON INQUIRY CARD

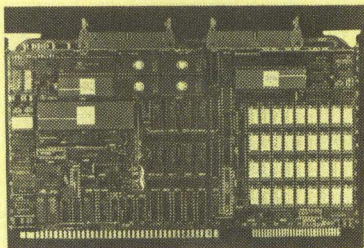

"68000 MULTIBUS FAMILY OF SINGLE BOARD COMPUTERS. Featuring 8 or 10 MHz processors, 128 or 256kB single or dual port no-wait-state memory, expandable to 8MB. Async, Bisync, and HDLC ports with RS232, 423 and 422. Up to 64kB of EPROM, 6-16 bit timers, Centronix or SASI parallel I/O. All are multimaster, 5V only and software compatible. Available with UNIX, Fortran, Pascal and others. From \$1990 qty/1. PACIFIC MICROCOMPUTERS, 119 Aberdeen Drive, Cardiff, CA 92007. (619) 436-8649.

PACIFIC MICROCOMPUTERS, INC.
119 Aberdeen Drive
Cardiff, California 92007
Telephone (619) 436-8649

CIRCLE NO. 209 ON INQUIRY CARD

NEW PRODUCT!

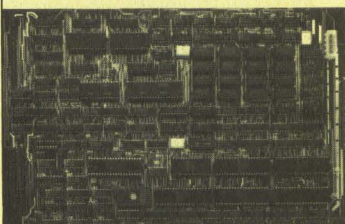

**CP/M Z80-A
SINGLE BOARD COMPUTER**

- On board video • Wide line and thin line graphics • 128K of RAM • Sasi interface • Floppy disk controller for up to four 5-1/4 or 8 inch drives, single/double density simultaneously • 4 serial ports • Full Centronics printer port • Expansion bus • Extended track buffer • 16K printer buffer • DMA • Compact size

\$750.00 4-6 weeks delivery
\$10.00 shipping

IEE
INSIGHT ENTERPRISES CORPORATION
373 N. Western Ave., Suite 12
Los Angeles, CA 90004. (213) 461-3252
Dealer. OEM. International Inquiries Welcome.

CIRCLE NO. 210 ON INQUIRY CARD

PERIPHERALS

Specialists in everything in computers and peripherals. Aside from the Main Frames, we are good at:

- CRT Displays • Disk Drives
- Printers • Key Boards
- Power Supplies
- I/O Expansion Kits
- PROM Programmers/Erasers
- Connector Assemblies
- Board Computers
- Microprocessors
- ICs • LSIs • Semiconductors
- ETC.

When inquiring, please specify your requirements in details.

KAI SHOJI CORP.
Shibuya, P.O. Box 166
Shibuya-ku, Tokyo 150, JAPAN Telex: J28551 KAISHOJI

CIRCLE NO. 211 ON INQUIRY CARD

**ORDER
FORM**

Advertise in the **MINI-MICRO MARKETPLACE**

Please run my advertisement in the following issues

Please specify category:

- Software Hardware
 Literature Services
 Other _____

1983 RATES

1x	3x	6x	12x	18x
\$560	\$540	\$520	\$500	\$480

MATERIALS

1. Glossy photo with 50-75 words.
We will typeset your ad at no charge.
2. Camera ready artwork.
3. Film negatives: right reading emulsion side down.

AD SIZE: 2 1/4" x 3 1/16"

COMPANY _____

ADDRESS _____

CITY _____

STATE _____

ZIP _____

TELEPHONE _____

SIGNATURE _____

Space reservation by the first week of the month proceeding issue date.

- Materials enclosed Materials to come Please send information

Send to: Lorraine Marden, **MINI-MICRO SYSTEMS**
221 Columbus Ave.
Boston, MA 02116

15% Agency commission to accredited agencies. Please specify agency.

Classified Ads

hardware



**HEWLETT
PACKARD**
Desktop & Mini
Computer
Products

SAVINGS ALL MODELS

9845B/C 9000 Non-HP memory
9836A 9826A and peripherals

CALL OR WRITE FOR FREE CATALOG

digital resources inc.
Box 23051 Portland, OR 97223 USA
503-246-0202
International Sales Telex 360-143

CIRCLE NO. 231 ON INQUIRY CARD

software

MicroPERT®
Project Management
for Tektronix, IBM PC, XT
For information, call or write
SHEPPARD SOFTWARE COMPANY
4750 Clough Creek Rd.
Redding, CA 96002
(916) 222-1553

CIRCLE NO. 233 ON INQUIRY CARD

STOCK PORTFOLIO Software. Use your APPLE or IBM PC to maintain your Stock Portfolio and produce the reports and information necessary to manage your stocks. Includes Portfolio Maintenance, Inquiry, Analysis, Graphs, Dividend and Sales reports.
MICRO-LOGIC DATA SYSTEMS, INC.
Box 37351, Omaha, NE 68137

CIRCLE NO. 234 ON INQUIRY CARD

software

IBM-PC - PLOT-10
PC-PLOT-II is an intelligent emulation of the Tektronix Model 4010 graphics terminal which runs on the IBM-PC. The program allows display and creation of picture files when connected to a host computer running PLOT-10 (tm) or compatible software. The user may save picture data files on a local diskette as they are received from the host. The program also includes local printer control, and a serial line debug mode. Utility programs included allow the drawing of a local picture data file on the screen, plotting it on a HP Model 7470A pen plotter, printing on a local printer, and scaling. VISA, MasterCard, checks, PO's accepted. \$75.00

MicroPlot Systems Co.
1897 Red Fern Dr.
Columbus, Ohio 43229
614-882-4786 Telex 62186730

CIRCLE NO. 235 ON INQUIRY CARD

timesharing

Discount DG Timesharing Services
Eclipse M/600 AOS

- Low cost small fraction of commercial rates
- 24-hour/day, 7-day/week availability
- Fortran IV, Fortran 5, Fortran 77, BASIC, Assembly, Sort/Merge, CEO/AZTEXT

Contact Kaye Zweig
ENVIRONPLAN
201-325-1544

CIRCLE NO. 236 ON INQUIRY CARD

This space should be working for you.
For details call:
Linda Lovett
(617)536-7780

inventions wanted

**Inventors, Entrepreneurs,
Product Promoters**
wanted to display concepts at national technology trade show.
Call: 1-800-528-6050 X831

CIRCLE NO. 232 ON INQUIRY CARD

Copy Deadline:
Space reservations and advertising copy must be received by the 10th of the month preceding the issue date. Camera-ready mechanicals must be received by the 15th of the month preceding the issue date. For example, to appear in the February issue, copy must be received by January 10; mechanicals by January 15.

CLASSIFIED ADVERTISING ORDER FORM

Mini-Micro Systems classifieds reach more mini-micro people

Rates: \$80.00 per column inch

There is no charge for typesetting classified listings. Plan approximately 50 average words to a column inch, 8 lines of approximately 38 characters per line (3 inch maximum). Please send clean typewritten (double-spaced) copy.

Category: The following categories are available; be sure to specify the category you wish to be listed under: Business Opportunities, New Literature, Selling, Buying, Trading, Seminars, Services, Software, Supplies & Accessories. (Other categories may be employed at our discretion.)

Run this ad in _____ (number issues) Reader Inquiry No. YES NO
Ad size 1 col. wide by _____ inches deep Under _____ (category)
Check enclosed for \$ _____ (Pre-paid orders only)

Signature _____
Name _____ Title _____
Company _____ Telephone No. _____
Address _____
City _____ State _____ Zip _____

**MAIL TO: Linda L. Lovett, Classified Advertising, Mini-Micro Systems,
221 Columbus Ave., Boston, MA 02116**

Mini-Micro Systems

Career Opportunities/Recruitment Advertising

Rates

	Page	3/4	1/2	1/3	1/4	Col. Inch
1x	\$3,390	\$2,660	\$1,815	\$1,360	\$910	\$90
3x	3,290	2,560	1,745	1,310	860	85
6x	3,190	2,485	1,690	1,260	835	80
12x	2,990	2,335	1,590	1,210	785	75
18x	2,790	2,170	1,480	1,160	735	73
24x	2,740	2,135	1,455	1,110	720	71
36x	2,690	2,100	1,430	1,060	705	70
48x	2,640	2,060	1,400	960	690	60

Circulation

Over 95,000 technically sophisticated professionals in computer operations/systems management, data communications, engineering management, systems engineering/integrators, educators and systems programming specialists.

Recruitment
Hot Line

(203) 964-0664

Call your ad in—
we'll set the type
at no charge.

Mail Film to:

Peggy Gordon
Recruitment Manager
CAHNS PUBLISHING CO.
999 Summer St.
P.O. Box 3809
Stamford, CT 06905

UNUSUAL HARDWARE & SOFTWARE OPPORTUNITIES

Develop
MICROPROCESSORS
SYSTEMS

\$27,000 — \$49,000

Our client, one of the leaders in the development of advanced hardware & software information systems, has immed. opportunities avail. in Systems Analysis, Systems Programming, Software Systems Engineering and Hardware Design. This rapidly expanding company is developing high impact Microprocessor based systems involving the latest State-of-the-Art technology in the areas of Color Graphics, Command & Control, Voice & Data Communications, etc.

If you have 2 or more years of professional experience in software development with a proficiency in FORTRAN or Assembly language OR have a technical degree and experience in microprocessor applications or hardware/software interfacing, please send your resume today or call this week:

(800)336-3755

In Va. call collect (703)790-1284

STAFFING CONSULTANTS

8027 Leesburg Pike
Vienna, VA. 22180 (lic)

CLIENT COMPANIES ASSUME ALL FEES

CIRCLE NO. 240 ON INQUIRY CARD

EMPLOYMENT SERVICE FOR PROGRAMMERS AND ANALYSTS

National Openings With Client Companies
and Through Affiliated Agencies

Scientific and commercial applications • Software development and systems programming • Telecommunications • Control systems • Computer engineering • Computer marketing and support.

Call or send resume or rough notes of objectives, salary, location restrictions, education and experience (including computers, models, operating systems and languages) to either one of our locations. Our client companies pay all of our fees. We guide; you decide.

RSVP SERVICES, Dept. MM
Suite 700, One Cherry Hill Mall
Cherry Hill, New Jersey 08002
(609) 667-4488

RSVP SERVICES, Dept. MM
Suite 211, Dublin Hall
1777 Walton Road
Blue Bell, Penna. 19422
(215) 629-0595

From outside New Jersey, call toll-free 800-222-0153

RSVP SERVICES

Employment Agents for Computer Professionals

CIRCLE NO. 241 ON INQUIRY CARD

Computer Consultants Corner

TKC • THE KEENAN CORPORATION

FCC 15J WE WROTE THE BOOK

"Digital Design for Interference Specifications"

- FCC/VDE & Static Retrofit and Testing
- "Front End" Design Guidance

R. Kenneth Keenan, Ph.D.

421 Mill St SE Vienna, VA 22180
(703) 938-5582 TLX 469030 TKC CI

CONTRACT SYSTEMS ENGINEER

- Bachelors: Chemical Engr., Univ. of Wis.
- Masters: Industrial & Systems Engr., Univ. of Fla.
- Advanced Graduate Record Exam: 95%
- 18 yrs. applying computers toward industrial process control
- Hour, Day, Week, Month Rates
- Anywhere, Anytime, Anything, Any Language

Discuss with **BILL WEDEL**, 904-932-4315

6800/68000 Experts

• Microprocessor hardware and software design • Industrial control specialists • Hierarchical software design methodology • Complete prototype facilities

CLIENTS INCLUDE: Sohio • Elgar • Schlumberger • Motorola • Gulf Oil • Carborundum • Renal Systems

CSA Computer System Associates
7562 Trade St., San Diego, CA 92121 (619) 566-3911

OUR TECHNOLOGY IS VERY SOPHISTICATED. OUR LIFESTYLE IS STATE-OF-THE-HEART.

Imagine...a sophisticated environment utilizing the latest in 16-bit technology, high resolution graphics, networking and ergonomic design.

...an atmosphere which will encourage you to accept higher levels of responsibility, show your potential, interact with management, and help shape the direction of the company.

...a beautiful lakeside community with friendly neighbors, good schools and affordable housing just 90 minutes from Chicago.

All of this and more is waiting for you at Zenith Data Systems in St. Joseph, Michigan, a leader in microprocessor technology. We are presently seeking qualified individuals for the following positions.

HARDWARE DESIGN ENGINEERS

Candidates should have a BSEE and at least 3 years experience in hardware design of 8-bit and 16-bit (8085, 8086, 6800) based computer and terminal systems. Programming experience in Assembly language is desired. Responsibilities will include digital and/or electronic circuit design, design evaluation and system test.

SOFTWARE ENGINEERS

Engineers needed for enhancement of operating systems for microcomputer products. Responsibilities include utility design, adaptation of existing products to microcomputer systems, and reviewing/specifying hardware interfaces. BSCS (or equivalent degree), demonstrated knowledge of Assembly level language (8080/Z80, 68000/Z8000/8086) and experience with operating system development (preferably CP/M, HDOS, and UNIX) is required.

Zenith Data Systems...our technology is up to the minute, our lifestyles are very down to earth. We provide attractive salaries and an outstanding benefits program. For consideration, send a resume in confidence to **Duane Trombly, Zenith Data Systems, Hilltop Road, St. Joseph, MI 49085.**

ZENITH | data systems

A Wholly Owned Subsidiary of
Zenith Radio Corporation

An Equal Opportunity
Employer M/F/H/V

CIRCLE NO. 242 ON INQUIRY CARD



• ENGINEERS • PROGRAMMERS • ANALYSTS

MEET 35 EMPLOYERS

INTERVIEWING IN 30 CITIES NATIONWIDE

SALARIES \$24,000 to \$75,000

Engineering:

Microprocessor
Real-time control
Peripherals
Simulation
Systems

Computers:

Business EDP
Electronics
Electrical
Mechanical
Manufacturing
... and other related areas

UNIQUE BENEFITS FROM ATTENDING OPPORTUNITY CENTERS PERSONAL INTERVIEW: You have an opportunity to meet representatives of top firms in a single day or evening in complete privacy.

FREE SALARY SURVEY: We will send you the Sanford Rose Associates' Salary Survey which reflects current salaries.

COMPANIES WHO HAVE ATTENDED

AT & T

Bausch & Lomb
Burroughs Corp.
Mead Digital Systems
Computer Sciences
Fairchild Microprocessor
Digital Equipment
Eastman Kodak
Emerson Electric
Exxon USA
General Dynamics

GTE

Hewlett Packard
Honeywell, Inc.
IBM
ITT
3M Company
Magnavox
Martin Marietta
McDonnell Douglas
Morse Borg Warner

NCR

Raytheon Corp.
RCA
Sperry Rand
Northrop Corp.
Texas Instruments
TRW
Westinghouse
Xerox Corporation
Plus Local Firms
And Many Others

Send resume or hand-written brief to:
Ed Rose

Opportunity Center

265 S. Main Street, Suite 8080
Akron, OH 44311



CIRCLE NO. 243 ON INQUIRY CARD

National
Business
Employment
Weekly

Current
Career
Opportunities
Coast to Coast

Are you looking for a really good EDP position?

Start Your Job Hunt Right Here . . .
with the National Business
Employment Weekly

Every week, it includes hundreds of the best executive, managerial and professional positions available across the country. Jobs in every field, including data processing and virtually every area of technical expertise. Jobs at salaries from \$25,000 to \$250,000.

PLUS . . . weekly editorial features covering every aspect of career advancement. Articles on writing resumes, interviewing, salary statistics, regional employment trends, and much more.

LOOK FOR OUR SPECIAL OCTOBER 30TH
"DATA PROCESSING" ISSUE WHICH
WILL INCLUDE ADDITIONAL EDP OP-
PORTUNITIES AND RELATED EDITORIAL.

Pick up a copy of the National Business Employment Weekly at your newsstand today.

Or we'll send you the next 8 issues by first class mail. Just send a check for \$32.00 to:

National Business Employment Weekly
Dept. MM 420 Lexington Ave., NY,
NY 10170

CIRCLE NO. 244 ON INQUIRY CARD

THINKING OF A MOVE?

If you're considering making a move, **Career Opportunities** can bring your qualifications to the attention of the top companies, nationwide.

As a service to our readers, a new section, **Situations Wanted** is now available. Simply fill out the following form (all information strictly confidential) and return with your pre-payment of \$20.00 to:

Name _____

Address _____

City _____ State _____ Zip _____

Home Phone _____

PLEASE PRINT YOUR COPY CLEARLY _____

Peggy Gordon
Mini Micro Systems
999 Summer St.
P.O. Box 3809
Stamford, CT. 06905

You will be assigned a Box No. and all responses will be mailed to you immediately. Please keep your copy to 1 inch (approximately 30 words).

SYSTEMS APPLICATION MANAGER

Would you like to work with a more progressive management team?

Can you apply the latest structured management techniques through the entire project life cycle, but are unable to do so in your present situation?

Then look to SUPREME.

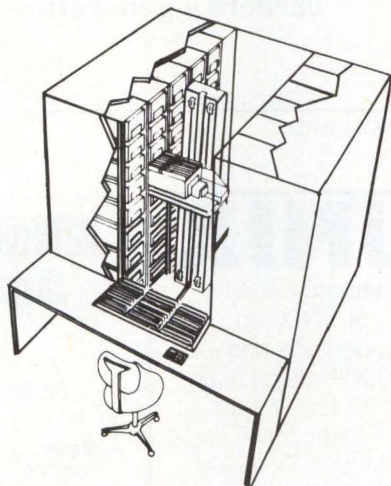

Our business is the automated warehouse/factory, where we develop and implement entire systems.

We are now expanding our Application Software group. You will be involved with complex systems utilizing state-of-the-art technology and requiring sophisticated management techniques. The successful candidate will possess background/interest in the following:

- **Managing the entire project life cycle of an applications system**

- **Coordinating the analysis, design, coding and maintenance functions**
- **Developing and ensuring procedure/documentation standards within the group**
- **Applications in process control, networking and real time inventory control**
- **Minicomputer applications hardware (primarily IBM and DEC)**

If this is your profile, we would like to begin a dialogue at once. This key opening provides salary commensurate with education and experience including full benefits package. Send resume to: Mr. R.S. DiSalvio, Vice-President of Human Resources.

**Supreme
Equipment
& Systems
Corporation**



170 53rd Street, Brooklyn, N.Y. 11232
an equal opportunity employer m/f

SOFTWARE PRO'S—OFFICE AUTOMATION

IF YOU'RE WHERE IT "CAN'T BE DONE" AND YOU THINK THAT IT CAN ... COME TO DATA GENERAL AND DO IT.

We weren't the first kid on the block with a word processing system. But when Data General's CEO™ system made its entrance, it incorporated essential office functions in a totally integrated system that had everything from data and word processing to OCR and document exchange.

But — as usual at Data General — the best is yet to come. We are now moving ahead to the next generation, aiming toward integrating more useful capabilities into CEO™: voice input with electronic mail, electronic spreadsheet and text-graphics manipulation, along with distributed data processing. And more.

Our OA development program is proceeding at an accelerated pace, in the capable hands of small, 2-3 member teams. At that rate, you can move up to project management a lot sooner, too.

If you feel comfortable in an environment where you get a chance to do it your way, and you have some good ideas about word processing, information management, text manipulation and formatting, voice mail, or distributed processing ... start the action right now.

Please send your resume with salary history to Emily Atkinson, D137-OA-11, Data General Corporation, 4400 Computer Drive, Westboro, MA 01580. We are an equal opportunity employer.

 **Data General**
careers a generation ahead.

CIRCLE NO. 246 ON INQUIRY CARD

ENGINEERS

Choice positions available in New England and Nationwide. Hardware, Software, Commercial and defense industries.

Microprocessor Control	to 60K
Mini/Micro Software	to 60K
A/D Circuit Design	to 45K
Fiber-Optics	to 45K
Test Engineers	to 45K
Graphics Software	to 50K
Systems Software	to 45K
UNIX & "C"	40's
Network Dev.	to 45K
Video Circuits	to 40K
Electronic Packaging	to 50K
Logic Design	to 45K

All fees and expenses paid. Call or send resume to:

LARSEN PERSONNEL
1492 Highland Avenue
Needham, MA 02192
(617) 449-3840

Personal computer users:

FOR FREE ACCESS TO A BETTER JOB CALL CLEO.

(213) 618-8800 (408) 294-2000
(415) 482-1550 (714) 476-8800
(619) 224-8800
Standard ASCII code
Access assistance:
(213) 618-1525

CLEO

Computer Listings of Employment Opportunities

UNIX

National Registry
of UNIX job
openings and
UNIX Professionals
P.O. Box 19949
Dept. MMS
Houston, TX 77224
Please send resumes.



Scientific Placement, Inc.

ENGINEERS/SOUTHEAST

Affiliated offices throughout the Southeast. Positions in systems integration, systems analysis, software, mini-micro applications, programming, 25-60K. Aggressive, confidential. Fee paid service. Send resume to: Ted F. McCulloch.

McCULLOCH & CO.
P.O. Box 10211
Greenville, SC 29603

Mini-Micro Systems

Recruitment
Advertising Schedule

Month	Closing Date
December	11/14/83

To place your ad in Mini-Micro Systems call or write:

Peggy Gordon
Recruitment Manager
CAHNS PUBLISHING CO.
999 Summer St.
P.O. Box 3809
Stamford, CT 06905
(203) 964-0664

More and more advertisers of minicomputers, microcomputers, CRT terminals, printers, disk drives, memories, modems, distributed data processing systems, etc., are consistently turning to **MINI-MICRO SYSTEMS**. Call **Peggy Gordon** at **203-964-0664**.

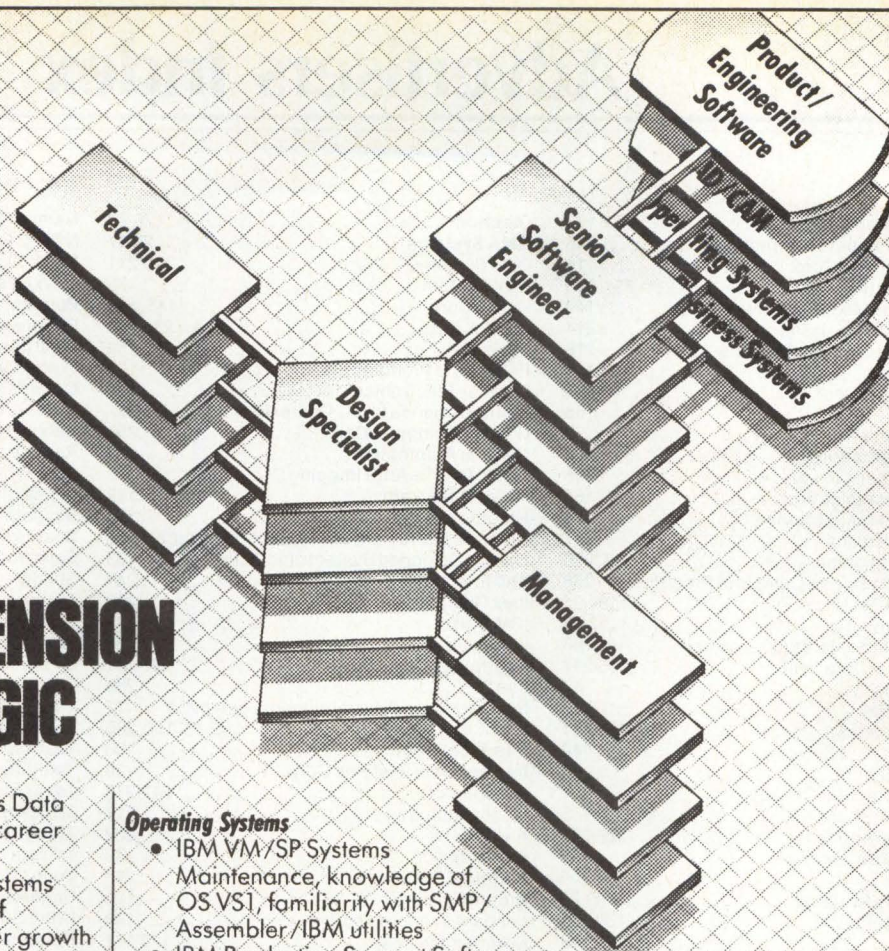

MULTIDIMENSION CAREER LOGIC

Coming to General Dynamics Data Systems Division is a logical career move because:

We provide skilled data systems professionals a wide range of opportunities for stable career growth and success.

We support the largest, multinational coproduction program in history... the F-16 Falcon, which means high visibility, diverse and challenging assignments and industry recognition — whether your career goals lead to technical specialization or management.

Software Engineers and Applications Programmers with a BS degree and at least 3 years' experience may find themselves working in one or more of the following areas:

Business Systems

- COBOL — Business Applications on IBM 3033, 3081, CDC CYBER, TANDEM or IBM 8100
- Database Management Systems, IMS DB/DC
- IBM Data Dictionary, VSAM, IMS Utilities, ADF, Database Design
- RAMIS, Model 204, other relational DBMS
- TSO, SPF, JCL

Operating Systems

- IBM VM/SP Systems Maintenance, knowledge of OS VS1, familiarity with SMP/Assembler/IBM utilities
- IBM Production Support Software: PAN*DA, RAMIS, ASM2, ABEND-AID, Disk Management
- CDC CYBER COMPASS Assembler and NOS-BE Systems Maintenance
- CDC CYBER NOS/BE System User Support using CDC FORTRAN, Interactive Systems
- VAX VMS Operating System Maintenance and Application Programming
- IBM, VAX Systems Configuration and Planning

Product/Engineering Software

- Scientific programming, real-time processing, graphics, digital signal or numerical analysis on DEC PDP 11 or VAX 11/780, Harris, IBM or CDC Mainframes
- Man-in-the-loop simulation applications using Digital/Analog/Array Processor Computer Systems
- C³I Systems, Ada Language Developments, Software Engineering Technology

- Modern and Classical Control Theory, Estimation Theory, Parameter Identification Methodology

CAD/CAM

- Knowledge of CADAM Internals
- COMPUTERVISION System Internals
- APT-AC Systems Software
- CAD/CAM Architecture

We offer a comprehensive benefits package which includes: competitive salaries, medical and dental insurance, savings/stock investment program, plus exclusive use of our fully equipped, 80-acre recreation facility and 18-hole, championship golf course.

If this is the kind of career logic that appeals to you, please send your resume to: **D.H. Huckaby, Division V.P./Director, Central Center, Data Systems Division, P.O. Box 748-044, Mail Zone 5300, Fort Worth, TX 76101.**

GENERAL DYNAMICS

Data Systems Division

An Equal Opportunity Employer, M/F, U.S. Citizenship Required

Advertisers Index

Able Computer	182	Disctron	76-77	Namiki Precision Jewel Co.	272
Advanced Computer Communications	248	DMA Systems	96-97	NCR, OEM Marketing Div.	224-225
Advanced Digital Corp.	14	Dual Systems	210-211	North Star Computer	18
Air Land Systems	287, 289, 291, 293	Dy-4 Systems	75	Onyx Systems	136
Ampex Corp., Memory Products Div.	140	Dysan Corp.	145, 156	Percom	93
Ann Arbor Terminals Inc.	214	Emulex Corp.	45, 238-239	Peripheral Technology	128
Applied Data Communications (ADC)	218	Envision	138-139	Pixel (Instrumentation Laboratory)	261
Archive Corp.	105-112	Falco Data Products	155	Pryor Corp.	58
Arete Systems Corp.	36-37	Faraday Electronics	116	Quietprint Inc.	286
Atasi Corp.	68	Fujitsu America Inc.—Printer Div.	132	Qume	127
BASF Systems	79	Gavilan Computer Corp.	254	Rabbit Software Corp.	87
Beehive International	228	General Automation	84	Racal-Vadic Inc.	223
Bit 3 Computer	158	Gould Inc., DeAnza Imaging Div.	6	Saturn Systems	222
Bridge Communications	185	Hewlett-Packard	119	Scientific Micro Systems	48, 257
Brown Disc Manufacturing	274	Hiac/Royco	194	Seagate Technology	67, 252-253
C. Itoh Electronics	17	Houston Instrument Div. of Bausch & Lomb	55	Seattle Computer Products	273
Cahners Publishing Co.	7, 276	Human Designed Systems Inc. (HDS)	33	Seiko Instruments USA	122-123
CalComp (California Computer Products)	258	IBC/Integrated Business Computers	243	Shugart Corp.	22-23
Callan Data Systems	94-95	Ibex Computers Corp.	208	Softcon	13
Canaan Computer	52-53	IBM Corp.	247	Spectra Logic Corp.	64
Century Data Systems (a Xerox Co.)	98	Illbruck/USA	293	Standard Micro Systems	272, 274, 276, 278
Charles River Data Systems	236-237	Infotron Systems Corp.	120-121	Systems Group	113
CIE Systems	47	Inmac	289	Tandberg Data Inc.	196-197
CIE Terminals	10	Intecolor Corp., and Intelligent System Co.	177	Tandon Corp.	8-9
Cincom Systems	250-251	Intel Corp.	42-43, 150, 206	TEAC Corp. of America	264
Ciprico	40	Interface Group	198	Tektronix Inc.	90-91
Codata Systems	62	Intertec Data Systems Corp.	39	TeleVideo Systems	70-71
Compaq Computer Corp.	1	Iomega Corp.	212-213	Texas Instruments Inc.	160-169
Complexx Systems Inc.	5	IQ Technology	217	3R Computer Corp.	265, 278
Computer Memories	226-227	Karl Leister	222	Trilog, Inc.	244
Computer Resource, Inc.	59	Kennedy Co.	C2	TriData Corp.	193
Comtal	200	Kierulff Electronics	267	Tulin	56-57
Corona Data Systems	82-83	Kimtron	188	Ungermann-Bass	63
Cromenco Inc.	130-131	Lanpar Technologies, Inc.	148	Unify Corp.	199
CXI	88	Lear Siegler Inc.	170-171	Unisoft Systems	208
Danish Data Electronics	114-115	Liberty Electronics USA	187	Universal Data Systems Inc.	191
Data General Corp.	60-61	Liebert Corp.	279, 281, 283	Verbatim Corp.	240
Data Packaging	124	Mass Comp	147	Visual Technology Inc.	153
Dataproducts	235	Maxell Computer Products Div.	72	Western Digital	159
Dataram	26, 81	Megatape	203	Western Peripherals Div. Wespercorp	C3
Data Set Cable	146	Method Systems Inc.	158	Western Telematic, Inc.	4
Data Sources	195	Micom Systems Inc.	C4	Wicat Systems Inc.	102-103
Data Systems Design Inc.	24-25, 262-263	Micro Memory Inc.	277	Wyse Technology	34
Davidge Corp.	54	Micro Peripherals Inc. (MPVI, Calif.)	101	Xycom	4
Davong Systems	21	MicroPro International	209		
Delta Airlines	205	Micro Technology	232	See p (298-303) for Career Opportunity Advertisers	
Digital Equipment Corp.	231	Mini-Micro Systems	178, 266, 268, 271, 275, 288	See p (297) for Computer Consultant Corner	
Dilog (Distributed Logic Corp.)	179	3M Co.	134-135	See p (295-296) for Mini-Micro Marketplace	
Direct Inc.	180-181	Modcomp	50		
Disc Instruments	172	Momentum Computer Systems	143		

This index is provided as an additional service. The publisher does not assume any liability for errors or omissions.

REGIONAL SALES OFFICES

BOSTON

Robert K. Singer
National Sales Manager
Norma E. Lindahl
Assistant To The National Sales
Manager

John J. Fahey
Eastern Regional Manager
221 Columbus Ave.
Boston, MA 02116
(617) 536-7780

PHILADELPHIA

Richard W. Molden
Regional Manager
999 Old Eagle School Rd.
Wayne, PA 19087
(215) 293-1212

CHICAGO

Robert D. Wentz
Regional Manager
Cahners Plaza
1350 E. Touhy Ave.
P.O. Box 5080
Des Plaines, IL 60018
(312) 635-8800

DALLAS

Don Ward, Regional Manager
13740 Midway Suite 515
Dallas, TX 75234
(214) 980-0318

DENVER

John Huff, Regional Manager
270 St. Paul St.
Denver, CO 80206
(303) 388-4511

LOS ANGELES

Len Ganz
Regional Manager
12233 West Olympic Blvd.
Los Angeles, CA 90064
(213) 826-5818

ORANGE COUNTY

Debra Huisken, Regional Manager
2041 Business Center Drive
Suite 109 Irvine, CA 92715
(714) 851-9422

SAN FRANCISCO

Frank Barbagallo
Regional Manager
Rick Jamison, Regional Manager
Sherman Building, Suite 1000
3031 Tisch Way
San Jose, CA 95128
(408) 243-8838

AUSTRIA

Elan Marketing Group
Neutor g. 2
P.O. Box 84
1010 Vienna, Austria
Tel: 43-222-663012 or -638461

ENGLAND

Ian Hardman Systems International
Quadrant House, The Quadrant
Sutton Surrey, SM2 5AS England
Tel: (01) 661-3022

ISRAEL

Elan Marketing Group
13 Haifa St., P.O. Box 33439
Tel Aviv, Israel
Tel: 972-3-252967 or -268020 Telex: 341667

JAPAN

Tomoyuki Inatsuki
General Manager
Trade Media Japan Inc.
R. 212 Azubou Heights
1-5-10 Roppongi Minato-ku,
Tokyo 106 Japan
Tel: (03) 587-0581

NETHERLANDS

Elan Marketing Group
World Trade Center for Electronics
Pastoor Peter Str. 34, P.O. Box 2085
5600CB Eindhoven, Netherlands
Tel: 31-40-442575

SWEDEN

Elan Marketing Group
Humlegardsgatan Nr. 5
11446 Stockholm, Sweden
Tel: 46-8-677243 or -676243

WEST GERMANY

Elan Marketing Group
Sudring 53
7240 Horb/Neckar, West Germany
Tel: 49-7451-7828

Career Opportunities

Peggy Gordon
Recruitment Advertising Manager
999 Summer Street P.O. Box 3809
Stamford, CT 06905
(203) 964-0664

from out of the West...

TAPE DIMENSION III

DEC COMPATIBLE CONTROLLERS

Tape Dimension III is the only buffered tri-density (GCR/PE/NRZI) TS-II™-emulating controller on the market. The combination of its unique asynchronous handshake design and 64K byte buffer enables it to take full advantage of bus speeds without the risk of causing data late conditions in other bus transfer operations. It makes Tape Dimension III particularly adaptable to systems with high speed disk drives.

The 64K byte buffer provides total immunity to data late conditions, even at high-speed data rates on a highly populated peripheral bus. In fact, Tape Dimension III actually has greater capability than the TS-II!

Tape Dimension III is completely software-transparent to the VAX™ and PDP-11™ Unibus environment including diagnostics in VMS.

The Tape Dimension III controller supports up to four dual-density (Pertec compatible) drives or four tri-density (STC or TELEX type) drives. It is a single embedded hex PC board that fits into any standard SPC slot.

This new dimension in tape transfer dramatically reduces the ratio of protocol to information data. And tremendously increases the efficiency of Unibus utilization. Find out how much it can improve your system throughput. Call or write today for complete information. WESTERN PERIPHERALS, Div. of WESPERCORP, 14321 New Myford Rd., Tustin, CA 92680, Tel: (714) 730-6250, Cable WESPER, TWX 910-595-1775, Telex 472 0629. Wesper International GmbH, Tel: 089 982420. Wesper International (U.K.), Tel: (44) 0276-20934.

TS-II, VAX and PDP-11 are trademarks of Digital Equipment Corporation.



western peripherals

Division of **WESPERCORP**

SEE US AT COMDEX

CIRCLE NO. 1 ON INQUIRY CARD

Don't waste your money on modems for local networking.

Whether you're connecting your terminal or personal computer directly to a nearby minicomputer or to a data PABX-based local network, you probably don't need a modem at all.

MICOM's inexpensive Micro400 line drivers and local datasets can substitute for regular modems over distances of several miles and at full-duplex data rates up to 19,200 bps. Then, because they're asynchronous devices, they can allow you to operate at any speed within their total range

(rather than limiting you to one or two data rates as a synchronous device would). And—even better—they're priced at a tiny fraction of the cost of a high-speed modem.

Also unlike conventional modems, MICOM's tiny Models 430 and 431 require no extra cabling—not even a power cord. They simply plug into the back of your terminal or PC.

Looking for a better way to transmit data over your own lines or over metallic circuits supplied by the phone company? Call or send for information on MICOM's Micro400s.

Considering
a bunch of modems
for local networking?

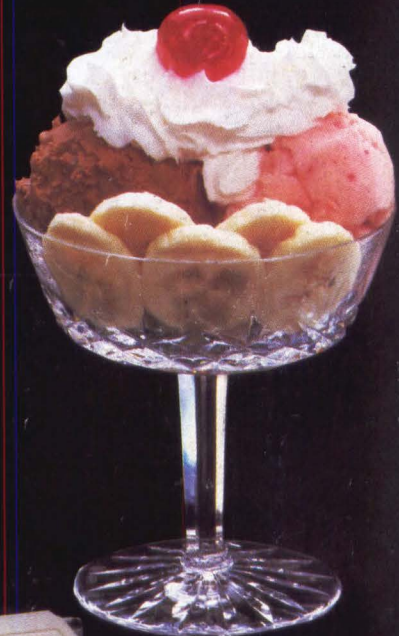

You'll find
our local datasets
more appealing.

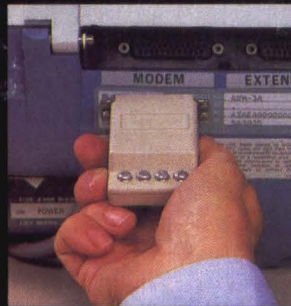

MICOM® *MicroComputers for DataCommunications*™

MICOM SYSTEMS, Inc. • 20151 Nordhoff Street • Chatsworth, CA 91311 • Telephone (213) 998-8844 • TWX 910/494-4910
Regional Sales/Service • Atlanta, GA • (404) 435-2999 • Boston, MA • (617) 527-4010 • Chicago, IL • (312) 789-2430
Dallas, TX • (214) 258-0774 • St. Louis, MO • (314) 576-7626 • Teaneck, NJ • (201) 836-4000
MICOM-BORER Ltd. • Bel Court • 15 Cradock Road • Reading, Berkshire RG20JT, England • (0734) 866801 • Telex 847135

Available now from these stocking reps...

AK: Anchorage (907) 561-1776 / Juneau (907) 789-4101 • AL: (800) 327-6600 • AR: (214) 620-1551 • AZ: (602) 994-5400 • CA: Anaheim (714) 635-7600 / Lodi (209) 334-1961 / San Diego (619) 565-1557 / San Jose (408) 298-7290 • CO: Colorado Springs (303) 594-0880 / Denver (303) 777-8070 • CT: (617) 235-5520 • DE: (609) 779-0200
FL: (800) 432-4480 • GA: (800) 327-6600 • HI: (808) 537-9758 • IA: (402) 895-5850 • ID: (801) 466-6522 • IL: (312) 255-4820 • IN: (317) 846-2591 • KS: (816) 252-3700
KY: (502) 228-5401 • LA: (800) 327-6600 • MA: (617) 235-5520 • MD: (301) 261-4344 • ME: (617) 235-5520 • MI: (313) 588-2300 • MN: (612) 425-4455 • MO: Independence (816) 252-3700 / St. Louis (314) 721-0401 • MS: (800) 327-6600 • MT: (801) 466-6522 • NC: (800) 327-6600 • ND: (612) 425-4455 • NE: (402) 895-5850 • NH: (617) 235-5520
NJ: North (201) 569-2353 / South (609) 779-0200 • NM: Albuquerque (505) 292-1212 / Las Cruces (505) 524-9693 • NV: (714) 635-7600 • NY: Albany (518) 459-5891 / Buffalo (716) 662-4568 / New York City (201) 569-2353 / Rochester (716) 442-5631 / Syracuse (315) 638-2042 • OH: Cleveland (216) 524-5930 / Dayton (513) 434-7500
OK: (405) 478-5000 • OR: (503) 224-3145 • PA: East (609) 779-0200 / West (412) 892-2953 • RI: (617) 235-5520 • SC: (800) 327-6600 • SD: (612) 425-4455
TN: (800) 327-6600 • TX: Dallas (214) 620-1551 / Austin (512) 327-8600 / El Paso (915) 542-1762 / Houston (713) 353-7728 • UT: (801) 466-6522 • VA: (301) 261-4344
VT: (617) 235-5520 • WA: (206) 454-2383 • WI: (414) 784-9379 • WV: East (301) 261-4344 / West (412) 892-2953 • WY: (303) 777-8070 • Washington, DC: (301) 261-4344
Puerto Rico: (809) 723-9689

CIRCLE NO. 2 ON INQUIRY CARD