

Mini-Micro Systems

A CAHNERS PUBLICATION

FEBRUARY 15, 1985/\$15.00

Communications Digest

**The product guide
for system integrators**

46556 NOTRAVHLR04 / 01
501 11 2 F 3 GIK 3343
R HELLENTHAL APRCF
NOTRE DAME UNIV
BIOLOGY DEPT
NOTRE DAME IN 46556

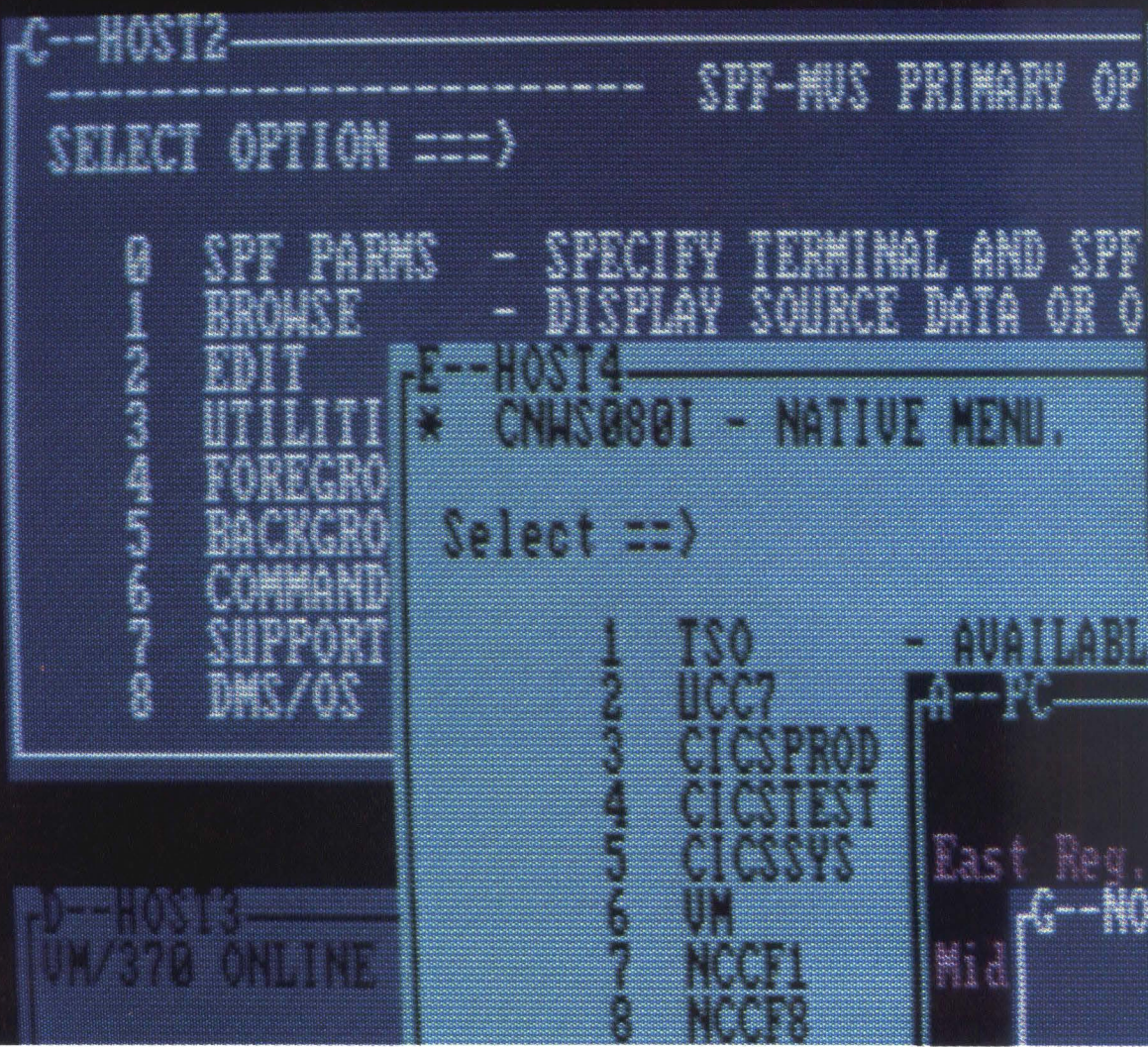

How to turn the PCs you have

Simple.

Just plug in the CXI 3270 PC connection. It's an add-in board with software. And it can turn your IBM® PC, XT, AT or compatible into a full-fledged coaxial- or modem-attached 3270 PC.

Just like that.

So you can access and “window” up to five host applications at the same time. On the same screen. There's also

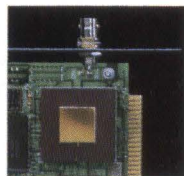

a window for running a PC DOS application. Which can be programmed to talk with any host session—or all five at once. Not to mention two electronic notepads.

The coaxial connection attaches to a 3274 cluster controller. While the modem connection lets you work remotely without the need for a controller.

It gets better.

Our 3270 PC connection lets you use

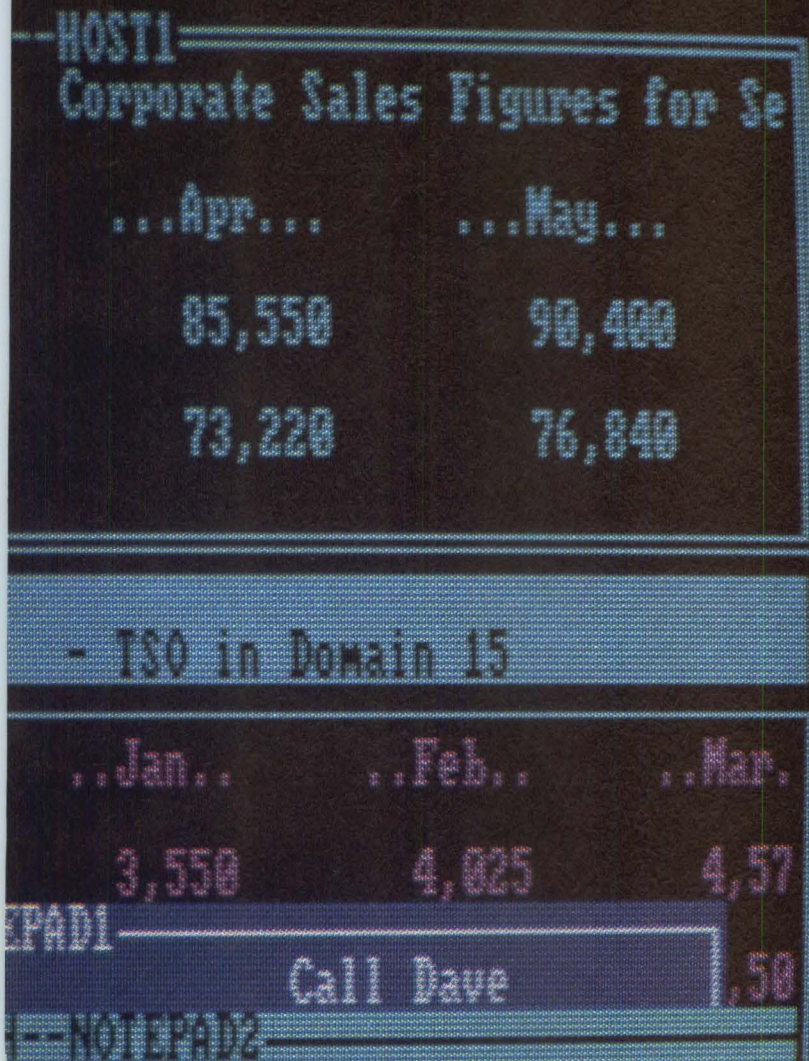

into the 3270 PCs you need.



inexpensive PC-attached printers in place of host-addressable IBM 3287s. And it can run all the software already written for the IBM PC.

What's more, international keyboard mapping and file transfer come standard.

For those who don't require full 3270 PC capability, we also offer the CXI 3278/79 PLUS PC connection. It lets you work with one host session,

one PC program and two notepads—concurrently.

So for more information about our line of CONNECTWARE™ products, or for the name of your nearest distributor, call 800/221-6402. In California, call 415/424-0700. Or write CXI, Inc., 3606 West Bayshore Road, Palo Alto, CA 94303. TELEX 821945.

And find out how to turn the PCs you have into the 3270 PCs you need.



COVER THE MARKETPLACE WITH THE WIDEST SELECTION OF IBM BLUE AVAILABLE.



ATTENTION OEMS

Let Systems Strategies help you cover the large and profitable marketplace of IBM™ mainframe communications. Our software allows your computer system to emulate IBM terminals, workstations and printers. With our family of communications software, your hardware appears "Big Blue."

EXPERIENCE

Systems Strategies was the first to develop 3270 SNA and 3270 BiSync support running under UNIX™. Our many years of experience in, and commitment to, this highly specialized technology can save you development time and money. Let us do the work to keep up with the changing shades of blue as IBM communications evolve. You reap the benefits of our expertise.

BROADEST PRODUCT RANGE

We have the broadest range of communications software available for UNIX and non-UNIX environments, allowing mini and micro computer systems to communicate with mainframes or networks using SNA/SDLC or BiSync. The CCITT X.25 interface is also available. Our family of products can serve your evolving information access needs, now and in the future.

COMPLETE EMULATION

Systems Strategies provides a perfect match to Big Blue. Our products provide full SNA/3270, BSC/3270, SNA/RJE (3770)

and BSC/RJE (2780, 3780, HASP) emulation. The integrated Applications Program Interface provides the capability for interactive transaction processing, file transfers, and fully integrated applications across mainframe and workstation boundaries. No IBM host modification is required.

PORTABILITY

All Systems Strategies' software products are written in 'C', using internal designs and architecture which make the communications and device emulation logic independent of the hardware and operating system on which the products are to run. This unique design makes them exceptionally portable to both single and multi-processor environments.

Call or write today for more information: Systems Strategies Inc.
225 West 34th St. New York, NY 10001. (212) 279-8400.



Systems Strategies Inc.

An AGS Company

Experience...the main link in communications software

Mini-Micro Systems

Communications Digest

A CAHNERS PUBLICATION

VOL. XVIII NO. 3 FEBRUARY 15, 1985

7 Editorial

11 How to use the Communications Digest

13 MODEMS . . . Bell system breakup redirects modem market
Dedicated phone line price increases, coupled with decreasing prices for dial-up service, spurs use of higher-speed DDD modems

25 DDD MODEMS Product Guide

39 MULTIPLEXERS . . . Multiplexers keep pace with datacomm needs
As communications networks increase in size and complexity, multiplexers are meeting the challenges of proliferating terminals, rising datacomm costs and T1, X.25 and satellite links

50 MULTIPLEXERS Product guide

59 LOCAL AREA NETWORKS . . . Emerging standards trigger \$3B LAN market
Finally the software is here that allows LANs to fulfill the promise of shared data

68 LOCAL AREA NETWORKS Product guide

89 NETWORKING SOFTWARE . . . The search is on for standards, security
Networking software is matching hardware to hardware while opening up application opportunities for value-added resellers and system integrators

92 NETWORKING SOFTWARE Product guide

99 VOICE/DATA COMPUTER/TERMINALS . . . Voice-data integration enters war for desktops
Telephone, computer and terminal manufacturers try a new mix of product capabilities to secure larger shares of the office-automation marketplace

104 VOICE/DATA COMPUTER/TERMINALS Product guide

108 DIRECTORY OF MANUFACTURERS . . . alphabetical listing of company addresses and phone numbers

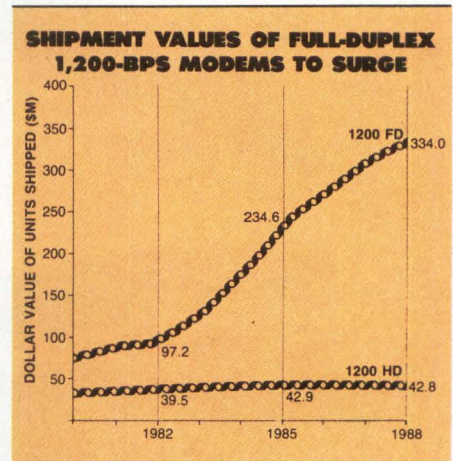

p. 13 Modems on the move

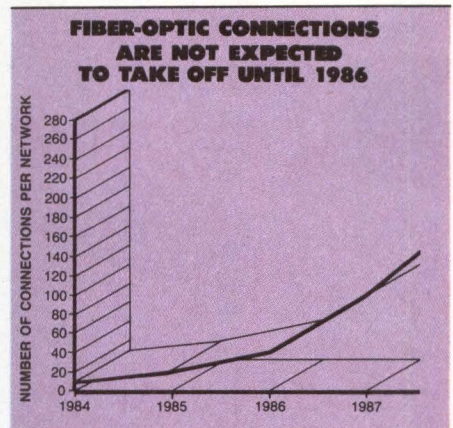

p. 59 Fiber-optics take off

DEPARTMENTS

- 4 Editorial Staff
- 114 Career Opportunities
- 122 Index to Advertisers
- 129 Mini-Micro Marketplace

MINI-MICRO SYSTEMS (ISSN 0364-9342) is published monthly (with 4 special Digest issues) by Cahners Publishing Company, Division of Reed Holdings, Inc., 221 Columbus Avenue, Boston, MA 02116. Norman L. Cahners, Chairman; Saul Goldweitz, President and Chief Executive Officer; Ronald G. Segel, Executive Vice President and Chief Operating Officer. MINI-MICRO SYSTEMS is published by the Cahners Magazine Division: J. A. Sheehan, President; William Platt, Executive Vice President. Circulation records are maintained at Cahners Publishing Co., 270 St. Paul St., Denver, CO 80206. Second class postage paid at Denver, CO 80202 and additional mailing offices. Postmaster: Send address changes to MINI-MICRO SYSTEMS, 270 St. Paul St., Denver, CO 80206. MINI-MICRO SYSTEMS is circulated without charge by name and title to U.S.- and Western European-based corporate and technical management, systems engineers, and other personnel who meet qualification procedures. Available to others at the rate of \$65.00 per year in the U.S.; \$70.00 in Canada and Mexico; \$95 surface mail in all other countries; air mail surcharge, \$35.00 (16 issues). Special DIGEST issues, \$15.00. Single issues \$5.00 in the U.S.; \$6.00 in Canada and Mexico; \$7.00 in all other countries.

© 1985 by Cahners Publishing Company, Division of Reed Holdings, Inc. All rights reserved.



INTRODUCING THE CTS 212AH MODEM

Discover in nine minutes
what it's taken ninety years
to develop;
Reliability.



CTS Technological Reliability

The high speed, digital signal processor in our 212AH modem was originally engineered for very complex, custom modem systems. We now have applied this advanced technology to a standard Bell 212A compatible product. You get clear, error free transmission despite varying phone line conditions. Other features include auto dial/answer, remote digital loopback, full duplex 300 bps and 1200 bps asynchronous operation and 1200 bps synchronous operation. In a few minutes you'll discover our modem has all the bells and whistles you could ask for. Yet, at a surprisingly low price.

CTS Field Reliability

We warranty our 212AH modem for two years, and we demand our distributors service and support your needs immediately. Once in the field, our modems operate with all data terminals, more than 100 types of computers and are Hayes compatible.

CTS Brand Reliability

In 1896 CTS began manufacturing hand cranked, wooden, wall mounted telephones. Today, we offer the sophisticated 212AH modem. It's taken us almost ninety years of hard work, intensive research and innovative products to develop a reputation for reliability. Take nine minutes, examine our 212AH modem, and find out for yourself.

CTS®

DATACOMM Products Division

131 West St.

Danbury, CT 06810

203-743-3681

New to the industry since 1896.

STAFF

Vice President/Publisher
S. Henry Sacks

Editor-in-Chief
George V. Kotelly

Managing Editor
James F. Donohue

Assistant Managing Editor
Bruce J. MacDonald

Senior Western Editor: **Jerry Borrell**
San Jose, (408) 296-0868
Senior Editor: **Lori Valigra**
Senior Projects Editor: **Rick Dalrymple**

Western Editor: **Carl Warren**
Los Angeles, (213)826-5818
Senior Associate Editor: **David Simpson**
Associate Editor: **Frances T. Granville**
Associate Editor: **Lynn Haber**
Associate Editor/Research: **Frances C. Michalski**
Associate Editor: **Gregory Solman**
Associate Editor: **Michael Tucker**
Associate Editor: **Jesse Victor**
Assistant Editor: **David Bright**
Assistant Editor/New Products: **Eileen Milauskas**
Assistant Editor/Research: **Pamela Gorski**
Assistant Editor/Research: **Megan Nields**

Contributing Editors

Raymond C. Freeman, Jr.
Freeman Associates
Tokyo: **Neil Gross**
Taiwan: **Charles Hintermeister**
London: **Keith Jones**, (011-441-661-3040)
Tokyo: **Ichiro Kakehashi**
Data Communications: **Walter A. Levy**
Frankfurt: **Maureen O'Gara**
United Kingdom: **Tim Palmer**
Washington, D.C.: **Stephen J. Shaw**
(202) 387-8666
Gene R. Talsky
Professional Marketing Management Inc.

Editorial Production

Senior Copy Editor: **Arsene C. Davignon**
Production Editor: **Mary Anne Weeks**
Assistant Copy Editor: **Sharon Hassell**
Administrative Assistant: **Nancy Norton**

Editorial Services

Terri Gellegos

Assistant to the Publisher: **Linda L. Lovett**

Executive Editor,
Cahners Computer Publications
Alan R. Kaplan

Art Staff

Art Director: **Vicki Blake**
Assistant Art Director: **Cynthia McManus**
Artist: **Anne Tregay**

Director of Art Dept.: **Norm Graf**

Production Staff

VP Production: **Wayne Hulitzky**
Supervisor: **William Tomaselli**
Production Manager: **Lisa Sisterhenm**
Composition: **Diane Malone**

Editorial Offices

Boston: 221 Columbus Ave., Boston, MA 02116. (617)536-7780. **Irvine:** 2041 Business Center Dr., Suite 109, Irvine, CA 92715. **Los Angeles:** 12233 W. Olympic Blvd., Los Angeles, CA 90064. **San Jose:** 3031 Tisch Way, San Jose, CA 95128. **New York:** 33 Arcadia Dr., Dix Hills, NY 11746. **London:** P.O. Box 37E, Worcester Park, Surrey, KT48RQ, England.

Reprints of Mini-Micro Systems articles are available on a custom printing basis at reasonable prices in quantities of 500 or more. For an exact quote, contact Art Lehmann, Cahners Reprint Service, Cahners Plaza, 1350 E. Touhy Ave., Box 5080, Des Plaines, IL 60018. Phone (312)635-8800.

Engineered for Excellence



We put more into the Davong DataSystem™

so you can get more from your Personal Computer.*

You are interested in more productivity. Davong designed the DataSystem for convenience, versatility, and reliability.

Convenience is built-in. Like the package design that slips under your monitor. And installation that's a snap. Put one adapter in a short slot. Connect one cable. Plug it in and go. And you don't need to be an expert to use our software. Menu-driven programs with simple commands and on-line information put you at ease.

Versatility is unsurpassed. DataSystem tape accepts true DOS commands (COPY, etc.) so you can make file-by-file backups. You can even run programs from tape. Or, back up entire disk volumes in minutes with our Tape Manager program. Your data speeds to tape at one million characters a minute. Just data. DataSystem doesn't waste your tape space with non-data areas. And tape capacity is always guaranteed.

Choose from 10, 21, 32 or 43-megabyte disk sizes plus 24 megabytes of removable tape storage. Emulate an XT with Davong Fixed Disk software or enhance your computer's performance with optional Davong Multi-OS® software. And Multi-OS readies the DataSystem for Davong MultiLink™ networking.

Reliability is assured. Only fully-tested components are used in the DataSystem. Before it leaves quality control, each drive must pass days of rigorous system-level tests—and the rack. Each DataSystem must survive a torturous burn-in with no problems. Only then do we consider it good enough for your desk.

If you have the Data, Davong has the System for you. Convenience, versatility and reliability. Why settle for less?

*IBM® PC, XT, AT, and many compatibles

IBM® is a registered trademark of International Business Machines Corporation.
Multi-OS®, Davong DataSystem™, and Davong MultiLink™ are trademarks of Davong Systems, Inc.



Davong Systems, Inc.
217 Humboldt Court
Sunnyvale, CA 94089
Phone: (408) 734-4900
Telex: 176386

CIRCLE NO. 4 ON INQUIRY CARD

RODIME

The optimum
combination of
capacity, reliability
and price

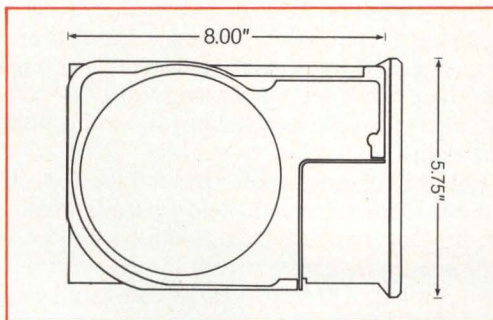
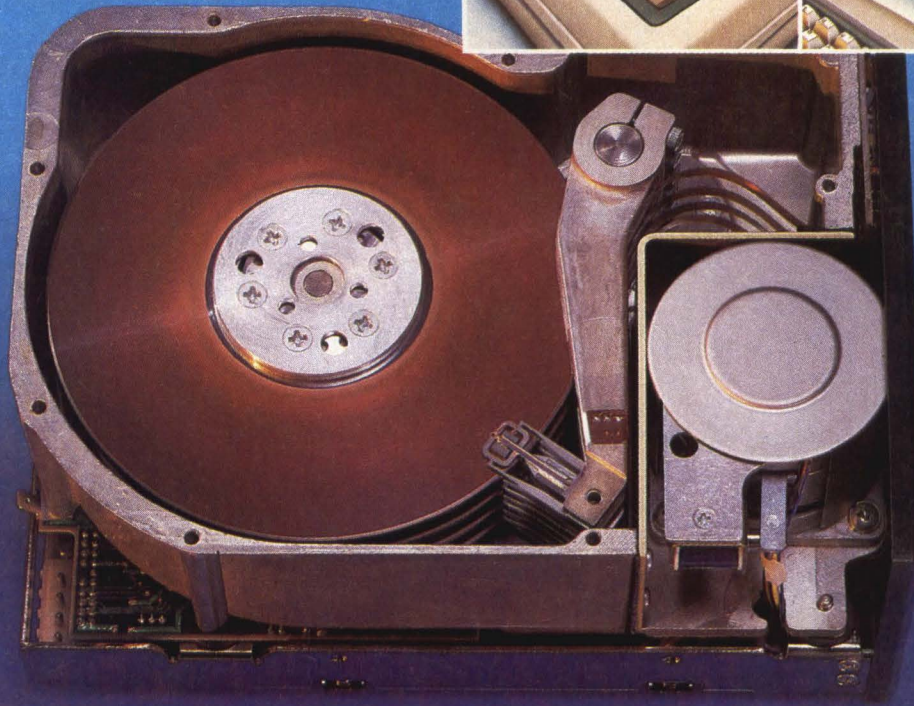
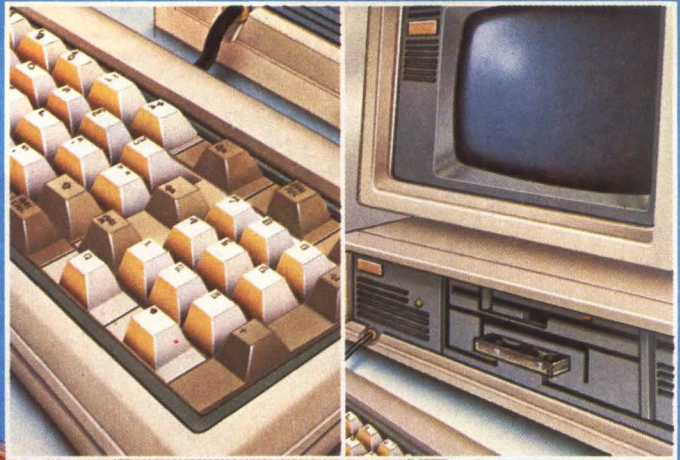

Our 200E hard disk drives are the lowest-priced medium capacity (13-53 Mbyte) 5 1/4" drives on the market. Technology, not compromise, gives you this price advantage. Our leadership in micro-processor-controlled stepper motor design has enabled us to bypass expensive closed loop voice coil actuators, giving you

optimum performance at a significant savings. This third generation of 5 1/4" drives reflects our four years of production and field experience. Rugged construction and ultra-reliable performance—as expected from Rodime—have been still further enhanced. Phone or write for our 200E Series data sheet and brochure.

RODIME

901 Broken Sound Parkway, N.W. • Boca Raton, FL 33431 • (305) 994-6200
West Coast—Mission Viejo, CA (714) 770-3085 • Central—Austin, TX (512) 453-5135

CIRCLE NO. 5 ON INQUIRY CARD



DIGESTS EXPAND TO DATA COMMUNICATIONS

This, our first *Communications Digest*, is one of four special *Mini-Micro Systems* issues to be published this year. Like our *Computer Digest*, issued each June, the *Communications Digest* will be published annually in February. These two, along with our *Peripherals Digests*, published in April and November, make up our 1985 digest schedule.

We have chosen 1985 to introduce our first *Communications Digest* because it's a year in which most system integrators are expected to incorporate data communications features into their value-added products. Interconnectability of computer systems has clearly risen from a desirable feature to a necessity. As we approach the 1990s, interconnectability will increasingly reshape the architectures of almost all computer systems. No longer can system integrators view their products as only standalone solutions.

This year, all computer system designers will have to be aware of the data communications standards now in place and the many that have yet to be specified. To learn about the standards, or lack of standards, in each of five product categories, turn to the staff-written articles that begin each *Digest* section. Then, to see which products are already on the market, turn to the product guide following each article.

Since the new *Communications Digest* is published in February, *Mini-Micro Systems'* regular data communications issue (traditionally scheduled for March) now moves to September. Continuing unchanged in our 1985 editorial calendar are two other special-emphasis issues—June's State of the Market Report and December's State of the Technology Report.

As noted in 1984's *Fall Peripherals Digest*, we have modified the product categories in our peripherals digests so that each category is covered once a year. The *Spring Peripherals Digest* will cover flexible, optical and rigid disk drives and subsystems with platter sizes of 8 to 14 inches; line printers and page printers; ½-inch cartridge tape drives; monitors; and graphics terminals. The *Fall Peripherals Digest* coverage will include flexible and rigid disk drives and subsystems with platter sizes up to 5¼ inches; matrix and solid-font character printers; ¼-inch and smaller cassette/cartridge tape drives; and alphanumeric display terminals.

Our job is to provide timely and complete coverage of product developments in the value-added market. If you have suggestions for improving our product coverage, please send them to the Editor-in-Chief, *Mini-Micro Systems*, 221 Columbus Ave., Boston, Mass. 02116.

Rick Dalrymple
Senior Editor

THE NIU-180 LOWERS COST-PER-CONNECTION.

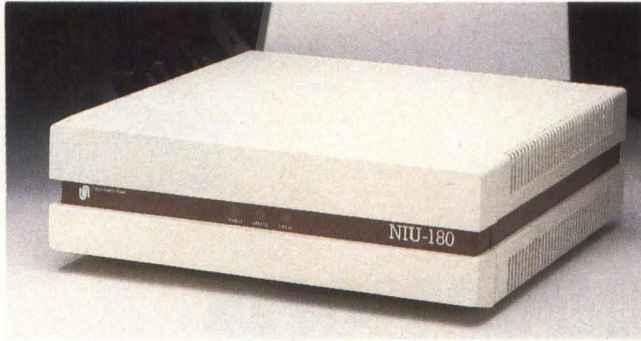

Announcing the NIU-180: the first of an extraordinary new family of Network Interface Units that represents a direction everyone's been waiting for in local area networking. *Much higher performance. Much lower cost.*

In terms of cost-per-connection, the eight-port NIU-180 is the lowest ever.

In areas where equipment is concentrated, the NIU-180's eight RS-232 ports bring per-connection local area network costs to a new low.

With 16-bit architecture and advanced VLSI, we've packed more memory, more functionality, and more flexibility than ever before into a single unit. At substantially reduced costs.

Because these are Net/One® NIUs, the connections can be with the medium of your choice. Broadband, baseband, optical fiber.

And because these NIUs® are Net/One products, they are a compatible extension of Net/One. The only difference is even higher performance than you've come to expect from what was already the high performance standard. More speed. More power. Less money.

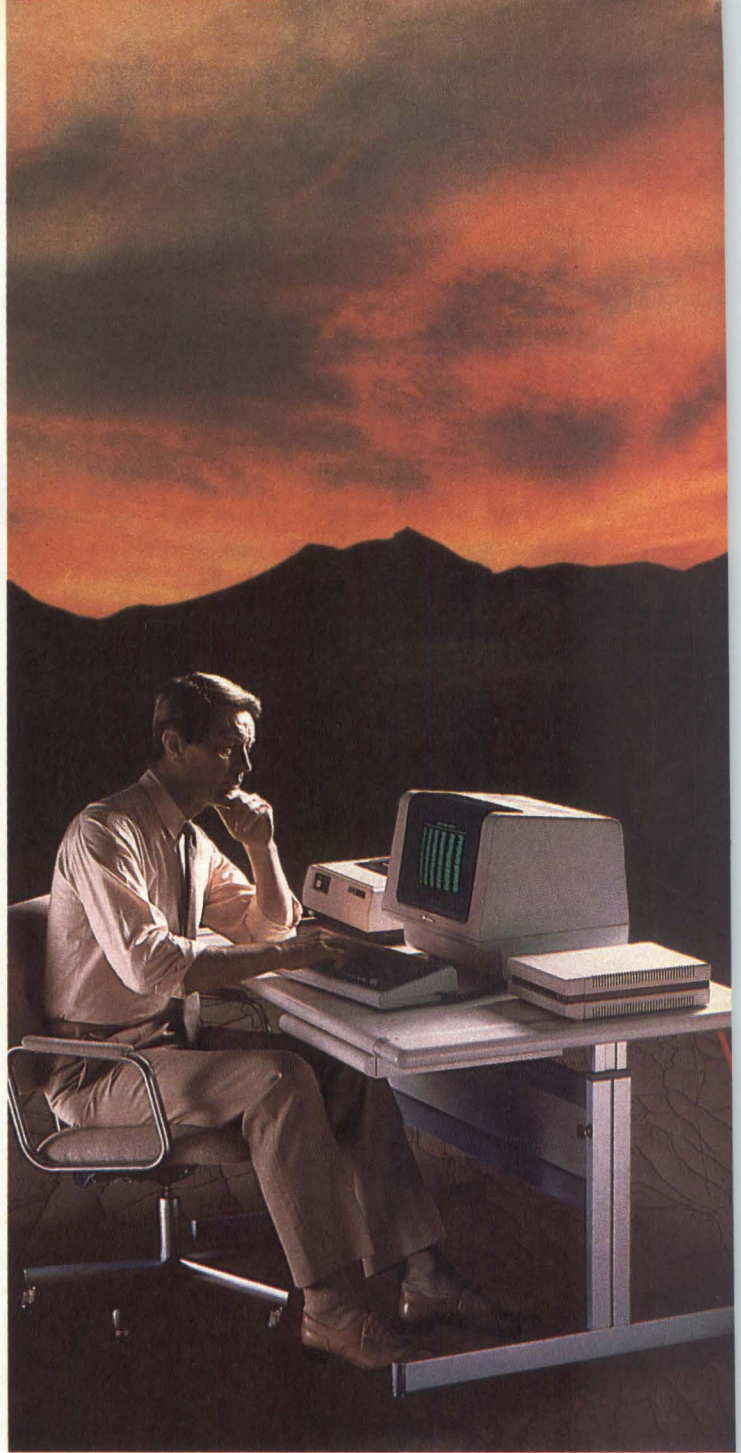

Net/One brings connections out wh

THE NIU-130 LOWERS COST-PER-LOCATION.



Announcing the NIU-130: a two-port NIU that can follow you anywhere at a cost-per-location so reasonable that network connection is feasible where it hasn't been before—particularly in broadband applications. A one-person station on the production floor. An isolated office. A surveillance site.

The NIU-130 unplugs and moves with you easily, and is, like all Net/One products, media-independent.

It takes full advantage of VLSI as well as 16-bit architecture to do more than a single NIU has ever been able to do before. More features. Higher performance. At a cost that keeps the total system cost way down, even when you have to make connections way out.

Give us a call. Ungermann-Bass, Inc., 2560 Mission College Blvd., Santa Clara, CA 95050, (408) 496-0111. Western Region (408) 496-6464. Eastern Region (703) 448-1117. International Offices: Lausanne, Switzerland (021) 267733; Tokyo, Japan (03) 585-5485; Toronto, Canada (416) 494-4426.

Net/One from Ungermann-Bass 

costs down and ere you want them.

CIRCLE NO. 6 ON INQUIRY CARD



THE NEW HIGH SPEED CHAMPION

Bill Johnson, 1984 Olympic Gold Medalist, Downhill

Bill Johnson shot out of obscurity to win the men's downhill and the first ever gold medal for the USA at the Winter Olympics in Sarajevo. He became the new high speed champion! In fact, his years of experience gave him technical superiority and he's kept on winning since. Similarly, Telenetics is the new high speed champion in modems. The company's founders have years of successful experience in telecommunications, the new product family has proven technical superiority.

Telenetics offers one of the first 2400 bps full-duplex integral card modems for IBM PCs and compatible computers. It fills the screen much faster and significantly lowers your data phone costs. The

ExpressData[®] 24i 2400 bps Full Duplex Modem for IBM PC

ExpressData 24i has automatic adaptive equalization and also offers a number of unique user benefits. A toll-free "800" number for remote diagnostics and for instant warranty activation. A Federal Express rapid board replacement program. The latest Crosstalk[™] software that runs everything from the keyboard. A capability of going back and forth between voice and data in the same phone call. A three-year warranty. Plus, a full ExpressData line of 2400 and 1200 bps modems, with the 1200s field upgradable to 2400s.

If you're a systems house using OEM quantities of computers, you've got to check out the ExpressData family.



Telenetics[®]

Telenetics Corporation
895 E. Yorba Linda Blvd.
Placentia, CA 92670
(714) 524-5770

HOW TO USE THE COMMUNICATIONS DIGEST

The *Communications Digest* is divided into six sections—five for product categories and one for the directory of manufacturers. Each of the five product categories begins with a staff-written article followed by one or more product tables.

Each of the product tables contains pricing and specification information, arranged alphabetically by company name. These tables are based on mail- and telephone-survey information.

The directory of manufacturers, the last section of the digest, is a consolidated alphabetical listing of all the vendors. Each directory entry provides a vendor's mailing address and telephone number, as well as a circle number for the reader service card. The main directory is followed by a supplementary directory of manufacturers. This directory, also in alphabetical order, lists known vendors of data communication products who did not respond to our survey.

To use the *Communications Digest* effectively, use the tabs to find the desired product category. To find addresses or phone numbers, use the directory of manufacturers. To check product prices or specifications:

- Turn to the appropriate product category
- Find the product table
- Find the alphabetically listed vendor

To select a product:

- Turn to the appropriate product category
- Refer to the product table
- Refer to the directory of manufacturers for the supplier's address

To comment on the *Communications Digest* or to suggest future product coverage or entries, contact the Editor-in-Chief, *Mini-Micro Systems, Communications Digest*, 221 Columbus Ave., Boston, Mass. 02116.

The *Communications Digest* research and editing staff includes Frances Michalski, associate editor; Megan Niels, assistant editor; and Pamela Gorski, assistant editor. Production assistant Carole Smith provides editorial support.

DDD MODEMS
TABLE 1

MULTIPLEXERS
TABLE 2

LOCAL AREA NETWORKS
TABLE 3

NETWORKING SOFTWARE
TABLE 4

VOICE/DATA PRODUCTS
TABLE 5

DIRECTORY
OF MANUFACTURERS



John Trumbull. *The Declaration of Independence*, 1786-1797. Courtesy The Bettmann Archive.

Installing a worldwide 2400bps dial line data network can save you thousands of dollars in international data communications costs. But before you put your John Hancock on a purchase order, check the facts. To be legally used in most foreign countries, today's 2400bps modems must not only comply with the V.22bis Recommendation, but must also meet dozens of additional design and performance requirements as outlined by each country. And the truth is, most don't. In fact, there is only one company whose family of V.22bis modems has been approved and accepted by *over thirty-five* foreign nations—Concord Data Systems. Concord was the first company to install a V.22bis-compliant 2400bps modem. And, with over 20,000 units in place today, Concord Data is not only the most popular name in 2400bps modems, but is the benchmark for 2400bps modem performance. For complete details on our full line of domestic and international 2400bps full duplex dial line modems, call us at (617) 890-1394 or write 303 Bear Hill Road, Waltham, MA 02154, telex 951793.

Concord Data Systems

Leading the Communications Revolution

See us at Interface, Booth #2110

CIRCLE NO. 8 ON INQUIRY CARD

MINI-MICRO SYSTEMS/February 15, 1985

BELL SYSTEM BREAKUP REDIRECTS MODEM MARKET

Dedicated phone line price increases, coupled with decreasing prices for dial-up service, spurs use of higher speed DDD modems

Stephen J. Shaw, Washington Editor

One event has profoundly affected the modem market. The breakup of the Bell System has resulted in sharp price increases for dedicated phone lines and vigorous competition for dial-up service. This has created a market opportunity for the manufacturers of higher speed Direct Distance Dial (DDD) modems, especially those operating at 2,400 bits per second (bps).

The Bell breakup has also created a dearth of technical transmission standards for modems operating at 2,400 bps and higher. The venerable Bell standard specifications for 300- and 1,200-bps, half- and full-duplex modems—103, 113, 212 and 212A—still retain their hold within the U.S. modem market. However, AT&T Information Systems (ATTIS) has not moved to develop, or impose, standards for higher speed equipment.

Filling this void have been specifications formulated by the Comité's Consultatif Internationale Téléphone et Télégraphique (CCITT), the standards arm of the International Telecommunications Union. U.S. manufacturers are increasingly designing their equipment according to the CCITT specifications for both domestic and international applications.

"There's been a drift away from Bell standards with the breakup," explains Stephen Durham, vice president of product planning and applications for Cermetek Microelectronics Inc., Sunnyvale, Calif. "Even AT&T Information Systems is talking about CCITT-compatible products."

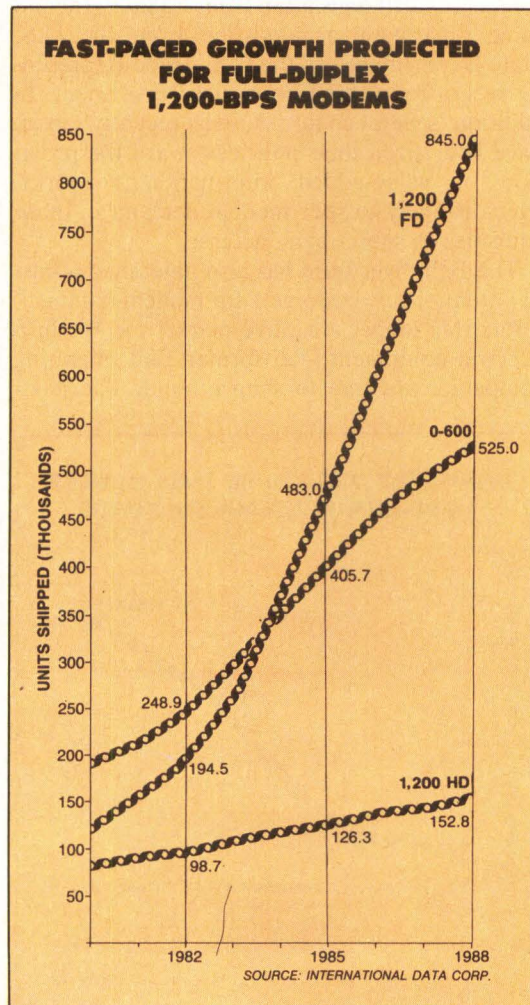

Projected to be the fastest-growing segment of the modem market, 1,200-bps, full-duplex modem shipments will increase at a compound annual rate of 24.7 percent through 1988.

The net result is to allow manufacturers to cease what Durham characterizes as the "the insanity" of developing two separate products—one under a Bell standard and the other CCITT-compatible—for identical domestic and international applications.

Freed from having to develop U.S.-only versions, manufacturers can devote more resources to designing and marketing products for European, Asian and other countries that adhere to CCITT standards for domestic communications.

U.S. modems resemble foreign counterpart

At the same time as U.S.-made modems more closely resemble their non-U.S. counterparts, many foreign governments have begun to liberalize the procurement of modems and other telecommunications equipment that interconnect with state-owned telephone networks. And the telecommunications agencies of many countries have opened their network-interconnect markets to foreign equipment suppliers. This is partly in response to the AT&T breakup, but also to threats of tariff legislation from Capitol Hill and some diplomatic arm-twisting from the U.S. State Department and the U.S. Trade Representative's office of the Commerce Department. In addition, several countries, most recently Japan, have liberalized their policies toward the provision of value-added information networks, which is likely to spur modem demand in those countries as subscribers increase.

The Bell divestiture has also unleashed a host of potential new customers for modem manufacturers. No longer a captive market for Western Electric equipment, the former Bell operating companies are free to shop around. The inde-

pendent Bell companies, their subsidiaries, and other OEM customers represent an increasingly significant market, according to Kim Myhre, communications industry analyst at International Data Corp. (IDC), Framingham, Mass.

Market shift spawns products at 2,400 bps

With private or dedicated line price increases, the 2,400-bps DDD modem has become very attractive. Modems operating at 2,400-bps have been used generally for business applications to carry data to and from "dumb" or low-speed, remote, batch terminals. The market has been dominated almost exclusively by modems requiring the four-wire connections used for private-line service almost exclusively, according to John Krayeski, ATTIS manager for modem products. However, numerous full-duplex modems have recently been announced that achieve the same 2,400 bps throughput over the two-wire channels used in the public dial-up telephone network.

The market for 2,400-bps, full-duplex modems had once been the exclusive domain of Concord Data Systems Inc., a small, Waltham, Mass., manufacturer. Earning \$1.5 million in revenues during 1982, Concord Data's first year in operation, the company recorded \$14.9 million in revenues last year from its CDS 224 line of 2,400-bps full-duplex modems. "We had the market to ourselves for almost two years," says C. Kenneth Miller, Concord Data's president, "but there's a lot of people coming into the market now."

By late last year, only two other manufacturers, Codex Corp., Mansfield, Mass., and Micom Systems Inc., Chatsworth, Calif., were shipping 2,400-bps, full-duplex modems for dial-up applications. But that situation is about to change dramatically. Other vendors who have either announced similar modems recently, or are rumored to have a 2,400-bps full-duplex modem under development, include: ATTIS, Case/Rixon Communications Inc., Cermetek Microelectronics Inc., Gandalf Data Inc., General Datacomm Industries Inc., Hayes Microcomputer Products Inc., Multi-Tech Systems Inc., Novation Inc., Penril/Datacomm Inc., Racal-Vadic Inc. and U.S. Robotics Inc.

The sudden appearance of so many vendors in what was once considered a specialized market niche can be explained by the convergence of three distinct industry trends, explains IDC's Myhre. First, users are nervous about private-line rate increases and are looking for dial-up alternatives that can satisfy their medium-speed, data communications requirements. Secondly, the growing use of personal computers in business is pushing users to demand more speed and

Despite decreasing per-unit prices, rising demand for 1,200-bps, full-duplex modems are expected to push the dollar value of units shipped to \$334 million in 1988.

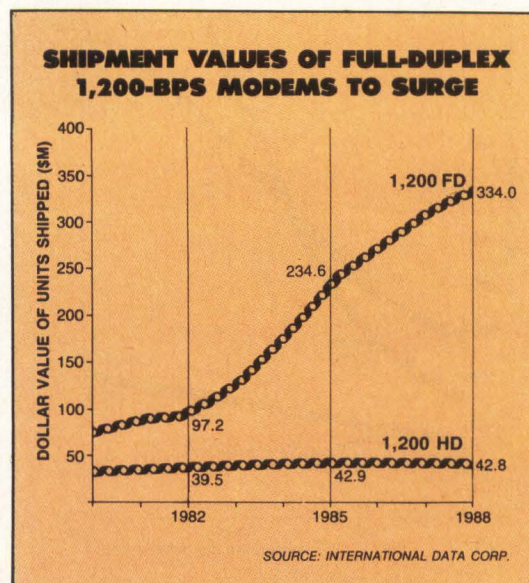

REST ASSURED

THE CERMETEK SECURITY MODEM IS ON THE JOB!

Don't lose sleep worrying about an unattended computer. The CERMETEK SECURITY MODEM is the best guard for the job.

Communication and Security for only \$695 is an unbeatable buy! The Security Modem offers a variety of security options to fit your specific needs. In addition to 4 levels of access security, the modem has originate (dial-out) security and will maintain an audit trail of all access attempts. Changing security options or codes requires a key.

Four Levels of Access Security

🔒 **No Security** — an intelligent 1200/300/110 bps modem, fully compatible with the Hayes SMARTMODEM 1200™

🔒 **Password Only** — requires a valid 8 digit password to access the computer

🔒 **Password and Call-Back** — After receiving a valid password, the modem calls back to the phone number linked to that password in its memory.

🔒 **Password and Call-Back on Second Security Line** — The modem can make the call-back call on a second secret phone line, preventing the interception of the call-back by a sophisticated security breaker.

Additional Modem Features

- 2 year limited warranty
- Auto-dial, auto-answer
- synchronous as well as asynchronous
- call progress monitoring
- 41 auto-dial numbers stored, 25 for call-back numbers in security mode

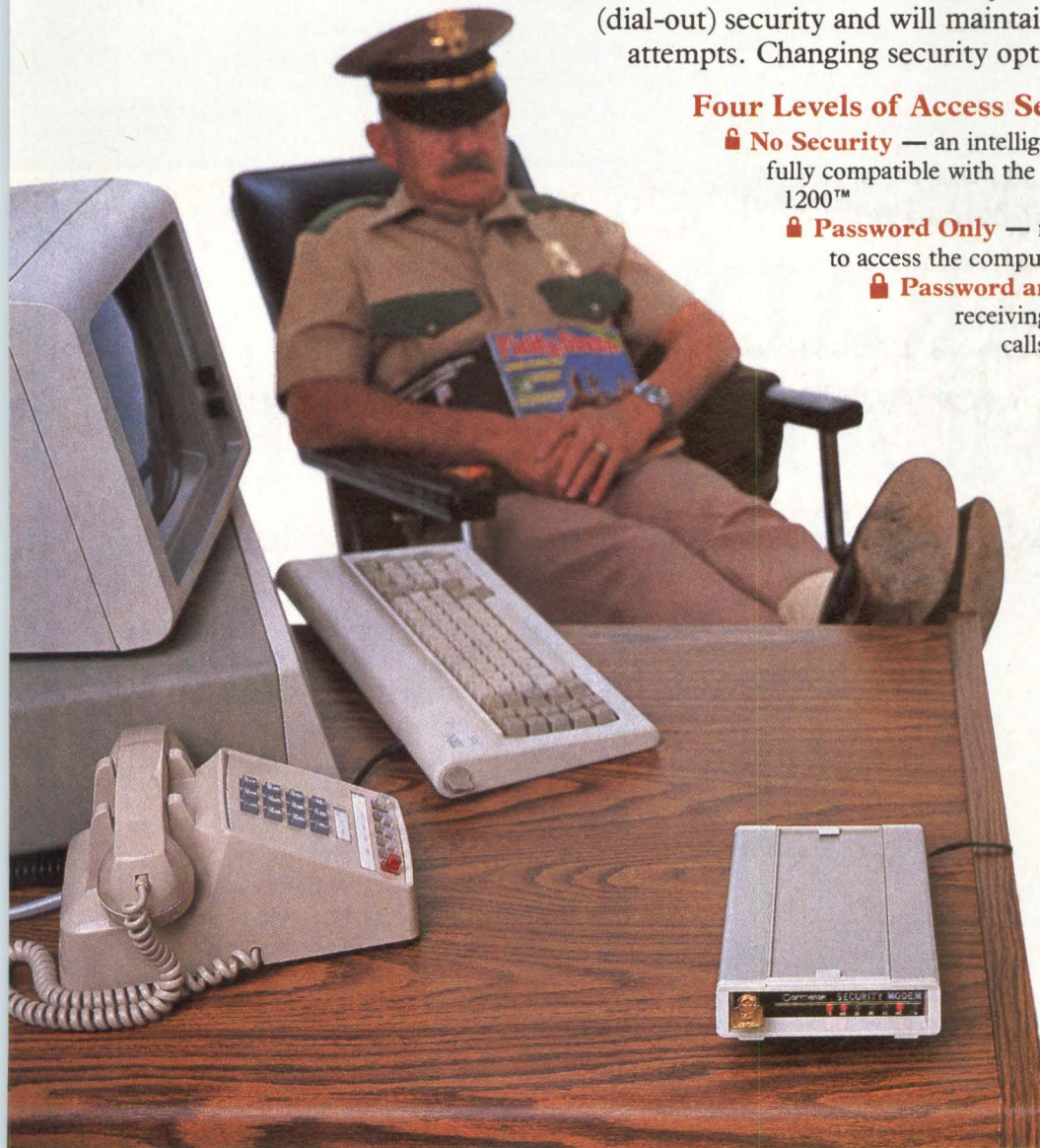

“Communication for your computer, Security for your peace of mind.”

Take this ad to your favorite computer dealer and ask for the CERMETEK SECURITY MODEM.

SMARTMODEM 1200 is a trademark of Hayes Microcomputer Products, Inc.

Cermetek
microelectronics

1308 Borregas Ave.
Sunnyvale, CA 94088-3565
(408) 752-5022

NEW from
THE MODEM LEADER



PARADYNE'S MPX MODEM FAMILY

and a new Advanced Network Management System

Announcing Paradyne's **NEW MPX family of high speed, signal processing modems.** They're quick to install – make three connections, push a few buttons for modem strapping – and they're user ready. Easy up, rarely down. **Modem speeds of 2400, 4800, 9600 bits per second,** operating point-to-point or multipoint, all with automatic adaptive equalization.

Lower power consumption and smaller size too! Only 3½" high, 8½" wide and weighing 5½ lbs.

You're in total control. Press a few keys on the **NEW ANALYSIS 5500 Series advanced network management system, and down-line load strapping** to the MPX modems.



ANALYSIS constantly monitors a **wider range of phone line parameters than ever before.** Controlling your modem network is essential and it's at your fingertips.

Flexibility. The 5500 Series is modular in design for easy upgrade in capacity and features. Its distributed system design supports from a few –

to hundreds of lines – in virtually any network architecture.

ANALYSIS 5500, together with the new family of MPX high speed signal processing modems, can provide the most technologically advanced communication network available today. **Built with Paradyne's quality. Backed with Paradyne's service – around the world.**

Efficiency, expansion, control. Another Paradyne systems solution. If you want your network up, not down, give us a call.

1-800-482-3333

Paradyne Corporation
P.O. Box 1347
• 8550 Ulmerton Road,
Largo, FL 33540

paradyne

CIRCLE NO. 10 ON INQUIRY CARD

data throughput from dial-up modems. Finally, VLSI technology is allowing manufacturers to introduce 2,400-bps modems that are only roughly 50 percent more expensive than 1,200-bps units, but deliver twice as much information in the same amount of time.

Prices, delays deter customers

"Private-line costs are going up while long-distance (dial-up) rates are dropping," says Myhre. As a result, more businesses are looking at dial-up switched service as a cost-effective solution for their data communications needs. Full-duplex, dial-up modems are also finding applications as an interim measure for customers waiting to receive private-line service from AT&T. That has taken up to 160 days.

Manufacturers concur that development of these new modems for business applications has been driven by user demands for increased data-transfer rates. "We're reacting to user need, and users have been crying for more speed over the past year," comments Gary Betty, marketing and sales director for Hayes Microcomputer Products, Norcross, Ga. "Everybody else in the industry has seen the same trends and performed the same market analysis that we have."

It may not be too long before 2,400-bps, full-duplex modems show up in the home, predicts John Borden, a home computer analyst with The Yankee Group, Boston. He says that acceptance of the medium-speed modems for home-computer applications depends on two factors: reducing retail prices to below \$700, the approximate level at which 300 to 1,200 bps began to attract home consumers two years ago, and increasing use of home information subscription services and communications software packages that offer graphics capabilities.

At 1,200 bps, Borden continues, a single frame of videotex takes 20 seconds to create. A 2,400-bps modem would, obviously, cut that time in half and could make graphic-based information services more attractive to home users. "I anticipate that by late 1985 we may see some 2,400-bps modems begin to be available in the home," Borden suggests. "But a lot depends on how well home information services are received."

2,400-bps modems sold to Tymnet

Support of 2,400-bps, full-duplex data transmission by commercial information and network services is also deemed critical if the spate of new modems for dial-up applications is to become widely accepted. Concord Data Systems has already attracted Tymnet Inc., a value-added data network vendor, as a customer. Tymnet has

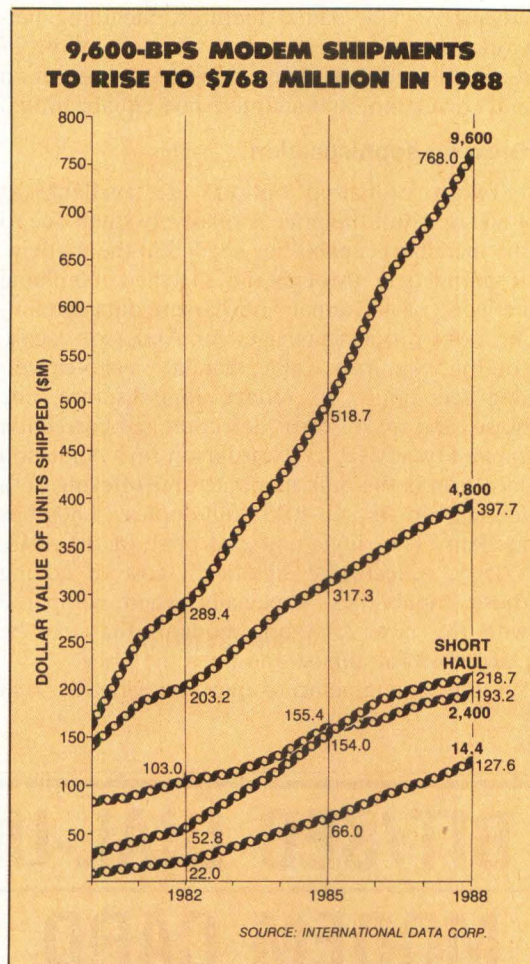

User demands for increased data throughput capabilities, coupled with the anticipated development of new full-duplex equipment at 9,600 bps, should push the value of 9,600-bps modem shipments to \$768 million in 1988.

incorporated Concord's modems by selling them to network subscribers under the TymNet label, says Steve Puchkoff, Concord's vice president of sales.

However, only one other commercial information service, NewsNet, currently supports 2,400-bps transmission speeds. Others, including Dialog, Lexis, Telenet, The Source and Uninet are reportedly looking at whether to support 2,400-bps transmission rates in addition to existing 300- and 1,200-bps connections.

Single-unit prices for the new modems range between \$800 and \$1,500, depending on additional, value-added features. Prices should remain relatively stable through 1985, says Cermetek's Durham, but will drop during the following year by an estimated 10 percent to 15 percent. In the meantime, manufacturers are expected to compete on the basis of capabilities added to differentiate their products in the market. Such features as auto-dial, auto-answer and self-diagnostics are now considered almost mandatory with the new modems. But manufacturers are already starting to incorporate even more

advanced value-added features, including network diagnostics to pinpoint transmission problems along the telephone circuit, error detection and correction, and adaptive line equalization.

Growing sophistication

Two-wire dial-up options are available at 4,800 bps, but the price is relatively steep due to the increased capabilities needed in the modem. Running data through the switched telephone network, says Gunnar Thordarson, data communications product manager for Anderson Jacobson Inc., San Jose, Calif., mandates echo-cancelling techniques to reduce long-distance line noise, and makes error detection and correction capability advisable. Thordarson says Anderson Jacobson is the only manufacturer offering both features in its AJ 4048, full-duplex, 4,800-bps modem. The single-unit, list price of the 4048, \$2,595, reflects the significant cost of adding those capabilities, especially when compared with the new 2,400-bps modems that can be purchased for almost one-third the price.

Other manufacturers question whether that

added development cost would be better spent on products operating at 9,600 bps. Lee Schank, president of Case/Rixon in Silver Spring, Md., asserts "4,800 is an unnecessary stopping point." Dial-up modems operating at 9,600 bps require both echo-cancelling techniques and equipment that is expensive to develop and manufacture. "The cost differential between 4,800 and 9,600 modems is insignificant. [That is,] if you're going to invest in the VLSI technology and software programs that automatically adjust the modem's data output according to the changing line conditions."

Full-duplex modems operating at 9,600 bps for dial-up applications will make their first appearance by the end of the year, says Hank Morgan, product line manager at Gandalf, in Wheeling, Ill. He adds that international standards for 9,600-bps, full-duplex modems were adopted by the CCITT only in April 1984. "By the end of '85, somebody will be delivering 9,600, full-duplex equipment."

ATTIS quickly made its presence felt in numerous segments of the modem market once it

9600 BIT/SEC DIAL-UP PC MODEM CARD

- FOR IBM PC/XT/AT & COMPATIBLES
- OEM PRICING AS LOW AS \$995.00
- WORKS OVER SWITCHED (DIAL) NETWORK
- AUTO DIAL/ANSWER AUTO FALLBACK
- SYNCHRONOUS

• *"You have a great product. I believe it has the potential to start a PC communications revolution."*

K.R., First Data Management

• *"The installation and programming of your modems were very simple, allowing almost anyone to program or install them."*

A.K., Varian Corp.

• *"There were absolutely no communications failures of any kind during our testing period."*

D.H., First National Bank & Trust Co. of Oklahoma City

GAMMA TECHNOLOGY, INC.
(415) 856-7421

2452 EMBARCADERO WAY • PALO ALTO, CA 94303 • TWX: 910-373-1296

CIRCLE NO. 11 ON INQUIRY CARD

**This Publication
is available in
Microform.**

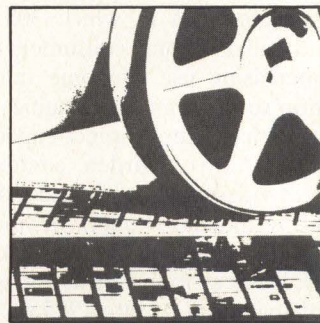

**University Microfilms
International**

Please send additional information

for _____
Name _____
Institution _____
Street _____
City _____
State _____ Zip _____

300 North Zeeb Road
Dept. P.R.
Ann Arbor, Mi. 48106

CIRCLE NO. 12 ON INQUIRY CARD

MINI-MICRO SYSTEMS/February 15, 1985

Fujitsu modems have lots of ways to fit into your plans.

At Fujitsu, we offer a diverse line of OEM high-speed stand-alone modems and boards to bring out the best in your product designs. Now you can take advantage of the industry's most technologically advanced features. Like operating speeds up to 14,400 bits per second. Like powerful automatic equalizers that minimize the effects of line interference. And versatility that makes our modems compatible with any type of equipment.

As one of the world's largest data communications suppliers, we know that our growth depends upon how

well our products help your company grow. That's why we continue to develop OEM products on the cutting edge of technology. And every product we make is backed by the Fujitsu name — recognized worldwide as a leader in data communications products.

For more information, contact us today. We'll be delighted to show you how our products fit into your plans.

Fujitsu America, Inc. • Data Communications Division • 3055 Orchard Dr
San Jose, CA 95134 • (408) 946-8777



CIRCLE NO. 13 ON INQUIRY CARD

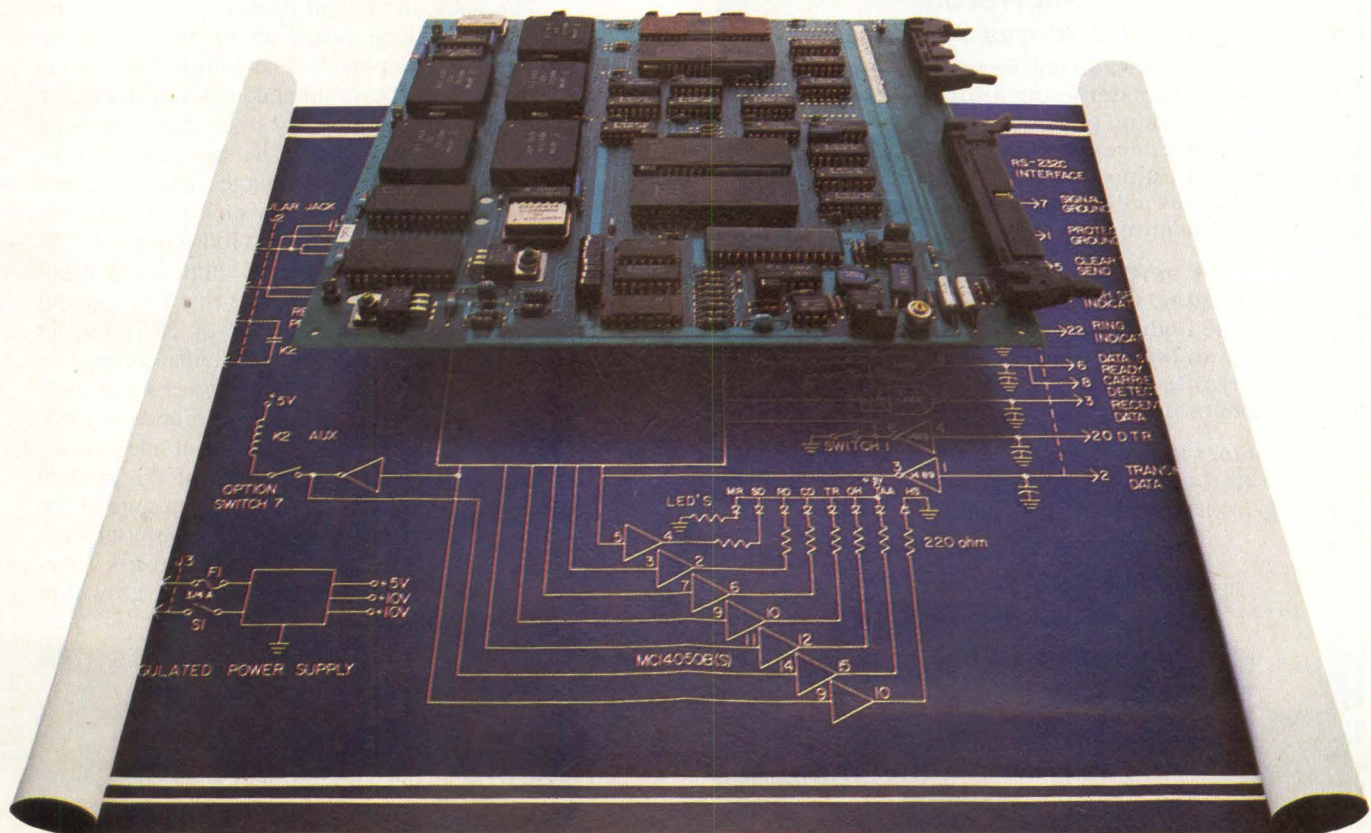
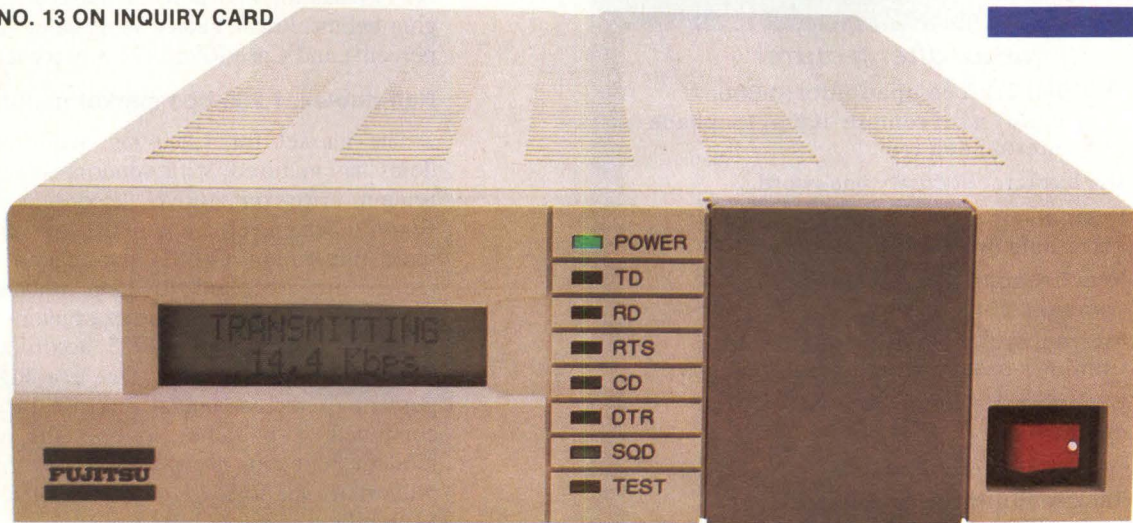

See us at **INTERFACE '85** March 4-7 • Near front entrance at space 1100

BYTCOM MODEMS

FOR YOUR PCs
OR DATA TERMINALS



Feature after feature!

- Full Bell 212A compatibility (0-300, 1200 baud) with remote digital loopback and internal self test.
- 16 character security password.
- Designed for use with either "dumb" terminals or PCs.
- Synchronous and Asynchronous transmission modes.
- Internal storage of nine names and numbers to forty characters in length.
- Exclusive ability to "Reboot" your computer.
- User-friendly help menu.
- Rack mountable version available.

Free "SuperScout"

Communications Software

This unique \$249 software value allows data file transfer using a sophisticated error checking protocol. It also gives automatic access to COMPUSERVE™, Western Union's EASYLINK™ and 13 other data bases without individual sign-up or monthly minimum fees.

A very broad warranty!

The 212AD is a proved-in-service product whose high reliability allows Bytcom to offer an *Immediate Unit Replacement Warranty* within the first two years of ownership. Details on request.

Contact Bytcom for additional information and name of your nearest distributor.

Software Supplied By
BUSINESS COMPUTER NETWORK
SUPERSCOUT™

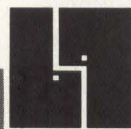

BYTCOM

2169 Francisco Blvd. Suite H,
San Rafael, CA 94901

(415) 485-0700 (800) 227-3254 (outside CA).

CIRCLE NO. 14 ON INQUIRY CARD

MODEMS

was unfettered in 1982 to supply telecommunications hardware and computer equipment. According to the most recent IDC estimates, ATTIS captured, by the end of 1983, 16 percent of the market for modems operating at 0 to 600 bps. In this low-speed market, ATTIS ranked just 0.7 percent behind leader Hayes Microcomputer Products. ATTIS is the leader in the 1,200-bps, half-duplex segment, with 22.2 percent of the market. At 1,200 bps, full-duplex, ATTIS has an 11.7-percent market share, lagging behind Racal-Vadic, Sunnyvale, Calif., (31 percent) and Case/Rixon (22.3 percent).

Half-duplex, 1,200-bps market mature

The market for 1,200-bps, half-duplex modems has matured, with vendors scrambling to remain price-competitive, according to Case/Rixon's Schank. Increased use of very large-scale integration (VLSI) manufacturing techniques are expected to help reduce "plain vanilla" 1,200-bps, half-duplex modems to prices under \$200 by the end of 1985, according to The Yankee Group's estimates. Due to a sluggish 7.2-percent predicted annual increase in demand, combined with falling prices, the value of modem shipments is expected to rise from \$40.9 million in 1983 to \$42.8 million in 1988, a paltry \$1.9 million increase over five years.

The slack, in the half-duplex market segment, however, will be taken up by the 1,200-bps, full-duplex equipment. The full-duplex version allows data to be simultaneously transmitted in both directions on two- rather than four-wire telephone circuits. With dial-up business telephone and private-line charges going up, and technological developments such as VLSI techniques bringing costs down, full-duplex, 1,200-bps modems are receiving an enthusiastic reception from users. IDC estimates that this segment will grow at an annual rate of 25.7 percent through 1988. From 268,600 units shipped in 1983, 1200-bps, full-duplex modems are projected to jump to 845,000 units shipped in 1988.

Overall, industry analysts continue to see healthy growth in most sectors of the modem market during the next four years, in spite of the increasing availability of digital-transmission lines in local and wide-area data networks. According to IDC's market projections, growth in unit shipments is expected to average 18.7 percent annually through 1988. □

Interest Quotient (Circle One)
High 450 Medium 451 Low 452

“Tell me what you want in a custom OEM modem, and I’ll give it to you in 60 days.”

Weldon S. Bankston
National OEM Sales Manager
CTS DATACOMM



“I’ll give you Computer Aided Design capability.”

Using Computer Aided Design equipment our engineering staff can create the custom electrical interfaces or unique board configurations you demand. Then, within 60 days, you’ll have a prototype modem. Standard RS232C, TTL or custom interfaces are also available.

“I’ll give you a high performance, quality modem at a competitive price in whatever quantities you need.”

CTS’ signal processor/micro processor approach to modem design is so unique and reliable we’ve applied for a patent with over fifty claims. And years of experience in OEM support manufacturing with the latest in sophisticated production equipment insures your modem will be of the highest quality and at the best price and on time.

“And I’ll give you 89 years of reliability and stability.”

CTS Corporation has supplied the communications industries since 1896 when it began manufacturing wooden, hand cranked, wall mounted telephones for rural communities. Today, for your current modem needs, we can give you design flexibility, experienced engineers, advanced technology, reliability and a competitive price. And all within 60 days. Call Weldon at 408-356-3868 or write us and find out more about what you can get.

CTS[®]

DATACOMM Products Division
6900 Shady Oak Rd.
Eden Prairie, MN 55344
612-941-9100

New to the industry since 1896.

CIRCLE NO. 15 ON INQUIRY CARD

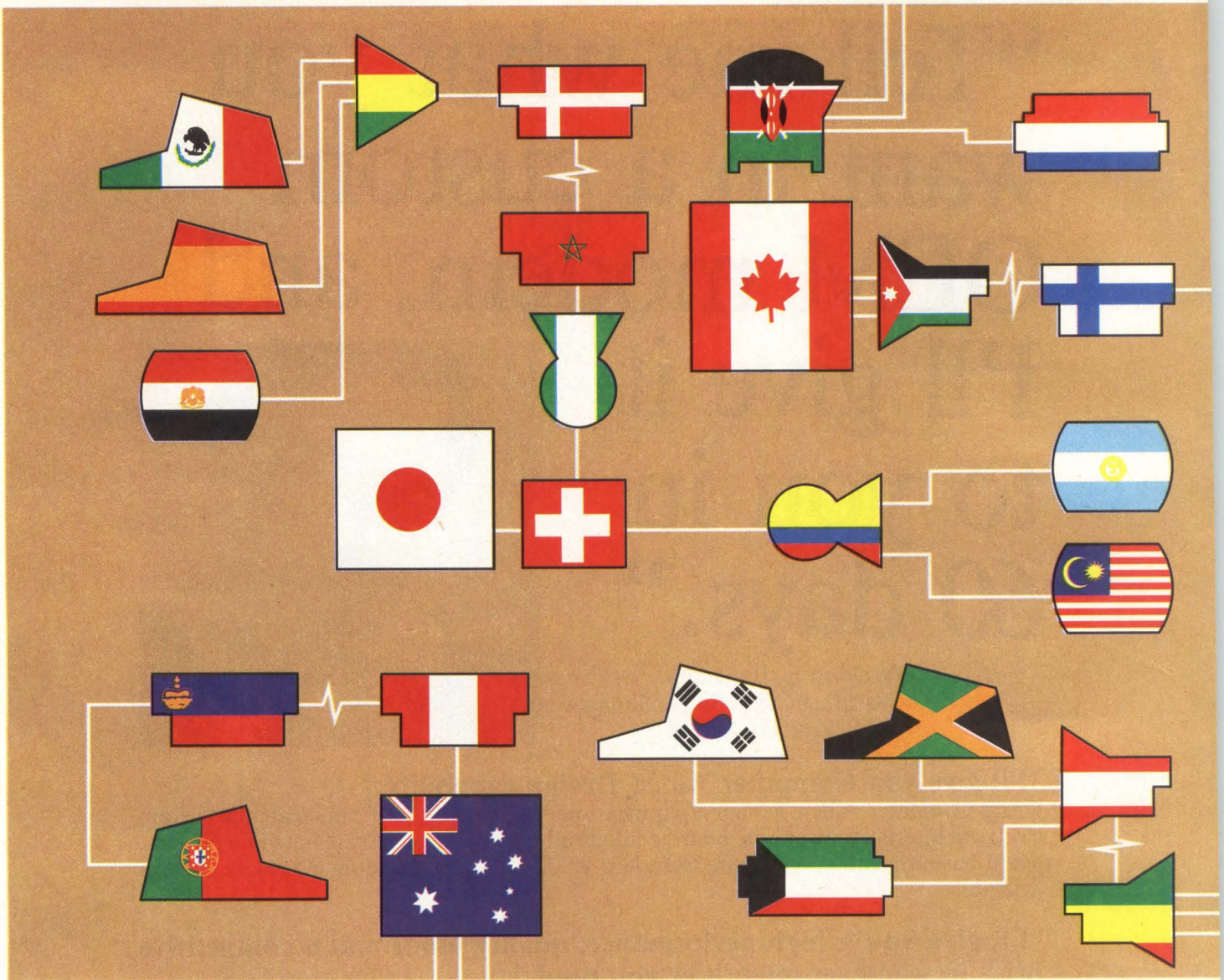

AFTER BREAKING COMMUNICATION WE'RE MORE THAN

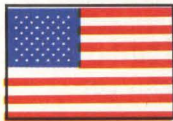

We're CASE.

There's a world of difference between our perspective on data communications, and everybody else's.

Starting with the world itself. We've successfully established and serviced networks in over 60 different countries. We help computers communicate in places where even the people don't speak the same language.

We're number one in Europe, and a dominant datacomm force throughout the world — with major facilities in Australia, Canada, Hong Kong, the United Kingdom and the United States.

And now, after joining forces with RIXON, we're even stronger. We're ready to break communication barriers in all 50 states.

There's good reason for our success. And it goes beyond breaking geographic barriers. We

USA CASE RIXON Communications, Inc., Columbia, MD. Sales Telephone: (301) 381-CASE; Factory Telephone: (301) 622-2121; TLX: 89-8347
Major Regional Offices: Atlanta (404) 446-8680 • Boston (617) 879-1021 • Chicago (312) 850-7299
Dallas (214) 631-6366 • Denver (303) 770-0813 • Los Angeles (714) 898-7737 • New York (212) 594-0370 • Philadelphia (215) 688-8750
San Francisco (415) 570-6777 • St. Louis (314) 946-4721

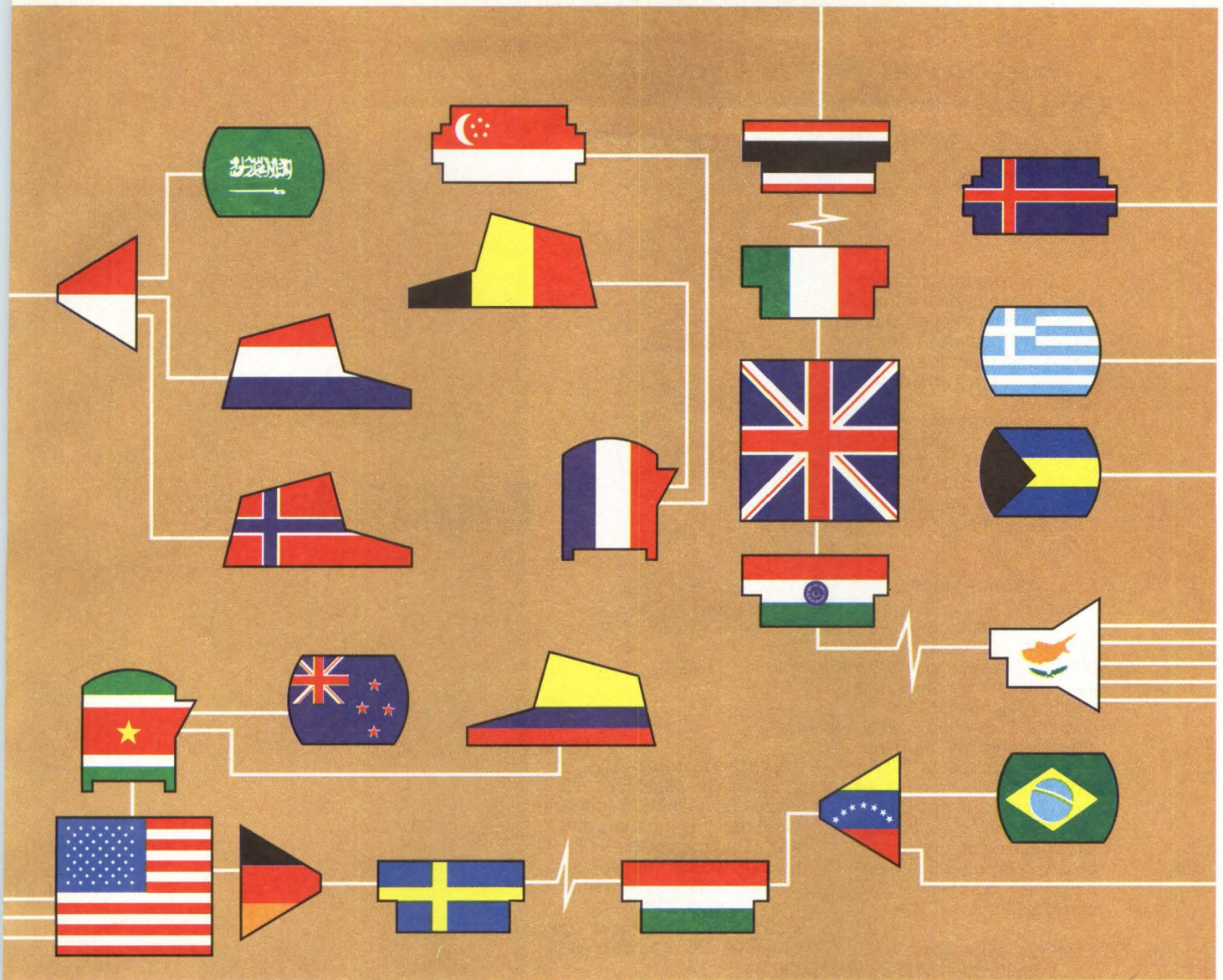

BARRIERS IN SIXTY COUNTRIES, READY FOR FIFTY STATES

break time barriers as well. Because we build *future-proof* products.

These include some of the best modems, multiplexers, communications processors, electronic mail and network diagnostics in the business.

Every one of those products is designed to accommodate the inevitable changes the future will bring to your company — around the office, around the country, around the world.

Find out how to build a network that has no limits — in time or geography. Call us toll-free in the United States at 800-422-2724. Or make a direct call to any of the offices listed below.

CASE
Future-Proof
Data Communications™

UK & Europe World Headquarters: Computer And Systems Engineering plc, England, Telephone: 0923-33500, TLX: 923325
 Canada CASE RIXON Communications Ltd, Ontario, Telephone: (416) 495-0333
 Australia CASE Communication Systems Ltd, Telephone: (02) 451-6655, TLX: 72982
 Hong Kong CASE Hong Kong, TLX: 86870

What do you get when you cross 1200 baud, free on-line time, and extra features at a price Hayes can't match?

Shopping for a modem doesn't have to be a riddle. A tedious sifting through claims and counterclaims. A quest for the best that raises more questions than it answers.

The new MultiModem, from Multi-Tech Systems, gives you the right answers from the start. The answers to all your questions about what a first-rate intelligent modem should do for you.

Data Transmission Speed?

The MultiModem gives you a choice—either 1200 or 300 bits per second. 1200 for fast, efficient communications and lower long-distance charges. Like when you're downloading data from the corporate computer, or swapping files with a friend across the country. 300 bps for your less demanding applications, like checking out bulletin boards, playing games, or having on-line keyboard conversations.

Free On-Line Time?

With the MultiModem you get CompuServe's DemoPak—a free two-hour demonstration of their service, and up to seven more free hours of on-line time if you subscribe. You also get a \$50 usage credit from NewsNet, a service which lets you tap into 150 different specialized business newsletters.

Intelligence? Extra Features?

Of course, the MultiModem automatically dials, answers, and disconnects. But it does a few extra things too, things the Hayes Smartmodem 1200™ doesn't. Like recognize dial tones and busy signals, so the MultiModem will automatically redial, or automatically try a different number. And it remembers phone numbers too, up to six of them, in its battery-backed memory.

Trademarks—MultiModem, MultiCom PC, Multi-Tech Systems, Inc.—CompuServe, CompuServe Information Services, an H & R Block company—NewsNet, NewsNet, Inc.—Smartmodem, Hayes Microcomputer Products, Inc.—Crosstalk, Microsoft, Inc.—Data Capture, Southeastern Software—PC-Talk III, Freeware/The Headlands Press

Hayes-compatibility?

Yes, the MultiModem is Hayes-compatible. (Most software requires modems that are.) That means the MultiModem will run with popular communications programs like Crosstalk XVI, Data Capture, PC-Talk III, our own MultiCom PC, and dozens of others.

What About Price?

At \$549, the MultiModem retails for \$150 less than the Smartmodem™. You get Hayes-compatibility and so much more—for so much less.

What do you get when you cross all these things? The MultiModem. From Multi-Tech Systems—a company that's been making top-quality modems for over thirteen years.

Isn't this the answer you've been looking for?

For the name of your local distributor, write to **Multi-Tech Systems, Inc.** 82 Second Avenue S.E. New Brighton, Minnesota 55112. Or call us at (612) 631-3550.

MultiModem.



MultiTech Systems

The right answer every time.

VOICE GRADE DDD MODEMS

TABLE 1

DDD MODEMS
TABLE 1

Company Model	Data rate (bps)	Modulation method	Transmission mode	Synchronization	Calling mode	Diagnostics	Price (\$)	Notes, features, options
AMERICAN MICROSYSTEMS INC. (AMI)								
S35212/S35213	1200	FSK, DPSK	half, full duplex	asynch/synch	auto dial/ auto answer	local digital and analog loopback, remote digital loopback		Bell 103-, 212A-compatible
ANCHOR AUTOMATION								
Signalman XIII	300, 1200	FSK	full duplex	asynch	auto dial/ auto answer		399 (Q1)	Bell 103-, 212A-compatible
Signalman Express	300, 1200	PSK	half, full duplex	asynch	auto dial/ auto answer	local and remote analog loopback, self-test	439 (Q1)	Bell 103-, 212A-compatible
Volkmodem	300, 1200	FSK	full duplex	asynch	auto dial/ auto answer		299 (Q1)	Bell 103-, 212A-compatible
APPLE COMPUTER INC.								
Apple Modem 1200	0-300, 1200	FSK, PSK	half, full duplex	asynch	auto dial/ auto answer	local analog loopback	495	Bell 212A-compatible
AST RESEARCH								
REACH!	1200	DPSK	half, full duplex	asynch	auto dial/ auto answer	local analog and remote digital loopback, self-test	549 (Q1)	includes CROSSTALK XVI software; Bell 103-, 113-, 212A-compatible; board-level modem plugs into IBM PC
BIZCOMP								
PC IntelliModem	300, 1200		half, full duplex	asynch	auto dial/ auto answer		499 (Q1)	includes software, Bell 212A-compatible, board-level modem plugs into IBM PC
IntelliModem XL	300, 1200		half, full duplex	asynch	auto dial/ auto answer		549 (Q1)	includes software; Bell 212A-, Hayes-compatible; board-level modem plugs into IBM PC
BYTCOM								
212AD	0-300, 1200	FSK, PSK	full duplex	asynch/synch	auto dial/ auto answer	local and remote, digital and analog loopback, self-test	495 (Q1)	Bell 103-, 113-, 212-compatible; includes BCN software
CASE RIXON COMMUNICATIONS INC.								
R2424	1200, 2400	QAM	full duplex	asynch/synch	manual orig./ auto answer	local digital and analog loopback, remote digital loopback, self-test	1,295 (Q1)	Bell 212A-compatible
R2424 Auto Diatek	1200, 2400	QAM	full duplex	asynch/synch	auto dial/ auto answer	local digital and analog loopback, remote digital loopback, self-test	1,395 (Q1)	Bell 212A-compatible
R96	9600	QAM	full duplex	synch		local and remote, digital and analog loopback, self-test	2,595 (Q1)	CCITT V.29-compatible, point-to-point
R96FP	9600	QAM	full duplex	synch		local and remote, digital and analog loopback, self-test	2,995 (Q1)	Bell 212A-compatible, point-to-point or polling
Executive 212	300-1200	FSK, PSK	full duplex	asynch	auto dial/ auto answer			Bell-compatible
PC212A	300-1200	FSK, PSK	full duplex	asynch	auto dial/ auto answer			Bell-compatible
R212A	300-1200		full duplex	asynch/synch	auto dial/ auto answer	local and remote digital loopback		Bell-compatible
R212 Intelligent	1200	FSK	half duplex	asynch	manual orig./ auto answer	local analog and remote digital loopback		Bell 103-, 113-, 212A-compatible
RV.22 bis	1200-2400	PSK, QAM	full duplex	synch		remote digital and analog loopback, self-test		Bell 202-compatible

**VOICE GRADE DDD MODEMS
TABLE 1**

Company Model	Data rate (bps)	Modulation method	Transmission mode	Synchronization	Calling mode	Diagnostics	Price (\$)	Notes, features, options
T202S	0-1200	FSK	half duplex	asynch	auto dial/ auto answer	local and remote, digital and analog loopback, self-test		Bell-compatible
T202T	0-1800	FSK	half, full duplex	asynch		local and remote, digital and analog loopback, self-test		Bell 202-compatible
TA201C	2400		half, full duplex	synch	auto dial/ auto answer	local and remote, digital and analog loopback, self-test		Bell 2018-, 201C-, 801-compatible
CERMETEK MICROELECTRONICS INC.								
Cermetek 1200 MODEM	110, 300, 1200	FSK, PSK	half, full duplex	asynch/synch	auto dial/ auto answer	local and remote, digital and analog loopback, self-test	595 (Q1)	voice/data switch; electronic call; progress on screen or speaker; Bell 103-, 212A-, Hayes-compatible
Cermetek 1200PC MODEM	110, 300, 1200	FSK, PSK	half, full duplex	asynch	auto dial/ auto answer	local and remote, digital and analog loopback, self-test	495 (Q1)	includes CROSSTALK communication software; board-level modem plugs into IBM PC/XT; Bell 103-, 212A-, Hayes-compatible
Cermetek Security MODEM	110, 300, 1200	FSK, PSK	half, full duplex	asynch/synch	auto dial/ auto answer	local and remote, digital and analog loopback, self-test	695 (Q1)	includes CROSSTALK communication software; board-level modem plugs into IBM PC/XT; Bell 103-, 212A-, Hayes-compatible
CODEX CORP.								
2231	1200, 2400	DPSK, QAM	half, full duplex	asynch/synch	manual orig./ auto answer	local digital and analog loopback, remote digital loopback, self-test	995 (Q1)	Bell 212-compatible
2232	1200, 2400	DPSK, QAM	full duplex	asynch/synch	auto dial/ auto answer	local digital and analog loopback, remote digital loopback, self-test	1,195 (Q1)	Bell 212-compatible
COHERENT COMMUNICATIONS SYSTEMS CORP.								
DAM-SD	1200		half, full duplex	asynch/synch	manual orig./ manual answer	local digital loopback, self-test	482 (Q1)	
COMDESIGN INC.								
TM-2400	2400	DPSK	full duplex	synch	auto dial/ auto answer	local digital and analog loopback, self-test	750 (Q1)	Bell 201B-compatible
TM-4800	4800	DPSK	full duplex	synch	auto dial/ auto answer	local digital and analog loopback, self-test	1,750 (Q1)	Bell 208A-, B-compatible
TM-9600	9600	DPSK	full duplex	synch	auto dial/ auto answer	local digital and analog loopback, remote digital loopback, self-test	2,750 (Q1)	CCITT V.29-compatible
COMREX INTERNATIONAL								
CR-212	1200	FSK, DPSK	full duplex	asynch	auto dial/ auto answer	local digital and analog loopback, self-test		Bell 103-, 212A-, Racal-Vadic-compatible; board-level modem plugs into Epson QX 10
CONCORD DATA SYSTEMS INC.								
CDS 224	1200, 2400	DPSK, QAM	full duplex	asynch/synch	manual orig./ auto answer	local and remote, digital and analog loopback, self-test	845 (Q1)	Bell 212-, 2224-compatible
CDS 224 AD	1200, 2400	DPSK, QAM	full duplex	asynch/synch	auto dial/ auto answer	local and remote, digital and analog loopback, self-test	995 (Q1)	compatible with most software packages; Bell 212-, 2224-compatible
CDS 224 ARQ	2400	QAM	full duplex	asynch	manual orig./ auto answer	local and remote, digital and analog loopback, self-test	1,295 (Q1)	includes error correction

**VOICE GRADE DDD MODEMS
TABLE 1**

**DDD MODEMS
TABLE 1**

<i>Company Model</i>	<i>Data rate (bps)</i>	<i>Modulation method</i>	<i>Transmission mode</i>	<i>Synchronization</i>	<i>Calling mode</i>	<i>Diagnostics</i>	<i>Price (\$)</i>	<i>Notes, features, options</i>
CDS 224 ARQ/AD	2400	QAM	full duplex	asynch	auto dial/ auto answer	local and remote, digital and analog loopback, self-test	1,395 (Q1)	includes error correction
CDS 224 SD	2400	QAM	full duplex	asynch	auto dial/ auto answer	local and remote, digital and analog loopback, self-test	1,695 (Q1)	includes 3-port statistical multiplexer, error correction
V.22	300, 600, 1200	DPSK	full duplex	asynch/synch	manual orig./ auto answer	local digital and analog loopback, remote digital loopback, self-test	795 (Q1); 710 (Q100)	Bell 212A-compatible
V.22 Bis	1200, 2400	DPSK, QAM	full duplex	asynch/synch	manual orig./ auto answer	local digital and analog loopback, remote digital loopback, self-test	845 (Q1); 785 (Q100)	Bell 212A-, 224-compatible; international version of CDS 224
V.22 Bis A/D	1200, 2400	DPSK, QAM	full duplex	asynch/synch	auto dial/ auto answer	local digital and analog loopback, remote digital loopback, self-test	995 (Q1); 895 (Q100)	Bell 212A-, 224-compatible; international version of CDS 224 A/D
DATABIT INC.								
SA212		PSK	full duplex	asynch/synch	auto dial/ auto answer	local and remote, digital and analog loopback, self-test		Bell 212A-compatible
DATA COMMUNICATIONS BROKERS INC.								
PL 48	4800	QAM	full duplex	synch		local digital and analog loopback, self-test	1,300 (Q1)	external power supply, CCITT V.27-compatible
PL 9.6	9600	QAM	full duplex	synch		local digital and analog loopback, self-test	1,600 (Q1)	external power supply, CCITT V.29-compatible
PL 14.4	14.4K	QAM	full duplex	synch		local digital and analog loopback, self-test	2,900 (Q1)	external power supply, CCITT V.29-compatible
DATAGRAM CORP.								
D224	2400	PSK	full duplex	asynch/synch	auto dial/ auto answer		995 (Q1)	CCITT V.22 bis-compatible
D4800	4800	DSPK, QAM	full duplex	synch		local and remote, digital and analog loopback, self-test	1,395 (Q1)	CCITT V.27-compatible
D9600	9600	DSPK, QAM	full duplex	synch		local and remote, digital and analog loopback, self-test	1,995 (Q1)	CCITT V.29-compatible
D14400	14.4K	DPSK, QAM	full duplex	synch		local and remote, digital and analog loopback, self-test	4,895 (Q1)	
DATEC								
212S		DPSK	full duplex	asynch/synch	auto dial/ auto answer	local and remote, digital and analog loopback, self-test	695 (Q1)	Bell-, Hayes-compatible
DATEC 212A	300, 1200	FSK, DPSK	half, full duplex	asynch/synch	auto dial/ auto answer	local and remote, digital and analog loopback, self-test	595 (Q1)	Bell 103-, 113-, 212A-compatible
DATEC 212R/ACU	300, 1200	FSK, DPSK	half, full duplex	asynch/synch	auto dial/ auto answer	local and remote, digital and analog loopback, self-test	695 (Q1)	Bell 103-, 113-, 212A-compatible
PAL 212	0-300, 1200	FSK, DPSK	full duplex	asynch	auto dial/ auto answer	local analog loopback	497 (Q1)	Bell 103-, Hayes 113-, 212A-compatible
PAL Plus		FSK, DPSK	full duplex	asynch	auto dial/ auto answer	self-test	595 (Q1)	includes CROSSTALK XVI software; board-level modem plugs into IBM PC/XT; Bell 103-, 113-, 212A-, Hayes-compatible
DEVELCON ELECTRONICS INC.								
201B	2400	PSK	full duplex	synch		local analog loopback, remote digital loopback, self-test		anti-streaming, Bell 201B-compatible

**VOICE GRADE DDD MODEMS
TABLE 1**

<i>Company Model</i>	<i>Data rate (bps)</i>	<i>Modulation method</i>	<i>Transmission mode</i>	<i>Synchronization</i>	<i>Calling mode</i>	<i>Diagnostics</i>	<i>Price (\$)</i>	<i>Notes, features, options</i>
201BR	2400	PSK	full duplex	synch		local analog loopback, remote digital loopback, self-test		anti-streaming
208 A/B	4800	PSK	half, full duplex	synch	auto answer	local digital loopback		anti-streaming, adaptive equalization, Bell 208A-/B-compatible
208 A/BR	4800	PSK	half, full duplex	synch	auto answer	local digital loopback		anti-streaming, adaptive equalization, Bell 208A-/B-compatible
212RD	1200	PSK	full duplex	asynch/synch	auto answer	local digital and analog loopback, remote digital loopback, self-test		own power supply; Bell 103-, 212A-compatible
2X212	1200	PSK	full duplex	asynch	auto dial/ auto answer	local digital and analog loopback, remote digital loopback, self-test		2 channels; Bell 103-, 212A-compatible
6212	1200	PSK	full duplex	asynch/synch	auto dial/ auto answer	local analog loopback		microprocessor controlled, programmable hang-up code, speed dialing, Bell-212 compatible
7212	1200	PSK	full duplex	asynch/synch	manual orig./ auto answer	local digital and analog loopback, remote digital loopback, self-test		Bell 103-, 212A-compatible
9202C	1200	PSK	full duplex	asynch				9 status leads, Bell 202-compatible
9600 A/B	4800, 7200, 9600	QAM	half, full duplex	synch	auto answer	local digital and loopback, remote digital and analog loopback, self-test		automatic adaptive equalization
9600 A/BR	7200, 9600	QAM	half, full duplex	synch	auto answer	local and remote, digital and analog loopback, self-test		automatic adaptive equalization
DIGITAL COMMUNICATIONS ASSOCIATES INC. (DCA)								
DCA 910	1200, 2400	PSK	half, full duplex	synch		local and remote, digital and analog loopback, self-test	1,095 (Q1)	LCD display; CCITT V.26-, V.26 bis-compatible
DCA 911	1200, 2400	PSK, QAM	full duplex	asynch/synch	auto dial/ auto answer	local and remote, digital and analog loopback, self-test	1,195 (Q1)	Bell 212A-, CCITT V.22-compatible
DCA 920	2400, 4800	PSK	half, full duplex	synch		local and remote, digital and analog loopback, self-test	1,695 (Q1)	eye pattern generator, CCITT V.27 bis-/ter-compatible
DCA 930	2400, 4800, 7200, 9600	QAM	half, full duplex	synch		local and remote, digital and analog loopback, self-test	2,795 (Q1)	LCD display, built-in 4-channel multiplexer, CCITT V.29-compatible
DCA 940	4800, 7200, 9600, 14.4K	QAM	half, full duplex	synch		local and remote, digital and analog loopback, self-test	5,395 (Q1)	LCD display, eye-pattern generator, built-in 6-channel multiplexer, CCITT V.29-compatible
GAMMA TECHNOLOGY								
FAXT-96	9600	QAM	half duplex	synch	auto dial/ auto answer	self-test	1,995 (Q1); 1,195 (Q100)	CCITT V.29-, V.27 ter-compatible; board-level modem plugs into IBM PC
GANDALF DATA INC.								
SAM 201	1200, 2400	DPSK	half, full duplex	asynch/synch	manual orig./ auto answer	local digital and analog loopback, remote digital loopback, self-test	725 (Q1)	CCITT V.26-, Bell 201C-compatible; rackmount (\$650)
SAM 212A	300, 1200	DPSK	full duplex	asynch/synch	auto dial/ auto answer	local digital and analog loopback, remote digital loopback, self-test	618 (Q1)	Bell 103-, 113-, 212A-compatible

VOICE GRADE DDD MODEMS
TABLE 1

Company Model	Data rate (bps)	Modulation method	Transmission mode	Synchronization	Calling mode	Diagnostics	Price (\$)	Notes, features, options
SM 9600	9600	QAM	full duplex	synch		local analog loop-back, remote digital and analog loop-back, self-test	2,800 (Q1)	rackmount; CCITT V.24-, V.28-compatible; opt. integral 4-channel multiplexer
GENERAL DATACOMM INDUSTRIES INC.								
202-9D	1200, 1800	FSK	half, full duplex	asynch		local digital and analog loopback	420 (Q1)	WECO 202C-, 202D-compatible
212A/ED	300, 1200	FSK	full duplex	asynch	manual orig./ auto answer	local digital and analog loopback, self-test	575 (Q1)	Bell 103-, 113-, 212A-compatible; digital adaptive equalizer, standalone
212A/SL	300, 1200	FSK, DPSK	full duplex	asynch	manual orig./ auto answer	local digital and analog loopback, self-test	445 (Q1)	Bell 103-, 113-, 212A-compatible; standalone
DC 201C	1200, 2400	DPSK	half, full duplex	synch	auto dial/ auto answer	local digital and analog loopback, remote digital loop-back, self-test	895 (Q1)	Bell 201B-/C-, CCITT V.26 bis-compatible; rackmount (\$805)
DC 201C-K	1200, 2400	DPSK	half duplex	synch	auto dial/ auto answer	local analog loop-back, self-test	795 (Q1)	Bell 201C-, CCITT V.26 bis-compatible; rackmount (\$705); opt. asynch
DC 201-7	1200, 2400	DPSK	half, full duplex	synch		local digital and analog loopback, remote digital loop-back, self-test	695 (Q1)	Bell 201C-compatible, rackmount (\$605); opt. signal-quality monitor
DC 202S/T	1200, 1800	FSK	half, full duplex	asynch	auto dial/ manual answer	local digital and analog loopback, self-test	535 (Q1)	Bell 202-compatible, rackmount (\$445)
DC 202T	1200, 1800	FSK	half, full duplex	asynch		local digital and analog loopback, self-test	485 (Q1)	Bell 202T-compatible, rackmount (\$395)
DC 208B/A	4800	DPSK	half, full duplex	synch	manual orig./ auto answer	local digital and analog loopback, remote digital loop-back, self-test	1,695 (Q1)	Bell 208A-/B-compatible, rackmount
DC 212A/L	300, 1200	FSK, DPSK	full duplex	asynch/synch	manual orig./ auto answer	local digital and analog loopback, remote digital loop-back, self-test	675 (Q1)	Bell 103-, 113-, 212A-compatible; rackmount (\$585)
DC 2400ASM	300, 600, 1200, 1800, 2400	DPSK	full duplex	asynch/synch		local digital and analog loopback	825 (Q1)	Bell 201B-/C-compatible, rackmount (\$135), point-to-point or polling
DC 2412	1200, 2400	QAM	full duplex	asynch/synch	auto dial/ auto answer	local digital and analog loopback, remote digital loop-back, self-test	1,195 (Q1)	Bell 212A-, CCITT V.22-, V.22 bis-compatible; stores 30 numbers, rackmount (\$1,105)
DC 4800	4800	DSPK	half, full duplex	asynch/synch		local and remote, digital and analog loopback, self-test	1,495 (Q1)	Bell 208A-compatible, point-to-point or polling
DC 4800S	4800	DPSK	half duplex	asynch/synch	auto dial/ auto answer	local analog loop-back, self-test	1,595 (Q1)	Bell 208-compatible; opt. asynch operation
DC 4827	4800	DPSK	half, full duplex	asynch/synch		local and remote, digital and analog loopback, self-test	1,495 (Q1)	CCITT V.27 bis-compatible
DC 9600	4800, 7200, 9600	QAM	half, full duplex	synch		local digital and analog loopback, self-test	1,995 (Q1)	CCITT V.29-compatible
DC 9600EP	4800, 7200, 9600	QAM	half, full duplex	synch		local digital and analog loopback, remote digital loop-back, self-test	2,150 (Q1)	CCITT V.29-compatible
DC 9600QPS	4800, 7200, 9600	QAM	half, full duplex	synch		local digital and analog loopback, self-test	2,295 (Q1)	CCITT V.29-compatible

DDD MODEMS
TABLE 1

**VOICE GRADE DDD MODEMS
TABLE 1**

Company Model	Data rate (bps)	Modulation method	Transmission mode	Synchronization	Calling mode	Diagnostics	Price (\$)	Notes, features, options
DC 14400	1200, 9600, 14.4K	QAM	full duplex	synch		local and remote, digital and analog loopback, self-test	5,995 (Q1)	CCITT V.29-compatible, point-to-point
GDC 9604	2400, 4800, 7200, 9600	QAM	half, full duplex	synch		local and remote, digital and analog loopback, self-test	2,895 (Q1)	CCITT V.29-compatible
GOULD AMI								
S3521312	1200	DPSK	half, full duplex	asynch/synch	auto dial/ auto answer	local digital and analog loopback, remote digital loopback, self-test		2-chip CMOS modem; Bell 103-, 212A-compatible; board-level modem plugs into any computer terminal or bus
HALCYON								
H414	14.4K	QAM	half, full duplex	synch		local and remote, digital and analog loopback, self-test	4,995 (Q1); 3,995 (Q100)	CCITT V.29-compatible; opt. trellis modulation, 6-port TDM multiplexer
H424	1200, 2400	PSK, QAM	half, full duplex	asynch/synch	auto dial/ auto answer	local and remote, digital and analog loopback, self-test	795 (Q1); 595 (Q100)	CCITT V.22- bis-, Bell 212A-compatible
H448	4800	PSK	half, full duplex	synch		local and remote, digital and analog loopback, self-test	2,055 (Q1); 1,250 (Q100)	CCITT V.27 bis-/ter-compatible; opt. trellis modulation, 6-port TDM multiplexer
H496	9600	QAM	half, full duplex	synch		local and remote, digital and analog loopback, self-test	1,495 (Q1); 995 (Q100)	CCITT V.29-compatible; opt. trellis modulation, 4-port TDM multiplexer
HAYES MICROCOMPTUER PRODUCTS INC.								
Smartmodem 1200	0-300, 1200	PSK	half, full duplex	asynch	auto dial/ auto answer	local analog loopback, self-test	699 (Q1)	Bell 212A-compatible
Smartmodem 1200B	0-300, 1200	PSK	half, full duplex	asynch	auto dial/ auto answer	local analog loopback, self-test	539 (Q1)	Bell 212A-compatible, board-level modem plugs into IBM and compatibles
INFINET INC.								
CM2020	1200	FSK	half duplex	asynch	auto dial/ auto answer	self-test	275 (Q1)	Bell 202-compatible
M1200	1200	FSK	half duplex	asynch	manual orig./ manual answer	local digital and analog loopback, self-test	525 (Q1)	Bell 202-compatible
M2400		PSK	half, full duplex	synch	manual orig./ manual answer	local digital and analog loopback, self-test	725 (Q1)	Bell 201-compatible
INFOTRON SYSTEMS CORP.								
DL212B	300, 1200	FSK, PSK	full duplex	asynch/synch	auto answer	local and remote, digital and analog loopback	825 (Q1); 715 (Q100)	Bell 103-, 212A-compatible
DMS/Triple	300, 1200	FSK, PSK	full duplex	asynch/synch	auto answer	local and remote, digital and analog loopback	855 (Q1); 770 (Q100)	Bell 103-, 212A-, Vadic VA3400-compatible
INMAC/DATACOM DIV.								
1970	4800	PSK	half, full duplex	synch	manual orig./ manual answer	local and remote, digital and analog loopback, self-test	1,750 (Q1)	Bell 208A-/B-compatible
1971	4800, 7200, 9600	PSK	half, full duplex	synch	manual orig./ manual answer	local and remote, digital and analog loopback, self-test	1,995 (Q1)	CCITT V.29-, V.27-compatible
8044	0-300, 1200	FSK, PSK	half, full duplex	asynch	auto dial/ auto answer		499 (Q1)	includes CROSSTALK XVI software; Bell 103-, 113-, 212A-compatible; board-level modem plugs into IBM PC or compatible
8071	1200	PSK	half, full duplex	asynch	auto dial/ auto answer	local and remote, digital and analog loopback, self-test	295 (Q1)	Bel 103-, 113-compatible

**VOICE GRADE DDD MODEMS
TABLE 1**

**DDD MODEMS
TABLE 1**

Company Model	Data rate (bps)	Modulation method	Transmission mode	Synchronization	Calling mode	Diagnostics	Price (\$)	Notes, features, options
8077	0-300, 1200	FSK, PSK	half, full duplex	asynch	auto dial/ auto answer		449 (Q1)	Bell 103-, 212A-compatible
8079	1200, 2400	PSK, DPSK	full duplex	asynch/synch	manual orig./ auto answer	local and remote, digital and analog loopback, self-test	995 (Q1)	Bell 212-compatible
KINEX CORP.								
48/208AB	2400, 4800	DPSK	half, full duplex	synch	manual orig./ auto answer	local and remote, digital and analog loopback, self-test	1,700 (Q1)	Bell 208A-/B-, 212-compatible; auto adaptive equalizer, rackmount (\$1.650)
2400/FDX	1200, 2400	DPSK	half, full duplex	synch	manual orig./ auto answer	local and remote, digital and analog loopback, self-test	1,695 (Q1)	CCITT V.26 ter-compatible, auto adaptive equalizer
4800/27	2400, 4800	QAM	half, full duplex	synch	manual orig./ auto answer	local and remote, digital and analog loopback, self-test	2,100 (Q1)	CCITT V.27 bis-ter-compatible, auto adaptive equalizer
9600/29	4800, 7200, 9600	QAM	half, full duplex	synch	manual orig./ manual answer	local digital and analog loopback, self-test	2,700 (Q1)	CCITT V.29-compatible, rackmount
9600/DCM	4800, 7200, 9600, 14.4K	QAM	full duplex	synch	manual orig./ manual answer	local digital and analog loopback, remote analog loopback, self-test	3,650 (Q1)	CCITT V.29-compatible
9600/FP	4800, 7200, 9600	QAM	half, full duplex	synch		local and remote, digital and analog loopback, self-test	3,350 (Q1)	
9600/M	4800, 7200, 9600	QAM	half, full duplex	synch	manual orig./ manual answer	local digital and analog loopback, remote digital loopback, self-test	3,650 (Q1)	CCITT V.29-compatible
14,400/M Data Express	9600, 12K, 14.4K	QAM	half, full duplex	synch		local and remote, digital and analog loopback, self-test	4,295 (Q1)	CCITT V.29-compatible, multiport
SAB 284	up to 19.2K		half, full duplex	asynch/synch		local digital and analog loopback, remote analog loopback, self-test	345 (Q1)	
LEXICON CORP.								
LEX-15	1200	FSK	half duplex	asynch	manual orig.		325 (Q1)	Bell 202S-compatible; opt. TTL interface
LEX-15B	1200	FSK	half duplex	asynch	manual orig.		395 (Q1)	Bell 202S-compatible, built-in battery pack; opt. TTL interface
MICOM SYSTEMS INC.								
M3012	0-300, 1200	FSK, DPSK	full duplex	asynch/synch	manual orig./ auto answer	local digital and analog loopback, remote digital loopback, self-test	495 (Q1)	standalone; Bell 103-, 212-compatible
M3012+	0-300, 1200	FSK, DPSK	full duplex	asynch/synch	auto dial/ auto answer	local digital and analog loopback, remote digital loopback, self-test	595 (Q1)	standalone; Bell 103-, 212-compatible
M3012T+		FSK, DPSK	full duplex	asynch/synch	auto dial/ auto answer	local digital and analog loopback, remote digital loopback, self-test	795 (Q1)	standalone; Bell 103-, 212-, Vadic VA3400-compatible
M3012TA	0-300, 1200	FSK, DPSK	full duplex	asynch/synch	auto answer	local digital and analog loopback, remote digital loopback, self-test	695 (Q1)	Bell 103-, 212-, Vadic VA3400-compatible
M3024	1200, 2400	DPSK, QAM	full duplex	asynch/synch	manual orig./ auto answer	local digital and analog loopback, remote digital loopback, self-test	795 (Q1)	standalone; Bell 212-, CCITT V.22 bis-compatible

VOICE GRADE DDD MODEMS
TABLE 1

Company Model	Data rate (bps)	Modulation method	Transmission mode	Synchronization	Calling mode	Diagnostics	Price (\$)	Notes, features, options
M3024+	1200, 2400	DPSK, QAM	full duplex	asynch/synch	auto dial/ auto answer	local digital and analog loopback, remote digital loopback, self-test	895 (Q1)	standalone; Bell 212-, CCITT V.22 bis-compatible
M3212	0-300, 1200	FSK, DPSK	full duplex	asynch/synch	manual orig./ auto answer	local digital and analog loopback, remote digital loopback, self-test	445 (Q1)	Bell 103-, 212-compatible
M3212+		FSK, DPSK	full duplex	asynch/synch	auto dial/ auto answer	local digital and analog loopback, remote digital loopback, self-test	545 (Q1)	Bell 103-, 212-compatible
M3212T+	0-300, 1200	FSK, DPSK	full duplex	asynch/synch	auto dial/ auto answer	local digital and analog loopback, remote digital loopback, self-test	745 (Q1)	Bell 103-, 212-, Vadic VA3400-compatible
M3212TA	0-300, 1200	FSK, DPSK	full duplex	asynch/synch	auto answer	local digital and analog loopback, remote digital loopback, self-test	645 (Q1)	Bell 103-, 212-, Vadic VA3400-compatible
M3224	1200, 2400	DPSK, QAM	full duplex	asynch/synch	manual orig./ auto answer	local digital and analog loopback, remote digital loopback, self-test	745 (Q1)	Bell 212-, CCITT V.22 bis-compatible
M3224+	1200, 2400	DPSK, QAM	full duplex	asynch/synch	auto dial/ auto answer	local digital and analog loopback, remote digital loopback, self-test	845 (Q1)	Bell 212-, CCITT V.22 bis-compatible
MICROPLEX INC.								
VersaCom 212	1200	DPSK	full duplex	asynch/synch	auto dial/ auto answer	local digital and analog loopback	289 (Q1); 150 (Q100)	Bell 212-compatible; opt. headset
VersaCom 1200	1200	FSK	half duplex	asynch	auto dial/ auto answer	local digital and analog loopback	187 (Q1); 125 (Q100)	Bell 202-compatible; opt. headset
MULTI-TECH SYSTEMS INC.								
MT212AD	300, 1200	FSK, QAM	half, full duplex	asynch/synch	auto dial/ auto answer	local analog loopback, remote digital loopback	695 (Q1)	Hayes Smartmodem 1200-, Bell 103-, 113-, 212A-compatible
MT224AD	300, 1200, 2400	FSK, DPSK, QAM	half, full duplex	asynch/synch		local digital and analog loopback, remote digital loopback	949 (Q1)	Hayes Smartmodem 1200-, CCITT V.22 bis-, Bell 103-, 113-, 212A-compatible
MultiModem	300, 1200	FSK, DPSK	half, full duplex	asynch	auto dial/ auto answer	local digital and analog loopback	549 (Q1)	Hayes Smartmodem-, Bell 103-, 113-, 212A-compatible
MultiModem PC	300, 1200	FSK, DPSK	half, full duplex	asynch	auto dial/ auto answer	local analog loopback, self-test	549 (Q1)	Hayes Smartmodem 1200B-, Bell 103-, 113-, 212A-compatible; board-level modem plugs into IBM PC
MultiModem 212C	1200	DPSK	half, full duplex	asynch/synch	auto dial/ auto answer	local analog loopback, self-test	550 (Q1)	board-level modem plugs into IBM PC, menu driven firmware
NCR COMTEN INC.								
7164-0100	4800	DPSK	half, full duplex	synch		local analog loopback, remote digital loopback, self-test	3,700 (Q1); 2,553 (Q100)	IBM 3864-1-compatible
7164-0200	4800	DPSK	half duplex	synch	auto dial/ auto answer	local analog loopback, remote digital loopback, self-test	3,850 (Q1); 2,657 (Q100)	IBM 3864-2-compatible
7165-0100	9600	DPSK, QAM	half, full duplex	synch		local analog loopback, remote digital loopback, self-test	5,800 (Q1); 4,002 (Q100)	IBM 3865-1-compatible
7165-0200	9600	DPSK, QAM	half, full duplex	synch		local analog loopback, remote digital loopback, self-test	5,800 (Q1); 4,002 (Q100)	IBM 3865-2-compatible

**VOICE GRADE DDD MODEMS
TABLE 1**

DDD MODEMS
TABLE 1

Company Model	Data rate (bps)	Modulation method	Transmission mode	Synchronization	Calling mode	Diagnostics	Price (\$)	Notes, features, options
NOVATION INC.								
CAT COMMUNICATION SYSTEM	0-300, 1200	FSK, PSK	half, full duplex	asynch	auto dial/ auto answer	local digital and analog loopback, remote digital loopback, self-test	499 (Q1)	Bell 103-, 212A-, Hayes-compatible; includes software
CAT COMMUNICATION SYSTEM	0-300, 1200	FSK, PSK	half, full duplex	asynch	auto dial/ auto answer	local digital and analog loopback, remote digital loopback, self-test	499 (Q1)	Hayes-, Bell 103-, 212A-compatible; board-level modem plugs into IBM PC/XT and compatibles; includes software
212 APPLE-CAT	0-300, 1200	FSK, PSK	half, full duplex	asynch	auto dial/ auto answer	self-test	595 (Q1)	Bell 103-, 202-, 212A-compatible; board-level modem plugs into Apple II, II+, IIc; includes software
PARADYNE CORP.								
BTA 1200	1200	DPSK	half, full duplex	asynch	auto dial/ auto answer		655 (Q1)	Bell 212A-compatible
ISP-48	2400, 4800	DPSK	half duplex	synch	manual orig./ auto answer	local digital and analog loopback, self-test		CCITT V.27-compatible
Challenger 24/24	300, 600, 1200, 2400	DPSK	half, full duplex	asynch/synch	auto dial/ auto answer	local and remote, digital and analog loopback, self-test	1,100 (Q1)	Bell 103-, 212-, CCITT V.22-, V.22 bis-compatible
Challenger 12000	1200, 9600	QAM	half duplex	synch	manual orig./ auto answer	local digital and analog loopback, self-test		
PENRIL DATACOMM								
AD300/1200	1200	PSK	full duplex	asynch/synch	auto dial/ auto answer	local digital and analog loopback, remote digital loopback, self-test	650 (Q1)	Bell 212A-compatible; opt. security access system, rackmount
2024	1200, 2400	PSK	full duplex	asynch/synch	auto dial/ auto answer	local digital and analog loopback, remote digital loopback, self-test	895 (Q1)	Bell 212A-, 224-compatible
2127	2400, 4800	DPSK	half duplex	synch	manual orig./ auto answer	local analog loopback, self-test	1,695 (Q1)	CCITT V.27-compatible
8201-DN	1200, 2400	PSK	half duplex	synch	manual orig./ auto answer	local analog loopback, self-test	795 (Q1)	Bell 201C-compatible
RACAL-MILGO INFORMATION SYSTEMS								
24 LSI Mark II	2400	DPSK	half, full duplex	synch	manual orig./ auto answer		1,450 (Q1)	point-to-point, central site version; CCITT V.26B-, Bell 201B-, C-compatible
1200 Mark II	0-1200	FSK	half, full duplex	asynch/synch		local and remote, digital and analog loopback, self-test	1,150 (Q1)	rackmount
CMS 12	0-1200	FSK	half, full duplex	asynch/synch		local and remote, digital and analog loopback, self-test	1,900 (Q1)	central site version
CMS 24	2400	DPSK	half, full duplex	synch		local and remote, digital and analog loopback, self-test	2,200 (Q1)	standalone, central site version; Bell 201 B-/C-, CCITT V.26B-compatible
Com-Link III	1200-19.2K	delay modulation	half, full duplex	synch		local and remote, digital and analog loopback, self-test	920 (Q1)	central site version, 9 selectable operating speeds, Bell Pub 43401-compatible
Com-Links IIIS	1200-19.2K	delay modulation	half, full duplex	synch		local and remote, digital and analog loopback, self-test	1,520 (Q19)	9 selectable operating speeds, 43401-compatible
Mark 48	4800-9600	QAM	half, full duplex	synch		local and remote, digital and analog loopback, self-test	1,515 (Q1)	polled multidrop applications; CCITT V.27 bis-, Omnimode-, Racal-Milgo MPS series-, Federal Standard 1006-compatible

**VOICE GRADE DDD MODEMS
TABLE 1**

Company Model	Data rate (bps)	Modulation method	Transmission mode	Synchronization	Calling mode	Diagnostics	Price (\$)	Notes, features, options
Mark 96	4800-9600	QAM	half, full duplex	synch			2,500 (Q1)	polled multidrop applications; CCITT V.29-, Omnimode-, Racal-Milgo MPS series-, Federal Standard 1007-compatible
Omnimode 14.4	14.4K	DPSK, QAM, conventional coded modulation	full duplex	synch		local and remote, digital and analog loopback, self-test	10,000 (Q1); 9,500 (Q100)	central site version
Omnimode 48	2400, 4800	DPSK	full duplex	synch		local and remote, digital and analog loopback, self-test	2,450 (Q1); 2,400 (Q100)	central site version, multiport 2/4 port, CCITT V.27 bis-compatible
Omnimode 48 D	2400, 4800	DPSK	half, full duplex	synch	auto dial/ auto answer	local and remote, digital and analog loopback, self-test	2,450 (Q1); 2,400 (Q100)	central site version, multiport 2/4 port, CCITT V.27 bis-/ta Ter Comp-compatible
Omnimode 96	9600	DPSK, QAM	full duplex	synch		local and remote, digital and analog loopback, self-test	4,150 (Q1); 4,100 (Q100)	central site version; CCITT V.29-, Racal-Milgo MPS 9601-, 9269-compatible
RACAL-VADIC								
212LC		DPSK	full duplex	asynch	manual orig./ auto answer	local digital and analog loopback, self-test	395 (Q1)	Bell 103-, 212-compatible
212PA		DPSK	full duplex	asynch	auto dial/ auto answer	local digital and analog loopback, remote digital loopback, self-test	695 (Q1)	Bell 103-, 212-compatible
1200PC		DPSK	full duplex	asynch	auto dial/ auto answer	local digital and analog loopback, remote digital loopback	545 (Q1)	Bell 103-, 212-compatible; George software available, board-level modem plugs into IBM-compatible
1200V		DPSK	full duplex	asynch	auto dial/ auto answer	local digital and analog loopback, remote digital loopback	595 (Q1)	Bell 103-, 212-compatible
2400PC		QAM	full duplex	asynch/synch	auto dial/ auto answer	local digital and analog loopback, remote digital loopback	795 (Q1)	CCITT V.22 bis-, Bell 103-, 212-compatible; George software available; board-level modem plugs into IBM PC
2400V		QAM	full duplex	asynch/synch	auto dial/ auto answer	local and remote, digital and analog loopback, self-test	795 (Q1)	alternate voice/data; internal speaker; CCITT V.22 bis-, Bell 103-, 212-compatible
TANDY CORP./RADIO SHACK								
DC2212	300, 1200	FSK, PSK	full duplex	asynch	auto dial/ auto answer	local analog loopback	399 (Q1)	Bell 212A-compatible
TECH-NEL DATA PRODUCTS LTD.								
Viewdata	75, 1200	FSK	full duplex	asynch	auto dial/ auto answer		295 (Q1); 207 (Q100)	rackmount, Viewdata-compatible
V22 Data Modem	1200	PSK	full duplex	asynch/synch	auto dial/ auto answer	local and remote, digital and analog loopback, self-test	665 (Q1); 532 (Q100)	rackmount, error correction, CCITT V.23-compatible
V23 Data Modem	1200	FSK	half duplex	asynch	auto dial/ auto answer		287 (Q1); 229 (Q100)	rackmount, CCITT V.23-compatible
V26 Data Modem	2400	DPSK	half, full duplex	asynch/synch	auto dial/ auto answer	local and remote, digital and analog loopback, self-test	427 (Q1); 341 (Q100)	CCITT V.26-compatible, rackmount
TECMAR INC.								
Modem 1200	1200	FSK	full duplex	asynch	auto dial/ auto answer		695 (Q1)	board-level modem plugs into IBM PC; Bell 103-, 212A-compatible
TEK-COM CORP.								
202T/202S	0-1800	FSK	half, full duplex	asynch	manual orig./ auto answer	local and remote digital loopback, self-test	225 (Q1); 150 (Q100)	Bell 202T-/C-/D-/F-/R-/S-compatible; rackmount

**VOICE GRADE DDD MODEMS
TABLE 1**

**DDD MODEMS
TABLE 1**

Company Model	Data rate (bps)	Modulation method	Transmission mode	Synchronization	Calling mode	Diagnostics	Price (\$)	Notes, features, options
212A	300, 1200	FSK, PSK	half, full duplex	asynch	manual orig./ auto answer	local digital and analog loopback, remote digital loopback, self-test	330 (Q1); 270 (Q100)	rackmount, Bell 212A-compatible
TIMEPLEX INC.								
AIM 2400	2400	DPSK	full duplex	synch		local and remote, digital and analog loopback, self-test	1,050 (Q1)	board-level modem plugs into Timeplex Microplexer family, Bell 3002-compatible, rackmount
AIM 4800	4800	DPSK	full duplex	synch		local and remote, digital and analog loopback, self-test	1,850 (Q1)	board-level modem plugs into Timeplex Microplexer family, Bell 3002-compatible, rackmount
AIM 9600	9600	QAM	full duplex	synch		local and remote, digital and analog loopback, self-test	2,000 (Q1)	board-level modem plugs into Timeplex Microplexer family, rackmount
TRANSEND CORP.								
IPI 1200	1200	FSK, DPSK	full duplex	asynch	auto dial/ auto answer	local analog loopback, self-test	599 (Q1); 367 (Q100)	voice/data switching, electronic mail software; Bell 103-, 113-, 212A-, Hayes-compatible; board level modem plugs into IBM PC and compatibles
IPX 1200	1200	FSK, DPSK	full duplex	asynch	auto dial/ auto answer	local analog loopback, self-test	674 (Q1); 413 (Q100)	voice/data switching, electronic mail software; Bell 103-, 113-, 212A-, Hayes-compatible
TRENDA DATA CORP.								
Aia Modem	1200	PSK	half, full duplex	asynch	auto dial/ auto answer	self-test		Hayes-, Bell 212A-compatible; includes support software, security passwords and dial-back
TRI-DATA								
OZ 533	1200		half, full duplex	asynch	auto dial/ auto answer	local and remote, digital and analog loopback, self-test	750 (Q1); 515 (Q100)	Bell 212-compatible
U.S. ROBOTICS								
Auto Dial 212A	1200	PSK	half, full duplex	asynch	auto dial/ auto answer	self-test	599 (Q1)	Bell 212A-compatible, automatic error detection
UNIVERSAL DATA SYSTEMS								
201C	2400	DPSK	half duplex	synch	manual orig./ auto answer	local analog loopback, self-test	775 (Q1)	Bell 201-compatible, full-duplex on 4-wire private line, includes test-pattern generator
202LP	0-1200	FSK	half duplex	asynch	manual orig./ auto answer		195 (Q1)	Bell 202-compatible, operates from telephone line current
202S	0-1200	FSK	half duplex	asynch	manual orig./ auto answer	local analog loopback, self-test	475 (Q1)	Bell 202-compatible, includes test-pattern generator
202S/5	0-1200	FSK	half duplex	asynch	manual orig./ auto answer	local analog loopback, self-test	550 (Q1)	Bell 202-compatible
202S/D	0-1200	FSK	half duplex	asynch	auto dial/ auto answer			Bell 202-compatible
202S/SS	0-1200	FSK	half duplex	synch	manual orig./ auto answer	local analog loopback, self-test	550 (Q1)	Bell 202-compatible, includes test-pattern generator
202SLP	0-1200	FSK	half duplex	asynch	manual orig./ auto answer		245 (Q1)	Bell 202-compatible, operates from telephone line current

**VOICE GRADE DDD MODEMS
TABLE 1**

Company Model	Data rate (bps)	Modulation method	Transmission mode	Synchronization	Calling mode	Diagnostics	Price (\$)	Notes, features, options
202S/150	0-1200	FSK	half duplex	asynch	manual orig./ auto answer	local analog loopback, self-test	620 (Q1)	Bell 202-compatible
208A/B	4800	DPSK	half duplex	synch	manual orig./ auto answer	local digital and analog loopback, self-test	1,750 (Q1)	Bell 208-compatible, includes test-pattern generator
212A	0-300, 1200	FSK, PSK	full duplex	asynch/synch	manual orig./ auto answer	local and remote, digital and analog loopback, self-test	595 (Q1)	Bell 212A-compatible
212A/D	0-300, 1200	FSK, PSK	full duplex	asynch/synch	auto dial/ auto answer	local and remote, digital and analog loopback, self-test	645 (Q1)	Bell 212A-compatible
212A LP	0-300, 1200	FSK, PSK	full duplex	asynch	manual orig./ auto answer			Bell 212A-compatible, operates from telephone line current
212LP	0-300, 1200	FSK, PSK	full duplex	asynch	manual orig./ manual answer		345 (Q1)	Bell 212A-compatible, operates from telephone line current
224	1200, 2400	QAM	full duplex	asynch/synch	manual orig./ auto answer	local digital and analog loopback, remote digital loopback, self-test	995 (Q1)	Bell 212A-, CCITT V.22 bis-compatible; diagnostics
9600A/B	4800, 7200, 9600	QAM	half duplex	synch	manual orig./ auto answer	local digital and analog loopback, self-test	1,995 (Q1)	UDS 9600A-/B-compatible, simulates full duplex operation
FASTALK 1200	0-300, 1200	FSK, PSK	full duplex	asynch	auto dial/ auto answer	local analog loopback, self-test		Bell 212A-, Hayes-compatible; includes IBM PC software
VEN-TEL INC.								
ALD-1				asynch		local digital and analog loopback	205 (Q1); 155 (Q100)	
ALD-2				asynch		local digital and analog loopback	250 (Q1); 185 (Q100)	
ALD-3				asynch		local digital and analog loopback	275 (Q1); 190 (Q100)	
EC212PLUS	1200	FSK, PSK	full duplex	asynch	auto dial	local digital and analog loopback, remote digital loopback, self-test	549 (Q1); 410 (Q100)	Bell 103-, 113-, 212-compatible
EC1200-31	1200	FSK, PSK	full duplex	asynch	auto dial	local digital and analog loopback, remote digital loopback, self-test	549 (Q1); 410 (Q100)	Bell 103-, 113-, 212-compatible
EC1200-32	1200	FSK, PSK	full duplex	asynch	auto dial/ auto answer	local analog loopback, remote digital loopback	499 (Q1); 370 (Q100)	Bell 212A-compatible
MD201-1	2400	DPSK	half, full duplex	synch	auto dial/ auto answer	self-test	730 (Q1); 550 (Q100)	Bell 201C-compatible
MD201-2E	2400	DPSK	half, full duplex	synch	auto dial/ auto answer	self-test	800 (Q1); 600 (Q100)	Bell 201C-compatible
MD201-3	2400	DPSK	half, full duplex	synch		self-test	605 (Q1); 460 (Q100)	Bell 201B-compatible
MD201-4E	2400	DPSK	half, full duplex	synch		local digital loopback, self-test	675 (Q1); 510 (Q100)	Bell 201B-compatible
MD212-5E	1200	FSK, PSK	full duplex	asynch	auto dial/ auto answer	local digital and analog loopback, remote digital loopback, self-test	625 (Q1); 465 (Q100)	Bell 212A-compatible
MD212-7E SECURITY PLUS	1200	FSK, PSK	full duplex	asynch	auto dial/ auto answer	local digital and analog loopback, self-test	675 (Q1); 510 (Q100)	Bell 212A-compatible
MD212-8 SECURITY PLUS	1200	FSK, PSK	full duplex	asynch	auto dial/ auto answer	local digital and analog loopback, self-test	625 (Q1); 465 (Q100)	Bell 212A-compatible

**VOICE GRADE DDD MODEMS
TABLE 1**

**DDD MODEMS
TABLE 1**

Company Model	Data rate (bps)	Modulation method	Transmission mode	Synchronization	Calling mode	Diagnostics	Price (\$)	Notes, features, options
PCM1202	1200	FSK	full duplex	asynch	auto dial/ auto answer		499 (Q1); 370 (Q100)	Bell 212A-compatible
PCM-XT HALF CARD	1200	FSK	half, full duplex	asynch	auto dial/ auto answer	local digital and analog loopback	549 (Q1); 410 (Q100)	board-level modem plugs into IBM PC and compati- bles; Bell 103- 212A-compatible
PCMH-150P	1200		half, full duplex		auto dial/ auto answer	local digital and analog loopback, remote digital loop- back, self-test	425 (Q1); 310 (Q100)	board-level modem plugs into Hewlett-Packard 150; Bell 103-, 212A-compatible
SLD-1				synch		local analog loopback	380 (Q1); 285 (Q100)	
SLD-3E				synch		local analog loopback	450 (Q1); 340 (Q100)	
202-1	0-1200	FSK	half, full duplex	asynch	manual orig./ auto dial	local digital and analog loopback	310 (Q1); 240 (Q100)	Bell 202S-compatible
202-2E	0-1200	FSK	half, full duplex	asynch	auto dial	local digital and analog loopback	380 (Q1); 285 (Q100)	Bell 202S-compatible
202-5	0-1200	FSK	half, full duplex	asynch	auto dial	local digital and analog loopback	280 (Q1); 190 (Q100)	Bell 202T-compatible
212-6	1200	FSK, PSK	full duplex	asynch	auto dial/ auto answer	local digital and analog loopback, remote digital loop- back, self-test	585 (Q1); 435 (Q100)	Bell 212A-compatible
2026E	0-1200		half, full duplex	asynch	auto dial	local digital and analog loopback	350 (Q1); 250 (Q100)	Bell 202T-compatible
VISIONARY ELECTRONICS								
VISIONARY 1200	1200	FSK, PSK	half, full duplex	asynch	auto dial/ auto answer		795 (Q1)	Bell 212A-compatible, con- verts word processor to sophisticated telex
WANG LABORATORIES INC.								
WA3451	0-1200	FSK	half, full duplex	asynch/synch	manual orig./ auto answer	local and remote digital loopback, self-test	1,050 (Q1); 850 (Q100)	switchable data rates; Bell 103-, 212-; Vadic 3400-compatible
WOLFDATA INC.								
WD-212-II	1200	FSK, PSK	full duplex	asynch	auto dial/ auto answer	local digital loop- back, self-test		Bell 272A-compatible, board- level modem plugs into IBM PC; opt. external serial port
WD-212-X	1200	FSK, PSK	full duplex	asynch/synch	auto dial/ auto answer	local digital loopback		CCITT V.22-, X.25-, Bell 212A-compatible; board-level modem plugs into IBM PC

Information was solicited but not received from the following manufacturers:

- Black Box Corp.
- Bo-Sherrel Co. Inc.
- Digital Equipment Corp.
- IBM Corp.
- Rockwell International Semiconductor/Products Div.

For information on their products, consult the Supplementary Directory of Manufacturers on page 113.

WE SOLVE THESE PROBLEMS EVERY DAY.

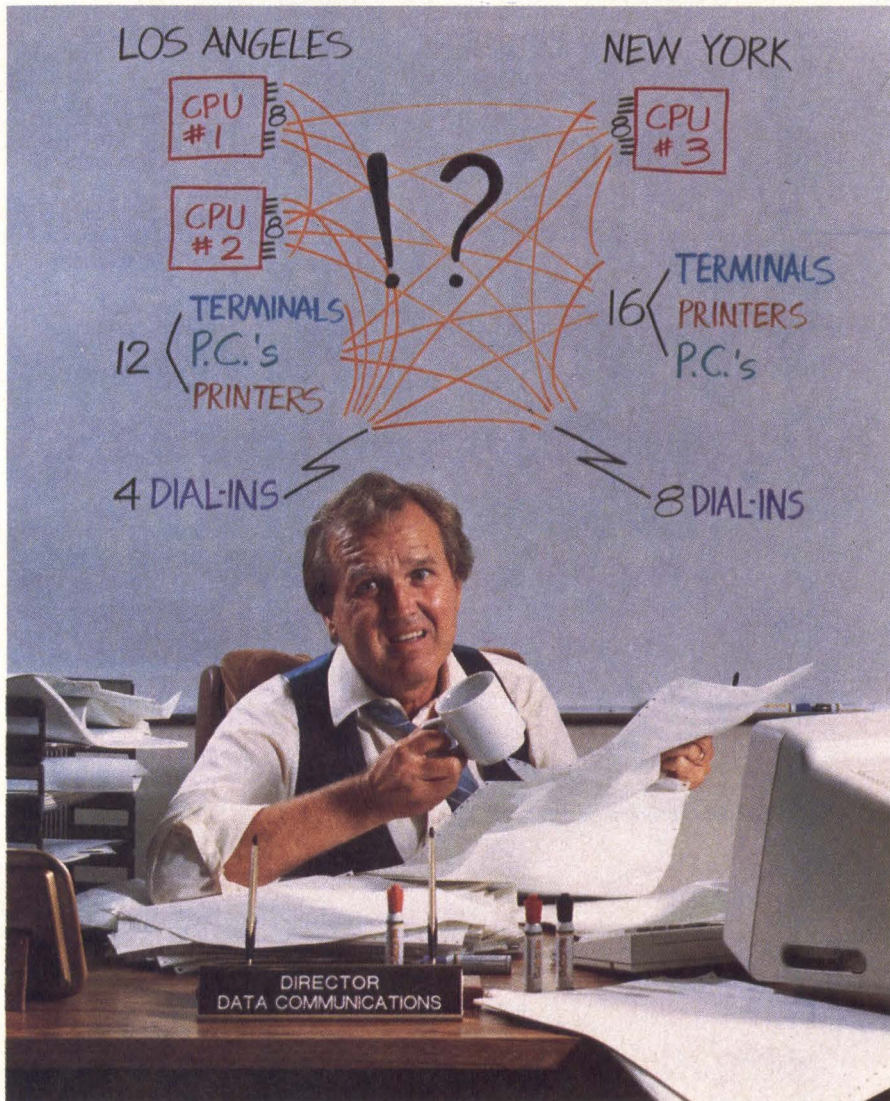

Struggling to tie everything and everyone together without sacrificing performance or breaking the bank? Let your stat mux do it for you!



Get everyone into the act with the new TS-600 Series.

If increasing demand for computer ports and distributed resources has your system in a stranglehold, there's no limit to the breathing space you could enjoy with the TS-600 Switching Stat Mux.

The newest addition to the ComDesign family of networking products, the TS-600 Series provide the same cost savings and network control as the popular TC-500A. With no limit to the number of users who may contend for any available ports, the TS-600 offers all the features of a data switch, port contention unit and intelligent statistical multiplexer in one.

When used individually, a TS-600 acts as a port selector and front-end processor, permitting local resource sharing. Connected in pairs, TS-600's become the central point of control in a powerful transparent switching network, concentrating up to 32 devices over a single communications link. ComDesign's modular hardware and firmware plan allows for easy network expansion and access to the latest software developments.

The TS-600 Series multiplexers are designed for ease of use, and are available with integral 4800 or 9600 bps modems. For more information on the new TS Series or for help with any data comm problem, call us. Toll-free (800) 235-6935, or in California (800) 368-8092.

ComDesign
Leaders in Data Communications

751 South Kellogg Avenue
Goleta, California 93117

MULTIPLEXERS KEEP PACE WITH DATACOMM NEEDS

As communications networks increase in size and complexity, multiplexers are meeting the challenges of proliferating terminals, rising datacomm costs and T1, X.25 and satellite links

Jesse Victor, Associate Editor

As the proverbial terminal begins to appear on every proverbial desktop, spiraling data-transmission costs threaten the proverbial bottom line of every company, laboratory, factory or university faced with growing communications needs. Terminals and PCs have to be connected to host computers in the next building, another city or on another coast. Installing cabling for each device or leasing multiple dedicated telephone lines can be expensive for five terminals and prohibitive for 500.

Multiplexers' key role in reducing datacomm line costs has thus assumed added importance in today's complex communications networks. Technologically, too, they have kept pace with users' needs by adding functionality—integrating functions previously performed by other types of datacomm equipment. Low-end and mid-range units are providing data-switching and control capabilities, diagnostics, integrated modems and are performing rudimentary network management. High-end devices are beginning to take over some of the functions of communications processors and meeting the demands for greater bandwidth and higher transmission speeds by furnishing packet assembly/disassembly (PAD) for X.25 packet-switching systems and by interfacing with satellite links.

Communications planners and system integrators are increasingly turning to multiplexers capable of interfacing with AT&T Communications' T1 digital lines as a cost-effective means of integrating large numbers of remote terminals

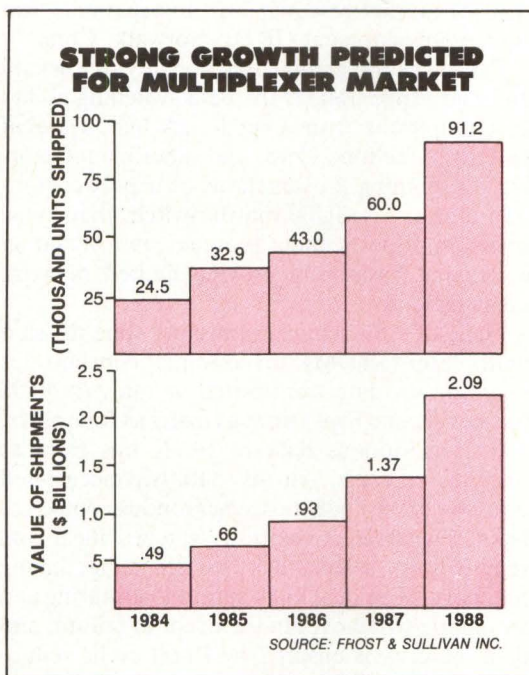

and providing quality voice, data, facsimile and live-action TV conferencing services. T1 multiplexer developers are also looking ahead to emerging standards and the challenges of future integrated services digital networks (ISDNs).

Multiplexers adding capabilities

"Multiplexers and modems are starting to be commodity products," asserts Richard Amster, director of data communications research at The Yankee Group, Boston. "Vendors are trying to

“The normal interval we quote customers is a nine-to-12-month delay for installing a T1 line”

differentiate their products by integrating functions, increasing capabilities and putting in some network-management features.”

“Smaller vendors, particularly, are adding more features at the same product price,” adds Laura Schlafly, product line manager for multiplexers at Racal-Milgo, Fort Lauderdale, Fla. “Data-communications functions are merging,” agrees Pat Jordan, senior consultant at Datapro Research Corp., Delran, N.J. “They all now have their niche but are starting to overlap. High-end multiplexers, for example, are merging into front-end processors.”

The greater capabilities of today’s multiplexers and upward integration of functions is good news for end users and system integrators who need datacomm systems that perform a greater variety of services at lower cost. “The [multiplexer] buyer has a much greater variety of very sophisticated equipment at reasonable prices than ever before,” emphasizes Ken Bosomworth, president of market research firm International Resource Development (IRD), Norwalk, Conn.

Typical of the greater functionality of low-end and mid-range units is the data-switching ability of multiplexers from Comdesign Inc., Gandalf Data Inc., Teltone Corp. and other manufacturers. Combining the functions of a port-contention unit and a digital matrix switch, they allow selection of ports under program control and on a demand basis, and provide limited network management.

Gandalf’s Switchmux statistical time-division multiplexer (STDM), for example, concentrates synchronous data transmitted at rates to 4,800 bits per second (bps) from as many as four users, and asynchronous data to 19.2K bps from as many as 16 users. All this data is concentrated into one or two 64K-bps synchronous composite links. Dynamic contention switches local and remote users, selectable by service name, among free ports. The dual links permit loadsharing and automatic switchover in the event of failure, and data integrity is ensured by 16-bit cyclic redundancy check (CRC) error detection with automatic request for repeat (ARQ) of transmitted data. Passwords protect access to the system console and user ports. System-management functions include usage and error statistics and diagnostics.

Offering even higher capacity, Teltone’s M-861 handles as many as 32 full-duplex, 9,600-bps asynchronous channels or eight 9,600-bps synchronous data streams at composite-link speeds to 76.8K bps. Two to 18 composite links can be supported.

SIX MANUFACTURERS CONTROL NEARLY HALF OF THE 1984 U.S. MULTIPLEXER MARKET

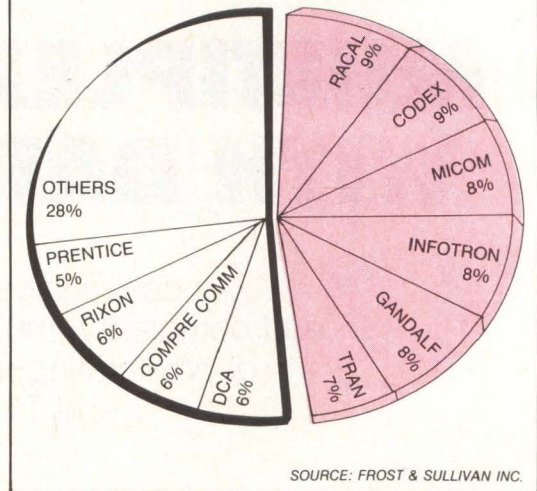

For widely dispersed terminals, multidrop STDMS, such as the 670 Series from Codex Corp., permit dumb asynchronous terminals to share one four-wire, 4,800-bps leased line to the host-computer site. With the master unit at the host computer and slave units in as many as eight remote sites, the master polls the slaves for activity, allowing as many 16 terminals to operate as if each had a dedicated line to the host.

STDMS take over

Indeed, most analysts see intelligent statistical multiplexers, such as the Codex, Gandalf or Teltone units as supplanting time-division multiplexers (TDMs), and particularly data concentrators, in most datacomm applications. STDMS constitute one of the fastest growing areas of the multiplexer market, asserts Bosomworth: “STDMS are taking over. Stat muxes are going way beyond statistical techniques. They are using other techniques such as data compression to get more effective utilization of the data line. TDMs are a fading market.” Another market researcher, Frost & Sullivan Inc., New York, forecasts a “dramatic switch” by users from the older time-division multiplexers to “more advanced” statistical multiplexers.

Other analysts, however, don’t see such a quick demise for TDMs. These units sequentially gather data from connected terminals, assign each a fixed number of time slots, then transmit the data sequentially in blocks over the high-speed line for separation by the receiving multiplexer. TDMs are generally most efficient when

all terminals transmit at or near their maximum rate; bandwidth is wasted when fill bits are transmitted in place of data. The generally more expensive STDMs, in contrast, assign bandwidth (and time slots) dynamically according to the amount of terminal activity, not according to a fixed pattern, thus maximizing bandwidth utilization.

"STDMS generally offer more effective utilization of the line," explains Datapro's Jordan, "but there are applications where the TDM is still most effective. In an IBM Corp. 3270 SNA environment, for example, you are better off with a TDM because SNA does what a stat mux does and fills the line. It's not cost-effective to use a stat mux in this environment." System integrators and end users should select the most cost effective, not necessarily the most technologically advanced, device for their application, Jordan emphasizes. "Saving money is the bottom line in the multiplexer market."

"STDMS do not work very well at high speeds," says Kevin O'Connor, account manager for multiplexers at Timplex Inc., Woodcliff Lake, N.J. "There is no delay with TDMs on a wideband pipe." O'Connor is skeptical of exaggerated claims for STDMS, which he says are sometimes propagated by multiplexer vendors who don't offer a broad line of devices. "The TDM market is still very strong," he claims, "and it's going to increase, [even] if not to the level to which the STDMS market is going to grow."

Predicting strong market growth

Despite disagreement on technology, most analysts concur that the overall multiplexer market will enjoy solid growth. Bosomworth predicts 15- to 20-percent "steady" annual growth through the end of the decade. Racal-Milgo's Schlafly sees the market as growing 35 percent to 40 percent "depending on the market segment." Frost & Sullivan is equally optimistic, forecasting greater than 35-percent annual growth in dollar value of shipments through 1988, with the fastest market growth toward the end of the period. Over the same period, unit shipments will increase annually at a greater-than-31-percent rate, the company says.

Data compression, combined with statistical multiplexing, is another technique multiplexer manufacturers are using to boost their products' effective data throughput. "If you can't go to a higher-cost line," stresses Datapro's Jordan, "data compression is one way to squeeze more information onto the line." Chung Communica-

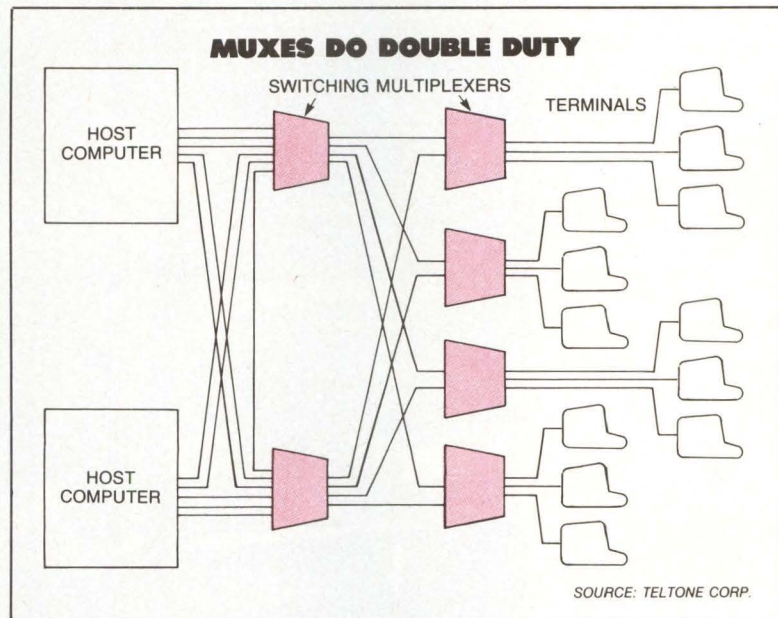

tions' Turbo-MUX-2, for example, employs a proprietary compression technique to support two 2,400-bps, full-duplex channels over one 212A data link. Providing automatic error detection and correction, it supports built-in diagnostics and switchable X-on/X-off flow control.

Compressing text, graphics, facsimile and other data at a 2:1 ratio, the Datamizer from Simplex Communications Corp. doubles the net throughput of a 9.6K-bps line to 19.2K bps, allowing four asynchronous or synchronous devices to share the line. The statistical multiplexer supports both bit-oriented (X.25, SDLC, HDLC) or byte-oriented (binary synchronous 2780, 3780, 3270) protocols.

As traffic densities increase and datacomm networks expand across national boundaries, multiplexers are expanding their capabilities to interface with satellite links, X.25 packet-switching systems and digital T.1 lines, as well as the standard dedicated, private or direct dial system (DDS) lines.

Satellite hookups, however, can present special problems for multiplexers, especially for STDMS using the common GO-BACK-N ARQ error-protection scheme. The transmitting multiplexer stores N frames of data, typically seven, for retransmission should an error occur. However, in satellite links, the round-trip delay frequently exceeds the time it takes to send and acknowledge the seven frames. Multiplexers must therefore be able to handle a sufficient number of unacknowledged frames before considering the transmission to be in error. Codex's

Switching multiplexers can serve as front-end switches to multiple host computers as well as control access to ports in a redundant network.

Equinox didn't invent the Data PBX...



we just perfected it!

All the Data PBX features you need

Port selection: User-controlled terminal switching between computers.

Access control to keep your database secure from unauthorized personnel and to protect dial-in lines from "hackers".

Port contention or sharing for maximum port utilization and economy.

Network control from a central point; alter system configuration, collect statistics and perform diagnostics.

Non-blocking architecture permits 660 full-duplex connections at 9600 bps.

Plus these Equinox only features

Expandable from 24 to 1320 lines without taking your system down.

User-friendly menu-driven battery-backed configuration plus on-line help.

Compact dimensions: 360 lines in the unit shown above. Less than one sixth the size of Micom or Gandalf PBXs!

Simple do-it-yourself installation using low-cost modular telephone wiring.

Complete system backup with auto-switchover power and logic, plus comprehensive on-line diagnostics.

And the price: under \$100 per line. No other LAN compares!

Call 1-800-DATA-PBX* for a free color brochure and on-site demonstration.

EQUINOX

Systems

12041 SW 144th Street, Miami, Florida 33186 * In Florida call (305) 255-3500 · Telex 289307

6001 Intelligent Network Processor, for example, offers variable-length ARQ, where N can be as large as 127. It supports as many as eight asynchronous devices at speeds to 9,600 bps and a synchronous trunk rate to 14.4K bps. Optional integral modems operate at 4,800 or 9,600 bps.

X.25 market expands

Links to X.25 packet-switched communications networks are offered by an increasing number of vendors. "X.25 nets are a growing market area," comments The Yankee Group's Amster. "According to our data, 70 percent of all people with DECnets [from Digital Equipment Corp.] intend to have X.25 capability by early this year."

Typical of these multiplexers is Digital Communications Associates Inc.'s INA Terminal Interface Processor. Connecting as many as 32 asynchronous devices and operating to 9.6K bps with a public data network, it supports the three levels of the X.25 protocol. Its X.3 PAD facility interfaces to the network according to Comité Consultatif Internationale Téléphone et Télégraphique (CCITT) X.29 standards. Interfacing to character-mode terminals and hosts follows X.28 recommendations. It also provides automatic baud-rate detection, local Echoplex, firmware-based diagnostics and network-management functions.

The X.25 Link Module for the Infotron Systems Corp.'s 990NP/992NP Network Processor handles as many as 255 channels over a link running at speeds to 72K bps. Either NRZ or NRZ1 bit-transmission format can be selected. Other X.25-compatible multiplexers include Micom Systems Inc.'s M 800/X.25 PAD, Databit Corp.'s ANP 2520 Advanced Network Processor and General Datacomm Industries Inc.'s 1261.

Satellite links and X.25 interfaces notwithstanding, most of the excitement in the multiplexer arena is focused on links to AT&T Communications' T1 1.544M-bps leased digital line. "T1 multiplexers are a hot market item," emphasizes Datapro's Jordan. "For a very large firm, they can multiplex a large number of terminals cost-effectively."

T1 lines slash datacomm costs

"The hottest development in the marketplace today is that all big users are looking at T1 transmission to lower their costs," agrees Timeplex's O'Connor. "T1 gives users the ability to crank both voice and data over the wideband network, eliminating the cost of multiple 9,600- or 56,000-bps lines."

"Companies are replacing a multitude of private lines with one T1 circuit," says P. Christensen, president of T1 multiplexer vendor, Aydin Monitor Systems Division, Fort Washington, Pa. "They are less concerned about the cost of the equipment and more worried about the monthly line charges, which can be rather astronomical. Any money you save on the telephone bill goes right to the bottom line. The incentive is there, the payback is very short, and the cost savings can be dramatic. One large company's [Rockwell International] reduced telephone bill alone will pay for the equipment in only six months."

Christensen points to users' needs for higher capacity and flexibility as driving forces in the T1 multiplexer market. "The T1 leased line rate was set to be slightly less than the equivalent cost of 24 private circuits," he notes. "Obviously, if you can put more than 24 channels on the line, you

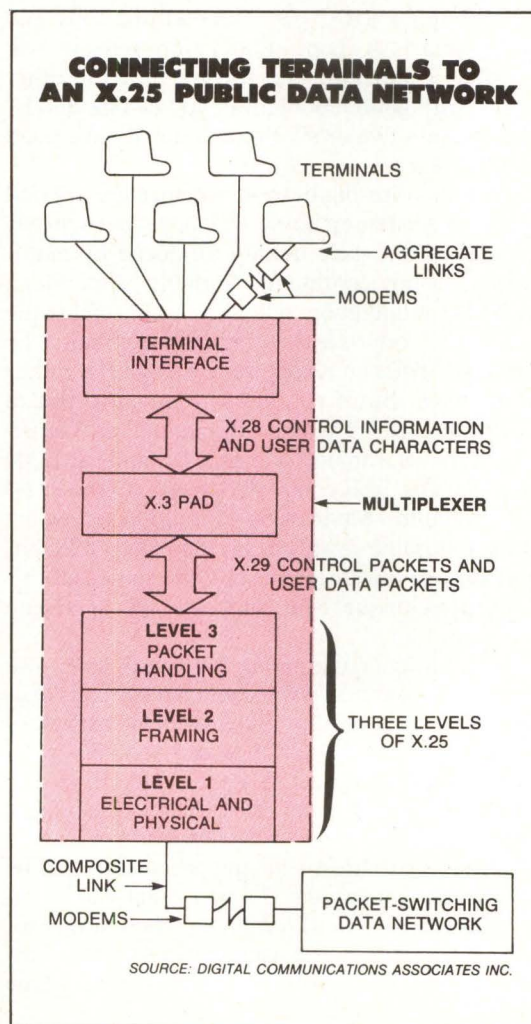

Multiplexers connecting terminals to a public packet-switching network must accommodate three levels of the X.25 standard and perform packet assembly/disassembly (PAD) functions. CCITT recommendations X.28 and X.29 govern interfacing respectively between the PAD unit and the terminals and the X.25 packet-forming facilities.

**'Stat muxes
are going way
beyond
statistical
techniques'**

get a large savings." In addition, large firms want the flexibility to be able to run several types of services over wideband lines, Christensen says, including facsimile transmissions via modem ("very important to large corporations"), efficient hook-ups for computer data circuits, live-action TV conferencing ("without paying the price the phone company charges") and toll-line-quality voice communications.

Good voice quality is crucial

Christensen particularly stresses the importance of quality digitized-voice transmission. "It's crucial not to degrade voice quality as you add services," he says. "In a large corporation, the senior people get rather sensitive when they can't recognize the voice at the other end." The voice quality of acoustic-modem data transfer, for example, is extremely difficult to control. And the complexity of today's large networks can cause further problems when users have to go through a PBX, get a second dial tone and dial again. "A poor modulation scheme will produce distortion," he warns. "On the other hand, with good modulation, you can modulate/demodulate five or six times and still have good voice quality."

Not all voice digitization schemes are created equal, Christensen says, and he is particularly critical of the voice quality produced by multiplexers using continuous variable slope delta (CVSD) modulation schemes. "The technique does not produce a toll-grade voice circuit," he asserts. "You can recognize a man with a rather deep voice. But if you put a woman on, you've got problems." This type of equipment, Christensen claims, can only transmit facsimile at 1,200 or 1,400 bps. This contrasts, he says, to the 9,600 bps of Aydin's Model 6296 T1 multiplexer, which uses a variable quantum level (VQL), 32K-bit, pulse-code-modulation (PCM), voice-digitization technique and supports 48 aggregate channels.

Racal-Milgo's Omnimux T-1 multiplexer also consolidates multiple voice and data circuits over one high-speed facility. Supporting 48 asynchronous channels to 19.2K bps and as many as 96 synchronous channels to 460.8K bps, it accommodates voice-channel rates to 64 kHz and furnishes centralized network-management and diagnostic capabilities. Channel parameters can be down-line loaded, and the unit is software-configurable from ASCII terminals. The multiplexer also supports synchronous composite transmission at the 2.048M-bps rate available for T1-type services in European networks.

Another TDM product, Timeplex's LINK/1 Facilities Management System, also offers a composite link to 2.048M bps as well as traffic-balancing capability, automatic alternate routing, dynamic bandwidth contention with programmable port priorities and single-point network control. It handles as many as 200 data ports with data rates to 576K bps.

TDMs, such as the Omnimux or LINK/1, are superior to statistical TDMs in T1 applications combining voice and data on the digital line, asserts The Yankee Group's Amster. "STDMs are not very good for voice communications," he says, because the STDM is a store-and-forward device that accepts data and puts it on the line in the next available time slot. But the slot might be delayed, and average delays with a heavy traffic load can run to 150 or 250 msec.

"You start getting unacceptable degradation of voice communications with 150-msec delays," Amster says. "Furthermore, if you want to transmit video using an STDM for T1, you'll have the same kind of problem. You can't have these random delays." For this reason, in the T1 range at least, "the TDM is coming back in," he maintains.

T1 delay decreasing

Clouding the T1 picture for system integrators and end users is the delay in getting T1 lines, which has been pegged at 24 to 28 months by some analysts. This assessment, however, is considered overly pessimistic by sources at AT&T Communications, who say that the situation is finally coming back to normal after the impact of deregulation.

"The normal interval we quote customers is a nine-to-12-month delay for installing a T1 line," stresses Jim Shannon, staff manager of new services development, AT&T Communications, Bedminster, N.J., "and we have been meeting that. As the phone network becomes more digital, and we get all our fiber-optic links in place, the digital service interval should shrink." Service managers would like to see the wait reduced to six months, Shannon adds, but he doesn't anticipate that happening for a few years.

Definitely in the cards for T1 service, though, is a future American National Standards Institute (ANSI) standard and eventual compliance with international CCITT recommendations. "AT&T is represented on the ANSI T1 Committee," says Shannon. "We've taken the position that whatever standards come out of that committee, we will adopt as the interim North American standard until our network has clear-chan-

The first 128-line multiplexor to give you 128 lines.

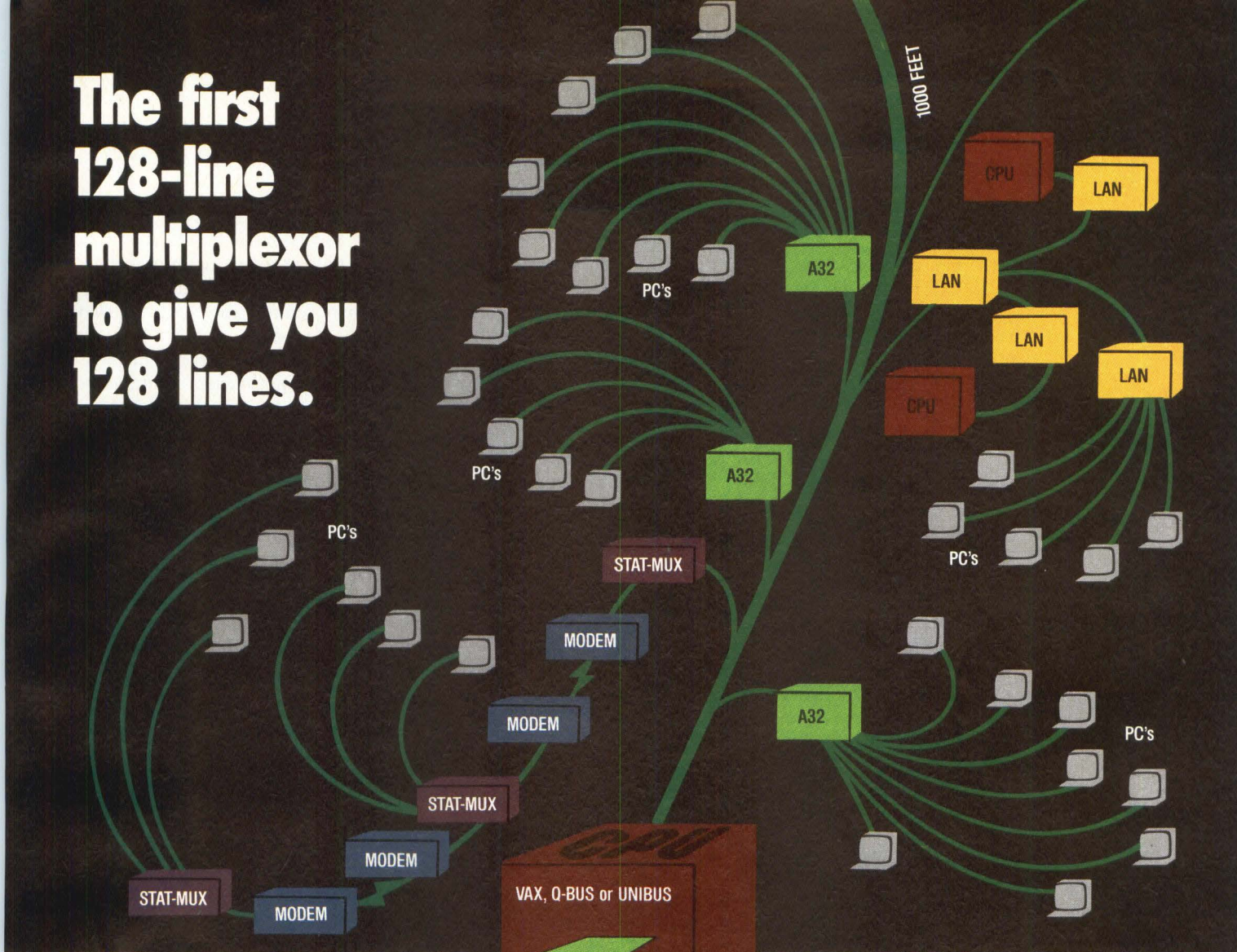

Now up to 128 asynchronous serial communication devices, from as far away as 1,000 feet, can communicate with DEC's* VAX, Q-bus and Unibus* computers.

MDB's new DMF Series Multiplexor was developed because we know systems designers need more efficient ways to control statistical multiplexors, LAN's, dynamic asynchronous terminal line switches and interprocessor links, in the new data communications world.

So from configuration to operation and installation, we've thought of everything to make it possible. Featuring a space-saving quad sized format, our DMF series is comprised of a host processor board, one or more asynchronous channel boards (A32), and a selection of connector panels.

It means true 128 line capability because terminals can be placed in up to 16 separate clusters anywhere along the 1,000 foot bus and each channel board can control up to a maximum of 32 RS32 terminals running up to 19.2 K baud (38.4 K baud optional).

*DEC, VAX, Q-bus, Unibus, RSTS/E and RSX11-M+ are trademarks of Digital Equipment Corporation.

MDB
SYSTEMS INC.

Corporate Headquarters
1995 N. Batavia Street, Box 5508
Orange, CA 92667-0508
Tel. 714-998-6900 TWX: 910-593-1339
FAX: 714-637-4060

MDB Systems U.K., Ltd.
Basingstoke, Tel. 44 0256 464767
TELEX: 858389 MDBSYS G

The host board uses the 29116 ultra-high performance 16-bit, 100 nanosecond microprocessor, 104 bit wide micro-word, and special logic structures, for the fastest DMF emulation available.

User versatility counts too. The DMF Multiplexor offers such unequalled through-put advantages as the capability to select silo or DMA transfers automatically; and with 16, 18 or 22 bit addressing, the designer can choose the best configuration for the DEC system used. Also, it has its own optimized software drivers for those who have DEC's RSTS/E and RSX11-M+* operating systems.

Now that you can finally use all 128 lines, you may find that you like the bottom line best. All of those technological advances make it the lowest per line cost possible.

Extending the capability of DEC systems is what we're all about. That's why you should contact us immediately with your questions on our new DMF Series Multiplexor or our complete line of DEC compatible system enhancers.

In the western states MDB products are also distributed by **WYLE** LABORATORIES ELECTRONICS MARKETING GROUP

CIRCLE NO. 20 ON INQUIRY CARD

nel capability, at which time we will adopt CCITT standards." Clear-channel capability, Shannon says, permits 64K-bps traffic to be transmitted as 64K bps and not as 56K bps to allow for control bits and other overhead.

Further down the road for T1 multiplexer vendors is the challenge of the proposed worldwide integrated services digital network (ISDN). CCITT objectives for ISDN include the integration of voice, data, Telex, X.25 and X.21 interfaces, videotex, electronic mail and electronic funds transfer.

A look at tomorrow's products

Whatever the future impact of the ISDN on product specifications, multiplexers will continue to offer a wider range of functions, analysts say. Racal-Milgo's Schlafly, for example, sees further progress in network control and diagnostics as well as an extension of the access-control features of high-end products. "Access control is becoming available on modems," she observes. "Perhaps we will see secure multiplexers with encryption features on the aggregate links."

"You are going to see the box containing more and more," predicts Amster. "It's going to start containing protocol conversion and gateway software as well as a modem. And it's probably going to have hooks back into network management capability." As multiplexers continue to integrate functions, Amster says, high-end units will be increasingly pressured by digital private branch exchanges (PBXes), which will encroach on multiplexer functions. "PBXes are starting to absorb multiplexers and modems and use them in a shared environment."

Microprocessors and very large-scale integration (VLSI) technology will continue to have a significant impact on multiplexer development, Amster says. "We are seeing chip sets for things that used to take boxes," he observes. "Multiplexers are getting smaller and easier to make. [Tomorrow's units] will do more features for less." □

Interest Quotient (Circle One)
High 453 Medium 454 Low 455

The Panaflo

BY

Panasonic

Competitively Priced to Meet Your Design Requirements

- Size: 40, 60, 80, 92, 120mm²
- Voltage: 12V - 24V
- Air Flow: 5CFM to 108CFM

A low cost axial flow fan that brings with it the buying confidence the name Panasonic has to offer and the product that can meet with your design needs.

Features include:

- Brushless DC Motor
- Ball Bearing Fan
- Low RF and Audible Sound
- High Efficiency
- Adjustable Speed
- Prompt Delivery

To obtain literature, call or write:

Panasonic Industrial Company,
Division of Matsushita
Electric Corporation of
America, Industrial Motor
Department, 425 East
Algonquin Road, Arlington
Heights, Illinois 60005
Phone: 1-312-981-4823



DC Brushless Axial Flow Fan

Panasonic Industrial Company

CIRCLE NO. 21 ON INQUIRY CARD

**Wondering
Where
To Turn
Next?**

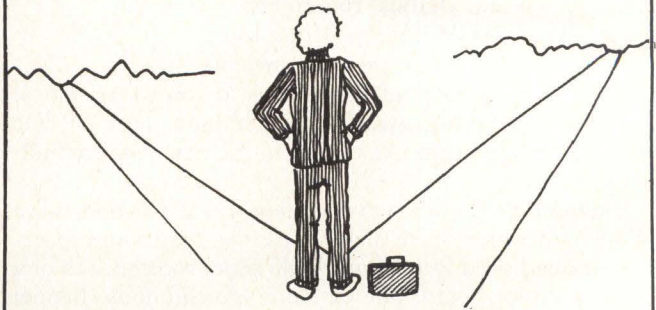

**Turn To
Mini-MicroSystems**

**Career
Opportunities
Section**

CIRCLE NO. 22 ON INQUIRY CARD

Looking for a Smart Data Manager for Your Office?

Introducing SWITCHMUX, the Perfect Candidate.

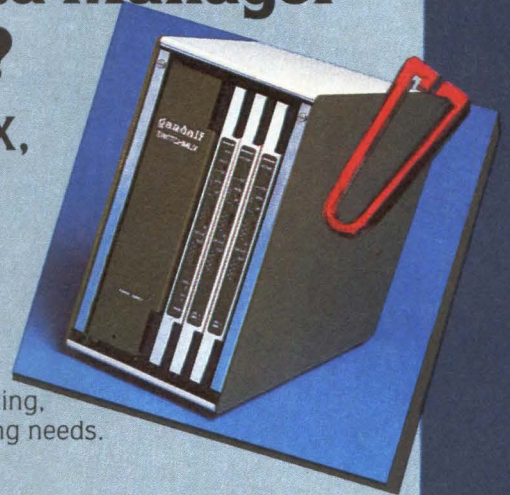

Resume

GANDALF SWITCHMUX

Current Address:

Willing to Re-locate

Career Objective:

To handle your statistical multiplexing, local switching and data networking needs.

Qualifications:

Data handling

Up to 16 subscribers
Async and sync
Up to 19.2Kbps async
Up to 4.8Kbps sync
153.6Kbps aggregate input

Composite link(s)

One or two (selectable) synchronous (HDLC) link(s)
64Kbps aggregate link data rate
16 bit CRC error detection, ARQ
Automatic switchover capability

Work Experience:

Local Switching



Up to 16 subscribers

Statistical Multiplexing



Up to 32 subscribers

Data Networking

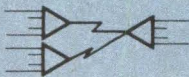

Up to 48 subscribers

Facilitated networking between PCs micros, printers and wordprocessors in the sales department.

Provided significant line savings and error correction between the main office and the remote office.

Interconnected three offices enabling them to pass data and networked these offices to a PACXNET corporate information system.

Network Management

Provided local or remote console control with multi-level security, critical link redundancy, loadsharing with automatic switchover, complete diagnostics and statistical usage data.

Salary requirements:

One time fee. No coffee breaks, overtime or vacation pay.

Availability:

December 1984

Health:

Excellent reliability. One Year Warranty. No sick leave.

References:

Available upon request from Gandalf representatives worldwide.

gandalf[®]

USA: (312) 541-6060
Canada: (613) 226-6500
UK: (0925) 818484
Europe: 22-98-96-35
Telex 22349

DILOG PROCLA FOR DEC CO

Introducing OPTIMUX™ communications controllers. Four new ways for DEC™ users to free up their VAX™, PDP-11™ and LSI-11™ systems. No other controllers even come close to offering the high-performance features you get with OPTIMUX.

FREEDOM FOR UNIBUS USERS.

DILOG's 16-channel OPTIMUX/16DMF+ works with all VAX and PDP-11 computers. It's the first one-board controller with all DEC DMF and DH11 functions.

For high-throughput applications, the 16DMF+ offers three important enhancements:

Bidirectional flow control virtually eliminates the potential for data loss.

Multi-word DMA transfers reduce CPU overhead during all communications operations.

The 16DMF+ also offers software-selectable data transfer rates—from 50 bps to 38,400 bps.

You can add PCs, graphics terminals, high-speed digitizers, stat-muxes, or simply more I/O stations. OPTIMUX keeps response time down and efficiency up.

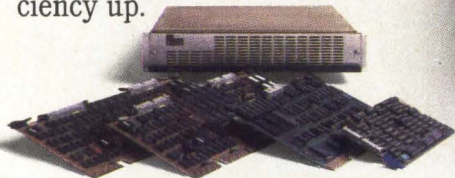

Should you need even greater capacity, there's the add-on 32-channel OPTIMUX/32DMF+. It contains two 16DMF+ boards,



AIMS FREEDOM COMPUTERS.

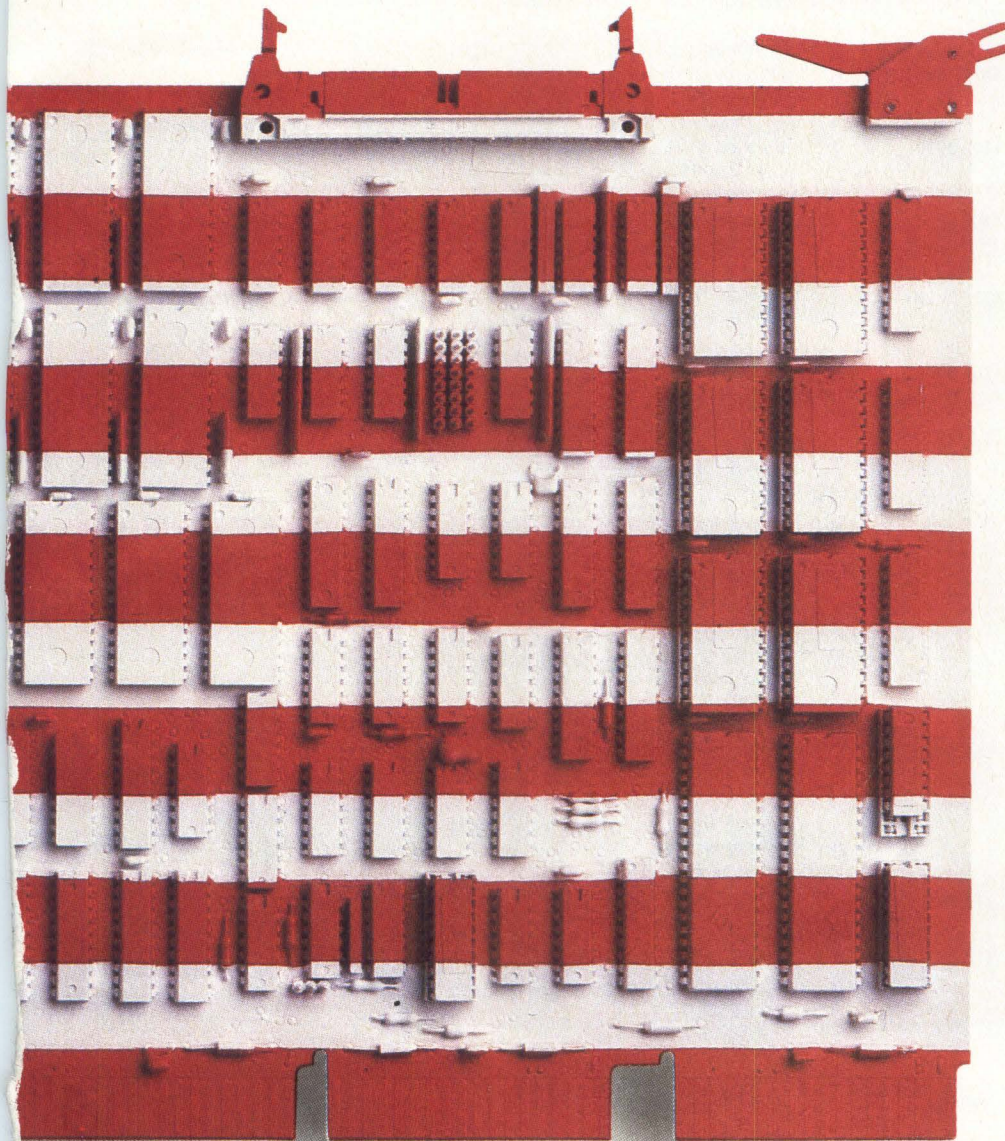

and adds four slots and 20 amps to your host computer. You can daisy-chain two, three, four or more of these units to over 128 channels without using any host power or backplane space!

FREEDOM FOR QBUS™ USERS.

For LSI-11 systems, the OPTIMUX/64DH exceeds all the capabilities of DEC's DH11.

Occupying just one backplane slot on the QBUS, this single, quad-height board expands up to 64 asynchronous communications channels in 16-channel increments.

To prevent loss of received data during high traffic conditions, the 64DH features a switch-selectable 64 or 128-character FIFO buffer.

The 64DH is compatible with the standard DH11 and DM11 drivers contained in the RSX-11™, RSTS/E® and UNIX® operating systems.

Still another new product for QBUS is the OPTIMUX/8DZ. It multiplexes eight RS232 data channels on a single, dual-height board and is software compatible to the DZ11 driver.

Isn't it time you proclaimed freedom for your DEC computer systems? For more information on OPTIMUX controllers, call (714) 937-5700. Or write DILOG, P.O. Box 6270, Anaheim, CA 92806.

DILOG

EMULATION IS NOT ENOUGH.

CIRCLE NO. 24 ON INQUIRY CARD

MULTIPLEXERS

TABLE 2

Company Model	Input channels		Output channels		Composite link protocols	Buffer size (K bytes)	Automatic bit rate detection?	Technique	Price (\$)	Notes, features, options
	Max. asynch (speed-bps)	Max. synch (speed-bps)	Max. asynch (speed-bps)	Max. synch (speed-bps)						
AVANTI COMMUNICATIONS										
TPAC1.5		4 (up to 1.344M)		1 (up to 1.544M)	transparent		no	TDM		
ULTRA MUX	128	64 (up to 1.344M)		4 (up to 10M)	transparent		yes	TDM		
BAY TECHNICAL ASSOCIATES										
524E	4 (300-19.2K)		1 (300-19.2K)		CCITT V.24, X-on/X-off, DCE, DTE ports	2	no	STDM	319-359	rackmount; opt. 220V
528E	8 (110-9600)		1 (110-9600)		CCITT V.24, X-on/X-off DCE, DTE ports	4	no	STDM	609-694	rackmount; opt. 220V
5218E	17 (110-9600)		1 (110-9600)		CCITT V.24, X-on/X-off, DCE, DTE ports	8	no	STDM	1,750	rackmount; opt. 220V
524ES	4 (300-19.2K)		1 (300-19.2K)		CCITT V.24, X-on/X-off DCE, DTE ports	2	no	STDM	319-359	rackmount, 220V
528ES	8 (110-9600)		1 (110-9600)		CCITT V.24, X-on/X-off DCE, DTE ports	4	no	STDM	609-694	rackmount, 220V
5218ES	17 (110-9600)		1 (110-9600)		CCITT V.24, X-on/X-off DCE, DTE ports	8	no	STDM	1,750	rackmount, 220V
CASE RIXON COMMUNICATIONS INC.										
840	4-240 (9600)			15 (72K)	CCITT V.35, HDLC, RS232C, RS422, X.25	16-256	yes	STDM		
850	4-240 (9600)			14 (72K)	CCITT V.35, HDLC, RS232C, RS422, X.25	16-256	yes	STDM		
DCX 725		4 (9600)	1 (19.2K)		CCITT V.24, V.28; RS232C		no	bit-interleaved TDM		
DCX 812	8 (9600)			1 (19.2K)	CCITT V.24, RS232C	15	yes	STDM		
DCX 817	2-6 (up to 9600)		1 (19.2K)			8	yes	STDM		
DCX 825	4-32 (9600)	4 (9600)	1 (19.2K)	1 (19.2K)	CCITT V.24, HDLC, X.25	16	yes	STDM		
DCX 836	4-60 (9600)			1 (72K)	CCITT V.35, HDLC, RS232C, RS422, X.25	16-256	yes	STDM		
COMMUX	4-8 (9600)		1 (9600)		HDLC, X.25	5.5	yes			
CHUNG TELECOMMUNICATIONS INC.										
Turbomux-2	2 (1200, 2400)			1 (1200)	X-on/X-off	16	no	STDM	995	ARQ error protection, local and remote loopback
CODEX CORP.										
604 TDM		4 (19.2K)		1 (19.2K)			no	TDM	1,650-2,200	loopback diagnostics
670 STD	16 (110-4800)		1 (2400)	1 (9600)	X.25 level 2	1.5-14	no	STDM	1,350-5,300	multidrop, individual channel loopback

**MULTIPLEXERS
TABLE 2**

Company Model	Input channels			Output channels		Composite link protocols	Buffer size (K bytes)	Automatic bit rate detection?	Technique	Price (\$)	Notes, features, options
	Max. asynch (speed-bps)	Max. synch (speed-bps)	Max. asynch (speed-bps)	Max. synch (speed-bps)							
6001 INP	8 (50-9600)			1 (14.4K)	X.25 level 2	16	yes	STDM	1,500-4,975		
6002 INP	16 (50-19.2K)			1 (19.2K)	X.25 level 2	32	yes	STDM	1,900-7,675	6000 series compatible	
6005 INP	16 (50-19.2K)	16 (50-19.2K)		1 (19.2K)	X.25 level 2, HDLC, SDLC, bisynch	32	yes	STDM	3,300-9,925	local and remote loopback, terminal initiated diagnostics	
6035 INP	124 (75-4800)	124 (1200-9600)		3 (19.2K)	X.25 level 2, Codex, HDLC, SDLC, bisynch	16-32	yes	STDM	4,500-25,000	6000 series networking capability, local and remote loopback	
6050 DCP	120 (50-19.2K)	120 (50-19.2K)		8 (64K)	X.25 level 2	16-200	yes	STDM	25,000-100,000	adaptive routing, centralized network control, ARQ error protection	
COHERENT COMMUNICATIONS SYSTEMS CORP.											
DSM-32		3 (9600)		1 (up to 64K)	CCITT X.21, G.703		no	TDM	2,000		
DSMT-7		6 (19.2K)		1 (64K)	CCITT X.21, G.703		no	TDM	1,500-2,500		
TDM-95	12 (19.2K)			1 (1.5M)	RS232C		no	TDM	295		
COMDESIGN INC.											
TC-500A	32 (50-9600)	28 (1200-9600)	1 (1200-19.2K)	1 (1200-19.2K)	X.25 level 2, SDLC, HDLC, ADCCP ANSI X.3.66	64-320	yes	STDM	1,800-8,000	diagnostics, error correction; opt. rackmount	
TS-600	32 (50-9600)	28 (1200-9600)	1 (1200-19.2K)	1 (1200-9600)	X.25 level 2, SDLC, HDLC, ADCCP ANSI X.3.66	64-320	yes	STDM	8,500	diagnostics, error correction; opt. rackmount	
TX-700	32 (up to 9600)		1 (up to 19.2K)	1 (19.2K)	CCITT V.24, X.25, LAPB	128-320	yes	STDM	1,950-8,150	diagnostics, error correction, non-volatile store	
COMPLEX SYSTEMS INC.											
TX3	3 (9600)			1 (9600)	proprietary packet switching	16	no	STDM	795	diagnostics, speed conversion	
TriMux	3 (9600)			1 (9600)	proprietary packet switching	16	no	STDM	995	diagnostics, speed conversion	
TriMux.M	3 (9600)		1 (2400)	1 (9600)	proprietary packet switching	16	no	STDM	1,625	speed conversion	
TriMux.212	3 (9600)		1 (1200)	1 (9600)	proprietary packet switching	16	no	STDM	1,495	speed conversion	
CONCORD DATA SYSTEMS INC.											
224 SUPERDUPLEX	3 (9600)		1 (2400)		SDLC		yes	STDM	1,575-1,695	diagnostics, error correction	
DATABIT INC.											
ANP 2520	128 (19.2K)	128 (19.2K)		6 (56K)	X.75 proprietary	512	yes	STDM			
DATA COMMUNICATIONS BROKERS INC.											
LINK 2	2 (9600)		1 (9600)	1 (9600)	proprietary	6	no	STDM	795		
LINK 4	4 (9600)		1 (9600)	1 (9600)	proprietary	12	no	STDM	1,195		
DATAGRAM CORP.											
DM900	9 (75-9600)	1 (1200-9600)	1 (9600)	1 (19.2K)	X.25 level 2, X-on/X-off	16-64	yes	STDM	1,250-2,150	ARQ error protection, local and remote, terminal and channel loopback, self-test	
DM1600	16 (75-9600)	2 (1200-9600)	1 (9600)	1 (19.2K)	X.25 level 2, X-on/X-off	16-64	yes	STDM	1,800-4,200	ARQ error protection, local and remote, terminal and channel loopback, self-test	

MULTIPLEXERS
TABLE 2

**MULTIPLEXERS
TABLE 2**

Company Model	Input channels			Output channels		Composite link protocols	Buffer size (K bytes)	Automatic bit rate detection?	Technique	Price (\$)	Notes, features, options
	Max. asynch (speed-bps)	Max. synch (speed-bps)	Max. asynch (speed-bps)	Max. synch (speed-bps)							
DM4800	52 (75-9600)	4 (1200-9600)	1 (9600)	1 (19.2K)	X.25 level 2, X-on/X-off	16-64	yes	STDM	3,650-13,250	ARQ error protection, local and remote, terminal and channel loopback, self-test	
DATATEL INC.											
DCP5000	4 (9600)			1 (19.2K)	SDLC	16	yes	STDM	1,300	channels configured independently	
DCP5020	2 (9600)			1 (19.2K)	SDLC	16	yes	STDM	1,100	channels configured independently	
DEVELCON ELECTRONICS INC.											
DS-1600	4-16 (up to 9600)		1 (up to 19.2K)	1 (up to 19.2K)	X.25 level 2	16-64	yes	STDM	2,600-5,000	diagnostics, statistics, error checking	
DS-1800	3-9 (up to 9600)		1 (up to 19.2K)	1 (up to 19.2K)	X.25 level 2	16-64	yes	STDM	1,550-2,750	diagnostics, statistics, error checking	
DS-4800	4-52 (up to 9600)		1 (up to 19.2K)	1 (up to 19.2K)	X.25 level 2	16-64	yes	STDM	3,650-13,250	diagnostics, statistics, error checking	
DIGITAL COMMUNICATIONS ASSOCIATES INC. (DCA)											
System 110	8 (50-9600)			1 (19.2K)	transparent, DDCMP	20	yes	STDM	1,495 (4 port)	buffer allocation, error checking; opt. network management	
System 120	32 (50-9600)			1 (19.2K)	transparent, DDCMP	20	yes	STDM	2,450 (4 port)	buffer allocation, error checking, network management	
System 125	32 (50-9600)			1 (19.2K)	transparent, DDCMP	26	yes	STDM	3,250 (16 port)	ARQ error correction, dynamic buffer allocation, diagnostics, error checking	
System 205	128 (110-9600)			1 (9600)	transparent, DDCMP	6	yes	STDM	4,250	derives power from DEC Unibus, replaces up to 16 DEC DZ11, diagnostics, error checking, network management, board level	
System 207	128 (110-9600)			2 (38.4K)	transparent, DDCMP	32	yes	STDM	4,950	board level, replaces up to 16 DEC DMF 32, diagnostics, error checking, network management	
System 325 (NetSwitch)	1120			8 (19.2K)	transparent, DDCMP	736	yes	STDM	11,595 (32 port)	host selection, diagnostics, error checking, network management	
System 335	42 (110-9600)			4 (4800-56K)	X.25, DDCMP	736	yes	STDM	6,795	diagnostics, error checking, host selection, network management	
System 355	126 (110-9600)			44 (4800-56K)	X.25, DDMCP	736	yes	STDM	9,995	diagnostics, error checking, host selection, network management	
System 375	126 (110-9600)			22 (4800-56K)	X.25, DDCMP	736	yes	STDM	16,995	diagnostics, error checking, host selection, network management	
INA/X.25 PAD	32 (9600)			1 (19.2K)	X.25, X.3 PAD support	25	yes	STDM	2,495 (4 port)	ARQ error control, network management	
DOELZ NETWORKS INC.											
ELITE ONE	16 (9600)	16 (9600)		6 (72K)	transparent	128	yes				
ESPRIT ONE	1072 (19.2K)	1072 (19.2K)		67 (72K)	transparent	128-1M	yes				
EMULEX CORP.											
C521/F	16 (50-19.2K)			1	DEC Unibus		no	TDM	2,950	compatible with DEC DMF32	
CS01/H	64 (50-19.2K)			1	DEC Q-bus		no	TDM	3,000-13,000	compatible with DEC DH11	
CS02/H	16 (50-38.4K)			1	DEC Q-bus		no	TDM	2,300	compatible with DEC DH11, DHV11	

**MULTIPLEXERS
TABLE 2**

Company Model	Input channels		Output channels		Composite protocols	Buffer size (K bytes)	Automatic bit rate detection?	Technique	Price (\$)	Notes, features, options
	Max. asynch (speed-bps)	Max. synch (speed-bps)	Max. asynch (speed-bps)	Max. synch (speed-bps)						
CS11/F	48 (50-19.2K)			1	DEC Unibus		no	TDM	4,500-10,500	compatible with DEC DMF32
CS11/H	64 (50-19.2K)			1	DEC Unibus		no	TDM	3,500-13,500	compatible with DEC DH11
CS11/U	64 (50-19.2K)			1	DEC Unibus		no	TDM	3,950-13,950	compatible with DEC DH11
CS11/V	32 (50-19.2K)	32 (1200-9600)		1	DEC Unibus		no	TDM	4,950-9,700	
CS21/H	16 (50-19.2K)			1	DEC Unibus		no	TDM	2,950	compatible with DEC DH11
CS21/U	16 (50-19.2K)			1	DEC Unibus		no	TDM	3,450	includes DEC VAX/VMS driver, compatible with DEC DH11
CS21/2	16 (50-19.2K)			1	DEC Unibus		no	TDM	2,950	compatible with DEC DZ11
CS32/F	128 (50-38.4K)			1	DEC Unibus		no	TDM	5,000-27,400	compatible with DEC DMF32
STATCON SERIES 11	64 (50-9600)			1 (up to 19.2K)	proprietary	15	yes	STDM	7,300	compatible with DEC DH11
STATCON SERIES 21	32 (50-9600)			1 (up to 19.2K)	proprietary	15	yes	STDM	6,300	compatible with DEC DH11, DZ11
STATCON SERIES 32	256 (50-9600)			1 (up to 19.2K)	proprietary	15	yes	STDM	8,100	compatible with DEC DMF32
GANDALF DATA INC.										
Line Miser GLM 504		4 (56K)		1 (56K)	transparent		yes	bit-interleaved synch TDM	1,550	local loopback, remote test modes
Line Miser GLM 510	8 (9600)			1 (270)	transparent		yes	TDM	425-600	opt. rackmount
PIN 9103	32 (9600)			1 (19.2K)	HDLC, X.25 level 1-2, HP ENQ/ACK	4-12	yes	STDM	1,650-2,750	statistics, diagnostics; opt. rackmount
PIN 9106	4 (9600)		1 (9600)	1 (9600)	SDLC	3	yes	STDM	825-1,085	error correction, diagnostics
PIN 9101E	16 (9600)			1 (19.2K)	HDLC, CCITT X.28, X.29, LAPB, X.25 level 1-2-3	4-12	yes	STDM	2,650-5,150	diagnostics; opt. rackmount
SWITCHMUX	16 (19.2K)	4 (4800)		2 (64K)	HDLC	128	yes	STDM	2,050-4,350	local and remote switching, password protection; opt. rackmount
GENERAL DATACOMM INC.										
1223 Telex	46 (50-300)			1 (2400)	synch		no	TDM	7,500	point-to-point, rackmount
TDM 1202	96 (37.5-9600)			1 (72K)	synch		no	non-STDM	6,500	test pattern, message generator
TDM 1205	16 (37.5-9600)			1 (72K)	synch		no	non-STDM	3,600	point-to-point, rackmount
TDM 1209 Series	4 (75-9600)			1 (9600)	synch		no	non-STDM	995	point-to-point, rackmount
Gen Net 1261/4-8	4-8 (50-9600)			1 (19.2K)	X.25		no	STDM	1,330-2,090	point-to-point
Gen Net 1262/08	4 (expandable to 96) (19.2K)			1-4 (256K)	X.25 level 2		no	STDM	4,850	diagnostics

MULTIPLEXERS
TABLE 2

**MULTIPLEXERS
TABLE 2**

Company Model	Input channels			Output channels			Buffer size (K bytes)	Automatic bit rate detection?	Technique	Price (\$)	Notes, features, options
	Max. asynch (speed-bps)	Max. synch (speed-bps)	Max. asynch (speed-bps)	Max. synch (speed-bps)	Composite link protocols						
HALCYON											
4001	32 (50-9600)		1 (19.2K)	1 (9600)	X.25 level 2		yes	STDM	1,895-7,895		
4002	32 (50-9600)		1 (19.2K)	1 (9600)	X.25 level 2		yes	STDM	3,290-8,590 (8 port)		
4220	60 (50-9600)	12 (1200-9600)		2 (19.2K)	X.25 level 2		yes	STDM	4,500-21,500		
INFOTRON SYSTEMS CORP.											
790NC	over 600 (9600)	over 600 (9600)		12 (64K)	proprietary		yes	STDM	10,000-50,000	error correction diagnostics	
792NC	56 (9600)	56 (9600)		12 (64K)	proprietary		yes	STDM	5,000-15,000		
990NP	640 (9600)	640 (9600)		12 (64K)	proprietary		yes	STDM	16,000-60,000	auto path rerouting, single point network management	
992NP	56 (9600)	56 (9600)		12 (64K)	proprietary		yes	STDM	8,000-18,000	auto path rerouting, single point network management	
SM380	8 (9600)		1	1 (19.2K)	SDLC	1-2	yes	STDM	1,480	opt. 1 synch channel input with built-in modem	
SM480	8 (9600)		1	1 (9600)	SDLC	1-2	yes	STDM	1,900		
SM616	16 (9600)	(9600)			2 (19.2K)	SDLC	2	yes			1,900
SM632	32 (9600)	(9600)			2 (19.2K)	SDLC	2	yes			4,000
MEGADATA CORP.											
SM/5X	4 (up to 19.2K)	4 (up to 19.2K)	1 (up to 19.2K)	1 (up to 19.2K)	bisynch	64	no		995-2,000	self-test, polling, statistics, diagnostics, soft set-up	
MICOM SYSTEMS INC.											
M800/X.25	24 (9600)			1 (19.2K)	X.25 level 3	32	yes	STDM	2,050-6,250	opt. channels configured independently	
Micro 800/2	2-16 (9600)	4 (9600)	1 (9600)	1 (19.2K)	ADLC (HDLC-like proprietary), HDLC, BSG	16	yes	STDM	1,450-4,600	diagnostics, satellite link support, ARQ error checking	
Micro 900/2	1-16 (9600)		1 (9600)	1 (9600)	ADLC (HDLC-like proprietary)	14	no	STDM	900-4,600	diagnostics	
MINNTRONICS CORP.											
DL4-11	4 (50-19.2K)		4 (50-19.2K)		serial		no		825-1,100	switch selectable configuration	
OCTOMUX	8 (50-38.4K)		8 (50-38.4K)		serial	128	no		647-995	switch selectable configuration	
MULTI-TECH SYSTEMS INC.											
MultiMux 402	2 (110-9600)	1 (9600)		1 (9600)	modified HDLC	1-2		STDM	1,195-1,445	error checking; opt. automatic bit rate detection	
MultiMux 404	4 (110-9600)	1 (9600)		1 (9600)	modified HDLC	1-4		STDM	1,495-1,745	error checking, diagnostics; opt. automatic bit rate detection	
MultiMux 404-201B	4 (110-9600)	1 (9600)		1 (2400)	modified HDLC	1-4		STDM	1,995-2,245	error checking diagnostics; opt. automatic bit rate detection	
MultiMux 804	4 (expandable to 8) (9600)	1 (9600)		1 (9600)	modified HDLC	1-4		STDM	1,795-2,795	error checking diagnostics; opt. automatic bit rate detection	
MultiMux 808	8 (9600)	1 (9600)		1 (9600)	modified HDLC	1-8		STDM	2,395-2,645	error checking; opt. automatic bit rate detection	

**MULTIPLEXERS
TABLE 2**

Company Model	Input channels		Output channels		Composite link protocols	Buffer size (K bytes)	Automatic bit rate detection?	Technique	Price (\$)	Notes, features, options
	Max. asynch (speed-bps)	Max. synch (speed-bps)	Max. asynch (speed-bps)	Max. synch (speed-bps)						
NETWORK PRODUCTS INC.										
BabyMux	8 (up to 19.2K)		1 (9600)	1 (19.2K)	HDLC	6-16	no	STDM	1,350-2,300	error correction, full statistics, diagnostics
BabyNet	8 (up to 9600)			1 (9600)	HDLC	6-16	yes	STDM	1,450-2,400	multidrop switch retention, full statistics, diagnostics
LocalMux	8 (up to 19.2K)	8 (38.4)		1 (937.5K)			yes	STDM	850	
PARADYNE CORP.										
DCX 725		4 (1200-9600)	1 (19.2K)			4	no	STDM	4,000	point-to-point, rackmount
DCX 815	8 (50-9600)	4 (1200-9600)	1 (19.2K)		HDLC, X.25 level 2	4	yes	STDM	1,900-2,700	point-to-point
DCX 825	32 (50-9600)		1 (19.2K)		HDLC, X.25 level 2	16	yes	STDM	5,000-11,000	point-to-point
DCX 840	4 (50-9600)	2 (1200-9600)	15 (56K)		HDLC, X.25 level 2	16-64	yes	STDM	600-100,000	point-to-point, rackmount
DCX 850	4 (50-9600)	2 (1200-9600)	14 (56K)		HDLC, X.25 level 2	16-64	yes	STDM	700-150,000	point-to-point, rackmount
DCX 861	8 (50-9600)		1 (9600)		HDLC, X.25 level 2	4	yes	STDM	3,900	point-to-point, rackmount
DCX 871	32 (50-9600)	3-9 (1200-9600)	1 (9600)		HDLC, X.25 level 2		yes	STDM	3,900	point-to-point, rackmount
PENRIL DATACOMM										
6814-01	4 (75-9600)		1 (19.2K)		X.25	4	yes	STDM	1,750	diagnostics, ARQ error protection, rackmount, channels configured independently
6814-02	8 (75-9600)		1 (19.2K)		X.25	4	yes	STDM	2,195	diagnostics, ARQ error protection, rackmount, channels configured independently
PRENTICE CORP.										
SNP 1111	1 (19.2K)		1 (9600)		HDLC, X-on/X-off, HP ENQ/ACK	4	no	STDM	695	CRC error checking, channels configured independently, EIA signals
SNP 1114	4 (19.2K)		1 (9600)		HDLC, X-on/X-off, HP ENQ/ACK	4	no	STDM	1,295	CRC error checking, channels configured independently, EIA signals
SNP 1214	4 (expandable to 8 channel) (19.2K)		1 (9600)		HDLC, X-on/X-off, HP ENQ/ACK	8	no	STDM	1,495	CRC error checking, channels configured independently, EIA signals; opt. synch channel
SNP 1218	8 (110-9600)		1 (1200-9600)		HDLC, X-on/X-off, HP ENQ/ACK	8	no	STDM	1,995	CRC error checking, EIA signals, speed conversion, channels configured independently
SNP 1219	8 (110-9600)	1 (1200-9600)	1 (1200-9600)		HDLC, HP ENQ/ACK	8	no	STDM	2,595	CRC error checking, EIA signals, speed conversion, channels configured independently; opt. synch channel
SNP 1259	8 (110-9600)	1 (1200-9600)	1 (1200-9600)		HDLC, HP ENQ/ACK	8	yes	STDM	2,795	CRC error checking, EIA signal, speed conversion, channels configured independently; opt. asynch channels
RACAL-MILGO INC.										
Omnimux 4	4 (50-9600)		1 (1200-9600)		HDLC (modified)	8	yes	STDM	1,200-2,300	channels configured independently, aggregate/channel loop-back, self-test diagnostics

MULTIPLEXERS
TABLE 2

**MULTIPLEXERS
TABLE 2**

Company Model	Input channels			Output channels		Composite link protocols	Buffer size (K bytes)	Automatic bit rate detection?	Technique	Price (\$)	Notes, features, options
	Max. asynch (speed-bps)	Max. synch (speed-bps)	Max. asynch (speed-bps)	Max. synch (speed-bps)							
Omnimux 8	8 (50-9600)			1 (1200-9600)	HDLC (modified)	8	yes	STDM	1,200-2,300	channels configured independently, aggregate/channel loopback, self-test diagnostics	
Omnimux 80/160/320	32 (50-9600)	32 (1200-19.2K)		2 (1.2-72K)	HDLC (modified)	8	yes	STDM	2,475-11,700	channels configured independently, aggregate/channel loopback, test message generator, channel, link statistics	
Omnimux T-1	48 (110-19.2K)	96 (4.8-460.8K)		1 (up to 2.048M)	bit-interleaved			TDM	8,000-58,000	channels configured independently, diagnostics, redundant power and logic	
Omnimux TDM-56		8 (1.2-32K)		1 (9.6-72K)	bit-interleaved			TDM	3,200	channels configured independently, rackmount	
RACAL-VADIC											
SCOTSMAN I	8 (50-9600)		1 (9600)		modified HDLC	4-8	yes	STDM	1,850-5,100	diagnostics, error correction, channels configured independently	
SCOTSMAN II	8 (50-9600)	8 (up to 9600)	1 (19.2K)	1 (19.2K)	modified HDLC	4-8	yes	STDM	2,950-5,750	diagnostics, error correction, channels configured independently	
SCITEC CORP.											
MUX25	4 (50-9600)		1 (9600)	1 (19.2K)	X.25 level 2	2-8	yes	STDM	1,450	local, remote diagnostics; fax message, ARQ error control; opt. satellite	
NPX25	32 (50-19.2K)	8 (1200-9600)	2 (9600)	2 (9600)	X.25 level 2	2-8	yes	STDM	2,000-10,000	local, remote diagnostics; fax message, ARQ error control; opt. satellite	
NPX25-WB	16 (50-19.2K)	4 (1200-9600)	1	1 (56K)	X.25 level 2	2-8	yes	STDM	2,000-10,000	local, remote diagnostics; fax message, ARQ error control; opt. satellite	
SYMPLEX COMMUNICATIONS CORP.											
Datamizer SDC-4	4 (300-19.2K)	4 (1200-19.2K)		1 (up to 9600)	X.25 level 2, X-on/X-off	two 14.5	no	STDM		ARQ error protection, diagnostics, statistics	
TELLABS											
330A-F	32 (50-9600)	8 (1200-9600)		1-2 (up to 76.8K)	X.25 level 2	25	yes	STDM	2,400-11,900	dynamic buffer allocation; opt. local line driver interface	
331	32 (50-9600)	8 (1200-9600)		18 (up to 76.8K)	X.25 level 2	25	yes	STDM	2,900-12,900	dynamic buffer allocation; opt. line driver/receiver	
430	128 (50-9600)	128 (1200-512K)		up to 2 (up to 2.048M)	transparent			TDM	5,900	supports a variety of data channel and aggregate link options	
TELTONE CORP.											
M-860A	32 (up to 9600)	8 (1200-9600)		1 (76.8K)	SDLC, HDLC, bisynch	25	yes	STDM	2,600-7,300	self-test diagnostics, system statistics, CRC error correction	
M-860C	32 (up to 9600)	8 (1200-9600)		1 (56K)	SDLC, HDLC, bisynch	25	yes	STDM	2,800-7,500	self-test diagnostics, system statistics, CRC error correction	
M-860D	32 (up to 9600)	8 (1200-9600)		1 (76.8K)	SDLC, HDLC, bisynch	25	yes	STDM	3,100-7,800	self-test diagnostics, system statistics, CRC error correction	
TIMEPLEX INC.											
E/4	4 (up to 9600)	1		1 (up to 9600)	proprietary	16	no	STDM	1,650 and up		
E/8	8 (up to 9600)			1 (up to 9600)	proprietary	16	no	STDM	2,250 and up		
E/12	12 (up to 9600)	1		1 (up to 9600)	proprietary	16	no	STDM	3,450 and up		

**MULTIPLEXERS
TABLE 2**

Company Model	Input channels		Output channels		Composite link protocols	Buffer size (K bytes)	Automatic bit rate detection?	Technique	Price (\$)	Notes, features, options
	Max. asynch (speed-bps)	Max. synch (speed-bps)	Max. asynch (speed-bps)	Max. synch (speed-bps)						
E/16	16 (up to 9600)	1		1 (up to 9600)	proprietary	16	no	STDM	4,000 and up	
M8	8 (up to 9600)	8 (up to 9600)		2 (up to 14.4K)	X.25 level 2	up to 48	yes	STDM	2,400 and up	
M24	24 (up to 9600)	24 (up to 9600)		2 (up to 14.4K)	X.25 level 2	up to 112	yes	STDM	3,400 and up	
M48	48	48 (up to 9600)		2 (up to 14.4K)	X.25 level 2	up to 208	yes	STDM	4,200 and up	
SM8	8	8 (up to 9600)		4 (up to 19.2K)	X.25 level 2	up to 48	yes	STDM	3,300 and up	switching
SM24	24	24 (up to 9600)		4 (up to 19.2K)	X.25 level 2	up to 112	yes	STDM	4,000 and up	switching
SM48	48	48 (up to 9600)		4 (up to 19.2K)	X.25 level 2	up to 208	yes	STDM	4,400 and up	switching
WM48	up to 48 (up to 9600)	up to 48 (up to 9600)		1 (up to 72K)	proprietary	352	yes	STDM	8,000 and up	
Link/1		208 (75-576K)		up to 10 (up to 2.048M)	DSX-1, DDS		no	TDM	10,000 and up	

MULTIPLEXERS
TABLE 2

WESTERN DATACOM

Prism 1003A	3 (up to 2400)		1 (4800)		proprietary asynch	2.5	yes	STDM	875	
Prism 1003B	3 (up to 4800)		1 (9600)		proprietary asynch	2.5	yes	STDM	925	

WESTERN TELEMATIC INC.

MSU-21	2 (150-4800)		1 (9600)		asynch RS232C		no	TDM	295-590	
--------	-----------------	--	-------------	--	---------------	--	----	-----	---------	--

Information was solicited but not received from the following manufacturers:

- Black Box Corp.
- Bo-Sherrel Co. Inc.
- Digital Equipment Corp.

For information on their products, consult the Supplementary Directory of Manufacturers on page 113.

They Called It Impossible.



We Call It Micronet.™

Imagine IBM PCs, intelligent workstations and S-100 BUS multiuser systems all on the same local area network.

Impossible?

Not with MicroNet, Intercontinental Micro's networking solution.

The key is a unique hardware and software approach to local area networks.

You get the flexibility of 8-bit and 16-bit processors on the same network, the cost savings of shared peripherals, and expandability to over 4000 users.

You simply organize the network the way you want, mixing IBM PCs, S-100 BUS multi-user systems, S-100 BUS file servers, and workstations.

Intercontinental's sophisticated single board computers, 8-bit and 16-bit slaves, memory and interface boards make your job even easier. MicroNet will work with almost any S-100 BUS system including IMS, Teletex, and any other S-100 master featuring phantom deselection or extended addressing capability.

The ability to run PC-DOS, MS-DOS, CP/M, MP/M, and other applications programs means whatever the future holds, MicroNet is ready.

And so is Intercontinental Micro.

You see, our S-100 BUS products revolutionized an industry. Intercontinental's slaves, masters and memory boards introduced advanced features like Direct Memory Access and Memory Management to micro environments. MicroNet™ The new net-



working solution from the company that's been building networking solutions for years.

Still think MicroNet's impossible?

Then call, write or circle the bingo number below—we'll send you complete information on MicroNet and descriptions of all our products, including the most complete S-100 BUS product line in the business.

OUR COMPLETE MICRONET AND S-100 BUS PRODUCT LINE

CPS4800X-SINGLE BOARD COMPUTER.

4 or 6 MHz processor (Z80A/B), onboard floppy disk controller, 64K RAM, 4 channel DMA controller, 24 line parallel I/O port, two serial I/O channels, real time clock. Memory mapped or I/O mapped capability.

CPS-16X—16-BIT 8086 SLAVE PROCESSOR.

256K, 512K or 1MB RAM, bank selectable, memory mapped, two serial ports, 24 line parallel I/O port, 8 MHz.

CPS-BMX/MX—Z80 SLAVE PROCESSORS

4 to 6 MHz processors, 64K RAM or 128K bank selectable memory, two serial ports, 24 line parallel I/O port.

256KMB—MEMORY BOARD.

Hard disk cache, linear addressable to two megabytes, bank selectable in 16K increments, configures for phantom deselection, parity error detection.

LAN100—MICRONET FOR S-100 BUS SYSTEMS

ARCNET controller meets 696.2/D2S-100 spec, coax cable interface, 255 nodes per network segment, 2.5 megabit/sec. data rate.

LANPC MICRONET FOR THE IBMPC

Plug-in expansion board with custom software drivers integrates IBMPC into MicroNet networks. 64K or 256K RAM options available.

WS80X-DISKLESS WORKSTATION

Converts almost any dumb terminal into intelligent workstation with networking capability. Floppy and hard disk options available.

PERSONALITY BOARDS—

SASI, Centronix, PRIAM, Clock/Calendar, RS232, Modem, RS422, long distance serial communications (up to 4000 Ft.)



4015 Leaverton Ct., Anaheim, CA 92807, (714) 630-0964, TELEX: 821375 SUPPORT UD

TurboDOS is a Trademark of Software 2,000, Inc. ARCnet is a Trademark of Datapoint. CP/M, CP/M 86, MP/M, MP/M 86, CP/M PLUS, Concurrent CP/M 86 are Trademarks of Digital Research. PC-DOS, IBM-PC are Trademarks of International Business Machines. MS-DOS is a Trademark of Microsoft. TurboLAN, MicroNet are Trademarks of Intercontinental Micro Systems.

CIRCLE NO. 25 ON INQUIRY CARD

EMERGING STANDARDS TRIGGER \$3B LAN MARKET

Finally the software is here that allows LANs to fulfill the promise of shared data

Carl Warren, Western Editor
and Rick Dalrymple, Senior Editor

The first flurry of publicity on local area networks (LANs) appeared in 1980. Now, in 1985, LAN sales may actually begin their promised rise to a multibillion dollar market. Early in 1984, Future Computing of Richardson, Texas, predicted that by 1988 personal computer-LAN sales alone would reach \$1.5 billion. But in September, when major developments in networking software were being announced, the market research company revised its forecast for the personal computer segment of the LAN market to predict sales of \$3 billion by 1987.

Prior to last year, to paraphrase the old real estate adage, the LAN market lacked three things: standards, standards and standards. This year, the long-awaited standards are finally emerging. Among the "standards" that are losing their quotation marks and becoming officially recognized are Ethernet (IEEE 802.3), token-passing bus (IEEE 802.4), token-passing ring (IEEE 802.5) and, in software for PC-LANs, Networks 1.0 from Microsoft Corp., Bellevue, Wash.

"Businesses want to be able to plug any computer into any local area network, like you can plug any lamp into any wall socket without anything blowing up," points out Amy Wohl, president of Advance Office Concepts, Bala Cynwyd, Pa. Toward that end, LAN vendors are beginning to deliver on their early promises that their products would be a magic link connecting all types and brands of computers.

In 1984, several Ethernet vendors announced networking software that connects the network

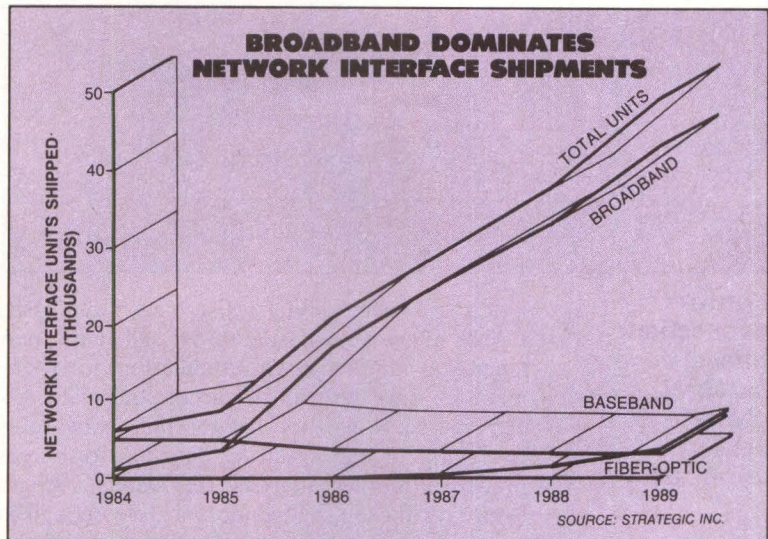

user to the operating system of most popular minicomputers and the IBM Corp. PC. With these software packages, an Ethernet user with an IBM PC can communicate with a Digital Equipment Corp. (DEC) VAX as though he were connected directly to that computer with a DEC VT100 terminal. The reverse is also possible: A user with a VT100 terminal connected to the VAX can access the network and communicate with the IBM PC. The caveat, of course, is that the user must be conversant in the language of the addressed computer and be proficient in operating all those software programs he chooses to call up on the addressed computer.

The new software is a significant step toward linking different computer systems together. For many users, however, the need for competence in several different operating systems made the

Network interface unit shipment forecasts do not include network interface boards for personal computers.

arrangement too complicated. Those users will have to wait until application software developers take advantage of these Ethernet software packages by building application-specific utilities on top of the networking software.

Networking software unlocks the market

Prior to networking software, LAN vendors were trying to sell networking hardware as a solution in itself. During this period only two

the functions these firms first implemented on printed circuit boards are now integrated on a set of silicon chips.

As Ethernet hardware has evolved, network vendors have been able to cut interface costs. Prices for Ethernet interfaces are continuing to fall. According to a forecast from Strategic Inc., Cupertino, Calif., network interface units will fall in price from around \$900 today to less than \$400 by 1989. These lower prices, along with an increasing number of application-specific network software utilities, should make Ethernet the network of choice in high-volume data environments.

Token bus automates the factory

Attendees at the June 1984 National Computer Conference (NCC) in Las Vegas saw a demonstration of what probably will be the LAN of the factory—IEEE 802.4 token bus. Six factory automation vendors used the token bus to communicate with automated equipment in a booth sponsored by General Motors Corp. GM is working closely with all token bus network vendors and those firms planning to use the network in factory automation applications, and is clearly promoting the standard.

Two major features make the token bus more attractive than Ethernet in factory-automation applications. First, the broadband token bus can transmit television signals, allowing the user to see how the robot is responding to instructions sent over the network. This is done over closed-circuit TV cameras and monitors. Second, Ethernet is only able to transmit signals over a distance of about 2½ kilometers. The token bus is able to transmit signals over much greater distances.

As Ethernet and the token bus were evolving into IEEE standards, a group of people became interested in developing a third standard. This led to the specifications for the token ring—IEEE 802.5. The token ring is associated with last year's now-famous IBM LAN nonintroduction. IBM announced that it would not introduce its token-passing ring LAN for at least two years. IBM publicly demonstrated the token-passing baseband ring technology at Telecom '83 in Geneva, Switzerland (MMS, January 1984, Page 31).

According to David Potter, Interlan's vice-president of research and development at Westford, Mass., and an Ethernet advocate, "IBM appears to be attempting to differentiate itself from Xerox by the adoption of the token ring." While an IEEE standard does exist, the characteristics and marketplace for the token

LOCAL AREA NETWORKS

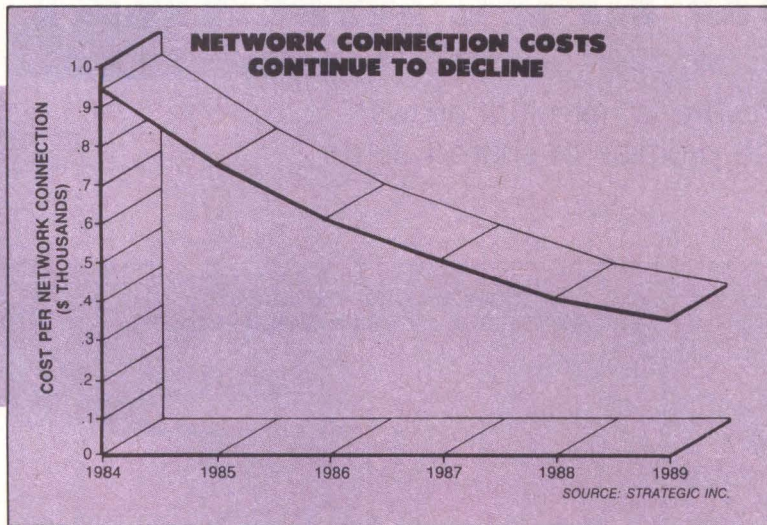

Network connection prices are for multiuser computer network interfaces only.

kinds of overlapping customers purchased LANs: those who desperately needed the new technology and those who could afford to experiment—hardly the mainstream of potential LAN customers. Now that networking software is beginning to make sharing data and resources practical, market analysts are seeing a bright future for those LAN vendors nimble enough to leverage the emerging standards to their advantage.

Probably none of the recently adopted IEEE network standards will totally dominate the LAN market. So far, the favored standard in scientific and engineering applications is Ethernet—IEEE 802.3. Already compatible with almost all minicomputers, Ethernet's 10M-bit-per-second (bps) transmission speed is well suited to the heavy data traffic typically found in scientific and engineering environments.

Early on, Ethernet enjoyed the support of three large corporate backers—DEC, Intel Corp. and Xerox Corp. These corporate backers were joined by the early Ethernet vendors: Advanced Computer Communications, Interlan Inc., 3Com Corp. and Ungermann-Bass. Together these firms pioneered the development of Ethernet hardware interfaces. Today many of

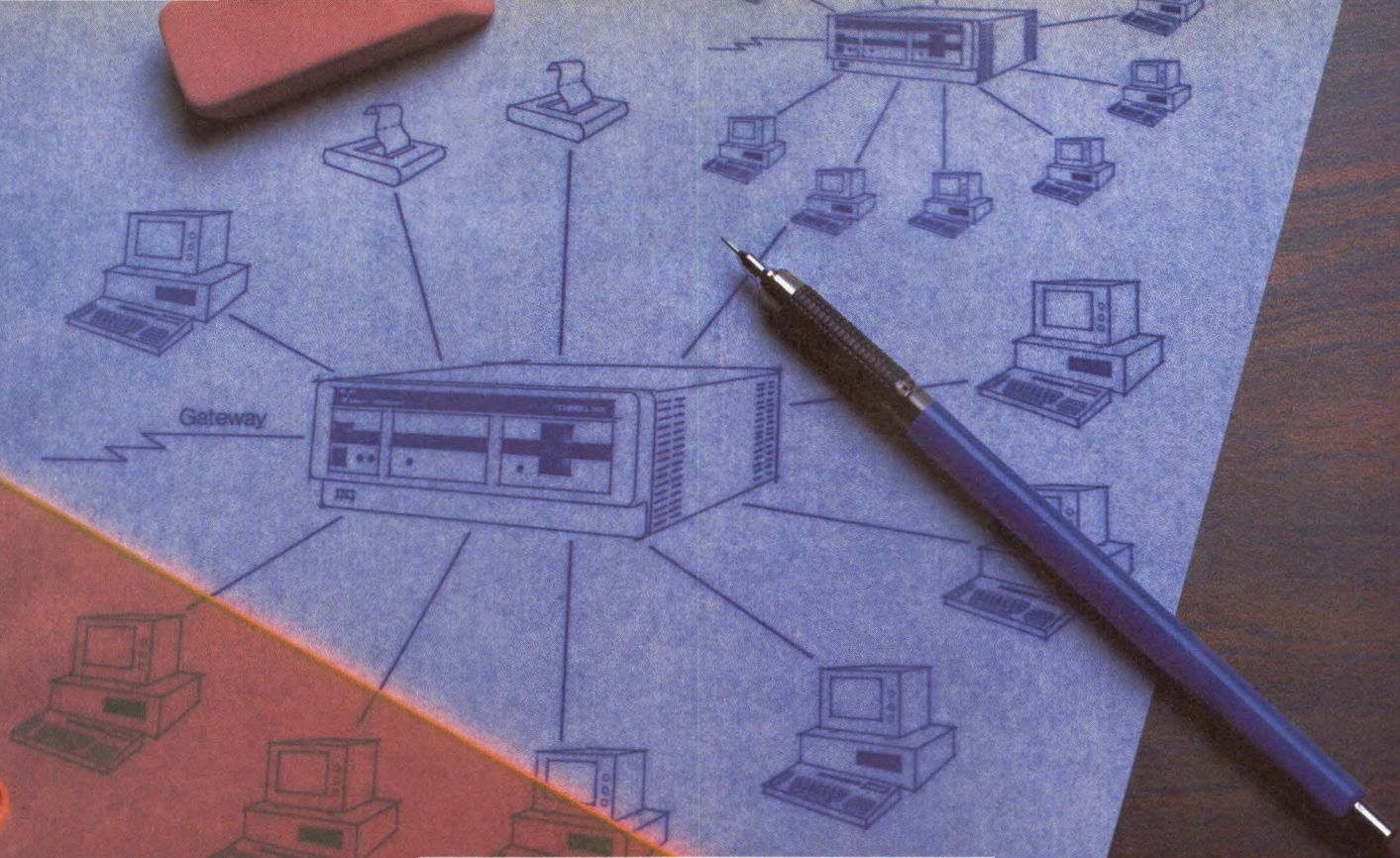

PLAN ON MAKING THE MOST OF YOUR PC CAPABILITIES WITH THINKLINK.™

Now you can protect your growing investment in PC workstations with a small investment in common sense – The ThinkLink System produced by Tangent Technologies.

ThinkLink is more than a network. It is a system that provides increased levels of productivity that stand alone PC's just can't deliver.

Forget the mumbo jumbo of complex commands. ThinkLink simplifies the storage and access of information with advanced functions like shared data bases, real distributed processing and integrated workbenches which support applications like project management. This encourages greater use of individual PC's. Which means you get more for your PC investment.

Advanced ThinkLink features like electronic mail, schedule organizer, on-line calculator, spread sheet accounting and electronic bulletin board

help your business professionals get more work done in less time. ThinkLink applications also permit users to share software, reports, and other needed information which provides increased productivity department-wide.

For superior functionality, performance, and the best return on your PC investment dollar, think ThinkLink. For more information, call or write John Dashner, V.P. of Marketing, Tangent Technologies, 5720 Peachtree Parkway, Suite 100, Norcross, Georgia 30092. (404) 662-0366.



CIRCLE NO. 26 ON INQUIRY CARD

When you want the ASCII terminal that leads the field in performance, we'll be there.

Now there's an affordable all-purpose editing terminal that's ahead of the pace in quality, performance, and reliability: Qume's new QVT 109™. It comes to you with a full *one-year* warranty. Though that's twice the warranty of most other ASCII terminals, over 98% of our customers never need it. Qume quality control is *that* good.

The QVT 109 also leads the pack in performance, with 19 programmable function keys (38 functions) that can perform a sequence of tasks at a keystroke. There's a capacitive keyboard that combines the responsive touch of a typewriter with ruggedness that stands up to heavy-duty, all-day use. What's more, you're backed by our nationwide service network, as well as our vast resources and solid experience as an ITT company. You can depend on Qume to keep pace with your needs in the years ahead.

For more information about Qume's new QVT 109, our other alphanumeric and graphics terminals, or our full line of daisywheel printers and disk drives, call (800) 223-2479. Or write Qume Corporation, 2350 Qume Drive, San Jose, CA 95131.

Qume[®]
A Subsidiary of ITT

CIRCLE NO. 27 ON INQUIRY CARD

QVT
109™

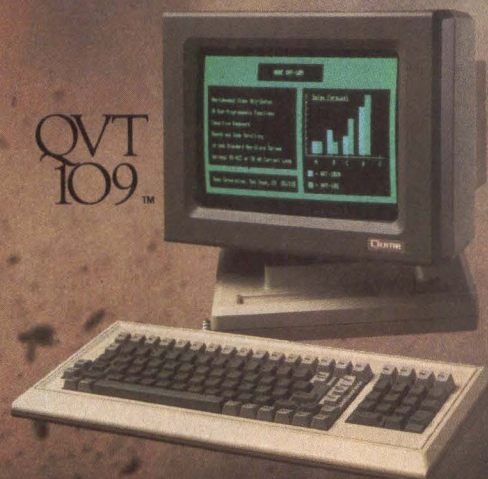

ring is presently unclear. What is clear is that any time IBM adopts a standard it generally has a significant impact on the marketplace.

IBM boosts PC-LAN market

Whether by design or accident, IBM has given PC-LAN vendors a much-needed shot in the arm. As with many other computer products, LANs for personal computers need IBM's blessing. With the announcement that the introduction of the IBM token-ring LAN was two years away and that, in the interim, the company would be marketing its PC Network (MMS, October 1984, Page 37), LAN customers were given a better understanding of their networking options.

IBM's PC Network is designed to offer peer-to-peer communications in offices and small businesses by joining together combinations of the PC, PC/XT, Portable Personal Computer and PC-AT. The network links as many as 72 personal computers, enabling them to share information, programs, messages, printers and mass-storage devices. For LAN vendors, however, the most exciting aspect of the PC Network is the software—the PC Network Program which runs under IBM PC-DOS 3.1.

IBM PC-DOS 3.1 is IBM's implementation of Microsoft's MS-DOS 3.1. When IBM an-

nounced its PC Network, Microsoft's Networks 1.0, which runs under MS-DOS 3.1, became an instant industry standard, supported by approximately two dozen computer manufacturers and LAN vendors (MMS, February, Page 47). Microsoft claims that any program written for MS-DOS 3.1 can run under IBM's PC-DOS 3.1. Microsoft has also announced its own LAN, MS-NET, based on MS-DOS 3.1, but according to 3Com president Bill Krause, "MS-DOS 3.1 is the only significant part of MS-NET because that is the part that IBM is using."

The key development that excites IBM's competitors is that they do not need to use IBM's LAN hardware because, according to Microsoft, Networks 1.0 is hardware-independent. This means that LAN vendors can substitute their own network board in place of IBM's and use all the multiuser application software being written for the PC Network operating system. For example, a customer could use one of the network interface boards manufactured by an Ethernet vendor for the IBM PC and link not only IBM PCs (and PC-compatibles) via Ethernet, but also PCs from DEC, Texas Instruments Inc. or Hewlett-Packard Co., as well as several popular minicomputers. In addition, an Ethernet network could transfer data at speeds up to 10M bits per second (bps) versus the 2M-bps transfer rate

PABXes endowed with new functions

No longer can the programmable automatic branch exchange (PABX) be dismissed as a fancy telephone switch. Today's PABXes offer all of the telephone functions previously associated with these systems plus some significant new capabilities that make them attractive alternatives to LANs.

One example of the versatility available in the newer PABXes is found in Intecom Inc.'s IBX LANmark. Intecom, Allen, Texas, has been a pioneer in developing high-speed internal packet switching, as opposed to the usual telephone-circuit switching, to transfer data between nodes in a network. Intecom claims its Integrated Business Exchange (IBX) Ethernet LAN can achieve speeds up to 10M bits per second (bps) over standard twisted-pair telephone wire, thus eliminating the need to install more-expensive coaxial cable.

LANmark Ethernet may be used to extend existing Ethernet systems, to connect many different Ethernet systems together or to serve as the entire Ethernet connection infrastructure for the different workstations within a system.

The IBX LANmark system provides the capability

for all IBX electronic telephone instruments to attach to Ethernet devices via the 15-pin Ethernet "D" subminiature connector. The electronic telephone instrument routes the information in packets through the IBX to the receiving device, which may be another electronic telephone instrument or a connection to another Ethernet segment. With this scheme, Ethernet workstations may be moved to any location where an IBX telephone jack is installed.

According to Dave Potter, vice-president of research and development at Interlan Inc., Westford, Mass., a coaxial-based Ethernet vendor, "PABXes make sense for office automation functions such as word processing, electronic mail and electronic calendars, and should coexist peacefully with coaxial-based engineering and scientific-oriented LANs." Most LAN industry observers hold the opinion that the PABX has won a place in the office of the future by virtue of its capabilities alone. By adding data transmission, a PABX can be configured to handle almost any office automation application by exploiting the reach and flexibility of standard telephone wire.

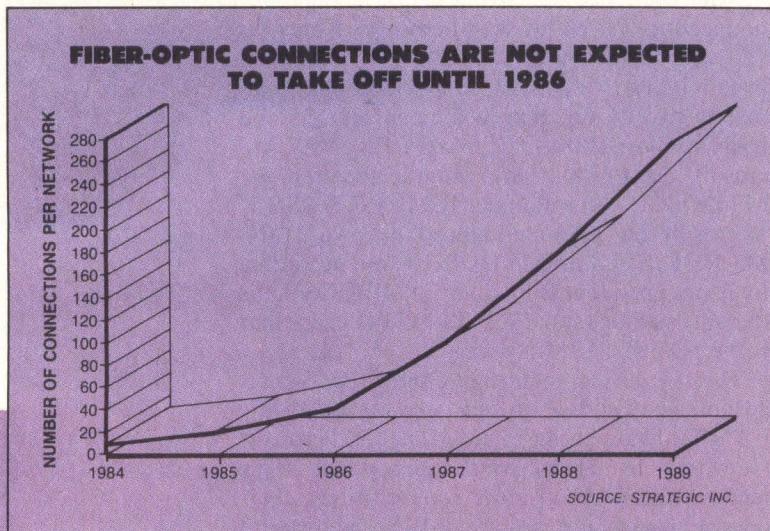

Strategic Inc.'s market analysts believe connection costs are currently too high for fiber-optic networks. If, as expected, a new tap technology reduces connection costs, fiber-optic connections should take off.

specified for the IBM PC Network.

LAN vendors can achieve compatibility for their network cabling and interface boards provided their interface and driver software are implemented up to Layer 4, the transport layer of the Open Systems Interconnection (OSI) network standard model defined by the International Standards Organization (ISO). Microsoft's group manager for systems product marketing, Leo Nikora, says LAN vendors may follow IBM's lead and implement some of the Networks 1.0 functions in firmware for faster performance.

According to International Data Corp., Framingham, Mass., only 15,800 PC-LANs were shipped in 1983, and an estimated 25,000 in 1984. These are not impressive numbers considering the millions of installed PCs but, 1985 may prove to be the year in which the LAN marketplace finally lives up to its potential. □

Interest Quotient (Circle One)
High 456 Medium 457 Low 458



Think of a Viking workstation as another way to add value.

If you're not integrating ergonomic support furniture in your system, you may be missing an easy way to increase margins and add even more value. Users don't like shopping around to complete the system any more than you do. Try buying a good workstation in your area sometime. It's tough, and it sometimes opens the door to competition and criticism.

We think a lot of users care about the system environment, and well-designed support furniture can make your system more comfortable. And therefore more useful and productive.

Call us on our toll-free line. Everyone wins: users get good furniture at no more cost; you increase margins; and we win through economy of scale, even if the scale is just a few units a month.

Call today, or write our OEM Department:
Viking Acoustical, Airlake Industrial Park,
Lakeville, MN 55044. 612/469-3405, or Telex 290693.

VIKING

Call toll free
1-800-328-8385

CIRCLE NO. 28 ON INQUIRY CARD

This Publication is available in Microform.

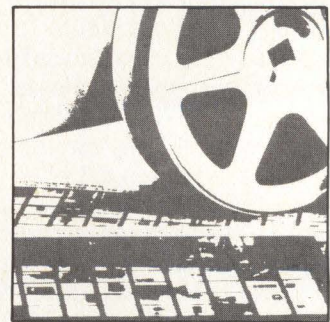

University Microfilms International

Please send additional information for _____
Name _____
Institution _____
Street _____
City _____
State _____ Zip _____

300 North Zeeb Road
Dept. P.R.
Ann Arbor, Mi. 48106

CIRCLE NO. 29 ON INQUIRY CARD

MINI-MICRO SYSTEMS/February 15, 1985

Name-dropping just isn't enough to impress the network critics.

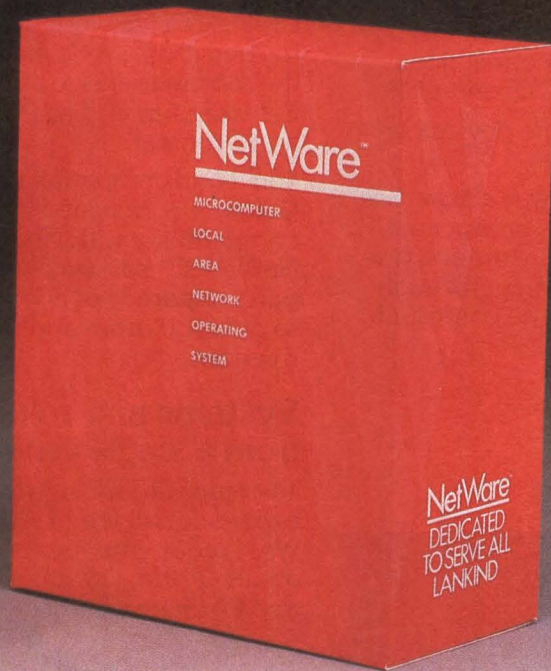

Now that the local area network (LAN) industry is booming, some pretty big names in the computer business are jumping on the bandwagon. Their goal is simple: get a LAN on the market and let all those who pay homage to The Name run out and buy it.

At Novell, we don't have a big name to drop when selling NetWare, our high-performance LAN operating system. So we let our technology do the talking. And the network critics are not only listening, they are taking notice.

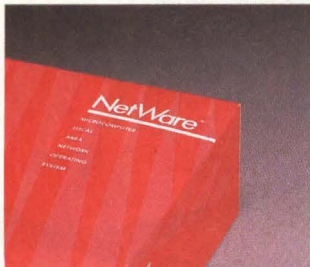

Performance.

No LAN operating software outperforms NetWare. With speed, flexibility, security and

hundreds of multiuser applications, NetWare sets a standard for the entire LAN industry.

Versatility.

NetWare is more than a LAN operating system. Currently, NetWare software is available for 24 LAN hardware systems. Plus, four complete LAN systems are sold and serviced by Novell.

Compatibility.

Because NetWare is compatible with DOS 3.1, it can run any application written for the IBM PC Network Program. And NetWare greatly increases IBM PC Network performance and applications software useability.

Internetworks.

Using bridges, NetWare can connect separate LAN systems into one large internetwork. In fact, every LAN Novell supports can be interconnected—any number, in any of the various topologies.

Remember the name.

The one LAN system making a big impression on the network critics is the one with the not-so-big name: NetWare, from Novell. Remember it when you want a high-performance LAN instead of a high-powered name.

For more information, call or write:



Novell

Novell, Inc. 1170 N. Industrial Park Drive,
Orem, Utah 84057 (801) 226-8202

PC Communications

The experts at Gateway know Networking from top to bottom

When it comes to networking, turn to the company whose business is communications. At Gateway, we provide more than the tip of the iceberg. Our communications systems expertise and networking approach takes the uncertainty out of networking by providing a complete solution. Whether your requirement is a local area network supporting multi-user applications; a LAN connected to another LAN, host, or remote device using X.25 and/or SNA; we provide the hardware, software, systems integration, and service to help you integrate the IBM PC™ and compatible PCs into a complete communications system for your customers.

Solutions for your communications problems

Regardless of your LAN, Gateway gives you a total solution for your networking applications. Our unique Network Access Method gives you:

- LAN to LAN connections (either bridges or gateways)
- LAN to host connections supporting X.25 and SNA
- LAN to remote device connections

In fact, with Gateway's expertise and our complete product set, you'll give your customer a true systems environment through micro to mainframe communications.

Quality and features no other manufacturer can match

Gateway backs its technical experience with systems that have been proven reliable and innovative. In a benchmark by Novell™, Gateway's G/NET™ Local Area Network outperformed most LANs including the more expensive 3COM Ethernet™, as well as PCNET™ and Omnetnet™.

You'll find compatibility, too. Gateway is designed for full compatibility with Novell NetWARE™ software which supports hundreds of applications to give you more application freedom.

Systems and solutions from a single vendor

Team up with the networking experts for all your LAN and WAN requirements. Ask us about G/NET, G/X25™, G/SNA™ and PC/Supercharger™.

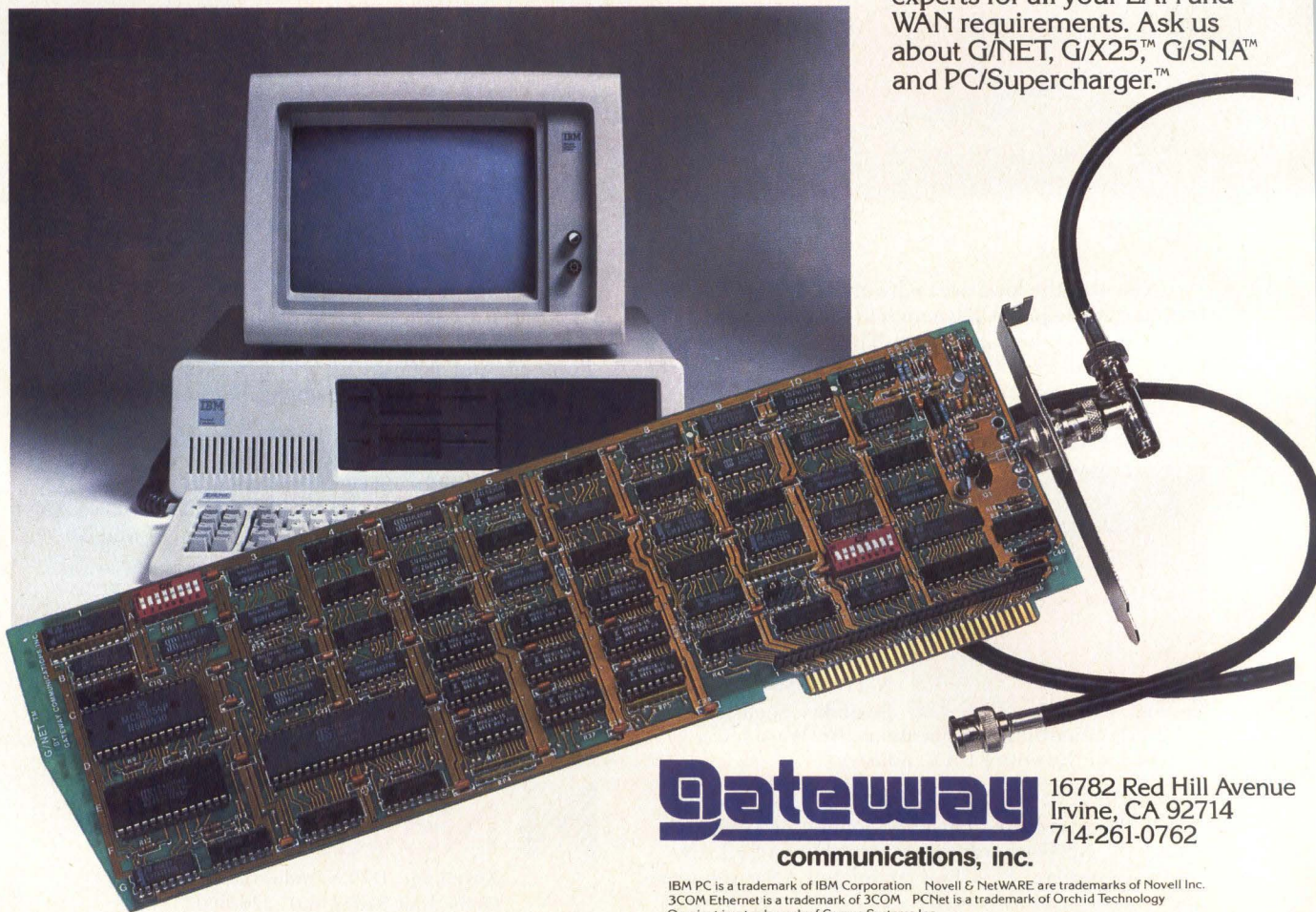

Gateway
communications, inc.

16782 Red Hill Avenue
Irvine, CA 92714
714-261-0762

IBM PC is a trademark of IBM Corporation. Novell & NetWARE are trademarks of Novell Inc.
3COM Ethernet is a trademark of 3COM. PCNet is a trademark of Orchid Technology.
Omnetnet is a trademark of Corvus Systems Inc.

Resellers, circle 150 for more information

End users, circle 151 for more information

The LAN Is Only The Tip Of The Iceberg

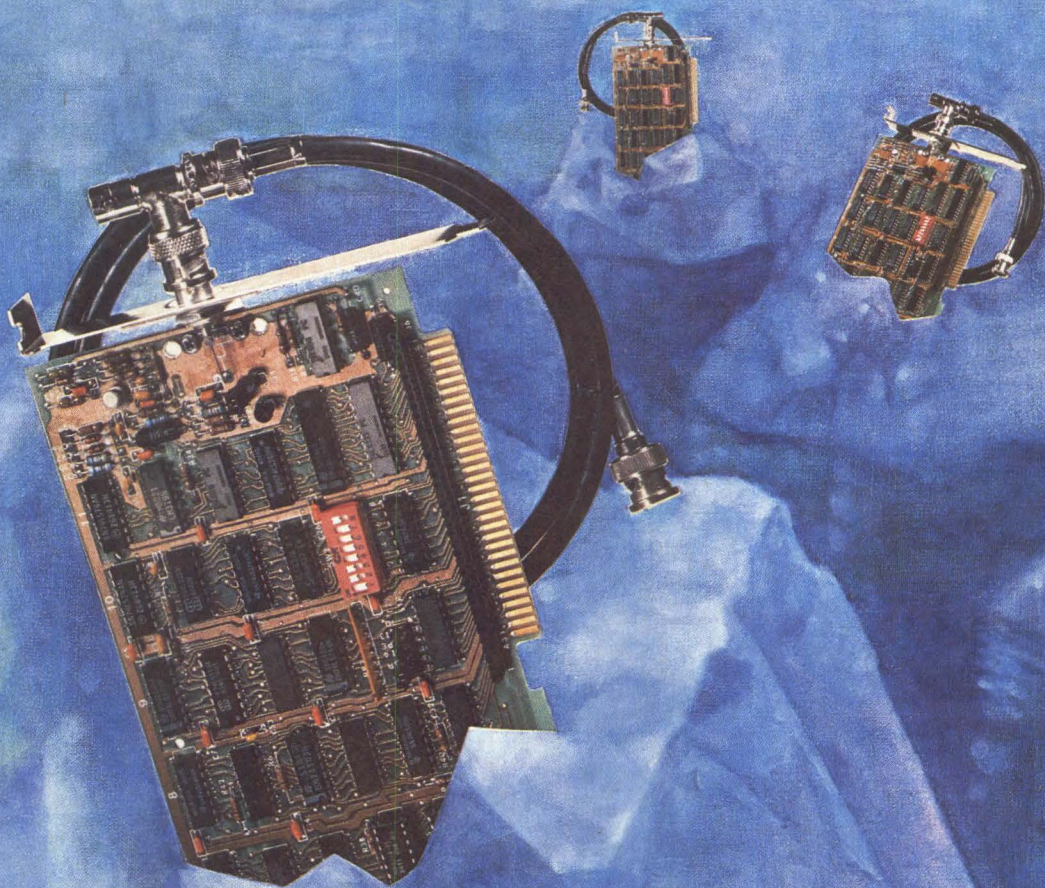

GATEWAYS

BRIDGES

MICRO TO MAINFRAME

X.25

SNA

FILE SERVERS

ELECTRONIC MAIL

LOCAL AREA

TABLE 3

LOCAL AREA NETWORK

Company Network name	Networking media	Network access	Data rate (bps)	Max. no. stations max. distance (end to end)	Gateways available
APPLITEK CORP.					
UniLAN	broadband	proprietary	1.54M	40,000 stations; 30 miles	Ethernet, X.25
UniLAN	baseband	proprietary	1.54M	1,000 stations; 2.5 miles	Ethernet, X.25
UniLAN	fiberoptic	proprietary	1.54M	1,000 stations; unlimited	Ethernet, X.25
AST RESEARCH INC.					
AST-PCnet	baseband	CSMA/CD	800K	223 stations; 5,000 feet	AST 3780 RJE
AST-PCnet II	twisted-pair	CSMA/CA	800K	160 stations; 3,500 feet	AST 3780 RJE
BRIDGE COMMUNICATIONS INC.					
Ethernet	baseband	CSMA/CD, IEEE 802.3	10M	100 stations; 2,500m	X.25, Bridge Communications GS/1, GS/3
CODENOLL TECHNOLOGY CORP.					
Codenet-Fiber Optic Ethernet	fiberoptic	CSMA/CD, IEEE 802.3	10M	1,024 stations; 2.8 km	
COHERENT COMMUNICATIONS SYSTEMS CORP.					
Linemate 192	broadband, twisted-pair	transparent format or protocol	19.2K	unlimited stations; 7 miles	
3COM CORP.					
EtherSeries Network	baseband	CSMA/CD	10M	1,024 stations; 2.5km	EtherTerm (emulates DEC TTY, VT52, VT100)

NETWORKS

NETWORK INTERFACE HARDWARE

Network interface model name	Interface product type	Computers supported	Ports	Buffer memory size (bytes)	Networking software	Price (\$)
NI10/T	box	all computers	16 asynch, 16 synch, 4 IEEE 488, 4 parallel	256K	included	
NI10/T	box	all computers	16 asynch, 16 synch, 4 IEEE 488, 4 parallel	256K	included	
NI10/T	box	all computers	16 asynch, 16 synch, 4 IEEE 488, 4 parallel	256K	included	
AST-PCnet	board	IBM PC/XT/AT and compatibles	none	none		1,090
AST-PCnet II	board	IBM PC/XT/AT/PCjr and compatibles	none	none		1,090
CS/1-A	box	any asynch ASCII terminal or host port	32 asynch	128K	opt. SW/1-A/BSC software (\$150)	9,900-15,600
CS/1-AX	box		32 asynch			
CS/1-BSC	box	bisynch terminal or host ports, IBM, Honeywell, Sperry, Control Data Corp.	32 synch	128K	opt. SW/1-A/BSC software (\$150)	9,900-15,600
CS/1-BSCX	box		32 synch			
CS/1-HSM	box and board	DEC VAX 11/7XX	none	128K	opt. SW/1-HSM software (\$150)	15,500
CS/1-SNA	box	IBM 4300, 303X, 308X	1 synch	128K	SW/1-SNA (IBM 3270) software (\$1,000)	14,000
CS/1-X.25	box	Prime, Tandem, Hewlett-Packard	2 synch	128K	opt. SW/1-X.25 software (\$2,000)	10,500
CS/100-488	box	any IEEE 488-compatible	1 IEEE 488	128K	SW/100-488 software (\$150)	5,100
CS/100-A	box	any ASCII asynch terminal or host ports	14 asynch	128K	SW/100-A/BSC software (\$150)	3,900-5,100
CS/100-AX	box		14 asynch		SW/100-NCS software (\$1,500)	3,600-5,100
CS/100-BSC	box	bisynch terminal or host ports, IBM, Honeywell, Sperry, Control Data Corp.	10 synch	128K	SW/100-A/BSC software (\$150)	3,900-5,100
CS/100-BSCX	box		10 synch		SW/100-NCS software (\$1,500)	3,600-4,600
Gateway Servers/1	box		4 synch	128K	opt. SW/2-CS/ICS software (\$2,000)	10,500
Gateway Server/3	box		8 synch	128K	opt. SW/3 software (\$300)	10,500
NCS/100	box		none	128K	SW/100 NCS software (\$1,500)	4,900
Codelink-2000	board	Ethernet-compatible computers	1 asynch, 1 IEEE 488			595-1,024
Codelink-3000	box	Ethernet-compatible computers	1 asynch, 1 IEEE 488			595-1,024
SPM-192C	board	any computer with RS232C port	1 asynch, 1 synch, 1 IEEE 488, 1 parallel	none	none	175-195
SPM-192R	box	any computer with RS232C port	1 asynch, 1 synch, 1 IEEE 488, 1 parallel	none	none	200-245
EtherLink 3C500B	board	IBM PC/XT/AT, Compaq DeskPro, AT&T PC			EtherShare (\$395); opt. EtherPrint (\$150), EtherMail (\$550), EtherStart (\$100)	650

LOCAL AREA NETWORKS
TABLE 3

LOCAL AREA NETWORK

Company Network name	Networking media	Network access	Data rate (bps)	Max. no. stations max. distance (end to end)	Gateways available
COMMTX INC.					
Cx-Net	twisted-pair, coaxial	Datapoint Arcnet		unlimited stations	X.25, IBM 3274 BSC, SNA/SDLC
COMMUNICATIONS MACHINERY CORP.					
Ethernet	baseband	CSMA/CD, IEEE 802.3	10M	1,024 stations; 2,500m	
COMPLEX SYSTEMS INC.					
XLAN	baseband, twisted-pair, coaxial	CMSA/CA	1M	192 stations; 8,000 feet	
CONCORD DATA SYSTEMS INC.					
Token/Net	broadband	token-passing		5M	up to 1,000 stations; up to 25 miles
CORVUS SYSTEMS INC.					
Omninet	baseband, twisted-pair	CSMA/CA	1M	64 stations; 4,000 feet	SNA
CYB SYSTEMS INC.					
Unite	baseband, twisted-pair	CSMA/CD, IEEE 802.3	10M	255 stations; 1,500 miles	

TABLE 3

NETWORK INTERFACE HARDWARE

Network interface model name	Interface product type	Computers supported	Ports	Buffer memory size (bytes)	Networking software	Price (\$)
Cx-83	box	all ASCII asynch, IBM BSC or SNA, Control Data and Honeywell supporting IBM 3270	10 asynch, 2 synch (3274), 1 synch (X.25), 20 coaxial	64K		3,900-5,750
Cx-86	box	all ASCII asynch, IBM BSC or SNA, Control Data and Honeywell supporting IBM 3270	25 asynch, 2 synch (3274), 1 synch (X.25), 25 coaxial	192K		5,850-12,750
Cx-Net	box (2)	all ASCII asynch, IBM BSC or SNA, Control Data and Honeywell supporting IBM 3270	125 asynch, 10 synch (3274), 5 synch (X.25), 125 coaxial	2M		8,400-75,000
ENP-10	board	Motorola VME/10, Ironics, Mostek, computers with UNIX operating systems		128K	K-1 Kernel Communications Executive Software	2,050-3,150
ENP-20	board	Motorola EXORmacs, Charles River Data Systems, computers with UNIX operating systems	2 asynch	128K	K-1 Kernel Communications Executive Software	1,950-3,000
ENP-30	board	Callan, Masscomp, computers with UNIX operating systems	2 asynch	128K	K-1 Kernel Communications Executive Software	1,550-2,400
ENP-44	board	DEC VAX, PDP-11	2 asynch	128K-512K	K-1 Kernel Communications Executive Software	2,550-3,900
IP-3	box	any asynch RS232C ASCII port	3 asynch, 2 parallel	16K	included	258-430 (port)
HR 105	box	any computer with RS232C, RS449, RS422 port	none	none		
RF modem, access unit, control unit	3 board set	any computer with RS232C, RS449, RS422 port	4 asynch, 4 synch	8K-64K	included	600 (port)
TIM 200	box	any computer with RS232C, RS449, RS422 port	4 asynch, 4 synch, (2) RS449, RS422	8K-64K	included	500-700 (port)
TIM 220	box	any computer with RS232C, RS449, RS422 port	12 asynch, 12 synch, (2) RS449, RS422	8K-64K		500-700 (port)
Apple	board	Apple IIe, III, Macintosh	none	none	opt. Constellation software (\$150-495)	495
DEC Rainbow	board	DEC Rainbow	none	4K	opt. Constellation software (\$150-495)	495
IBM PC	board	IBM PC/XT/AT/jr.	none	4K	opt. Constellation software (\$150-495)	495
Zenith Z100-150	board	Zenith Z100-150	none	4K	opt. Constellation software (\$150-495)	495
Unite 1i	box	IBM PC/XT/AT and PC compatibles	2 asynch, 2 synch, 1 parallel	256K-1.5M	included	8,995
Unite 4i	box	IBM PC/XT/AT and PC compatibles	6 asynch, 6 synch, 1 parallel	256K-1.5M	included	9,995
Unite 8i	box	IBM PC/XT/AT and PC compatibles	10 asynch, 10 synch, 1 parallel	256K-2.5M	included	16,995
Unite 16i	box	IBM PC/XT/AT and PC compatibles	18 asynch, 18 synch, 1 parallel	256K-4.5M	included	24,445
Unite 32i	box	IBM PC/XT/AT and PC compatibles	34 asynch, 34 synch, 1 parallel	256K-8.5M	included	53,995

TABLE 3
LOCAL AREA NETWORKS



If you've looked at other data switches then you already know how big and bulky they can be. Some require racks as high as six feet and weigh as much as 600 pounds. And almost all of them need a forklift just to move them about.

But with Emulex's CommXchange you have a lean, compact design. One that can easily be moved around and weighs one sixth as much as those other bulky models.

In fact, the only time other data switches look light-weight next to CommXchange is when you start comparing features and benefits. That's when the CommXchange becomes a heavyweight.

*DEC and VAXcluster are registered trademarks of Digital Equipment Corporation.

NOW, VIRTUALLY ANY TERMINAL CAN ACCESS ANY CPU, PARTICULARLY DEC'S* MINI-COMPUTERS AND VAXCLUSTER SYSTEMS.

The CommXchange is an advanced, microprocessor-based data switching system designed to let you effortlessly tie together large groups of terminals to one or more computers. It allows essentially any asynchronous terminal to selectively communicate with a variety of host computers. This means you can now build on the investment you have already made on existing equipment. You'll also improve efficiency, since users no longer have to take turns at terminals or waste time going from one office to another to use a terminal dedicated to a particular computer.

REALIZE OPTIMUM TERMINAL SWITCHING FLEXIBILITY. A basic CommXchange is capable of routing 360 terminals and computer port lines. Thanks to a port contention feature, there can actually be a larger number of terminals attached to the system than computer ports. This allows the ports to be shared by a number of part-time terminal users, reducing the need to add costly multiplexers as a user's terminal requirements expand. You can add expansion units for an additional 960 lines. And all lines can run simultaneously at speeds up to 9600 bps.

DELIVER A NETWORKING DATA SWITCH... WITHOUT A FORKLIFT?

INTRODUCING COMM^XCHANGE.

**A COMPLETE DATA SWITCH THAT CONNECTS
TERMINALS TO MULTIPLE COMPUTERS.**

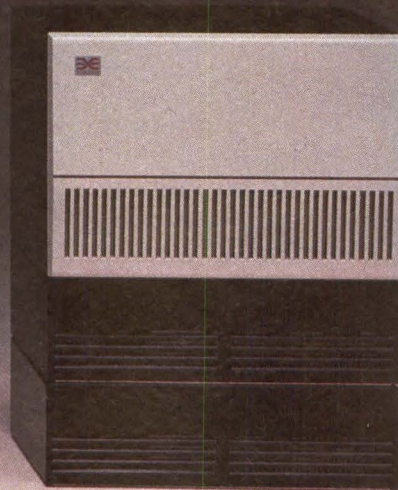

**GET COMPLETE REDUNDANCY, ACCESS
SECURITY AND TOTAL NETWORK CONTROL.**

From the day you put your CommXchange network on line, you will be able to count on maximum reliability. The CommXchange is configured with standby logic modules and dual power supplies that will keep the system operating despite component failure. Security is assured because access is limited to specific passwords, and any unauthorized access attempts are logged. And the CommXchange produces a transaction log that gives you a continuous and accurate record of all network traffic.

**INSTALLATION, CONFIGURATION AND
OPERATION ARE A SNAP.** CommXchange is so easy to install, it can be done

by a telephone installation crew using ordinary telephone wire and connectors. To configure your system, simply connect your terminal to the supervisory control board located within the central unit. Menu-driven software provides step-by-step instructions for routing terminal lines to designated computers. And once the system is configured, users are able to request access to available computers by sending simple keyboard commands from their terminals.

LET'S NOT FORGET LOW-COST AND COMPATIBILITY WITH ALL CURRENT EMULEX COMM CONTROLLERS. If you're looking for a competitively-priced, high-

performance data switching system that allows large numbers of terminals to be linked between several host adapter computer systems, then talk with Emulex. And if you're using any of our current communications multiplexer products, they work perfectly with the CommXchange. Not only can we deliver the right solution with our CommXchange, we can do it without a forklift.

Call toll-free (800) 854-7112.
In California (714) 662-5600. Or write:



Emulex Corporation,
3545 Harbor Boulevard,
P.O. Box 6725,
Costa Mesa, California,
92626.

CIRCLE NO. 32 ON INQUIRY CARD

LOCAL AREA NETWORK

Company Network name	Networking media	Network access	Data rate (bps)	Max. no. stations max. distance (end to end)	Gateways available
DATA GENERAL CORP.					
Ethernet	baseband	CSMA/CD	10M	1,024 stations; 2,500m	bisynch, SNA, X.25
Multiprocessor Communications Adapter	parallel bus	proprietary		4-15 stations; 30-140 feet	bisynch, SNA, X.25
Network Bus System (NBS)	baseband	token-passing, proprietary	2M	32 stations; 1 mile	bisynch, SNA, X.25
DATAPOINT CORP.					
ARC LAN	baseband	token-passing	2.5M	255 stations; 4 miles	X.25
DAVONG SYSTEMS INC.					
MultiLink	baseband	token-passing	2.5M	255 stations; 22,000 feet	
DIGITAL MICROSYSTEMS INC.					
HiNet	baseband	proprietary	500K	unlimited stations; 7,000 feet	IBM BSC, Sperry Univac Uniscope
EQUINOX SYSTEMS					
Equinox Data PBX	twisted-pair	TDM	9.6K	1,320 stations; 2 miles	
EXCELAN INC.					
Ethernet	baseband	CSMA/CD, IEEE 802.3	10M	1,024 stations; 500m	
GANDALF DATA INC.					
PACXNET	twisted-pair	proprietary	19.2K	2,048 stations; unlimited	IBM 3270 SNA/BSC, X.25 auto- dialers, PBX, TI multiplexers
GATEWAY COMMUNICATIONS INC.					
G/NET	baseband	CSMA/CD, CSMA/CA	1.43M	255 stations; 7,000 feet	X.25, SNA, BSC
IDE ASSOCIATES INC.					
IDEAnet	baseband	CSMA/CD	800K	20 stations; 2,000 feet	
INTECOM INC.					
LANmark Ethernet	baseband, twisted- pair, fiberoptic	CSMA/CD, IEEE 802.3	1M	8,192 stations; 54,000 feet	X.25, IBM 3270 InteNet Packet Controller (IPC)

TABLE 3

NETWORK INTERFACE HARDWARE

Network interface model name	Interface product type	Computers supported	Ports	Buffer memory size (bytes)	Networking software	Price (\$)
Interlan Ethernet/802.3 Communications Controller	board	Data General MV, Eclipse computers		16K	Xodiac	
802.3 LAN Micro Controller	board	Desktop Generation 10SP, 20, 30; S/20, C/30, CS/100B		32K	Xodiac	
MCA	board	Data General MV, Eclipse computers			Xodiac	
NBS	board	Data General MV, Eclipse computers				
COM 9026	board	Data Point 1560, 3200, 8400, 8600, 8800; VISTA-PC; IBM PC/XT/AT	2 asynch	2K	included	
Network Multifunction	board	IBM PC/XT/AT, Compaq, AT&T 6300	none	2K-512K	included	1,700
DMS-3/B	board	any standard terminal or microcomputer with a console monitor and RS232C port	3 asynch, 1 parallel, 1 RS422	64K	opt. HiNet software (\$1,500)	1,195
DMS-86	board	any standard terminal or microcomputer with a console monitor and RS232C port	3 asynch, 1 parallel, 1 RS422	256K-1M	opt. HiNet software (\$1,500)	1,995-3,995
HiNet PC/Adapter Card	board	IBM PC/XT/AT, Compaq, Eagle, NCR PC, Olivetti M24, TeleVideo PC, Zenith	1 asynch, 1 RS422	64K	opt. HiNet software (\$1,500)	495
DSS-1	box	all standard asynch computers	1,320 asynch	none	none	10,600-127,700
EXOS 101	board	computers with Multibus		64K-128K	opt. EXOS 8010 TCP/IP protocol package (\$10,000)	
EXOS 200 Series	board	computers with Multibus, Unibus, VMEbus, Q-bus		128K-256K	opt. EXOS 8010 TCP/IP protocol package (\$10,000)	2,100-3,820
PACX 1000	box	computers with RS232C, current loop, mil 188C, and RS449 port	1,024 asynch, 1,024 synch	none	included	10,000-270,000
PACX 2000	box	computers with RS232C, current loop, mil 188C, and RS449 port	896 asynch, 896 synch	none	included	11,000-290,000
PACX IV/IV SE	box	computers with RS232C, current loop, mil 188C, and RS449 port	1,024 asynch, 1,024 synch	none	included	10,000-270,000
PC-LNIM	board	IBM PC/XT/AT, Corona, Columbia, Compaq, Eagle, Sperry		none	opt. Netware G software (\$1,495), electronic mail (\$295)	2,495-137,898
NPR-001	board	IBM PC/XT/Portable		none	included	870-9,895
S/10	box		2,048 asynch, 2,048 synch	64K-2M	opt. LANmark software (\$10,000)	

LOCAL AREA NETWORKS
TABLE 3

LOCAL AREA NETWORK

Company Network name	Networking media	Network access	Data rate (bps)	Max. no. stations max. distance (end to end)	Gateways available
INTERLAN INC.					
NET/PLUS	baseband	CSMA/CD, IEEE 802.3	10M	1,024 stations; 2.5 km	
INTERTEC DATA SYSTEMS CORP.					
Data Networking System	baseband	polling, proprietary	3M	255 stations; 3,000 feet	
MAGNOLIA MICROSYSTEMS INC.					
MAGnet	baseband, twisted pair	token-passing	500K	64 stations; 2,000 feet	
METAPATH INC.					
ROBIN	baseband	proprietary, ATDM	2M	225 stations; 1.5 km	SNA/SDLC, Robin, X.25
NATIONAL INSTRUMENTS					
Net 488	baseband	token-passing	4M	15 stations; 2 km	

TABLE 3

NETWORK INTERFACE HARDWARE

Network interface model name	Interface product type	Computers supported	Ports	Buffer memory size (bytes)	Networking software	Price (\$)
S/40	box		4,096 asynch, 4,096 synch	64K-2M	opt. LANmark software (\$10,000)	
S/80	box	Ethernet-compatible computers	8,192 asynch, 8,192 synch	64K-2M	opt. LANmark software (\$10,000)	
NI1010A Unibus Ethernet Communications Controller	board	DEC Unibus VAX-11, PDP-11	none	15K	opt. NS4230 ITP/VMS software (\$2,500)	3,190
NI2010A Q-bus Ethernet Communications Controller	board	DEC LSI-11, Q-bus PDP-11	none	15K	opt. NS4210 ITP/RSX software (\$2,500)	2,290
NI3210 Multibus Ethernet Communications Controller	board	Multibus-based 68000, 8086, 28000 processors	none	15K	NS4244 ITP/UNIX System V software (\$2,500)	1,290
NI4010A Data General Ethernet Communications Controller	board	Data General Nova, Eclipse, Eclipse/MV	none	15K		2,490
NI5010 IBM PC Ethernet Communications Controller	board	IBM PC/XT, Compaq Personal Computer	none	4K	opt. NS4290 ITP/MS-DOS software (\$500)	575-775
NP100 Unibus Ethernet Protocol Processor	board	DEC Unibus VAX-11, PDP-11	none	128K-256K		3,790-4,290
NP200 Q-bus Ethernet Protocol Processor	board	DEC Q-bus system	none	128K-256K		2,190-2,690
NP300 Multibus Ethernet Protocol Processor	board	Multibus-based 68000, 8086, 28000 processors	none	128K-256K		2,190-2,690
NTS510 Network Terminal Server	box	computers with asynch RS232C port	8 asynch	none	included	3,200
INTS/VMS Integrated Network Terminal Server	board	DEC VAX	32 asynch	none		6,190
Data Storage System 20	box	HeadStart 128, 512, 1000			LAN-DOS utilities	2,495
Data Storage System 50	box	HeadStart 128, 512, 1000			LAN-DOS utilities	6,995
XM-422-96	board	Zenith Z100, IEEE 696	none	64K	opt. DR/NET software (\$250)	695
XM-422-EMZ80	box	Altos, Xerox, Epson	none	64K	opt. CP/NET software (\$250)	895
XM-422-PC	board	IBM, Corona, Zenith, PC compatibles	none	64K	opt. DR/NET software (\$250)	695
XM-422-TS	box		1 asynch	64K-256K	opt. CP/NET software (\$250)	895-1,295
XM-422-Z89	board	Zenith Z89, Z90	none	64K	opt. CP/NET software (\$250)	695
CPS-080		DEC VAX, most computers with RS232C ASCII port	64 asynch, 64 synch, 16 parallel	256K	opt. CROSSTALK, Blast, Move-it, Micnet, VVCP, Kermet software	
DPS 005	box	DEC VAX, most computers with RS232C ASCII port	4 asynch, 4 synch, 1 parallel	16K	opt. CROSSTALK, Blast, Move-it, Micnet, VVCP, Kermet software	375 (port)
DPS 020	box	most computers with RS232C ASCII port	16 asynch, 16 synch, 4 parallel	64K	opt. CROSSTALK, Blast, Move-it, Micnet, VVCP, Kermet software	
	board	Apollo, Sun, NCR Tower, VME, IBM PC and compatibles, DEC VAX, PDP-11, LSI-11	15 IEEE 488	none		2,000

TABLE 3
LOCAL AREA NETWORKS

Now for \$799, a VT-220 with perfect function,

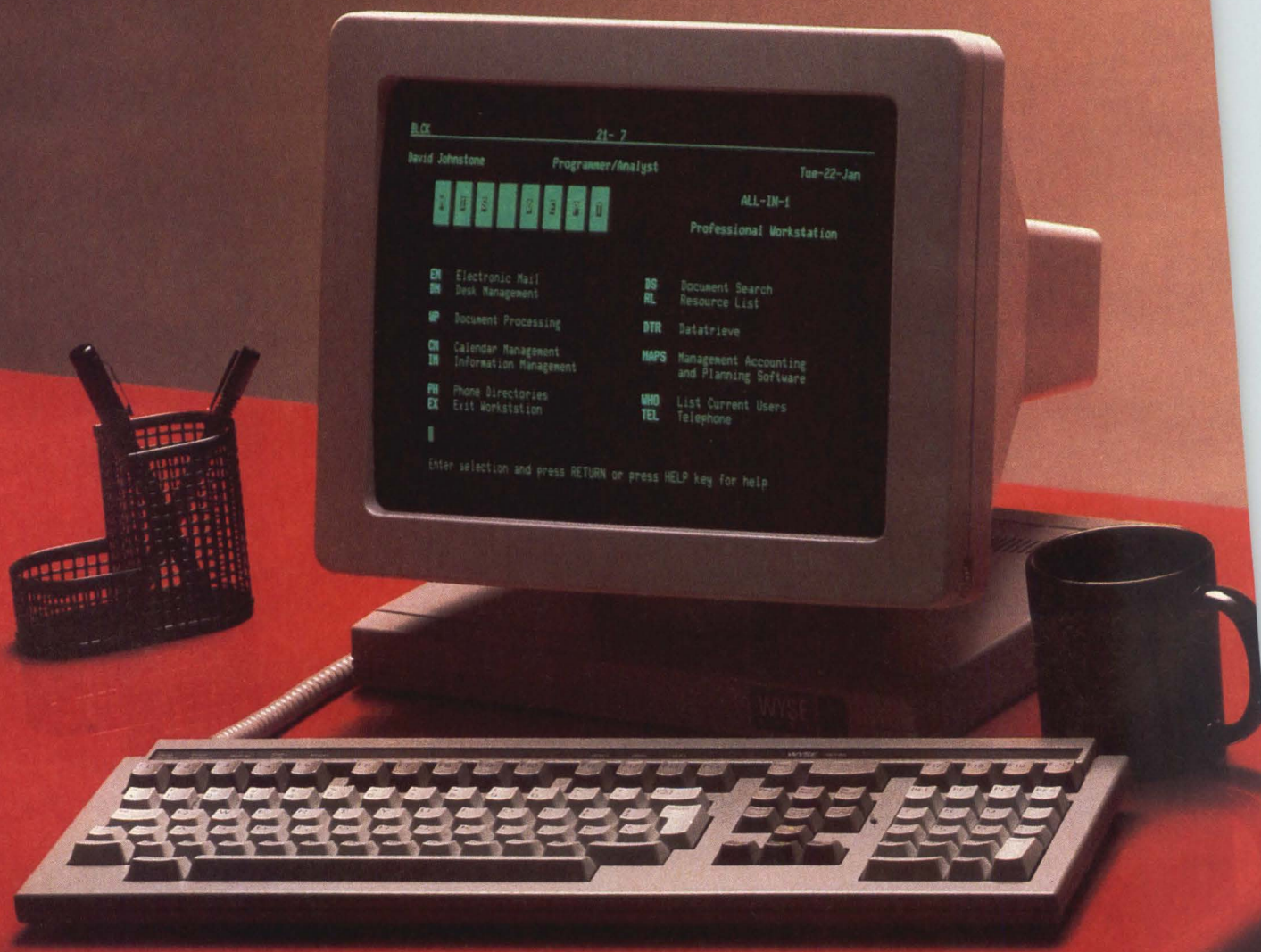

compatible terminal fit and form.

Our WY-85 gives you complete DEC VT-220™ software compatibility in function and fit, plus a form that beats all, for a price that beats all.

Like all our terminals, the WY-85 packs all the ergonomic features you want into an unusually small footprint. The generous 14" non-glare screen tilts, swivels, and handles a full 132-column format. Even the sculpted, low-profile keyboard adjusts for perfect fit and easier function.

So you get not just emulation, but the full operational compatibility you're looking for, including keyboard layout. For a lot less money, in a lot less space, with a lot more style.

No wonder Wyse terminals are now on more than 150,000 desktops worldwide.

For more information about our full line of computer display products, call the regional office nearest you.

WYSE

Regional Offices:

Northeast (201) 725-5054

Southeast (305) 862-2221

Midwest (313) 471-1565

Southwest (818) 340-2013

Northwest (408) 559-5911

LOCAL AREA NETWORK

Company Network name	Networking media	Network access	Data rate (bps)	Max. no. stations max. distance (end to end)	Gateways available
NEC INFORMATION SYSTEMS INC.					
BRANCH 4670	twisted-pair	CSMA	1M	64 stations; 1.2km	
NESTAR SYSTEMS INC.					
PLAN Series	baseband, broad- band, twisted-pair, fiber-optic	token-passing	2.5M	255 stations; 22,000 feet	bisynch, asynch, SNA
NORTHERN TELECOM INC./DATA SYSTEMS DIV.					
Omnilink	baseband	proprietary	56K	8 stations; 40,000 feet	none
NORTHERN TELECOM INC.					
SL-1/SL-100 Digital PBX	twisted-pair		up to 56K	30,000 stations 40 miles	X.25, IBM 3270 System 34/36/38, computer to PBX interface, Digital Trunk Interface
NOVELL INC.					
NetWare	baseband, broad- band, twin-ax, twisted- pair, fiberoptic	CSMA/CD, CSMA/CA, token- passing, proprietary	500K- 10M	24 to unlimited stations; unlimited	SNA, X.25, bisynch
ORCHID TECHNOLOGY					
PCnet	baseband	CSMA/CD	1M	255 stations; 7,000 feet	
PRIME COMPUTER INC.					
PRIMENET/RINGNET	twin-ax, fiber-optic	token-passing	10M	128 stations; 3,280 feet	bisynch, SNA, X.25
PROTEON INC.					
ProNET	baseband, twin-ax, twisted-pair, fiber-optic	token-passing, IEEE 802.5	10M	255 stations; 50km	

TABLE 3

NETWORK INTERFACE HARDWARE

Network interface model name	Interface product type	Computers supported	Ports	Buffer memory size (bytes)	Networking software	Price (\$)
APC III	board	APC 3	3 asynch, 3 synch, 1-2 parallel	64K	Corvus OMNINET software	
ASTRA 300 Series	board	ASTRA 330-300, ASTRA 350-300, ASTRA 370-300	32 asynch, 32 synch, 3-25 parallel	64K	opt. ITOS-NET	
Apple II	board	IBM PC; Apple II, III	6 asynch, 6 parallel	8K	Apple DOS, CP/M, any software run on IBM PC/XT or compatibles	595
Apple III	board	IBM PC; Apple II, III	6 asynch	8K	SOS, CP/M, any software run on IBM PC/XT or compatibles	595
IBM PC family	board	IBM PC; Apple II, III	1 parallel, 2 serial	8K	any software run on an IBM PC/XT or compatible	
4575	board	Northern Telecom 445, 405, 435, 565, 685	1-14 asynch, 2 synch, parallel (varies)	none	included (up to \$400)	1,200-1,600
SL-1 PBX	box and board	most ASCII asynch compatibles, variety of synch compatibles	3,000 asynch, 3,000 synch		proprietary	600-1,100
SL-100 PBX	box and board	most ASCII asynch compatibles, variety of synch compatibles	30,000 asynch 30,000 synch		proprietary	600-1,100
NetWare/ARCNET	box	IBM compatibles	2-5 asynch, 1-3 synch 1-2 parallel	256K-2M		6,900
NetWare/G-Net	box	IBM compatibles	1-2 parallel	256K-2M		6,900
NetWare/Omninet	box	IBM compatibles	2-5 asynch, 1-3 synch, 1-2 parallel	256K-2M		6,900
proprietary (S)	board	IBM compatibles, Victor 9000, Texas Instruments, DEC Rainbow	5 asynch	500K-2M		12,295
	board	IBM compatibles	2-5 asynch, 1-3 synch, 1-2 parallel	256K-2M		6,900
PCnet BLOSSOM	board	IBM and compatibles	none	384K	included; opt. PCnet Cluster Kit (\$100)	795-1,295
PCnet PLUS RAM	board	IBM and compatibles	none	256K	included; opt. PCnet Cluster Kit (\$100)	595-975
PCnet Rev D	board	IBM and compatibles	none	none	included; opt. PCnet Cluster Kit (\$100)	495
PRIMENET Node Controller	board	Prime 50 series systems	none		opt. Primenet software (\$7,500), File Transfer Service (\$2,000)	5,000
P1000	board	DEC VAX, PDP-11		2K	opt. TCP/IP, Ringway software	3,150-1.5m
P1100	board	DEC LSI-11, PDP-11		2K	opt. TCP/IP software	3,150-1.5m
P1200	board	all Multibus computers		2K	opt. TCP/IP software	3,150-1.5m
P1300	board	Columbia, Compaq, Eagle, IBM PC/XT/AT, AT&T 6300		2K	opt. NetWare/P, TCP/IP software	795-200,000
P1400	board	Gould, Perkin-Elmer, Texas Instruments 9900		8K		2,700-1.5m
P4000	box	Data General, IBM, Prime, Wang	16 asynch	4K		8,000-1.5m

LOCAL AREA NETWORKS
TABLE 3

LOCAL AREA NETWORK

Company Network name	Networking media	Network access	Data rate (bps)	Max. no. stations max. distance (end to end)	Gateways available
RACAL-MILGO INC.					
Planet	baseband	token-passing, proprietary	9.216M	500 stations; 13 miles	RS232C interface
SANTA CLARA SYSTEMS INC.					
PCnet	baseband	CSMA/CD	1M	50 stations; 6,000 feet	ARCNET, Omninet, Starnet
SIECOR FIBERLAN					
Net 10	baseband, fiber-optic	CSMA/CD, IEEE 802.3	10M	1,024 stations; 2.5km	Ethernet Version 1.0, 2.0
SYTEK					
LocalNet 20	broadband	CSMA/CD	120K	35 miles	
TANGENT TECHNOLOGIES LTD.					
ThinkLink	twisted-pair	proprietary	1M	24 stations; 3,000 feet	IBM 3270, X.25, Ethernet
TEXAS INSTRUMENTS INC.					
Ethernet	baseband	CSMA/CD	10M	1,024 stations; 2,500m	X.25; Bridge Communications GS/1, GS/3; Texas Instruments Business System
UNGERMANN-BASS INC.					
Net/One	baseband, thin coaxial baseband	CSMA/CD	10M	1,024 stations; 2,800m	X.25
Net/One	broadband	CMSA/CD	5M	1,500 stations; 10 miles	X.25
VLSI NETWORKS INC.					
1553-NET	baseband	CSMA/CD, CSMA/CA	3M	255 stations; 8,000 feet	
WANG LABORATORIES, INC.					
WangNet	broadband	CSMA/CD, IEEE 802.3, token-passing, proprietary	up to 10M		

TABLE 3

NETWORK INTERFACE HARDWARE

Network interface model name	Interface product type	Computers supported	Ports	Buffer memory size (bytes)	Networking software	Price (\$)
PL 2000 TAP	box	all computers with RS232C port	2 asynch, 2 synch	none	none	1,200-1,600
PL 2003 TAP Card	board	all computers with RS232C port	4 asynch, 4 synch	none	none	1,400-1,800
PCnet	board	IBM, AT&T, Compaq, Tele-Video, Corona, Columbia	3 parallel	none	included	495-2,095
PCterminal		IBM, AT&T, Compaq, Tele-Video, Corona, Columbia	2 asynch, 4 IEEE 488, 3 parallel	64K-640K	software (\$1,495)	1,595-2,195
Interface hardware from Bridge Communications		DEC, Xerox, Ungermann-Bass				
20/100	box		2 asynch			350-500 (per user)
20/105	box		2 synch			350-500 (per user)
20/220	board					350-500 (per user)
801	box	IBM PC and compatibles	8 asynch, 24 synch, 2 parallel	512K-16M	TNOS software	15,000-235,000
EI300	board	Texas Instruments Business System 300	3 asynch	128K	opt. Distributed Network I/O (DNIO)	2,950
EI990	board	Texas Instruments Business System 600, 800		128K	opt. Distributed Network I/O (DNIO)	2,950
Ether-Link	board	IBM PC/XT, Texas Instruments Professional Computer, Portable Professional Computer	none	2K	opt. 3M Ether-Series (\$500)	585-899
Network Interface Unit 2A	box	any computer with RS232C, IEEE 488 port	24 asynch, 20 synch		opt. Net/One, Virtual Circuit, Datagram software	11,525
Network Interface Unit 130	box	any computer with RS232C, IEEE 488 port	2 asynch, 2 synch		opt. Net/One, Virtual Circuit, Datagram software	1,400
Network Interface Unit 150	box	any computer with RS232C, IEEE 488 port	6 asynch, 4 synch		opt. Net/One, Virtual Circuit, Datagram software	2,900
Personal Network Interface Unit 1	board	IBM PC and compatibles			opt. DiskShare, PrintShare, MailShare software	1,095
Personal Network Interface Controller	board	IBM PC and compatibles		16K	opt. DiskShare, PrintShare, MailShare software	595
1553-A	board	Apple II, Ile				349 (board)
1553-I	board	IBM PC/XT/Portable and most compatibles	4K-64K		PC-LAN software (\$250 per network)	349 (board)
1553-S	board	Zenith Z-100				349 (board)
CMUX-3270						
Ergo-II WN2, Ergo-III WN3						
FFM66449, FFM96232						
PC-PM075						
Netmux						
Cable Interface Unit (CIU)						

LOCAL AREA NETWORKS
TABLE 3

LOCAL AREA NETWORK

Company Network name	Networking media	Network access	Data rate (bps)	Max. no. stations max. distance (end to end)	Gateways available
WESTERN TELEMATIC INC.					
RS232C Smart Switch	twisted-pair		9600K	16 stations; 2,000 feet	ASCII, RS232C port
XYPLEX INC.					
XYPLEX System	broadband, fiberoptic	CSMA/CA	1M	32,000 stations; 6 miles	XP-3270 SNA, bisynch
ZTEL INC.					
Private Network Exchange (PNX)	baseband, twisted-pair, fiberoptic	token-passing, IEEE 802.5	4M	250 stations; 64 km	

Information was solicited but not received from the following manufacturers:

Cadmus Computer Systems	Hewlett-Packard Co.
David Systems	Honeywell Information Systems
Digital Equipment Corp.	

For information on their products, consult the Supplementary Directory of Manufacturers on page 113.

Your low-cost direct line to the value-added market

Mini-Micro Systems DIRECT RESPONSE CARDS

- Sell products and services directly
- Introduce new products
- Distribute catalogs and literature
- Investigate new applications
- Develop quality sales leads

1985 Postcard Schedule

Materials Closing Date:	2/1	4/5	8/1	10/1
Mailing Date:	March	May	Sept.	Nov.

Format

Loose Card Deck
 Card Size — 3 1/2" x 5 1/2"
 Live Copy — 3 1/8" x 5 1/8"

Mechanical Requirements

Negatives — right reading emulsion side down
 Camera ready mechanicals — 110 line screen

Rates*

	Advertisers	Non-advertisers
1 card	\$1400	\$1650
2 cards	1340	1585
4 cards	1250	1485
6 cards	1175	1400
2 color	\$120	4 color \$400

Contact:

Carol Anderson, Sales Manager
Mini-Micro Systems
Direct Response Cards
 221 Columbus Avenue, Boston, MA 02116
 (617) 536-7780

* Combined frequency applies for Mini-Micro Systems, Business Computer Systems and PC Products Direct Response Cards

TABLE 3

NETWORK INTERFACE HARDWARE

Network interface model name	Interface product type	Computers supported	Ports	Buffer memory size (bytes)	Networking software	Price (\$)
SS-8	box	any CPU with RS232C ASCII port	8 asynch	none		895
SS-16	box	any CPU with RS232C ASCII port	16 asynch	1K per port		1,600
XP-CC8	box	computers with RS232C asynch port	8 asynch			5,000
XP-IPC	board	IBM PC	1 asynch			960
XP-UN64	board	DEC VAX	64 asynch			5,700-9,500
Data Adapter	board	all computers compatible with RS232C port	1 asynch, 1 synch		included	
Data Server	box	all computers compatible with RS232C port	1 asynch, 1 synch		included	
Ztel Processing Element		all computers compatible with RS232C port		up to 16M	included	

LOCAL AREA NETWORKS
TABLE 3

Wondering
Where
To Turn
Next?

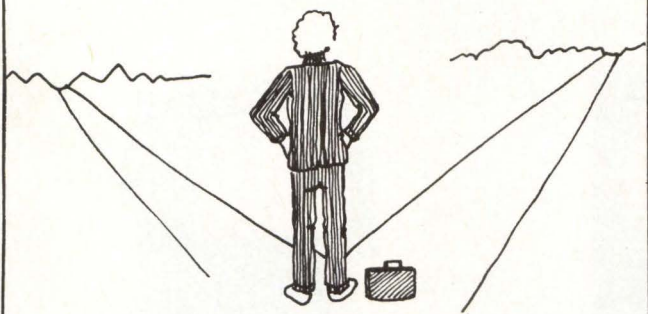

Turn To
Mini-MicroSystems

**Career
Opportunities
Section**

CIRCLE NO. 35 ON INQUIRY CARD

**Compatibility
Problems?**

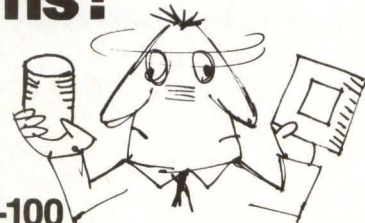

Solve them
with the PCT-100
**Programmable Communications
Translator**

The PCT-100 is an in-line, user-programmable RS-232 protocol and data translator. It can provide a simple, inexpensive solution to your communications and compatibility problems.



- Terminal & Printer Emulation
- Baud Rate Conversion (50 through 19.2 kbaud)
- Handshake Translations (XON/XOFF, CTS/RTS, ENQ/ACK)
- Code Conversions (ASCII, Modified ASCII, EBCDIC)
- Bidirectional Manipulation of Data Strings, Bytes, Bits
- User-Programmable
- User Programs are Easily Implemented
- Built-in Compiler, Editor and Debugger
- Programs via any RS-232 ASCII Device
- Only \$495 (single unit quantities)
- User's Technical Manual \$25



Method Systems Incorporated

3511 Lost Nation Road
Willoughby, Ohio 44094
(216) 942-2100

CIRCLE NO. 36 ON INQUIRY CARD

18 Reasons We're Uniquely



1 There's our position on the bottom line. Simply put: No one can match our emulations, editing and ergonomics for \$549. Can anyone better this price?



2 Only at the expense of features. Often it's obvious where they've cut corners: With a pug-ugly box. But as you can see, the Ampex 210 is sleekly ergonomic.



3 We human-engineered the Ampex 210 with a full 14" screen that tilts and swivels to just the angle you need. So it's comfortable to use, no matter how you're positioned.



7 As well as the local editing and block mode transfer capacities you need to speed work flow.



8 Plus 16 resident emulations you can switch at the touch of a key. Including the TeleVideo 910, 910+, 912, 920 or 925*..



9 The Lear Siegler ADM 3, ADM 3A, 3A+ or ADM 5*..



13 What's more, we'll add more. In OEM quantities, we'll customize our 210's appearance, personality and programming so it's perfectly suited to your needs.



14 And if you need a more powerful terminal with even more features, consider the next step up in our family of terminals: the Ampex 230.



15 We back every Ampex terminal with a six month warranty and a worldwide service network.

Positioned to Meet Your Needs.



4 We also equipped it with a low-profile, Selectric-style, adjustable-slope keyboard for easy typing.



5 And with a soothing, flicker-free amber screen for easy reading. (If you prefer, you can have the option of green at no extra cost.)



6 But ergonomics are just the beginning. The Ampex 210 is as beautifully engineered inside as outside. With line graphics and a bidirectional printer port as standard features.

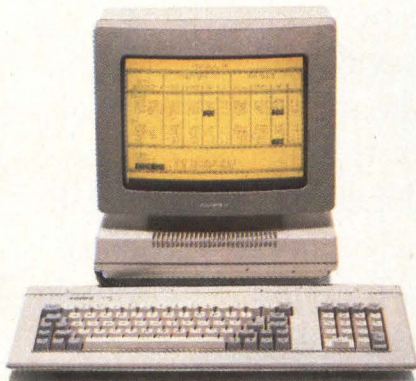

10 The Esprit (Hazeltine) 1400, 1410 or 1500*..



11 ADDS Regent 20, 25 and Viewpoint*..



12 And Qume's QVT 102*..



16 How can we pack all that into the Ampex 210 for just \$549? We're in a position to be competitive. We can take advantage of over 25 years of video, computer peripheral and offshore manufacturing experience.



17 So if you need a well-designed, full-featured terminal, call us at 800 621-0292. Or 800 821-9473 in California. We'll show you how you can be very comfortably situated for just \$549.

AMPEX

18 The Ampex 210 is from the Computer Products Division of Ampex Corporation. One of The Signal Companies 

Never Again Choose Between Price and Quality.

The competition says you must sacrifice one for the other. What they're really saying is they can't give you both. Introducing the TeleVideo® 921. Proof that low price and high quality do go together.

But don't let its low price fool you. The 921 is years ahead with features taken from our most expensive terminals. Like selectable embedded or non-embedded field attributes. 32 nonvolatile function keys. 6 fast edit keys. And something we're famous for: in depth support. Including technical assistance, service training and award winning documentation.

One glance at its nonglare amber or green screen with true tilt and swivel. One pass over its low profile, sculptured keyboard. And you know this terminal is built right. In fact, the 921 is built to the highest quality standards in the industry — our own. We use modular subassemblies. All components are pretested and prestressed. Boards are mounted vertically to run cooler, last longer. There's even room to plug in upgrade options. Like our low cost, Tektronix® compatible graphics board.

The point is this. Don't sacrifice either price or quality. Get both. Get the new TeleVideo 921.

Call toll free, (800)
538-8725. In California,
call (408) 745-7760.

Regional Sales Offices: California/Santa Ana (714) 476-0244, California/Sunnyvale (408) 745-7760, Georgia/Atlanta (404) 447-1231, Illinois/Chicago (312) 397-5400, Massachusetts/Boston (617) 890-3282, New York/New York (516) 496-4777, Texas/Dallas (214) 258-6776

The TeleVideo 921



Terminals
TeleVideo Systems, Inc.

Tektronix is a registered trademark of Tektronix, Inc.

CIRCLE NO. 37 ON INQUIRY CARD

THE SEARCH IS ON FOR STANDARDS, SECURITY

Networking software is matching hardware to hardware while opening up application opportunities for value-added resellers and system integrators

Carl Warren, Western Editor

Software is rushing to the rescue of networks. The purpose of a network is to provide terminals with mutual access to many devices and to share data among them. What makes a network operational is software, and newer, sophisticated approaches are rapidly becoming available.

Independent software consultant Robert Anton Byers explains, "Computers are primarily useful for handling large databases. The network extends the availability of the database; the trick is to maximize the network's use." And according to Robert G. Brown, general manager for communications products of Quadram Corp., Norcross, Ga., the growing interest in networks stems from "increasing productivity, by making the best use of [those] databases."

Leo Nikora, group manager of systems product marketing, Microsoft Corp., Bellevue, Wash., says networking software must provide:

- A standard interface for applications which makes the networking hardware transparent to the software developer and end user
- File security, both from a restricted-use standpoint and to prevent accidental corruption due to a number of users accessing the same file.

Brown says of hardware transparency: "Application developers want to develop to a standard interface and not worry what's below it. In most cases, they don't understand the full system architecture needs anyhow, and they shouldn't be worried about it."

Nikora says there will be many networks that offer a range of cost-performance attributes for

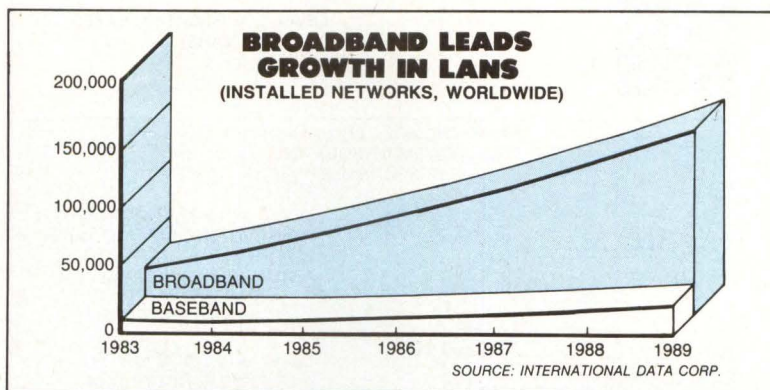

NETWORKING SOFTWARE

specific applications and environments. "No single network scheme will meet everyone's requirements. Special interfaces and distribution methods will be used...the requirement is to create a standard interface that allows software developers to develop generic networking software that can be transported across ranges of networks, independent of the physical hardware layer."

Local area networks (LANs) have been stuck in the hardware, physical layer of the International Standards Organization (ISO) model. Network designers were enamored of the technical aspects of sending information over a wire, not of the actual application of the network. Network watchers like Sherry Geddes, vice president, communication systems for Strategic Inc., Cupertino, Calif., says this fixation on technology for technology's sake hindered the growth of networks. "That isn't the case now. Forget the

hardware. The card will take care of the wire. The software guy can worry about applications and forget the guts of the network.”

Many manufacturers of networking software are coming up with “standard” interfaces. Among these are Novell Inc., with its Netware software; Applied Intelligence Inc., with PC-NOS, and Network Research Corp., with Fusion. The Fusion network software works with a number of LANs and operating systems including MS-DOS, UNIX and Digital Equipment Corp.’s VMS. Digital Research Inc. (DRI) has developed a standard Concurrent PC-DOS interface.

Although there may be no true standard interface, most companies planning on implementing networks are excited about the prospect of having device-independent application software.

Nissan Motor Corp. is developing a shared-resource network based on IBM Corp. PCs. According to a company spokesman, one of the inhibiting factors has been the lack of a consistent way to create applications. Nissan wants to create a series of applications that would be transportable across a range of networks, and they are looking forward to having a common interface from which to work.

File security is important

The use of a network implies a multiuser system and file sharing and therefore the necessity for file security. One difficulty facing software developers is the need to cobble their own methods of file locking and file sharing. “Everyone had their own way of doing things, and that resulted in confusion,” says Jean Yates, chairwoman of marketing research firm Yates Ventures, Palo Alto, Calif. Hardware vendors such as AST Research Inc., Corvus Systems Inc. and Western Digital Corp. agree that having a single, common approach to solving interface and file-security problems is an important step forward for networks.

Virtually all vendors of network hardware and software agree that very few applications are network-oriented. In most cases, applications are input/output bound—they sit and wait for data input from somewhere, usually a keyboard. This represents a bottleneck because data has to be put into the applications manually, typically moving the data from a remote storage device to the local desktop computer. Flags are set to advise other members of the network that the file is in use and can’t be updated until released.

Open system a must

Ian Wallace, director of product support for Applied Computer Techniques (ACT) Plc., Birmingham, England, contends that having an open software architecture is a must for networking systems. “We are using the Corvus Omninet chipset on a board of our design as the physical layer of our network. We could have used anything since it has to be transparent. What we wanted, and got, was a transportable operating network system from Microsoft with Networks 1.0. It gave us the level of integration we wanted and makes it easy for our value-added resellers (VARs) to add value to our Point 32 system with specialized network applications.”

The Microsoft Networks 1.0 is an extension of Microsoft’s operating system MS-DOS. The software permits multiple microcomputer systems to share resources. Currently 26 vendors of networking systems, including IBM, have implemented Networks. Some industry observers are

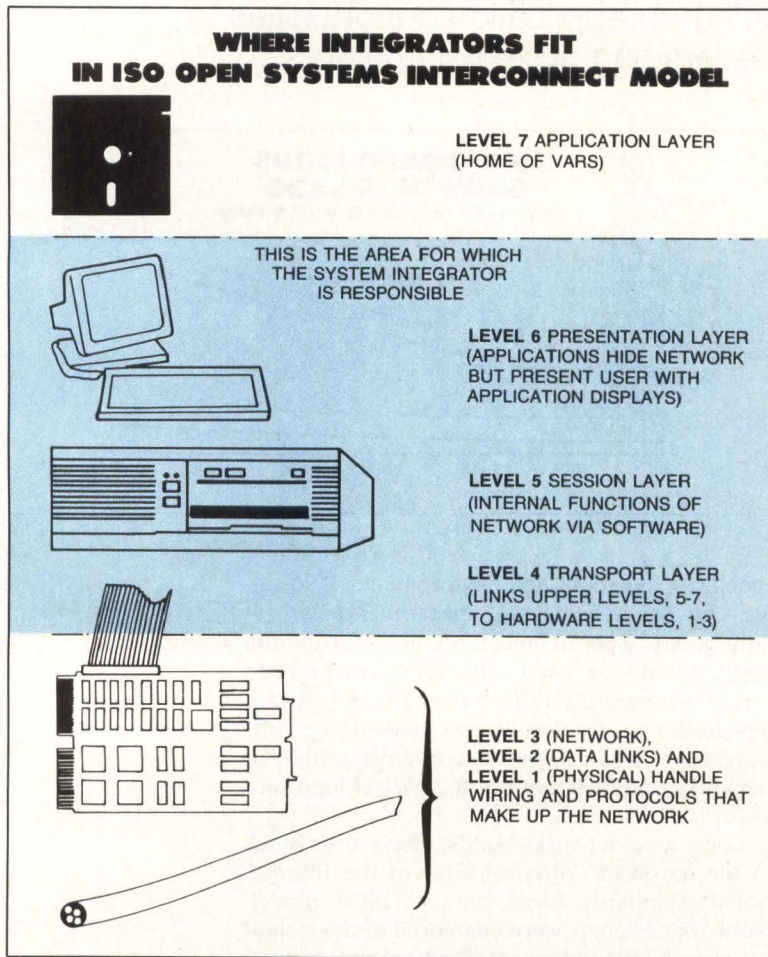

Networking software has moved up the International Standards Organization model to cover the fourth through the seventh layers. Because of that, application developers can concentrate on the operation of the software rather than on the guts of the network. Industry consultants agree that the application layer will push the acceptance of networks.

Managing the data on a network

With local area networks (LANs) appearing to provide sharing of resources such as disk storage, system integrators face a new problem: how to find the data.

Many of the systems now available, such as Applied Computer Techniques' Apricot Point 32, can support multiple file servers. What's needed in such systems is a conscious effort to manage the data store. Microsoft Corp.'s Leo Nikora says that what is at issue is not technology but rather deciding how to line up the data.

Since most networking software provides some form of device-naming convention (Microsoft's MS-DOS uses full English names), each file server can be given a specific name. For example, the file server where word-processing documents will be stored would be called "Document," the one for spreadsheet data, "Financial," and so on. One method of finding a specific piece of data would be asking for a directory of each file server.

Another approach would use a standard device name. Under that approach, /DOCUMENT/THANKYOU.LTR, would retrieve the "Thankyou.ltr" file from the file server designated "Document." The slashes (/) denote typical

network convention under MS-DOS or UNIX to define a specific path.

Because most of the newer operating systems, such as IBM Corp.'s PC-DOS and MS-DOS, provide UNIX-like sub-directories in a tree structure under parent directories, the file management problem can become more difficult. But an approach similar to one used to locate a flat file can be executed to find files in hierarchy-based operating systems like PC-DOS or UNIX.

/DOCUMENT/LETTER/SPECIAL/THANKYOU.LTR, would first find the file server called "Document," then the parent directory "Letter," the sub-directory "Special" and finally the specific file "Thankyou.ltr." The system integrator must decide how to relate the sub-directories to the total system and how to develop a road map for the network users.

The next generation of networking software should provide a better solution to the problem. Network operating systems that automatically locate files by using virtual objects as pointers are expected by late this year. Thus, a user can find any file on any server in any network simply by asking for it.

betting that Microsoft, in concert with IBM, has established a de facto standard not only for the overall network operation but also for the integration interface.

The Networks concept is totally hardware-independent, but the software is dependent on MS-DOS 3.1. It provides the integration level at the ISO transport interface layer. Networks is designed to establish virtual circuits to the hardware network. Thus, reading, writing and error correction are taken care of without intervention on the part of the user or application software.

ACT's Apricot Point 32 system takes advantage of the networking software. The system permits as many as 10 file servers to reside on the system. "We can't limit the network, or the cleverness of the software developer. The open architecture means that software can be written that recognizes all the devices on the network and maximizes their usefulness," says Wallace.

Moving to a higher level

Removing the application programmer from the primitives of the hardware and operating system is clearly a benefit. This has been a much-sought-after goal by most system designers, as evidenced by the major industry trends toward standard software interfaces. But Microsoft's Nikora says that providing a common interface just moves the application developer to a higher level and doesn't inhibit his designs.

Strategic's Geddes says that the transport, session and presentation layers are the most

important levels of the ISO model. The move to the higher levels of the model are making it easier to handle file sharing and security problems. "That's going to have a strong impact on the viability of networks in general," says Geddes. Quadram's Brown agrees, but he isn't convinced that the VAR, user or software developer should be completely restricted from the basic operating system altogether. "We don't know exactly what someone will want to do. We shouldn't inhibit creativity. So we can't hide everything; just make it easier."

DRI's president and chief executive officer, John Rowley, says integrators require a consistent architecture, as well as portability of the application. "UNIX and UNIX-like operating system approaches appear to offer a viable solution. The key, however, isn't necessarily the actual operating system, but rather a consistent interface approach."

Nikora and Brown warn that licensing may be a problem. Typically, single-user application software is licensed to one machine. If it is put on a file server for use by many users, it can violate the license. To get around this, companies such as Ashton-Tate, and Probase Group, are offering network versions of their database products that provide the required license, as well as file lockouts and sharing semaphores. □

Interest Quotient (Circle One)
High 459 Medium 460 Low 461

NETWORKING SOFTWARE

TABLE 4

Company Package name	Network	Network hardware interface	Computer/operating system compatibility	Required additional software	Price (\$)	Function
APPLIED INFORMATION SYSTEMS INC.						
BURCOM	proprietary	DEC	DEC VAX/VMS, PRO/POS, MICRO/R SX, PDP-11/R SX		695 (PRO); 1,995 (MICRO); 4,400 (PDP-11); 5,000 (VAX)	allows communications between DEC and Burroughs computers, supports the Burroughs point-to-point conversational and poll-select protocols to give high throughput data transmission
BRIDGE COMMUNICATIONS INC.						
SW/1-A/BSC	Ethernet, XNS, asynch, bisynch support, Ethernet systems products	CS/1-A or CS/1-BSC Bridge Communications Server/1	independent operating systems		150 (per server)	provides multiplexed virtual circuits for 32 terminal devices connected with hosts across Ethernet; supports clearinghouse logical naming
SW/1-HSM	Ethernet, XNS, Ethernet systems products	CS/1-HSM	DEC VMS, Berkeley UNIX Version 4.2 supporting multiple DEC DMF32	operating systems supporting DEC DMF32	150 (per server)	provides multiplexed virtual circuits for up to 64 users in a DEC VAX system; supports clearinghouse logical naming
SW/1-SNA (3270)	Ethernet, XNS, SNA 3270, Ethernet systems products	CS/1-SNA (3270)	IBM MVS VTAM; NCP/ACF; supporting IBM 3274 Model 51-C	SNA network supporting IBM 3274 devices	1,000 (per server)	provides protocol conversion for ASCII (asynch) terminals to access IBM or compatible mainframes supporting SNA; emulates 3274 Model 51.C; allows TeleVideo 925, IBM 3101, ADM 1178, DEC VT100 terminals to perform as 3278 displays
SW/1-X.25	Ethernet, XNS X.25 host support, Ethernet systems products	CS/1-X.25 Bridge Communications Server/1	independent operating systems supporting X.25 interface	X.25 software on host, high speed hardware interface to 64Kbps	2,000 (per server)	provides multiplexed virtual circuits to hosts supporting X.25; local network appears to host as PDN
SW/2-CS/ICS	Ethernet, XNS, X.25, X.29, X.28, X.3, TYMNET, TELENET	GS/1			2,000	connects physically isolated Ethernet via X.25 network; supports 48 sessions
SW/3	Ethernet, XNS, HDLC	GS/3			300	performs internetwork routing for up to 8 remote Ethernets
SW/100-488	Ethernet, XNS, IEEE 488 support	CS/100-488	independent operating systems	IEEE 488 interface driver	150 (per server)	provides host or system connection service for IEEE 488 compatible devices; functions as an IEEE 488 controller
SW/100-A/BSC	Ethernet, XNS, asynch, bisynch support	CS/100-A or CS/100-BSC Bridge Communications Server 100	independent operating systems		150 (per server)	provides multiplexed virtual circuits for 32 terminal devices connected with hosts across Ethernet; supports clearinghouse logical naming
SW/100-NCS	Ethernet, XNS, asynch, bisynch support	NCS/100 with network of CS/1-A, CS/1-BSC, CS/100-A, CS/100-BSC, CS/1-AX, CS/1-BSCX, CS/100-AX, CS/100-BSCX	independent operating systems		1,500	a network control server which supports up to 40 CS/1 or CS/100 servers; provides centralized control and boot loading servers; maintains clearinghouse logical naming and configuration files on single unit
CINCOM SYSTEMS INC.						
NET/MASTER	SNA	IBM 43XX, 30XX; FACOM	IBM MVS, VS/1	IBM VTAM	15,000-75,000	integrates a multi-application IBM network into a single, integrated operating unit
CODEX CORP.						
Codex 4000 Series LAN	Net/One	Codex 4001, 4002 Entryway, PC Entryway	IBM PC, MS-DOS	Codex Personal Computer Network, Network Operating Systems Software (NOSS)		allows sharing of disks and printers on the LAN
COMMUNICATION MACHINERY CORP.						
TCP-IP	Ethernet	Communication Machinery Corp. ENP-10, ENP-20, ENP-30, ENP-40	UNIX, DEC VAX/VMS		400	implements TCP-IP protocols with ARPANET FTP, SMTP; TELENET; Berkeley UNIX Version 4.2, RCP, RSH, RLOGIN

NETWORKING SOFTWARE

TABLE 4

Company Package name	Network	Network hardware interface	Computer/operating system compatibility	Required additional software	Price (\$)	Function
XNS	Ethernet	Communication Machinery Corp. ENP-10, ENP-20, ENP-30, ENP-40	UNIX, DEC VAX/VMS, VERSAdos		500	implements XNS protocols
COMMUNICATIONS SOLUTIONS INC.						
Access/SNA	SNA	synch interface	MS-DOS, UNIX			emulates IBM full cluster controller products; written in C; off-the-shelf emulations for IBM 3270, 3770, 5251; bisynch 3270 available
CORVUS SYSTEMS INC.						
Constellation II	OMNINET	Corvus OmniDrive, Disk Server plus transporter cards	IBM PC-DOS 1.X, 2.X, 3.0; Apple DOS; CP/M Pascal; UCSD P-system; Pro-DOS; Texas Instruments; MS-DOS 1.1, 2.1	multicomputer applications software	150-495 (per operating system)	shared Corvus hard disk access and management; user/password access; diagnostics; configuration utilities
OmniShare	OMNINET	transporter cards	IBM PC-DOS 2.X, 3.0	multicomputer applications software	795-995 (includes interface transporter card for IBM XT/AT)	shared Corvus hard disk access and management; user/password access; diagnostics; configuration utilities
COSI						
Communique	proprietary	RS232C	IBM PC and compatibles, computers with UNIX	none	PC package (\$195), opt. UNIX package (\$295)	connects IBM PC running DOS with UNIX-based micro- and minicomputers; emulates DEC, IBM, Tektronix (graphics) terminals
DATA GENERAL CORP.						
Xodiac	Ethernet, IEEE 802.3, Net/One	Ethernet 802.3 Micro Controller, Interlan Communications Controller, Data General NBS, MCA	Data General AOS, AOS/VS	Data General Remote Infos Agent (RIA), Remote Database Agent (RDA)		provides virtual terminal; resource management applications, file transfer and electronic mail capabilities
DAVONG SYSTEMS INC.						
MultiLink	MultiLink	ARCNET	IBM PC-DOS 1.1, 2.0, 2.1, 3.0	LAN electronic mail		provides IBM PC users with the ability to share Davong hard disk drives; acts as file server to other PCs in network
DIGITAL MICROSYSTEMS INC.						
HiNet	proprietary HDLC, SDLC, Master/Slave polling	HiNet PC/Adapter Card; DMS-3/B or DMS-86 Network Interface; DMS-86 or DMS-5086 Network Workstation	MS-DOS; CP/M-86, HIDOS (proprietary)		1,500 (bundled with Master, includes MS-DOS); 2,000 (unbundled); 500 (additional for MS-DOS); 500 (additional for CP/M-86)	provides hard disk storage utilities; 3 level password protection; fault tolerance; support for multiple operating systems
EXCELAN INC.						
EXOS 8010 TCP/IP Protocol Package	Ethernet, ARPANET	EXOS Ethernet front-end processors	UNIX using TCP/IP protocol package		10,000 (TCP-IP protocol module)	self-contained, single-board LAN subsystem addresses issues of high-level protocol software integration
GATEWAY COMMUNICATIONS INC.						
Netware/G	G/NET	Gateway Communications PC-LNIM	IBM PC, MS-DOS		1,495; 295 (electronic mail)	provides file server operating system; a complete set of tools for coordinating multiuser access to data
H&A COMPUTER SYSTEMS INC.						
PCAM	IBM PC Access Method Network	asynch modem, IBM Series/1 card	IBM EDX, PXS, PC-DOS		950	allows IBM PC to communicate with IBM Series/1; accesses and copies files to and from Series/1 and PC

NETWORKING SOFTWARE
TABLE 4

NETWORKING SOFTWARE

TABLE 4

Company Package name	Network	Network hardware interface	Computer/operating system compatibility	Required additional software	Price (\$)	Function
RSS	Remote IBM Series/1 Network	asynch, bisynch modem; IBM Series/1 card	IBM EDX, PXS		3,500	provides communication and networking of IBM Series/1 minicomputers; includes remote program execution, file access and copy, RS 3270 emulation
HONEYWELL INC.						
DPS6-DSA	proprietary (Distributed Processing System 6-Distributed System Architecture)	synch modem, modem by-pass	Honeywell MOD 400	host file transceiver	435-790 (license fee software); 55-1,040 (networking modules)	functions as a distributed information processor, a switch, an end-point or as an interface to a public or value-added network
DPS6-SNA	SNA	synch modem, modem by-pass	Honeywell MOD 400		160-290 (software annual license fee), 40-2,435 (networking modules)	supports communications between DPS 6/Level 6 and IBM SNA network; includes SNA transport, interactive terminal, remote job entry facilities
RNP/6	proprietary (Remote Network Processor/6)	synch modem, modem by-pass	Honeywell MOD 400	host file transceiver	165-300 (software license fee); 85-355 (networking modules)	offers networking facilities and transport mechanisms for linking various processors in a distributed environment; combines the functions of remote job entry, terminal concentration, file transmission, application-to-application communications; networking support tools
INNOVATEK MICROSYSTEMS INC.						
ComLINK	asynch	DEC DLV11, DL11	DEC PDP-11/RT-11, LSI-11/RT-11, PRO 300 Series/RT-11		775 [license (per site)]	remote communications enhancement software; provides speed and flexibility for serial line communications on DEC systems; enables systems to emulate an ASR terminal to a remote host computer
ComLINK-Plus	asynch	DEC DLV11, DL11	DEC PDP-11/RT-11, LSI-11/RT-11, PRO 300 Series/RT-11		1,255 [license (per site)]	remote communications enhancement software allows automated tasks to be developed by users; provides interactive commands and 20 special directives
INTELLIGENT TECHNOLOGIES INTERNATIONAL CORP.						
Exchange Series	SNA, bisynch, asynch network	asynch, bisynch, modem	IBM PC/XT/AT and compatibles, IBM PC-DOS	file exchange, coax exchange	695-1,395	supports data communication between IBM PC, PC and mainframe; capacity to share, transfer and file on-line information
INTERLAN INC.						
NP100 Unibus Ethernet	Interlan NET/PLUS, Ethernet		DEC VAX/VMS, Berkeley UNIX Version 4.2		4,290	provides on-board XNS/ITP or TCP/IP networking protocols which offload host from extensive CPU protocol processing
NP200 Q-bus Ethernet Protocol Processor	Interlan NET/PLUS, Ethernet		DEC RSX-11M/M+		2,690	provides on-board XNS/ITP networking protocols which offload host from extensive CPU protocol processing
NP300 Multibus Ethernet Protocol Processor	Interlan NET/PLUS, Ethernet		UNIX System V		2,690	provides on-board XNS/ITP or TCP/IP networking protocols which offload Multibus systems from extensive CPU processing
NS4210 ITP/RSX	Interlan NET/PLUS, Ethernet	Interlan NI1010A Unibus, NI2010A Q-bus Ethernet controller	DEC RSX-11M/MX	RSX-11M/M device driver, application software	2,500 (distribution kit); 25,000 (source code)	allows DEC RSX-11M/MX host to communicate over an Ethernet or internetwork of Ethernets; implements XNS/ITP specifications
NS4230 ITP/VMS	Interlan NET/PLUS, Ethernet	Interlan NI1010A Unibus Ethernet controller	DEC VAX/VMS	DEC VMS device driver, application software	2,500 (distribution kit); 25,000 (source code)	allows a DEC VAX/VMS host to communicate over an Ethernet; implements XNS/ITP specifications

NETWORKING SOFTWARE

TABLE 4

Company Package name	Network	Network hardware interface	Computer/operating system compatibility	Required additional software	Price (\$)	Function
NS4244 ITP/UNIX System V	Interlan NET/PLUS, Ethernet	Interlan NI3210 Multibus Ethernet controller	UNIX System V	UNIX System V device driver, application software	2,500 (distribution kit); 25,000 (source code service)	allows a 68000 UNIX System V host to communicate over an Ethernet; implements XNS/ITP specifications; provides transport system for one or more user-written application programs
NS4280 ITP/VS	Interlan NET/PLUS, Ethernet	Interlan NI4010A Data General Ethernet controller	Data General AOS/VS	Data General AOS/VS device driver, application software		allows a Data General MV-series computer host to communicate over an Ethernet; implements XNS/ITP specifications; provides transport system for user-written application programs
NS4290 ITP/MS-DOS	Interlan NET/PLUS, Ethernet	Interlan NI5010 IBM PC Ethernet controller	MS-DOS	MS-DOS device driver, application software	500 (distribution kit); 25,000 (source distribution kit)	allows IBM PC/XT, Compaq PC to communicate over an Ethernet; provides a complete transport system for user-written application programs
NS7430 NFS/VMS Network File Server Protocols	Interlan NET/PLUS, Ethernet	Interlan NI1010A Unibus Ethernet controller, NS4230 ITP/VMS	DEC VAX/VMS	XNS/ITP protocol software package	1,195 (distribution kit)	allows DEC VAX/VMS host system to share disk-based information with other hosts in family; forms file servers and permits files in one system to be accessed from another system on the same or remotely connected Ethernet
NS7444 NFS/UNIX File Server Protocols	Interlan NET/PLUS, Ethernet	Interlan NI3210 Multibus Ethernet controller	UNIX System V	device driver, XNS/ITP protocol software package	895 (distribution kit)	allows 68000 UNIX System V host system to communicate over an Ethernet; provides a complete transport system for user-written application programs
NS7490 NFS/MS-DOS Network File Server Protocols	Interlan NET/PLUS, Ethernet	Interlan NI5010A IBM PC Ethernet controller	MS-DOS	device driver, XNS/ITP protocol software package	195 (distribution kit)	allows MS-DOS based systems to communicate over an Ethernet; provides a complete transport system for user-written applications
METAPATH INC.						
CNM-001	ROBIN NET	IBM PC/XT/AT with asynch port	MS-DOS 2.0 or higher	MS-DOS 2.0, 2.1, 3.0 or 3.1		provides configuration and management of a Metapath network; connection logging; data generation; statistics on net operation; trans-verification tests
DFS-001 Network File Server	ROBIN NET	IBM PC/XT with asynch, parallel port	MS-DOS 2.0, or higher	file-client software that uses netfile server		provides file access, storage, retrieval, print spooling, file security
NETWORK APPLICATIONS INC.						
transNET	SNA	synch, asynch modem; SDLC	IBM MVS, VM	IBM VTAM, NCP, TSO	35,000 (base); 2,000-25,000 (options)	maintains editability on IBM, Wang, Data General and DEC office system workstations; electronic document distribution
NETWORK RESEARCH CORP.						
FUSION	Ethernet, OMNINET, proNet	XNS TCP/IP	DEC VAX/VMS, PRO-350 VENIX; IBM-PC/MS-DOS, XT VENIX; UNIX		750-6,000	a communication interface connecting PCs, micros and mainframes which facilitates remote execution, virtual terminal capabilities, internet routing and high-speed file transfer
NORTHERN TELECOM INC./DATA SYSTEMS DIV.						
3274 Emulator	SNA	bisynch modem, Northern Telecom intelligent communications adapter	Northern Telecom 4.1 Omnitask		1,850 (one-time license); 93 (monthly license)	allows Northern Telecom 4XX, 5XX systems to emulate IBM 3274 cluster controller
Network Control Program	Northern Telecom Network Control	autodialer, bisynch modem, Northern Telecom intelligent communications adapter	Northern Telecom 4.1 Omnitask		500 (one-time license)	allows Northern Telecom systems to network together; unattended data transfer between remote systems

NETWORKING SOFTWARE
TABLE 4

NETWORKING SOFTWARE

TABLE 4

Company Package name	Network	Network hardware interface	Computer/operating system compatibility	Required additional software	Price (\$)	Function
OMNIMAIL		autodialer, bisynch modem, Northern Telecom intelligent communications adapter	Northern Telecom 4.1 Omnitask		1,995 (one-time license)	proprietary electronic mail system for use with Northern Telecom 4XX, 5XX systems
ORCHID TECHNOLOGY						
PCnet	IBM PCnet	PCnet adapter card, PCnet PLUS RAM, PCnet BLOSSOM	IBM PC-DOS, MS-DOS	PCnet Mail, Command Spooler, LANComm-Multitasking	495 (PCnet); 695 (PCnet BLOSSOM); 595 (PCnet PLUS RAM)	PC to PC communication, disk sharing, caching, partitioning
ORION SOFTWARE INC.						
Network Orion	proprietary	2400, 4800 bisynch modem	IBM System 34/36/38			modular communications software may be used for singular or multiple installations; electronic mail to PC in 5251 emulation mode or Telex address; document transmission between IBM System 34/36/38 computer and Wang or IBM word processor
Telex/38	ITT Databridge	2400, 4800 bisynch modem	IBM 38 CPF		5,100-6,300	interface with Telex network; users may establish public and private distribution lists; switched communications line
PACER SOFTWARE INC.						
pcLINK	proprietary	asynch modem	Prime Primos, IBM PC, MS-DOS		2,000 (host, 5 PCs)	functional microcomputer interconnect package for Prime Computer 50 Series; IBM PC/XT/AT are target PC
PATHWAY DESIGN						
pcPATH	SNA, BSC	synch modem, communications adapter	IBM PC, MS-DOS, IBM compatibles		595; 295 (communications adapter)	allows IBM PC/XT/AT to emulate SNA, BSC; supports variety of host, communications controllers, multiple sessions; provides programmatic interface for writing custom applications
netPATH	SNA, BSC	synch modem	IBM PC, MS-DOS, IBM compatibles	DEC VAX/VMS Version 3.0-3.6, RSX-11M Version 4.1 (patch level A or B), RSX-11M + Version 2.1	795; 295 (communications adapter)	allows IBM PC/XT/AT to emulate SNA, BSC; supports variety of host, communications controllers, access methods, applications, multiple sessions; provides programmatic interfaces for writing custom applications
uniPATH	SNA, BSC	synch modem	UNIX System III, V; UNOS, XENIX		795 (5 sessions); 1,395 (16 sessions); 1,995 (32 sessions)	allows UNIX-based computer systems to emulate SNA, BSC; supports variety of IBM hosts communications controllers, access methods; up to 32 concurrent sessions; provides programmatic interfaces for writing custom applications
PRIME COMPUTER INC.						
PRIMENET	PRIMENET/RINGNET	PRIMENET Node Controller	PRIMOS	PRIMOS	7,500 (single license)	facilitates terminal connection to many network hosts, access to remote files, file transfer and information routing
TECHNOLOGY CONCEPTS INC.						
Broadway	DECnet	Ungermann-Bass NIU series	DEC VAX/VMS Version 3.0-3.6, RSX-11M Version 4.1 (patch level A or B) RSX-11M + Version 2.1	DECnet	2,500 (minimum 4 nodes); 500 (per node)	provides 5Mbps on 6MHz channel up to 9.5 miles between any DEC VAX, PDP-11 CPU
Etherway	DECnet, DEC VAX/VMS, RSX-11M	Interlan NI1010 Uni-bus, NI2010 controller	DEC VAX/VMS Version 3.0-3.6, RSX-11M version 4.1 (patch level A or B), RSX-11M + Version 2.1	DECnet	2,500 (minimum 4 nodes); 500 (per node)	provides 10Mbps Ethernet CSMA/CD across up to 2500m between DEC VAX, PDP-11 CPU

NETWORKING SOFTWARE
TABLE 4

NETWORKING SOFTWARE

TABLE 4

Company Package name	Network	Network hardware interface	Computer/operating system compatibility	Required additional software	Price (\$)	Function
Ringway	DECnet	Proteon p1000 Uni-bus proNET, p1100 Q-bus, proNET controller	DEC VAX/VMS Version 3.X, RSX-11M Version 4.1 (patch level A or B), RSX-11M+ Version 2.1	DECnet	2,500 (minimum 4 nodes), 500 (per node)	provides 10, 80Mbps token-passing ring; multiaccess up to 1.5 miles between DEC VAX, PDP-11 CPU
TEXAS INSTRUMENTS						
Distributed Network I/O (DNIO)	Ethernet, X.25	Texas Instruments EI300, EI990, XNS internet bridges	Texas Instruments Distributed Network Operating System (DNOS)	Texas Instruments Distributed Network Communications System (DNCS) required for X.25 network access	3,500 (DNIO object); 1,300 (DNCS)	provides transparent I/O to files, devices, or other programs; allows sharing of files, printers and communication gateways in a LAN or wide area network; virtual terminal capability; transparent internetwork routing
EtherSeries	Ethernet	EtherLink	MS-DOS 2.1	EtherPrint, EtherMail, EtherVoice, Business System Access	500 (EtherPrint); 750 (EtherMail); 195 (Business System Access)	provides PC disk, print and mail servers; allows client PC's to share disk, print and mail servers
TRANSACTION DATA SYSTEMS INC.						
Freedom Network System	PNF-Packet Network Facility	bisynch protocol	Perkin Elmer 0S/32		5,000 (PNF license)	provides PAD services, packet switching, adaptive routing, multiple priority levels, connected virtual channels; opt. encryption by user choice
UNISOFT SYSTEMS						
ACCESS/SNA for UniPlus+	SNA	SDLC	UNIX		10,000 (basic porting fee); 100-210 (license)	provides level of SNA protocol support used by most IBM distributed processing, office automation products
B-Net	Ethernet	Ethernet	UniPlus+	UniPlus+	400	allows any system running UniPlus+ to communicate with any other machine using TCP/IP compatible protocol; features remote file transfer, virtual terminal facilities

Information was solicited but not received from the following manufacturers:

Cadmus Computer Systems

Digital Equipment Corp

For information on their products, consult the Supplementary Directory of Manufacturers on page 113.

NETWORKING SOFTWARE
TABLE 4

QUAD3278™

It's almost like a desk-top mainframe.

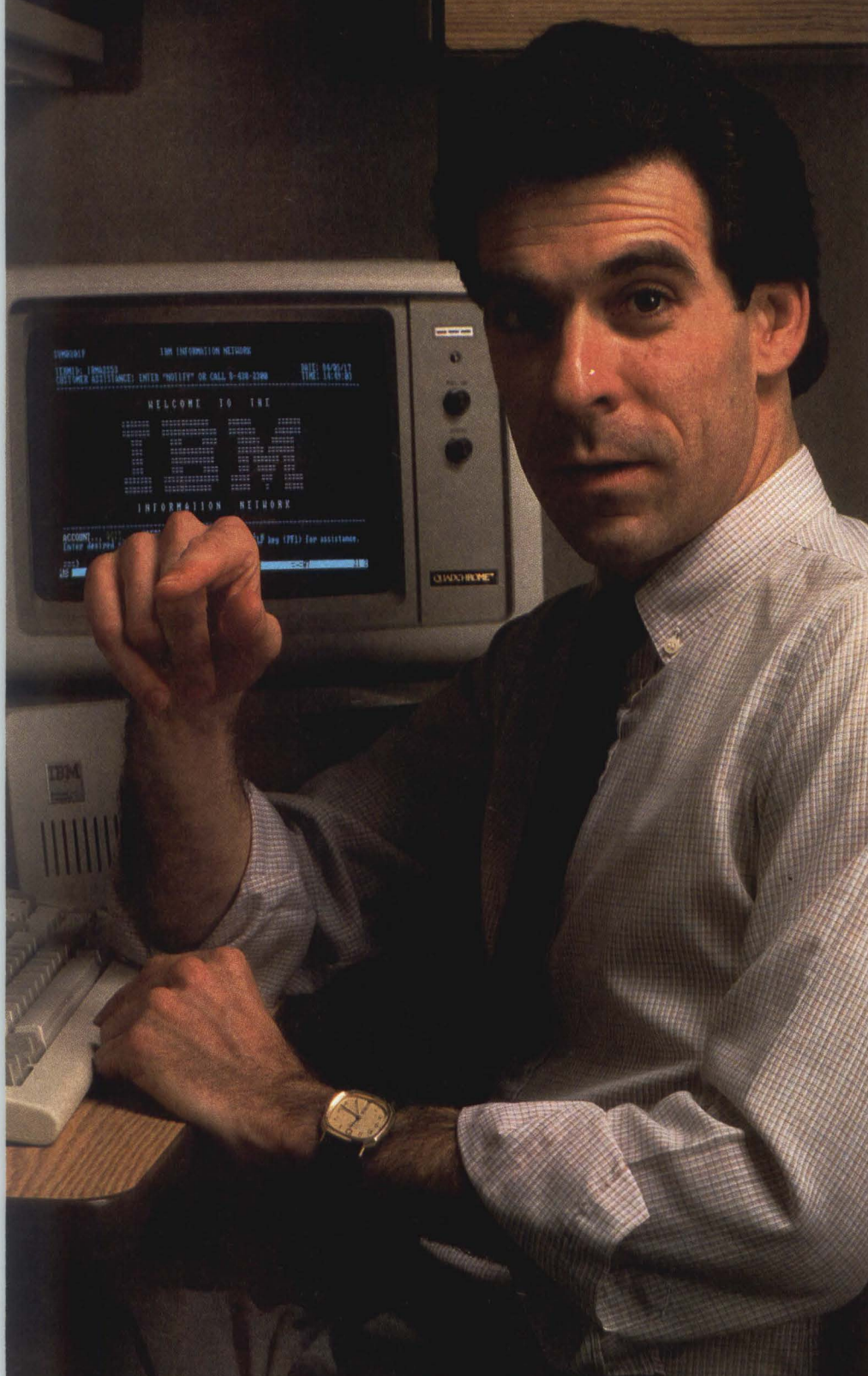

Convert your IBM PC to full 3278 emulation. And back it up with Quadram Quality.

Now you can have all the features of the IBM PC (mass storage and peripherals) plus the incredible power of a mainframe right at your desk. Introducing the new Quad3278 from Quadram. The complete system that makes your IBM PC emulate the 3278 Display Work Station at the touch of a key.

The Quad3278 contains everything you need for converting your PC to total 3278 emulation: hardware, software and full documentation. So you're quickly on-line; where the IBM mainframe sees you as just another 3278 terminal. But thanks to Quadram, you're actually a high-performance, intelligent work station.

And with Quad3278 not only do you retain all the functions of your PC but you can reconfigure your PC keyboard to personal taste. In addition, Quad3278 has its own high-speed microprocessor to keep your PC's microprocessor from being burdened with communications responsibility. And it incorporates the 3279's color mode to give you stunning color displays directly from the mainframe.

Make the connection from micro to mainframe. And back it up with Quadram Quality. Ask for Quad3278. It's the logical step for the future.



4355 International Blvd./Norcross, Ga. 30093
(404) 923-6666/TWX 810-766-4915 (QUADRAM NCRS)

INTERNATIONAL OFFICES
Interquadram Ltd. 442 Bath Road, Slough, England SL168B
Tel: 6286-63865 Tlx: 847155 Auriema G Interquadram GmbH
Fasanenweg 7, 6092 Kelsterbach, West Germany Tel: 6107-3089
Tlx: 417770 Seva G Interquadram s.a.r.l. 41, Rue Ybry, 92522 Neuilly
Tel: 758-1240 Tlx: 630842 Iso Bur Checco Computing 6581 Kitimat
Road, Mississauga, Ontario, Canada L5N-2X5 Tel: 416-821-7600

IBM® PC and IBM Information Network are registered trademarks of International Business Machines Corporation.
©Copyright 1984 Quadram Corporation.
All Rights Reserved.

CIRCLE NO. 38 ON INQUIRY CARD

VOICE-DATA INTEGRATION ENTERS WAR FOR DESKTOPS

Telephone, computer and terminal manufacturers try a new mix of product capabilities to secure larger shares of the office-automation marketplace

Jerry Borrell, Senior Western Editor

The desktop represents the battleground for vendors seeking a share of the office-automation marketplace. Until recently, firms within the computer and telephone industries competed separately. However, as each industry reached for the technology of the other, rivalry between them increased dramatically. In addition, this merging of communication and computer technology has created a new product market. The result? Integrated voice-data (IVD) products are now appearing as fierce competitors to dedicated terminals and personal computers.

Greg Carlsted, industry analyst for Dataquest Inc., San Jose, Calif., contends that IVD shipments will expand from 100,000 units in 1984 to around one million units in 1988.

As expected, each industry brings its own approach to the integration of voice and data. However, all manufacturers seek to unite telephone features (auto-dialing, electronic messaging and voice communication) and terminal functions (alphanumeric display, database access) with personal computer operations (word processing, spreadsheets). Consequently four categories for the IVD market have emerged: integrated voice-data terminals, voice-data terminals with local processing, additions to existing computers and private branch exchange (PBX) products. Although each category has its

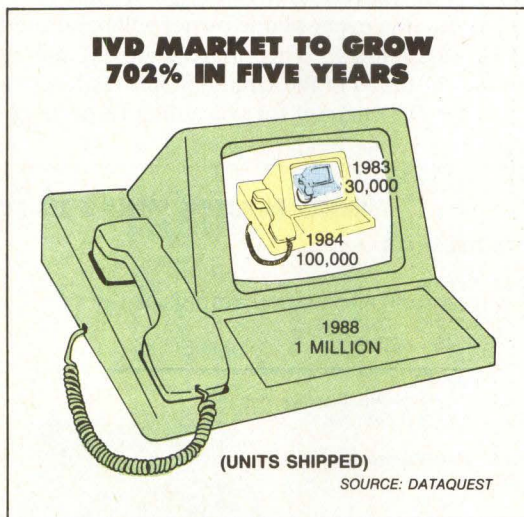

champions, industry analysts suggest that the acquisition of Rolm Corp. by IBM Corp. has positioned IBM to move into any or all of the categories.

Major market targeted

Each of the categories has a market niche, but it is difficult for system integrators to choose which features to build into their IVD products when the market is still largely undefined. Jack Conroy, chief executive officer at Santa Barbara Laboratories Inc., Santa Barbara, Calif., says

Add-on products represent the market with the greatest potential for fast, near-term growth.

300,000 office executives represent one target audience for IVD products. Another is the "knowledge worker," estimated to include 60 percent of all employed people in the United States. Specific job categories in this market include clerical workers who use terminals for data entry, airline employees who require programmable functions, professionals in medicine and law and specialists in finance and brokerage who require local processing as well as terminal functions.

Phone features desired

Some IVD manufacturers enjoy a market among users desiring access to a database, or among those who use an electronic calendar or electronic mail. These applications suit real estate, finance, banking and brokerage markets.

IVD vendors, then, offer such electronic telephone features as auto-dialing, memory, conferencing and a wide range of ASCII terminal emulation. Phone manufacturers dominate this market segment, but terminal manufacturers, notably Liberty Electronics USA, San Francisco, Calif., and TeleVideo Systems Inc., Sunnyvale, Calif., have established a presence.

Eventually, every phone owner will be offered IVD capabilities. The more-than-100-million phones installed in the United States represent a lucrative IVD market for voice-data technology.

Richard Larson, vice president for sales at Matra Communications Inc., Cupertino, Calif., thinks that, "IVD terminals are not suited for commodity-market competition because they require some software adaptation for specific users." Matra focuses on value-added-resale markets in areas such as real estate, finance, banking, brokerage and electronic mail.

Laura J. Peck, senior analyst at L.F. Rothschild, Unterberg, Towbin and Co., San Francisco, is less than sanguine about the IVD market. She points out the likelihood of "price erosion, particularly for terminal products, occurring as functionality increases." The result is likely to be the cutthroat pricing practices that affect terminal markets.

Save money with add-on products

According to industry analysts, add-on products represent the market with the greatest potential for fast, near-term growth. Manufacturers cite the large installed base of IBM PCs as having lucrative potential for add-on telephony and data-function units.

The strength of the add-on market is found, according to Charles Foskett, president of Natural MicroSystems Corp., Natick, Mass., "in the knowledge-based industries that are communications-intensive. As much as 50 percent of the small businesses in the United States fit this

WHO MAKES WHAT IN IVD PRODUCTS

INTEGRATED VOICE-DATA TERMINALS

- AMBI CORP.—Ambiterminal, Ambiset
- AMERICAN TELEPHONE & TELEGRAPH INFORMATION SYSTEMS—515 BCT
- BASIC TELECOMMUNICATIONS INC.—Datavoice 20
- GTE COMMUNICATION SYSTEMS—XT 300E
- INTEGRATED OFFICE SYSTEMS—Unity 100
- LIBERTY ELECTRONICS—Freedom 212, 222
- NORTHERN TELECOM INC.—Displayphone, Displayphone Plus
- TELEVIDEO SYSTEMS INC.—Personal Terminal
- TELRAD—Info 3000
- MATRA COMMUNICATIONS INC.—Scanset XL and 415
- ZAISAN INC.—ES.1

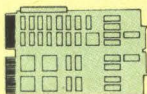

ADD-ON PRODUCTS FOR VOICE-DATA CAPABILITY

- BIZCOMP CORP.—Intellimodem (IBM PC family)
- CYGNET TECHNOLOGIES INC.—Cosystem (Standalone and IBM PC family)
- GANDALF DATA INC.—LineMiser (IBM PC family)
- NATURAL MICROSYSTEMS—Watson (IBM PC family)
- NORTHERN TELECOM INC./DRI—Starlink (IBM PC family)
- SYDIS INC.—VoiceStation (IBM PC family)
- WILCOM INC.—Asher (IBM PC family)
- VOAD SYSTEMS—Keyboard Phone (IBM PC family)

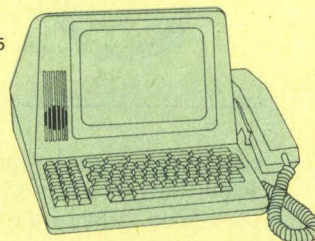

VOICE-DATA TERMINALS WITH LOCAL PROCESSING

- MITEL CORP.—Kontakt
- SANTA BARBARA LABORATORIES—Centerpoint 1000
- WANG LABORATORIES INC.—Intecom
- ZAISAN INC.—ES.3

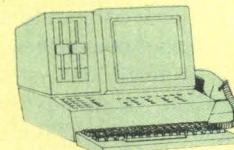

MULTIUSER OR PBX-RELATED

- AMERICAN TELEPHONE & TELEGRAPH INFORMATION SYSTEMS—Merlin
- DAVID SYSTEMS—Information Manager
- DAVOX COMMUNICATIONS CORP.—Davoxnet, Davox Workstations
- HONEYWELL INC.—Deltaplex
- ROLM CORP.—Cypress (terminal), Juniper (IBM PC add-on), Cedar (IVD terminal with local processing)
- SYDIS INC.—Voice Station One, Voice Station 110

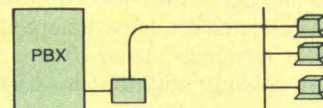

profile, and each one of these professionals, managers, executives and assistants might have access to a PC." The company's Watson add-on board for the IBM PC is an expensive alternative to an IVD. It costs about \$1,000. "The most important consideration in IVD," says Foskett, "is voice communications. Typically, 90 percent of office communications is verbal." The single Watson board incorporates the three principles that Foskett believes are needed in this market: telephone management (including records of the number dialed and the duration of each call), voice communications (including voice storage and forwarding) and data communications (including auto-logon and terminal emulation).

Amy E. Smith, senior research analyst for The Yankee Group, Boston, agrees that "this product category has the largest growth potential in the short term because of the large number of PCs installed. Over the longer term, PBX and PC vendors will be offering IVD products, but probably not until the next PC cycle."

Dennis Haar, product manager for Rolm, Santa Clara, Calif., notes that the "footprint" factor is important. If the professional already has a PC on the desktop, use of an add-on card provides the PC with more productivity without loss of desk space.

A second category of add-on products concerns external products connected to the IBM PC. Such products include Cosystem from Cygnat Technologies Inc., Sunnyvale, Calif.; Line Miser from Gandalf Data Inc., Wheeling, Ill.; and Keyboard Phone from Voad Systems Inc., Los Angeles. Jerry Klein, vice president of marketing for Cygnat, says, "Cosystem provides a concurrent multitasking environment for the IBM PC, allowing the user to do more than one job at once." Few add-on products have this capability, which merely requires, for example, "that the user leave the PC on in order to receive or make a phone call." Both the Gandalf and Voad products can be used with any computer or terminal, a telephone and an RS232 port.

Stretches the PC dollar

The addition of voice and data capability to desktop computers provides dual advantages for system integrators. One set of advantages is best demonstrated in the consolidation of functions found in existing desktop products. If a Rolodex, phone-answering device, note pad, typewriter, phone, word processor and computer are integrated into a single product, system integrators can claim cost savings along with productivity improvements.

Of the five companies currently selling com-

puters with IVD capability, none are among the top sellers of desktop computers. Peck of L.F. Rothschild, Unterberg, Towbin expects there to be 10 companies in the IVD local processing sector next year at this time. "Personal computer manufacturers, such as Apple, Compaq and Hewlett-Packard, must realize," he says, "that these products present formidable competition for them, while PBX manufacturers, such as Intecom and Ztel, recognize this sector as a

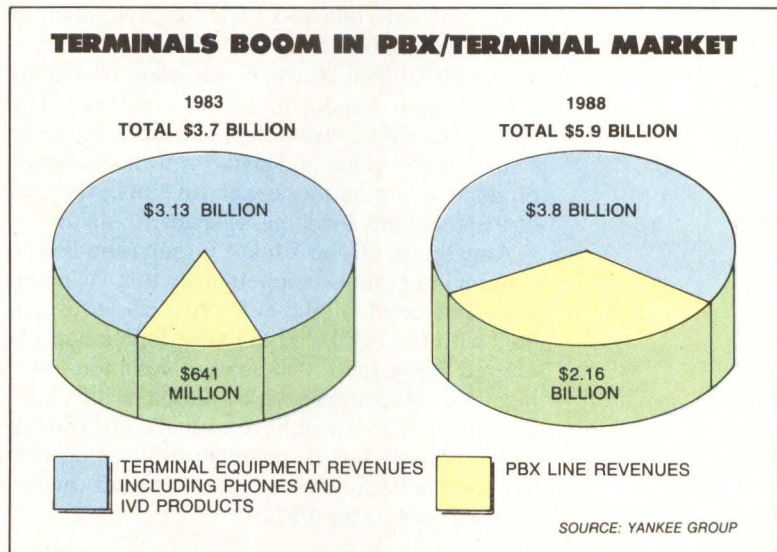

natural add-on sale for the PBX." In fact, two PBX companies have recently formed joint OEM agreements: Intecom Inc., Allen, Texas, with Wang Laboratories Inc., and Santa Barbara Development Laboratories with Hewlett-Packard Co., Palo Alto, Calif. A third agreement, between AT&T and Convergent Technologies Inc., Santa Clara, Calif., was tentatively scheduled for last month.

Zaisan Inc., Houston, participates in both the terminal and the terminal/personal computer markets. Steve Fowler, director of marketing and one of the company's founders, says Zaisan is seeking the white-collar professional: "...sales people, insurance agents, lawyers and stock brokers." The Zaisan product operates independently of any PBX, but requires two lines for simultaneous voice and data transmissions. The trade-off, declares Fowler, "is that we are able to offer telephony, terminal and computer functions at a price competitive with a plain PC, and at half the cost of Rolm's Juniper/PC combination, which still requires a proprietary PBX."

IVD products can be tied directly to a central communications controller, such as a PBX. There are advantages and disadvantages to this

approach. Rolm's Harr summarizes the benefits to buyers. "The first advantage is speed. With proprietary software, we can transmit data over twisted pair at rates to 19.2K baud. When corporate users want to access a central database, the advantage of a high transmission rate is obvious.

The second advantage relates to the mainframe. When 20 users want to access five ports on the mainframe, the PBX can handle all the queuing. Finally, by using proprietary software, we can use one twisted pair and offer not only voice and data but also PBX functions such as call parking, hold, transfer and speedcall."

The PBX functions can be sufficient reason for purchasing a vendor-proprietary system. The cost of installing two telephone lines to allow simultaneous voice and data on terminal-based products might be more expensive than the cost of PBX systems for large-user environments.

Amy Smith of The Yankee Group is bullish on system integrators competing in this segment. "At some point, all the IVD products are associated with the PBX, and the most functionality is offered when these two share a common interface. Manufacturers such as Zaisan, which have generic products, will have to make OEM deals with PBX vendors to compete in the long run. This is true because of the need for performance features tied to the PBX."

Caution advised

Nevertheless, OEMs and large-volume end users must consider this option carefully. By integrating IVD equipment tied to a PBX, they are constrained to use only those IVD products compatible with the PBX's software. Also, system integrators tie their fortunes to the fortunes of a chosen PBX vendor.

Although Honeywell Inc., Minneapolis, Minn., and Rolm have an early lead in developing IVD devices for proprietary PBXes, two other companies, Davox Corp., Billerica, Mass., and Sydis Inc., San Jose, Calif., are the first companies to supply multiuser IVD systems. Davox chose to provide IVD for the IBM 3270 marketplace. Deirdre Searles, director of marketing for Davox, divides the IVD market into two classes: "...one for high-speed synchronous products, such as those from IBM, and one for asynchronous environments, which must use protocol converters. The asynchronous market is more appropriate for executive workstations, such as those from Zaisan."

Davox expects to have more than one million units in the synchronous 3270 market by 1988 with its IVD terminal and its multiuser, mini-computer network facility called DavoxNet. It is

in large-user networks, says Searles, "that Davox offers the greatest advantage. The new Cedar product from Rolm, for example, costs about \$5,000, whereas our system in a multiuser environment can bring the individual terminal cost down to \$2,500." Davox also allows the system to be configured over existing twisted-

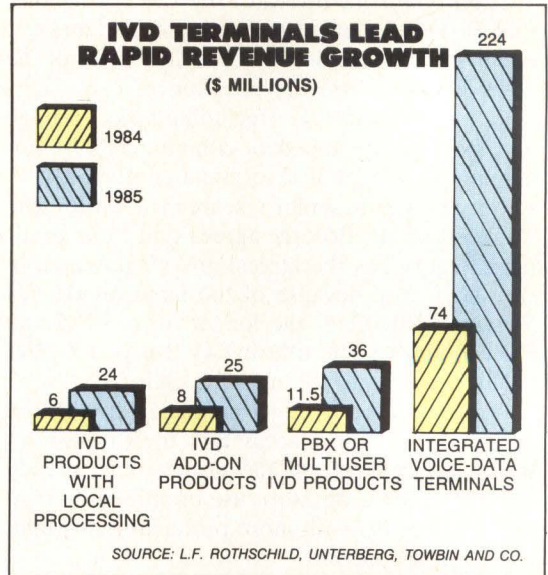

pair phone connections.

Sydis has chosen a proprietary multiuser computer system for its voice-data products. According to Ken Gilbert, director of product marketing, Sydis sells multiuser computers to the management information systems market. Part of the impetus for this market, says Gilbert, "was given by the IBM PC. As they went into office environments, users began to connect the PC to the IBM mainframe, demanding CPU time and forcing the MIS group to find independent supporting computers to offload the host." The Sydis product performs this work in addition to offering the user IVD capability.

The Sydis multiuser computer works with the customer's existing analog PBX. Gilbert explains that, "85 to 90 percent of existing PBX equipment is analog. Sydis offers an advantage to all PBX owners, allowing them to retain their current systems for five to seven more years, rather than forcing them to add digital PBX equipment to obtain an IVD system." □

Interest Quotient (Circle One)
High 462 Medium 463 Low 464

What Lear Siegler Does Best We Also Do Special.



As standard products or OEM specials, Lear Siegler video display terminals convey the look and feel of quality your systems deserve.

With Lear Siegler terminals as your primary operator interface, your products will be more attractive, more reliable, easier to use, and more marketable than ever.

We will custom tailor Lear Siegler's superior performance, ergonomic design and exclusive High Touch™ style to meet your exact requirements—from simple logo changes to

completely unique terminal designs and proprietary firmware. Our dedicated OEM sales



Complete OEM design, engineering, assembly and testing are performed at Lear Siegler's Anaheim, CA. facility.

and engineering groups are terminal experts who specialize in serving your needs. And they're backed by Lear Siegler's proven experience and reputation as an OEM supplier.

Call or write today for complete information on how Lear Siegler's OEM capabilities can work for you.



**LEAR SIEGLER, INC.
DATA PRODUCTS DIVISION**

901 E. Ball Road Anaheim, CA. 92805
(714) 778-3500

VOICE/DATA TERMINALS

TABLE 5A

Company Model	Terminal type	Display size, color (diagonal inches)	Screen format (col. x lines)	Interfaces (protocols)	Emulations	Price (\$)	Notes, features, options
AMBI CORP.							
Ambiset	intelligent	9-inch, b&w	80 x 8	RS232C, RJ11 (2)	DEC VT100	1,195	10 programmable function keys, portable, electronic mail, interfaces with Bell 103, 212A modem
Ambiterminal	intelligent	9-inch, green	80 x 24	RS232C, RJ11 (2)	DEC VT100	1,195	10 programmable function keys, electronic mail, interfaces with Bell 103, 212A modem
BASIC TELECOMMUNICATIONS INC.							
Datavoice Model 10	intelligent	9-inch, green	80 x 24	RS232C (X-on/X-off)	Lear Siegler ADM 31, ADDS Viewpoint, DEC VT52		Z80 microprocessor with 16K RAM, program memory, RJ11C network interface
Datavoice Model 20	intelligent	9-inch, green	80 x 24	RS232C (X-on/X-off)	Lear Siegler ADM 31, ADDS Viewpoint, DEC VT52	1,995	tape deck for electronic voice mail, RJ11C network interface
BIZCOMP CORP.							
Intellimodem XL add-on device to IBM PC				RJ11C (2) (X-on/X-off, asynch modem)	DEC VT52, VT100, TTY		includes Intellisoft software, auto dial, auto redial, auto answer, RJ11C network interface
CYGNET TECHNOLOGIES INC.							
Cosystem external add-on device for IBM PC						1,495-1,845	36 function keys, auto dial, auto redial, electronic phone directory, speakerphone
DAVOX CORP.							
811 Intelligent Workstation	intelligent	12-inch; amber, green	80 x 25	DavoxNet, RS232C (asynch, bisynch, SDLC, SNA)	IBM 3278/2, 3178; DEC VT52	1,795	24 programmable function keys
821 Intelligent Workstation	intelligent	12-inch; amber, green	80 x 25	DavoxNet, RS232C (asynch, bisynch, SDLC, SNA)	IBM 3278/2, 3178; DEC VT52	1,995	24 programmable function keys
911 Intelligent PC Workstation	intelligent	12-inch; amber, green	80 x 25	DavoxNet, RS232C (asynch, bisynch, SDLC, SNA)	IBM 3278/2, 3178; DEC VT52, VT100	1,980	24 programmable function keys
921 Professional PC Workstation	intelligent	12-inch; amber, green	80 x 25	DavoxNet, RS232C asynch, bisynch, SDLC, SNA)	IBM 3278/2, 3178; DEC VT52, VT100	2,180	24 programmable function keys
DavoxNet 1821 Intelligent Workstation	intelligent	12-inch; amber, green	80 x 25	DavoxNet, RS232C (asynch, bisynch, SDLC, SNA)	IBM 3278/2, 3178; DEC VT52	2,310	24 programmable function keys, simultaneous voice/data on twisted-pair telephone wires
DavoxNet 1911 Intelligent PC Workstation	intelligent	12-inch; amber, green	80 x 25	DavoxNet, RS232C (asynch, bisynch, SDLC, SNA)	IBM 3278/2, 3178; DEC VT52, VT100	2,295	24 programmable function keys
DavoxNet 1921 Professional PC Workstation	intelligent	12-inch; amber, green	80 x 25	DavoxNet, RS232C (asynch, bisynch, SDLC, SNA)	IBM 3278/2, 3178; DEC VT52, VT100	2,495	24 programmable function keys

VOICE/DATA TERMINALS
TABLE 5A

Company Model	Terminal type	Display size, color (diagonal inches)	Screen format (col. x lines)	Interfaces (protocols)	Emulations	Price (\$)	Notes, features, options
2911 Professional Color Workstation	intelligent/graphics	12-inch; blue, green, pink, red, turquoise, yellow, white	80 x 25	DavoxNet, RS232C (asynch, bisynch, SDLC, SNA)	IBM 3279; DEC VT52, VT100	5,600	24 programmable function keys, bit-mapped graphics
2921 Professional Color Workstation	intelligent/graphics	12-inch; blue, green, pink, red, turquoise, yellow, white	80 x 25	DavoxNet, RS232C (asynch, bisynch, SDLC, SNA)	IBM 3279; DEC VT52, VT100	5,700	24 programmable function keys, bit-mapped graphics
3911 Professional Color Workstation	intelligent/graphics	12-inch; blue, green, pink, red, turquoise, yellow, white	80 x 25	DavoxNet, RS232C (asynch, bisynch, SDLC, SNA)	IBM 3279; DEC VT52, VT100	5,915	24 programmable function keys, bit-mapped graphics
3921 Professional Color Workstation	intelligent	12-inch; blue, green, pink, red, turquoise, yellow, white	80 x 25	DavoxNet, RS232C (asynch, bisynch, SDLC, SNA)	IBM 3279; DEC VT52, VT100	6,015	24 programmable function keys, bit-mapped graphics
GTE COMMUNICATION SYSTEMS							
XT300	intelligent/graphics	9-inch, b&w	80 x 25	RS232C, RJ11, RJ12, RJ13 (X-on/X-off)	DEC VT100	1,295	mosaic graphics, interfaces with 1200 bps modem, built-in RS232C port
XT300E	intelligent/graphics	9-inch, b&w	80 x 25	RS232C, RJ11, RJ12, RJ13 (X-on/X-off)	DEC VT100	1,395-1,695	16 programmable function keys, dedicated stop/start, interfaces with 1200-bps modem, built-in RS232C port
HONEYWELL INC.							
Deltaplex Series 2000	PBX system	b&w	80 x 3	coaxial, twisted-pair, fiberoptic (proprietary)			32 channel pulse code modulation
INTECOM INC.							
InteCom/Wang Integrated Workstation	intelligent	9-inch, green	80 x 25	RS232C (asynch, bisynch, SNA, SDLC)	DEC VT100, IBM 3101, 3270		available mid-1985, InteCom Intelligent Branch Exchange (IBX) network interface
INTEGRATED OFFICE SYSTEMS							
Unity 100	intelligent	6.5-inch, grey	40 x 8	RS232C, RJ11C, TTY (SDLC, IBM 2780/3780, bisynch)		3,600	5 programmable function keys, data input, remote access file, portable
LIBERTY ELECTRONICS							
Freedom 212	editing	12-inch; green, amber	80 x 24	RS232C, RJ11, RJ12, RJ13	Liberty 200, TeleVideo 950, Lear Siegler ADM 31	1,295	10 function keys, auto dial, auto answer, auto log-on
Freedom 222	editing	12-inch; green, amber	80 x 24	RS232C, RJ11, RJ12, RJ13 (X-on/X-off, DTR)	DEC VT52, VT100, VT220	1,395	10 function keys, auto dial, auto answer, auto log-on
MATRA COMMUNICATION INC.							
Scanset 415HS	intelligent	9-inch, green	80 x 24	RS232C, RJ11C (X-on/X-off)		1,095	6 function keys, auto dial, auto log-on, RJ11C network interface
Scanset XLHS	intelligent	9-inch, green	80 x 24	RS232C, RJ11C (X-on/X-off)		1,395	6 function keys, auto dial, auto log-on, RJ11C network interface

VOICE/DATA PRODUCTS
TABLE 5A

**VOICE/DATA TERMINALS
TABLE 5A**

Company Model	Terminal type	Display size, color (diagonal inches)	Screen format (col. x lines)	Interfaces (protocols)	Emulations	Price (\$)	Notes, features, options
NORTHERN TELECOM INC.							
Displayphone	editing	7-inch, white	80 x 25	RS232C		1,295	2 pages of memory, 5 programmable function keys, calendar/clock, auto dial
Displayphone Plus	intelligent	7-inch, amber	80 x 25	RS232C, RS470, RS478	DEC VT100, VT52, IBM 3101, ADDS Viewpoint, Regent	1,595	5 programmable function keys, auto dial, auto answer, calendar/clock
Starlink add-on device to any IBM PC family and compatibles						1,800 (station)	
RACAL-MILGO INC.							
8000 Series	editing	15-inch; green	80 x 24	RS232C (Bell 8A1, DEC VT220, IBM 3270, Univac 400)			
Voice Station 110 add-on hardware and software device to IBM PC					any ANSI 3.64, DEC VT100		RJ11C network interface
TELEVIDEO SYSTEMS INC.							
Personal Terminal	editing	9-inch; yellow, green	80 x 24	RS232C, RJ11 (X-on/X-off, DTR, asynch, ASCII)		499-1,127	14 programmable function keys; non-volatile setup mode; alternate character set; interfaces with 300-1200-bps asynch modem; Bell 103-, 212A-compatible; portable
TELRAD							
INFO 4000	dumb	9-inch, green	80 x 25	RS232C, TTY, opt. RS422 (asynch, ASCII)	DEC VT52, VT100, IBM 3101		12 function keys, touch screen, auto log-on, auto dial
VOAD SYSTEMS							
Keyboard Phone Peripheral add-on device to any RS232C port						209-249	wake-up, phone directory, auto dial, interfaces with RJ11, RJ31X
WILCOM INC.							
Asher II add-on device to any IBM model					IBM PC		help function, calendar, auto dial

VOICE/DATA COMPUTERS

TABLE 5B

Company Model	Display size color/screen format (col. x lines)	CPU type	Minimum (maximum) memory size in bytes	Operating system	Programming languages (terminal emulations)	Price (\$)	Notes, features, options
MITEL CORP.							
KONTACT WORKSTATION	12-inch, green (31 x 80)	Motorola 6809	256K (256K)	proprietary, SB-80	major languages through SB-80 (emulates DEC VT52, VT100; IBM 3278)	4,900	two 350K-byte 5¼ inch diskette drives, 10M-byte hard disk drive, CP/M-80-compatible, electronic mail
NATURAL MICROSYSTEMS							
Watson			192K (192K and up)	IBM PC-DOS		849-998	IBM PC-compatible
POLYMORPHIC SYSTEMS							
Poly 186	14-inch, 16-color (80 x 26)	Intel 80186	512K (2M)	PC-DOS, UNIX	BASIC, Assembler, Pascal C, FORTRAN (emulates DEC VT100, VT220; IBM 3270; Tektronix)		up to four 800K-byte 5¼ inch diskette drives, 80M-byte hard disk drive; opt. light pen, mouse, digitizer
ROLM CORP.							
CEDAR	9-inch, 8-color (80 x 25)	Motorola 8088	512K (512K)	MS-DOS 2.11	GW BASIC (emulates DEC VT100, IBM 3270)	4,245	two 360K-byte 5¼ inch diskette drives, battery backup, speakerphone, auto dial, IBM PC-compatible
SANTA BARBARA LABORATORIES INC.							
Centerpoint 1000	14-inch, green (84 x 24)	Intel 80186	512K (2M)	MS-DOS, CP/M-86	Personal BASIC (emulates DEC VT100)	60,000 (4 users)	one 512K-byte 5¼ inch diskette drive, 80M-byte hard disk drive, spreadsheet, touch screen, electronic mail
ZAISAN INC.							
ES.3	16-color	Motorola Z.80, CMOS 6805, 8088	128K (640K)	MS-DOS 2.0	GW BASIC (emulates TTY, Lear Siegler ADM 3A)	2,595	13 programmable function keys, IBM PC-compatible

DIRECTORY OF MANUFACTURERS

3COM CORP.

1390 Shorebird Way
P.O. Box 7390
Mountain View, CA 94039
(415) 961-9602
Table 3
Circle 334

AMBI CORP.

1033 Washington Blvd.
Stamford, CT 06901
(203) 323-9811
Table 5A
Circle 335

**AMERICAN MICROSYSTEMS
INC. (AMI)**

3800 Homestead Rd.
Santa Clara, CA 95051
(408) 246-0330
Table 1
Circle 336

ANCHOR AUTOMATION

6913 Valjean Ave.
Van Nuys, CA 91406
(818) 997-7758
Table 1
Circle 337

APPLE COMPUTER INC.

20525 Mariani Ave.
Cupertino, CA 95014
(408) 996-1010
Table 1
Circle 338

**APPLIED INFORMATION
SYSTEMS INC.**

500 Eastowne Dr., Suite 207
Chapel Hill, NC 27514
(919) 942-7801
Table 4
Circle 339

APPLITEK CORP.

107 Audubon Rd.
Wakefield, MA 01880
(617) 246-4500
Table 3
Circle 340

AST RESEARCH INC.

2121 Alton Ave.
Irvine, CA 92714
(714) 863-1333
Table 1, 3
Circle 341

AVANTI COMMUNICATIONS

Aquidneck Industrial Park
Newport, RI 02840
(800) 535-3550
Table 2
Circle 342

BASIC**TELECOMMUNICATIONS INC.**

4414 E. Harmony Rd.
Fort Collins, CO 80525
(303) 226-4688
Table 5A
Circle 343

BAY TECHNICAL ASSOCIATES

Highway 603, P.O. Box 387
Bay St. Louis, MS 39520
(800) 523-2702
Table 2
Circle 344

BIZCOMP CORP.

532 Mercury Dr.
Sunnyvale, CA 94086
(408) 733-7800
Table 1, 5A
Circle 345

**BRIDGE
COMMUNICATIONS INC.**

1345 Shorebird Way
Mountain View, CA 94043
(415) 969-4400
Table 3, 4
Circle 346

BYTCOM

2169 Francisco Blvd. Unit H
San Rafael, CA 94901
(415) 485-0700
Table 1
Circle 347

**CASE RIXON
COMMUNICATIONS INC.**

2120 Industrial Pkwy.
Silver Spring, MD 20904
(301) 622-2121
Table 1, 2
Circle 348

**CERMETEK
MICROELECTRONICS INC.**

1308 Borregas
Sunnyvale, CA 94088
(408) 752-5000
Table 1
Circle 349

**CHUNG
TELECOMMUNICATIONS INC.**

4046 Ben Lomand Dr.
Palo Alto, CA 94306
(415) 858-2456
Table 2
Circle 350

CINCOM SYSTEMS INC.

2300 Montana Ave.
Cincinnati, OH 45211
(513) 662-2300
Table 4
Circle 351

CODEX CORP.

20 Cabot Blvd.
Mansfield, MA 02048
(617) 264-2576
Table 1, 2, 4
Circle 352

**CODENOLL
TECHNOLOGYCORP.**

1086 North Broadway
Yonkers, NY 10701
(914) 965-6300
Table 3
Circle 353

**COHERENT
COMMUNICATIONS
SYSTEMS CORP.**

60 Commerce Dr.
Hauppauge, NY 11788
(516) 231-1550
Table 1, 2, 3
Circle 354

COMDESIGN INC.

751 S. Kellogg Ave.
Goleta, CA 93117
(805) 964-9852
Table 1, 2
Circle 355

**COMMUNICATIONS
MACHINERY CORP.**

1421 State St.
Santa Barbara, CA 93101
(805) 963-9471
Table 3, 4
Circle 356

**COMMUNICATIONS
SOLUTIONS INC.**

992 S. Saratoga-Sunnyvale Rd.
San Jose, CA 95129
(408) 725-1568
Table 4
Circle 357

COMPLEXX SYSTEMS INC.

4930 Research Dr.
Huntsville, AL 35805
(205) 830-4310
Table 2, 3
Circle 358

COMREX INTERNATIONAL

3701 Skypark Dr., #120
Torrance, CA 90505
(213) 373-0280
Table 1
Circle 359

COMMTX INC.

2411 Crofton Lane
Crofton, MD 21114
(301) 721-3666
Table 3
Circle 360

**CONCORD DATA
SYSTEMS INC.**

303 Bear Hill Rd.
Waltham, MA 02154
(617) 890-1394
Table 1, 2, 3
Circle 361

CORVUS SYSTEMS INC.

2100 Corvus Dr.
San Jose, CA 95124
(408) 559-7000
Table 3, 4
Circle 362

COSI

313 N. 1st St.
Ann Arbor, MI 48108
(313) 665-8778
Table 4
Circle 363

CYB SYSTEMS INC.

6448 Highway 290 E, D-111
Austin, TX 78723
(512) 458-3224
Table 3
Circle 364

**CYGNET
TECHNOLOGIES INC.**

1296 Lawrence Station Rd.
Sunnyvale, CA 94089
(408) 734-9946
Table 5A
Circle 365

DATABIT INC.

110 Ricefield Lane
Hauppauge, NY 11788
(516) 435-4000
Table 1, 2
Circle 367

**DATA COMMUNICATIONS
BROKERS INC.**

4 Henson Place
Champaign, IL 61820
(217) 352-3207
Table 1, 2
Circle 367

DATA GENERAL CORP.

4400 Computer Dr.
Westboro, MA 01580
(617) 366-8911
Table 3, 4
Circle 368

DATAGRAM CORP.

11 Main St.
E. Greenwich, RI 02818
(800) 235-5030
Table 1, 2
Circle 369

DATAPPOINT CORP.

9725 Datapoint Dr.
San Antonio, TX 78284
(512) 699-7000
Table 3
Circle 370

DATEC INC.

200 Eastowne Dr. Suite 116
Chapel Hill, NC 27514
(800) 334-7722
Table 1
Circle 371

DATATEL INC.

Cherry Hill
Industrial Center
Pin Oak & Springdale Rds.
Cherry Hill, NJ 08003
(609) 424-4451
Table 2
Circle 372

DAVONG SYSTEMS INC.

217 Humboldt Ct.
Sunnyvale, CA 94086
(408) 734-4900
Table 3, 4
Circle 373

DAVOX CORP.

4 Federal St.
Billerica, MA 01821
(617) 667-4455
Table 5A
Circle 374

DEVELCON ELECTRONICS INC.

744 Nina Way
Warminster, PA 18974
(215) 443-5450
Table 1, 2
Circle 375

DIGITAL COMMUNICATIONS ASSOCIATES INC. (DCA)

303 Technology Park
Norcross, GA 30092
(404) 448-1400
Table 1, 2
Circle 376

DIGITAL MICROSYSTEMS INC.

1840 Embarcadero
Oakland, CA 94606
(415) 261-1034
Table 3, 4
Circle 377

DOELZ NETWORKS INC.

18581 Teller Ave.
Irvine, CA 92715-1693
(714) 851-2223
Table 2
Circle 378

EMULEX CORP.

3545 Harbor Blvd.
Costa Mesa, CA 92626
(714) 662-5600
Table 2
Circle 379

EQUINOX SYSTEMS

12041 SW 144 St.
Miami, FL 33186
(305) 255-3500
Table 3
Circle 380

EXCELAN INC.

2180 Fortune Dr.
San Jose, CA 95131
(408) 945-9526
Table 3, 4
Circle 381

GTE COMMUNICATION SYSTEMS

12502 Sunrise Valley Dr.
Reston, VA 22096
(703) 435-7400
Table 5A
Circle 382

How To Delight Your Lotus With Mainframe Data

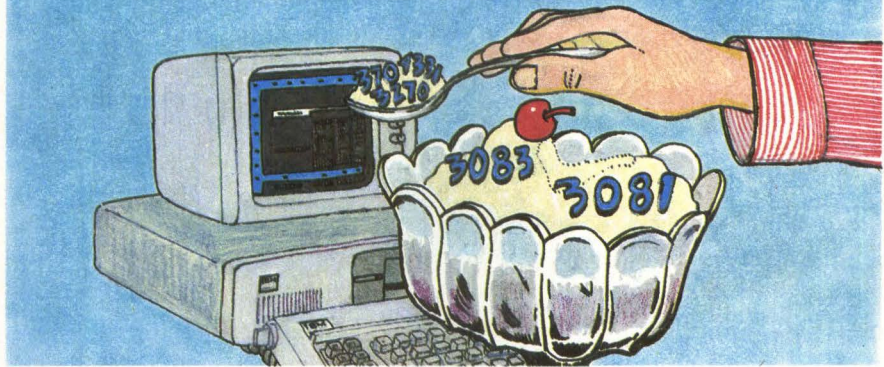

Another Smart Solution From AVATAR

The idea is simple. Make your PC spreadsheet even more powerful by giving it mainframe data. But getting that data out of your mainframe, into your PC and onto your spreadsheet isn't that simple.

Until now, you've had three choices. Transfer entire files from the host and risk choking your PC with data. Not very efficient. Or find the information in printed reports, then reenter and reformat it. Very tedious. And the alternative of asking your DP department to write special host software... well, they're overburdened already. Three choices, no real solution.

Now there's TURBO, the newest micro-to-mainframe link from AVATAR.

TURBO's Data Capture lets you select just the information you need from the mainframe. And use it immediately in any of your PC applications—Lotus, dBASE, you name it. Without rekeying, reformatting, re-anything.

And you can use TURBO's host-assisted File Transfer the way file transfer was meant to be used—for sharing data with other PC users on the 3270 network.

If that isn't enough, TURBO's exclusive Macro Language adds a whole new dimension to your micro-to-mainframe link. Use Macros to automate file transfer and data capture. Better yet, massage host data even before feeding it to your spreadsheet.

So give your PC a TURBO from AVATAR. And delight your Lotus with mainframe data.

AVATAR

The Link That Thinks

Avatar Technologies Inc.
99 South Street
Hopkinton, MA 01748
(617) 435-6872

Allied Computer Group
(414) 961-8808
Computer Communication Connection
(213) 306-5469
Digital Computer Products
(415) 349-5699
Polygon Associates
(314) 576-7709
WA Brown Instruments
(305) 776-4800

International
France/Belgium
ISTA-Imatic
(01) 630 21 46
Sweden
Databolin
(08) 714 00 00

Butler Associates
(617) 964-5270
Data Aids Associates
(713) 353-7728
Innovative Computer Marketing
(803) 288-2422
Portable Computer Systems
(609) 429-6162
XPOINT
(404) 446-2764

Australia/New Zealand
Datatran
(03) 729-2844
Italy
Macronics
(02) 68 82 141
UK/Ireland
Interlekt Electronics
(0734) 589551

Capital Systems
(703) 892-1150
Data Processing Sciences
(513) 961-0776
Kaltronics Distributing
(312) 291-1220
Servitronics
(313) 273-0036

Canada
Ahearn & Soper
(416) 675-3999
Norway
Norwegian Data Comm
(02) 68 89 83
W. Germany/Austria
Stemmer Elektronik
(089) 80 60 61

All product information is subject to change without notice.

© 1984 Avatar Technologies Inc. Lotus is a registered trademark of Lotus Development Corporation.
dBASE is a trademark of Ashton-Tate, Inc.

GAMMA TECHNOLOGY INC.

2452 Embarcadero Way
Palo Alto, CA 94303
(415) 856-7421
Table 1
Circle 383

GANDALF DATA INC.

1019 S. Noel
Wheeling, IL 60090
(312) 541-6060
Table 1, 2, 3
Circle 384

GATEWAY COMMUNICATIONS INC.

16782 Redhill Ave.
Irvine, CA 92714
(714) 261-0762
Table 3, 4
Circle 385

GENERAL DATACOMM INDUSTRIES INC.

Middlebury, CT 06762-1299
(203) 574-1118
Table 1, 2
Circle 386

GOULD AMI

3800 Homestead Rd.
Santa Clara, CA 95051
(408) 246-0330
Table 1
Circle 387

H&A COMPUTER SYSTEMS INC.

30 Hotaling Place
San Francisco, CA 94111
(415) 434-3517
Table 4
Circle 388

HALCYON

2121 Zanker Rd.
San Jose, CA 95131
(408) 293-9970
Table 1, 2
Circle 389

HAYES MICROCOMPUTER PRODUCTS INC.

5923 Peachtree Industrial Blvd.
Norcross, GA 30092
(404) 449-8791
Table 1
Circle 390

HONEYWELL INC.

Honeywell Plaza
Minneapolis, MN 55408
(612) 870-5842
Table 5A
Circle 391

HONEYWELL INC.

200 Smith St.
Waltham, MA 02154
(617) 895-6000
Table 4
Circle 392

IDE ASSOCIATES INC.

35 Dunham Rd.
Billerica, MA 01821
(617) 663-6878
Table 3
Circle 393

INFINET INC.

6 Shattuck Rd.
Andover, MA 01810
(617) 681-0600
Table 1
Circle 394

INFOTRON SYSTEMS CORP.

9 North Olney Ave.
Cherry Hill Industrial Center
Cherry Hill, NJ 08003
(609) 424-9400
Table 1, 2
Circle 395

INMAC/DATACOM DIV.

2350 Zanker Rd.
San Jose, CA 95131
(408) 945-1800
Table 1
Circle 396

INNOVATEK MICROSYSTEMS INC.

Smithfield Rd.
Millerton, NY 12546
(914) 373-9003
Table 4
Circle 397

INTECOM INC.

601 InteCom Dr.
Allen, TX 75002
(214) 727-9141
Table 3, 5A
Circle 398

INTEGRATED OFFICE SYSTEMS

20740 Valley Green Dr.
Cupertino, CA 95014
(408) 257-0171
Table 5A
Circle 399

INTELLIGENT TECHNOLOGIES INTERNATIONAL CORP.

151 University Ave.
Palo Alto, CA 94301
(415) 328-2411
Table 4
Circle 400

INTERLAN INC.

3 Lyberty Way
Westford, MA 01886
(617) 692-3900
Table 3, 4
Circle 401

INTERTEC DATA SYSTEMS CORP.

2300 Broad River Rd.
Columbia, SC 29210
(803) 798-9100
Table 3
Circle 402

KINEX CORP.

6950 Bryan Dairy Rd.
Largo, FL 33543
(800) 237-8121
Table 1
Circle 403

LEXICON CORP.

1541 N.W. 65th Ave.
Ft. Lauderdale, FL 33313
(305) 792-4400
Table 1
Circle 404

LIBERTY ELECTRONICS

625 Third St.
San Francisco, CA 94107
(415) 543-7000
Table 5A
Circle 405

MAGNOLIA MICROSYSTEMS INC.

4039 21st Ave. W.
Seattle, WA 98199
(206) 285-7266
Table 3
Circle 406

MATRA COMMUNICATIONS INC.

20705 Valley Green Dr.
Cupertino, CA 95014
(408) 446-6701
Table 5A
Circle 407

MEGADATA CORP.

35 Orville Dr.
Bohemia, NY 11716
(516) 589-6800
Table 2
Circle 408

METAPATH INC.

737 Lincoln Centre Dr.
Foster City, CA 94404
(415) 345-7700
Table 3, 4
Circle 409

MICOM SYSTEMS INC.

1400 Los Angeles Ave.
Simi Valley, CA 93063
(805) 583-8600
Table 1
Circle 410

MICOM SYSTEMS INC.

20151 Nordhoff St.
Chatsworth, CA 91311
(213) 998-8844
Table 2
Circle 411

MICROPLEX INC.

1977 State College Blvd.
Anaheim, CA 92806
(714) 634-1535
Table 1
Circle 412

MINNTRONICS CORP.

2599 White Bear Ave.
St. Paul, MN 55109
(212) 770-5247
Table 2
Circle 413

MITEL CORP.

350 Legget Dr.
Kanata, Ontario
K2K-1X3, Canada
(613) 592-2122
Table 5B
Circle 414

MULTI-TECH SYSTEMS INC.

82 Second Ave. S.E.
New Brighton, MN 55112
(612) 631-3550
Table 1, 2
Circle 415

NCR COMTEN INC.

2700 Snelling Ave. N.
St. Paul, MN 55113
(612) 638-7777
Table 1
Circle 416

NEC INFORMATION SYSTEMS INC.

1414 Massachusetts Ave.
Boxborough, MA 01719
(617) 264-8000
Table 3
Circle 417

NATIONAL INSTRUMENTS

12109 Technology Blvd.
Austin, TX 78727
(512) 250-9119
Table 3
Circle 418

NATURAL MICROSYSTEMS

971 Concord St.
Framingham, MA 01701
(617) 875-3821
Table 5B
Circle 419

NESTAR SYSTEMS INC.

2585 E. Bayshore Rd.
Palo Alto, CA 94303
(415) 493-2223
Table 3
Circle 420

NETWORK APPLICATIONS INC.

Great Hills Corporate Ctr.
9020 Capital of Texas Hwy. N.
Austin, TX 78759
(512) 474-2084
Table 4
Circle 421

NETWORK PRODUCTS INC.

P.O. Box 13239
Research Triangle Park, NC
27709
(919) 549-8210
Table 2
Circle 422

NETWORK RESEARCH CORP.

1101 Colorado Ave.
Santa Monica, CA 90401
(213) 394-7200
Table 4
Circle 423

NORTHERN TELECOM INC.

565 Marriott Dr.
Nashville, TN 37210
(615) 885-3510
Table 5A
Circle 424

NORTHERN TELECOM INC.

2100 Lakeside Blvd.
Richardson, TX 75081
(214) 437-8000
Table 3, 4
Circle 425

NORTHERN TELECOM INC. DATA SYSTEMS DIV.

P.O. Box 1222
Minneapolis, MN 55440
(612) 932-8000
Table 3, 4
Circle 426

NOVATION INC.

20409 Prairie St.
Chatsworth, CA 91311
(818) 996-5060
Table 1
Circle 427

NOVELL INC.

1170 Industrial Park Dr.
Orem, UT 84057
(801) 226-8202
Table 3
Circle 428

ORCHID TECHNOLOGY

47790 Westinghouse Dr.
Fremont, CA 94539
(415) 490-8586
Table 3, 4
Circle 429

ORION SOFTWARE INC.

222 Third St.
Cambridge, MA 02142
(617) 576-0470
Table 4
Circle 430

PACER SOFTWARE INC.

1227 Pearl St.
La Jolla, CA 92037
(619) 454-0565
Table 4
Circle 430

PARADYNE CORP.

8550 Ulmerton Rd.
Largo, FL 33540
(813) 530-2000
Table 1, 2
Circle 431

PATHWAY DESIGN

177 Worcester Rd.
Wellesley, MA 02181
(617) 237-7722
Table 4
Circle 432

PENRIL DATACOMM

207 Perry Pkwy.
Gaithersburg, MD 20877-2197
(301) 921-8600
Table 1, 2
Circle 434

POLYMORPHIC SYSTEMS

5330 Debbie Rd.
Santa Barbara, CA 93111
(805) 967-0468
Table 5B
Circle 435

PRENTICE CORP.

266 Caspian Dr.
Sunnyvale, CA 94088-3544
(408) 734-9810
Table 2
Circle 436

PRIME COMPUTER INC.

Prime Park
Natick, MA 01760
(617) 655-8000
Table 3, 4
Circle 437

PROTEON INC.

4 Tech Circle
Natick, MA 01760
(617) 655-3340
Table 3
Circle 438

**RACAL-MILGO
INFORMATION SYSTEMS**

6950 Cypress Rd.
P.O. Box 15662
Plantation, FL 33318
(305) 584-4242
Table 1
Circle 439

How To Triple The Speed Of Your 3270 Printer

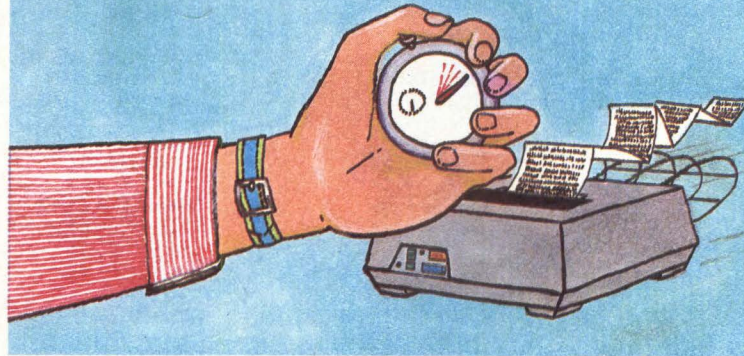

Another Smart Solution From AVATAR

It's a sad sight. Seeing your IBM 3270 printer falling further behind every day. Outpaced by ASCII printers that deliver far greater performance at a much lower cost. ASCII printers that, until now, didn't link to your 3270 system.

Enter AVATAR's PA1500 protocol converter. It lets you attach virtually any ASCII printer directly to your 3270 network with a simple coax connection — including printers that are three times as fast as your IBM printer and cost half as much.

Now you can select the printer that matches your system needs. For greater speed, letter quality printing, better performance. Fast dot matrix or line printers. Bar code or graphics printers. Even the newest ink jet or laser printers can be a part of your 3270 network.

Together, the PA1500 and the printer of your choice give you all the capabilities of your IBM printer...and more.

So get yourself an AVATAR PA1500. And bring your 3270 printer up to speed.

AVATAR

The Link That Thinks

Avatar Technologies Inc.
99 South Street
Hopkinton, MA 01748
(617) 435-6872

Allied Computer Group
(414) 961-8808
Computer Communication Connection
(213) 306-5469
Digital Computer Products
(415) 349-5699
Kaltronics Distributing
(312) 291-1220
Servitronics
(313) 273-0036

International
France/Belgium
ISTA-Imatic
(01) 630 21 46
Sweden
Databolin
(08) 714 00 00

Butler Associates
(617) 964-5270
Data Aids Associates
(713) 353-7728
Epson Great Lakes
(313) 281-2800
Polygon Associates
(314) 576-7709
WA Brown Instruments
(305) 776-4800

Australia/New Zealand
Datatran
(03) 729-2844
Italy
Mactronics
(02) 68 82 141
UK/Ireland
Interlekt Electronics
(0734) 589551

Capital Systems
(703) 892-1150
Data Processing Sciences
(513) 961-0776
Innovative Computer Marketing
(803) 288-2422
Portable Computer Systems
(609) 429-6162
XPOINT
(404) 446-2764

Canada
Ahearn & Soper
(416) 675-3999
Norway
Norwegian Data Comm
(02) 68 89 83
W. Germany/Austria
Stemmer Elektronik
(089) 80 60 61

All product information is subject to change without notice.

© 1984 Avatar Technologies Inc. IBM is a registered trademark of International Business Machines Corporation.

**RACAL-MILGO
INFORMATION SYSTEMS**

1601 N. Harrison Pkwy.
Sunrise, IL 33323
(305) 475-1601
Table 2, 3, 5A
Circle 440

RACAL VADIC

1525 McCarthy Blvd.
Milpitas, CA 95035
(408) 946-2227
Table 1, 2
Circle 441

ROLM CORP.

4900 Old Ironsides Dr.
Santa Clara, CA 95054
(408) 986-1000
Table 5B
Circle 442

**SANTA BARBARA
LABORATORIES INC.**

224 Anacada St.
Santa Barbara, CA 93101
(805) 965-4519
Table 5B
Circle 443

**SANTA CLARA
SYSTEMS INC.**

1860 Hartog Dr.
San Jose, CA 95131
(408) 287-4640
Table 3
Circle 444

SCITEC CORP.

850 Aquidneck Ave.
Middletown, RI 02840
(401) 849-4353
Table 2
Circle 445

SIECOR FIBERLAN

P.O. Box 12726
Research Triangle Park, NC
27709
(919) 554-3791
Table 3
Circle 446

SYDIS INC.

410 E. Plumeria Dr.
San Jose, CA 95134
(408) 945-1100
Table 5A
Circle 447

**SYMPLEX
COMMUNICATIONS CORP.**

2002 Hogback Rd., Suite 17
Ann Arbor, MI 48104
(313) 973-1164
Table 2
Circle 448

SYTEK

1225 Charleston Rd.
Mountain View, CA 94039
(415) 966-7330
Table 3
Circle 449

**TANDY CORP.
/ RADIO SHACK**

1800 One Tandy Ctr.
Ft. Worth, TX 76102
(817) 390-3100
Table 1
Circle 302

**TANGENT
TECHNOLOGIES LTD.**

5720 Peachtree Pkwy.
Suite 100
Norcross, GA 30092
(404) 662-0366
Table 3
Circle 303

**TECH-NEL DATA
PRODUCTS LTD.**

8 Haslemere Way
Banbury, Oxon
OX16 8TY, England
(0295) 65781
Table 1
Circle 304

**TECHNOLOGY
CONCEPTS INC.**

Old Country Rd.
Sudbury, MA 01776
(617) 443-7311
Table 4
Circle 305

TECMAR INC.

6225 Cochran Rd.
Solon, OH 44139
(211) 349-0600
Table 1
Circle 306

TEK-COM CORP.

1887 O'Toole Ave., C103
San Jose, CA 95131
(408) 263-7400
Table 1
Circle 307

**TELEVIDEO
SYSTEMS INC.**

1170 Morse Ave.
Sunnyvale, CA 94086
(408) 745-7760
Table 5A
Circle 308

TELLABS

4951 Indiana Ave.
Lisle, IL 60532
(312) 969-8800
Table 2
Circle 309

TELRAD

510 Broad Hollow Rd.
Melville, NY 11747
(516) 420-1350
Table 5A
Circle 310

TELTONE CORP.

10801 120th Ave. N.E.
Kirkland, WA 98033
(206) 827-9626
Table 2
Circle 311

**TEXAS
INSTRUMENTS INC.**

12501 Research Blvd.
Austin, TX 78759
(713) 895-3113
Table 3, 4
Circle 312

TIMEPLEX INC.

400 Chestnut Ridge Rd.
Woodcliff Lake, NJ 07675
(201) 930-4600
Table 1, 2
Circle 313

**TRANSACTION DATA
SYSTEMS INC.**

5750 Major Blvd.
Orlando, FL 32819
(305) 351-1210
Table 4
Circle 314

TRANSEND CORP.

2190 Paragon Dr.
San Jose, CA 95131
(408) 946-7400
Table 1
Circle 315

TRENDATA CORP.

3400 W. Segerstrom Ave.
Santa Ana, CA 92704
(714) 540-3605
Table 1
Circle 316

TRI-DATA

505 E. Middlefield Rd.
Mountain View, CA 94043
(415) 969-3700
Table 1
Circle 317

UNGERMANN-BASS INC.

2560 Mission College Blvd.
Santa Clara, CA 95050
(408) 496-0111
Table 3
Circle 318

UNISOFT SYSTEMS

739 Allston Way
Berkeley, CA 94710
(415) 644-1230
Table 4
Circle 319

U.S. ROBOTICS

8100 McCormack
Skokie, IL 60076
(312) 982-5010
Table 1
Circle 320

**UNIVERSAL DATA SYSTEMS
/ MOTOROLA-INFORMATION
SYSTEMS GROUP**

5200 Bradford Dr.
Huntsville, AL 35805
(205) 837-8100
Table 1
Circle 321

VEN-TEL INC.

2342 Walsh Ave.
Santa Clara, CA 95051
(408) 727-5721
Table 1
Circle 322

VISIONARY ELECTRONICS

141 Parker Ave.
San Francisco, CA 94118
(415) 751-8811
Table 1
Circle 323

VLSI NETWORKS INC.

2631 Manhattan Beach Blvd.
Redondo Beach, CA 90278
(213) 536-0781
Table 3
Circle 324

VOAD SYSTEMS

12301 Wilshire Blvd.
Suite 101
Los Angeles, CA 90025
(213) 207-8866
Table 5A
Circle 325

WANG LABORATORIES INC.

1 Industrial Ave.
Lowell, MA 01851
(617) 459-5000
Table 1, 3
Circle 326

WESTERN DATACOM

5083 Market St.
Youngstown, OH 44481
(216) 788-6583
Table 2
Circle 327

WESTERN TELEMATIC INC.

2435 S. Anne St.
Santa Ana, CA 92704
(714) 979-0363
Table 2, 3
Circle 328

WILCOM INC.

1009 Mansell Rd.
Roswell, GA 30075
(404) 993-4590
Table 5A
Circle 329

WOLFDATA INC.

187 Billerica Rd.
Chelmsford, MA 01824
(617) 250-1500
Table 1
Circle 330

XYPLEX INC.

100 Domino Dr.
Concord, MA 01742
(617) 371-1400
Table 3
Circle 331

ZAISAN INC.

14511 Falling Creek
Houston, TX 77014
(713) 580-6191
Table 5B
Circle 332

ZTEL INC.

181 Ballardvale St.
Wilmington, MA 01887
(617) 657-8730
Table 3
Circle 333

SUPPLEMENTARY DIRECTORY OF MANUFACTURERS

Information from the following companies involved in communications was solicited but not received.

BLACK BOX CORP.
P.O. Box 12800
Pittsburg, PA 15241
(412) 746-5500

BO-SHERREL CO. INC.
36133 Niles Blvd.
Fremont, CA 94536
(415) 792-0354

**CADMUS
COMPUTER SYSTEMS**
600 Suffolk St.
Lowell, MA 01853
(617) 453-2899

DAVID SYSTEMS INC.
45 Cabot Ave.
Santa Clara, CA 95051
(408) 985-6400

DIGITAL EQUIPMENT CORP.
200 Baker Ave.
Concord, MA 01742
(617) 264-1669

HEWLETT-PACKARD CO.
3000 Hanover St.
Palo Alto, CA 94304
(415) 857-1501

IBM CORP.
900 King St.
Rye Brook, NY 10573
(914) 934-4836

**ROCKWELL INTERNATIONAL
SEMICONDUCTOR/
PRODUCTS DIV.**
P.O. Box C, 4311 Jomboree Rd.
Newport Beach, CA 92660
(714) 978-0262

LOOKING AHEAD IN MMS

MMS's Spring edition of the Peripherals Digest is coming April 19. The issue is divided into product categories containing pricing and specification tables arranged alphabetically by company, and features a staff-written market overview. A directory of manufacturers, keyed to each table is also included. The product categories include:

- 8- and 14-inch disk drives
- ½-inch tape cartridge drives
- graphics terminals
- printers

SPRING PERIPHERALS DIGEST

Mini-Micro Systems

Publishing April 19

Mini-Micro Systems Digests are four desktop reference issues that focus on distinct product categories, and provide comprehensive purchasing information for value-added system builders. The Digests contain regularly updated product data, specification tables, pricing and vendor information that complement the news and features found in our regular monthly issues.

The **SPRING PERIPHERALS DIGEST** provides comprehensive product evaluation, selection and purchasing information, plus staff written market overviews on:

- 8" — 14" Disk Drives
- 8" Flexible Drives
- 1/2" Cartridge Tape Drives
- Graphics Terminals
- Page and Line Printers
- Monitors

...plus a Directory of
Manufacturers

The **SPRING PERIPHERALS DIGEST**, a handy reference source to keep on your desk throughout the year.

For advertising information, call your Regional Sales Manager.

CAREER OPPORTUNITIES/ RECRUITMENT ADVERTISING

More and more advertisers of minicomputers, microcomputers, CRT terminals, printers, disk drives, memories, modems, distributed data processing systems, etc., are consistently turning to **MINI-MICRO SYSTEMS.**

Call Peggy Gordon at 203-328-2550.

System Developers 800-231-5920

Inviting resumes from individuals in the more highly technical computer related vocations such as: PHD Computer Scientists, Operating System Developers, Data Base Developers, Porting Specialists, Networks and Telecommunications, Architecture, Artificial Intelligence, Graphics Systems Developers, Microcoders and Firmware Developers, Compiler Development, etc. Special interest in emerging technology such as novel architecture, UNIX, ADA, etc. Similar interest in scientific applications developers including military, process control, data acquisition, telemetry and communications, CAD/CAM, simulation and modeling, etc.—we are a professional employment firm managed by graduate engineers. Fees are paid by the employer. All geographic locations. Send resume or call D. A. Redwine and ask for our free resume workbook & career planner.



Scientific Placement, Inc.

P.O. Box 19949 CW, Dept. MMS 2 Houston, TX 77224 713/496-6100
UNIX is a trademark of Bell Labs

CIRCLE NO. 240 ON INQUIRY CARD

COMPUTER

Communications NEW DESIGN ★ HIGH VISIBILITY

We have immediate opportunities available with both our Washington, DC and nationally based clients. They are in urgent need of SOFTWARE ENGINEERS/SOFTWARE SYSTEMS ENGINEERS. This is your opportunity to join highly visible teams of professionals involved in design and development of State-of-the-Art in Voice & Data Communications and Software Display. Immediate positions exist for Project Mgrs. and Software and Systems Engineers. We are looking for people with 3+ years experience in Analysis, Simulation & Modeling; The Writing of Software Specifications; Software QA & Software V&V. Particular areas of interest include:

- VOICE & DATA COMMUNICATIONS
- REAL-TIME SOFTWARE DEV.
- OPERATING SYS. & DRIVERS
- SOFTWARE CONFIG. MGMT.
- COMPUTER DESIGN
- TELECOMMUNICATIONS
- TEST SOFTWARE
- SYSTEMS PROGRAMMING

If your experience includes: FORTRAN, ASSEMBLY, STRUCTURED FORTRAN, JOVIAL or UNIX/C and you are interested in investigating these exciting opportunities please send your resume today or call

800-336-3755
in VA call (703) 790-1284

STAFFING CONSULTANTS
8027 Leesburg Pike, Vienna, VA 22180

ALL FEES PAID BY CLIENT COMPANIES

CIRCLE NO. 241 ON INQUIRY CARD

Northern Telecom & New Hampshire ...A Great Career Combination

Northern Telecom Inc. is the largest supplier of fully digital telecommunications systems in the world. Our Network Support Systems Division in Concord, New Hampshire manufactures and markets a large and comprehensive line of telephone test equipment from portable instruments to fully automatic test systems that support and improve network performance.

1985 Career Opportunities

Software Development Engineers — Several opportunities exist in this group, from design through implementation. BSCS or MSCS plus working knowledge of UNIX/C or MACRO 11/RX11M+, or VAX/VMS, and Intel assemblers.

Hardware Design Engineers — Design micro computer based systems and instruments. BSEE, MSEE preferred, plus extensive design experience in telecommunications, digital signal processing, and some software background.

Sustaining Software Engineers — Design and maintain application software for large telephone test system. Will travel occasionally. BSCS, plus 2 years programming experience with C/UNIX or MACRO-11, RSX-11M+.

Components Engineer — Develop component spec's, select and qualify electrical/mechanical components and vendors. BSEE, plus 3 years experience in component related activity. Computer data base generation and management knowledge desired.

Mechanical Engineer (Electronic Packaging) — Design system and instrument packaging using knowledge of EMI/RFI and structural and thermal requirements. BSME, plus 3-5 years experience.

Quality Engineer - Develop environmental testing, systems reliability and EMI testing. Ensure products and test plans comply with commercial specifications. BSEE, plus 3-5 years systems reliability or test engineering experience.

We can offer an excellent salary and a complete benefits program including tuition assistance, company matched savings and stock plans, medical/dental coverage, etc. Please send your resume in confidence to:

Manager, Staffing
Northern Telecom Inc.
Network Support Systems Division
Box 649
Concord, New Hampshire 03301

An equal opportunity employer m/f/h/v



We hire talent

nt northern
telecom

CIRCLE NO. 242 ON INQUIRY CARD

Racal-Milgo

FLORIDA ENVIRONMENTS



THE WORK ENVIRONMENT

Racal-Milgo is one of the largest data communications companies in the world, with a record of nearly three decades of continuous growth.

Our beautiful new 100-acre, Harrison Park headquarters in Ft. Lauderdale offers facilities designed to nurture innovation and initiative. This campus-like complex of low-rise buildings, covered walkways, fountains, lakes and tropical landscaping provides an exceptionally attractive work environment for over 3400 employees.

THE SOFTWARE DEVELOPMENT ENVIRONMENT

Our large, integrated network management systems are preferred by major Fortune 500 companies and governmental agencies. Development tools include VAX™ clusters, CAE workstations, IBM 3083, array processors, LAN, UNIX™ "C," VMS, relational DBMS, on-line simulation/analysis... and more. R&D Software Engineers are involved in a full range of computer science projects, including continuous development of our network management systems. (Our screens are noted for exceptional human interface design.)

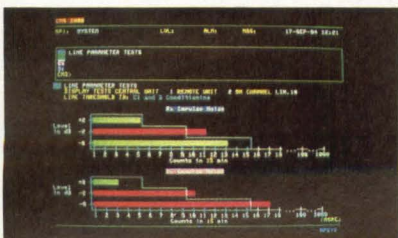

THE SUN ENVIRONMENT

Imagine South Florida: warm sunny days, soft nights. Year-round outdoor recreation. An expanding economy. Favorable tax structure (no state income tax). An influx of high-tech companies. A great place to live and work!



Florida Division of Tourism photo

SOFTWARE ENGINEERS: MULTIPLE OPENINGS AT MULTIPLE LEVELS --

Senior, Principal, Fellow, Manager. Minimum requirements: BSCS/MSCS/PhD with related experience and demonstrated skills within a specialty.

Racal Milgo offers career growth... challenge... continuous learning... participation in decision-making, as well as 3 weeks of paid vacation, 100% paid tuition, and a liberal relocation policy which includes mortgage interest differential.

For an interview, call Rebecca Larsen COLLECT: (305) 748-3507 — or send your resume to:

Engineering Employment

Racal-Milgo®

7800 W. Oakland Park Blvd. (12817)
Ft. Lauderdale, FL 33321

An EEO/Affirmative Action Employer

UNIX is a trademark of Bell Labs.
VAX is a trademark of Digital Equipment Corporation

COMPUTER NETWORKING

The Los Alamos National Laboratory has several challenging career opportunities for Computer Scientists/Engineers in the areas of computer networking.

Responsibilities:

Design and develop network control and data communication software. Specific areas include network gateways, local area networks, high speed packet switching, terminal concentrators, secure communications.

Requirements:

Demonstrated professional experience in computer networking or operating systems. These positions are for individuals who are able to work and communicate effectively in a team effort, require a minimum of supervision, and are highly motivated. B.S. degree in computer science or equivalent education and experience will meet minimum educational requirements.

Benefits:

Competitive salaries and fringe benefits, including 24 days annual vacation; sick leave; paid holidays; medical, dental and retirement programs.

The Los Alamos National Laboratory is located in the mountains of northern New Mexico, at an elevation of 7400 feet. The living is uncrowded, casual, and pollution free. The sunny climate is superb; cool summers and mild winters. Los Alamos has an excellent school system and ample recreational opportunities.

To apply, send resume, in confidence, to:

Tim Merrigan, DIV 85-BN; C-5, MS B255
Los Alamos National Laboratory
Los Alamos, New Mexico 87545

University
of California



AN AFFIRMATIVE ACTION
EQUAL/OPPORTUNITY EMPLOYER
U.S. CITIZENSHIP REQUIRED

CIRCLE NO. 244 ON INQUIRY CARD

SOFTWARE ENGINEERS

Discover a whole new dimension in professional growth at Computer Horizons Corp. Learn why we are among the top 15 software services firms in the country with a client list that includes numerous Fortune 500 leaders. Currently, state-of-the-art projects include development of software modifications to meet specific client applications, as well as developing solutions to client problems relating to software computer design, evaluation and analysis.

If your background includes experience in any of the following areas, we definitely have the opportunity for you.

HARDWARE: DEC, HEWLETT PACKARD, INTEL 8080, IBM PC, TANDEM, DATA GENERAL, HONEYWELL LEVEL 6

SOFTWARE: UNIX*, VAX, RSX, DPL, GRAPHICS, CAD/CAM, DPS, TPS, DEC NET

LANGUAGES: "C", SHELL, KERNAL, PASCAL, FORTRAN, TAL, ANY REAL TIME ASSEMBLERS

COMMUNICATIONS: X.25, SDLC, SNA/NCP, FAULT TOLERANCES

Opportunities exist in our offices in: New Jersey, Delaware, New York, Chicago, Washington, D.C., Virginia, Miami, Orlando, Detroit, Cincinnati, Denver, Houston, San Francisco and Los Angeles.

Our excellent salaries are above industry average with a superior benefits package including health and dental insurance, unlimited tuition refund, relocation assistance and much, much more.

Please call or send your resume to:

Tammy Knauer
National Recruiting Director
In New York Call (212) 371-9600
Outside of New York Call (800) 847-4097

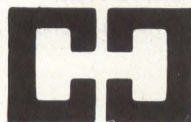

**COMPUTER
HORIZONS CORP.**

747 Third Avenue, Department MM1 - 2
New York, N.Y. 10017

An Equal Opportunity Employer M/F
* UNIX is a trademark product of Bell Labs

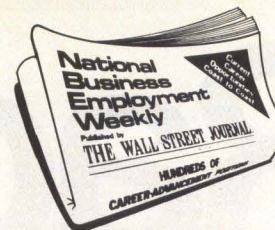

**Which one of our
computer-related
positions is right
for you?**

Find out in the
National Business Employment Weekly.

Every week, the National Business Employment Weekly, published by The Wall Street Journal, contains hundreds of the best executive, managerial and professional positions from all across the country. Top jobs in every field, including career opportunities in virtually every area of computer technology. At salaries from \$25,000 to \$250,000.

PLUS... weekly editorial features covering every aspect of career advancement. Articles on writing resumes, interviewing, salary statistics, regional employment trends, and much more.

**LOOK FOR OUR SPECIAL FEBRUARY 24TH
"EDP & COMPUTER ENGINEERING" ISSUE
WHICH WILL INCLUDE ADDITIONAL CAREER
OPPORTUNITIES IN THE COMPUTER INDUSTRY
AND RELATED EDITORIAL.**

Pick up a copy of the National Business Employment Weekly at your newsstand today. Or we'll send you the next eight issues by first class mail. Just send a check for \$32 to:
**National Business Employment Weekly,
Dept. E, 420 Lexington Avenue,
New York, NY 10170.**

CIRCLE NO. 241 ON INQUIRY CARD

ENGINEERS

Choice positions available in New England and Nationwide. If you earn \$25,000 or more we have a more rewarding job for you.

**Networking • Communications
ATE Engineers • Tools & Utilities SW
Real-Time SW • Memory Design**

All fees & expenses paid. Call or send resume to:

LARSEN PERSONNEL
1492 Highland Avenue
Needham, MA 02192
(617) 449-3840

Serving the high tech industries.

Hardware design engineer. Micro-processor-based controller design for electrical power plant applications, involving power electronics, hardware and software design. Requires MSEE. 40 hrs per week, \$23K per yr. Apply: **KS Job Service, 552 State Ave., K.C., KS 66107. Refer to J0748786.**

Peggy Gordon

Recruitment Manager

(203) 328-2550

Call your ad in—
we'll set the type
at no charge.

TEST SYSTEMS DESIGN & DEVELOPMENT

Test third generation gyro accuracy in TGII Test Stations as you advance within Northrop Electronics Division.

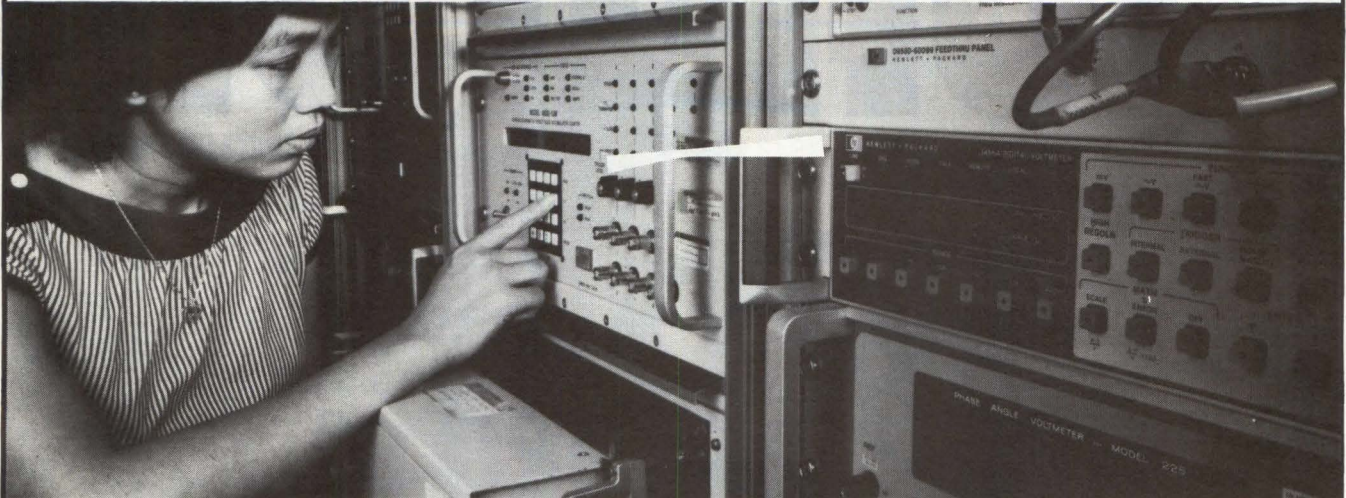

One-of-a-kind technologies are within your reach.

ATE Development Engineer

Design, analyze and develop automatic test equipment (ATE) for testing of electronic subsystems for avionic, inertial navigation and radar systems. Requires ATE background and 3 years' experience in aerospace systems. BSEE or equivalent required.

ATE Software Development Engineer

Develop software for control of ATE. Analyze requirements and develop design descriptions, functional flow charts and module subroutine allocations, code and integrate. Requires experience with HP200 series computer and working knowledge of PASCAL and FORTRAN; experience with HP Data Acquisition Control Unit 3497 desired. BSEE required.

ATE Specifications Engineer

Develop specifications for ATE hardware and software in accordance with MIL-STD's 490 & 483. Requires knowledge of ATLAS and experience with ATE or test program sets. MIL-STD 490/483 background preferred. BSEE required.

Firmware Development Engineer

Develop firmware for microprocessor-controlled test equipment. Requires 3+ years experience in firmware or real-time program applications. BSEE or BSCS required.

MATE Software Engineer

Design and develop Automatic Test Systems using the MATE philosophy. Requires background in Assembly and High Order Languages (JOVIAL J73). Experience with UNIX operating systems, VAX 11/780 and MIL-STD-1750A computers desirable.

Microprocessor Programming Engineer

Design and program microprocessor-controlled test equipment. Develop and debug software for 8086 microprocessor. Design and test digital hardware. Write design specifications, test procedures and manuals. Requires experience in electronic design and microprocessor programming; familiarity with MIL environment test equipment requirements preferred. BSEE required.

Metrology Engineer

Assume lead role in development and integration of a mobile automatic calibration system for depot ATE. Defines calibration requirements, selects standards and develops procedures. Assist in the development & implementation of ATE calibration software. BSEE and at least 7 years' experience required.

Test Equipment Systems Engineer

Responsible for systems analyses, concept definitions, trade studies, system architectural designs, interface control documents, test equipment specifications, and system integration plans and procedures for systems test equipment. Will perform hardware/software tradeoffs and configure new test systems. Test equipment background and BSEE or BSCS required.

Analog Design Engineer

To work on manual power supply test equipment. Positions exist at all levels of experience for degreed engineers with avionics or analog circuitry design background. BSEE preferred.

Test Program Set Development Engineer

Develop automated test program sets for avionics electronic subsystems, analyze test requirements, design adapter electronics, and develop and integrate ATLAS software. Requires 4 years' experience in electronic design and software development and knowledge of test equipment and ATLAS language. Experience with HP1000 system preferred plus BSEE, or equivalent, required.

Research Engineer/ ATE Systems

Assume duties of a Senior Technical Staff Engineer in the area of Test Systems (ATE) serving as technical troubleshooter for senior management and providing the technical direction to other engineers in order to complete a project on schedule and within cost. Experience must include MTE/ATE detailed circuit design plus functional circuit analysis on complicated analog and digital system and subsystem units for test. Recent background required in the development of ATE station with multiple/compatible instruments controlled by HP 1000 or TEK 3260/3270 in BASIC or ATLAS. MSEE preferred.

ATE Systems Software Engineers

Design, code and integrate software modules relating to ATLAS compiler and test station operation system for automated test systems, working from new ATS requirements or change requests. Requires experience with HP 1000 automated test systems, HP RTE IVB, HPID and HP device subroutines, related software and ATLAS compilers. Fluent knowledge of FORTRAN IV required. BSEE, BSCS, MS/Math or equivalent experience required.

Please send your resume to: **John Cinege, Northrop Electronics Division, Professional Employment N1, Dept. MM 18115, 2301 W. 120th Street, Hawthorne, CA 90250.**

Proof of U.S. Citizenship Required. Northrop is an Equal Opportunity Employer M/F/H/V.

We're within your reach.

NORTHROP

Electronics Division
Electronics Systems Group

CIRCLE NO. 245 ON INQUIRY CARD

QUANTUM

CORPORATION

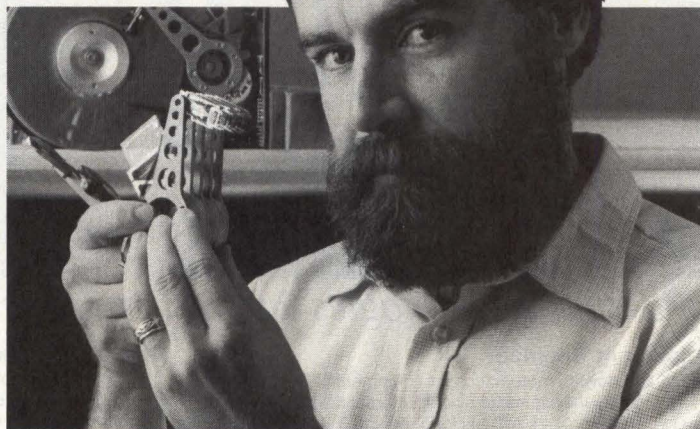

To Craft Quality Products, We Hire Quality People

Since Quantum Corporation began, we've made no secret about our formula for success—to provide innovative, high performance fixed disk drives of outstanding quality at the lowest possible cost.

The key to that formula is quality. Because no matter how cleverly a product is designed, or how little it costs, it's useless unless it performs consistently and reliably. And the key to quality is to have everyone dedicate themselves to that principle.

That's why Quantum hires only those individuals who demonstrate, through their experience and enthusiasm, that they share our commitment to quality. Since such people are, by their nature, rare, we reward them with excellent incomes, comprehensive benefits, advanced equipment, and modern facilities.

Listed below are some of our current openings:

- Mechanical Design Engineers
- Electrical Design Engineers
- Controller Design Engineers
- Production Engineers
- Magnetic Recording Head/Disk Engineers

If you share our dedication to quality, and you have a background in any of the areas mentioned above, then you belong at Quantum. Send your résumé to QUANTUM Corporation, Human Resources, 1804 McCarthy Boulevard, Dept. MMS, Milpitas, CA 95035. We are an equal opportunity employer, m/f/h/v.

CHOOSE QUALITY CHOOSE QUANTUM

CIRCLE NO. 246 ON INQUIRY CARD

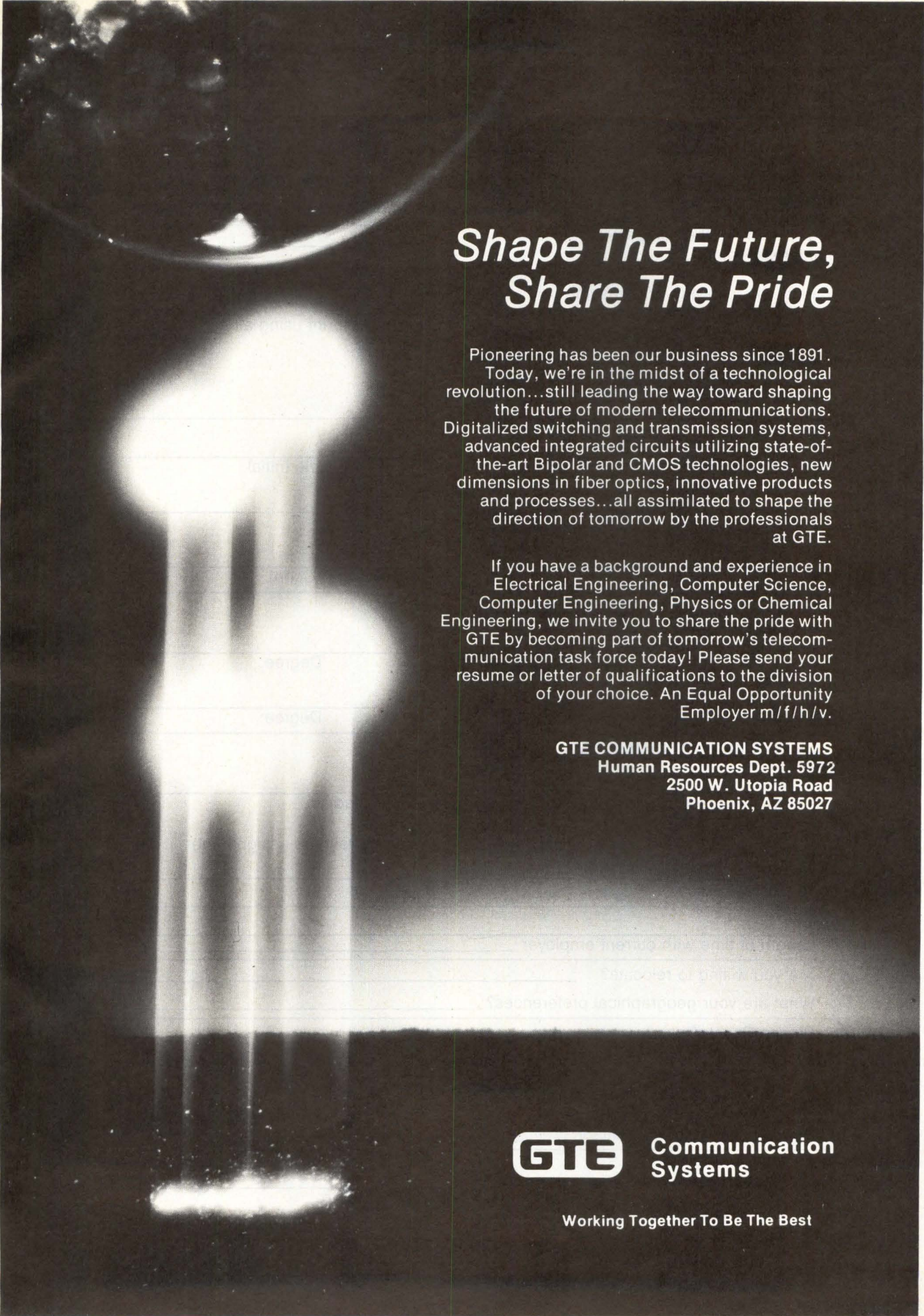

Shape The Future, Share The Pride

Pioneering has been our business since 1891. Today, we're in the midst of a technological revolution...still leading the way toward shaping the future of modern telecommunications. Digitalized switching and transmission systems, advanced integrated circuits utilizing state-of-the-art Bipolar and CMOS technologies, new dimensions in fiber optics, innovative products and processes...all assimilated to shape the direction of tomorrow by the professionals at GTE.

If you have a background and experience in Electrical Engineering, Computer Science, Computer Engineering, Physics or Chemical Engineering, we invite you to share the pride with GTE by becoming part of tomorrow's telecommunication task force today! Please send your resume or letter of qualifications to the division of your choice. An Equal Opportunity Employer m/f/h/v.

GTE COMMUNICATION SYSTEMS
Human Resources Dept. 5972
2500 W. Utopia Road
Phoenix, AZ 85027



**Communication
Systems**

Working Together To Be The Best

CIRCLE NO. 247 ON INQUIRY CARD

CAREER OPPORTUNITIES/ RECRUITMENT ADVERTISING

RESUME FORWARDING SERVICE

To have your resume forwarded on to the company of your choice, simply write in the box at the right the name of the company that interests you.

Forward my brief resume to:

(Never more than 3 companies, please)

Complete the following brief resume and mail to: Peggy Gordon

MINI-MICRO SYSTEMS
P.O. Box 10277
8 Stamford Forum
Stamford, CT 06904

(Please type, or print using all caps in dark ink.)

1.

Last Name _____ First _____ Middle Initial _____

Home Address (Street, City, State, Zip) _____

Home Phone (Area Code) _____ Other (Area Code) _____

2. *EDUCATION INFORMATION: Schools Attended*

Name _____ Location: _____ Degree: _____

Name _____ Location: _____ Degree: _____

3. *EMPLOYMENT INFORMATION:*

Name & Address of Present Employer (Will not be contacted) _____

Position (Please give brief description of your title and current job assignment)

Length of time with current employer _____

4. Are you willing to relocate? _____

What are your geographical preferences? _____

5. Please Check One:

U.S. Citizen _____ Permanent Resident _____ Student Visa _____

6. Foreign Language

Read _____ Write _____ Speak _____

7. Please indicate current salary _____

*Please Sign Here

Date

*Your signature will authorize us to forward the above information on to the company of your choice, in the strictest confidence. Your current employer will not be contacted.

THE COMPATIBILITY[®] BOX

is a family of

complementary data communication modules. One of the most successful members of this family is the P.I.T., Programmable Interface Translator.

THE MOST COMPLETE RS232C INTERFACE PROBLEM SOLVER

The P.I.T. is a black box type converter for RS232C/V24 based interfaces and is able to cope not only with asynchronous transmission differences such as handshakes, code/string conversion, and all sorts of transmission parameters, but also with synchronous protocols: IBM BSC 2780/3780, 3270, 3741, SIEMENS MSV1/MSV2 and BURROUGHS poll/select.

The programming principle is unique: The micro system inside the box runs a program covering the stated possibilities. In PROGRAM mode, selected by the only switch on the box, the user may configure the P.I.T. in the field using a temporarily connected dumb terminal. The set-up parameters will not be lost after power-off. The unit can be reconfigured at any time (so extremely useful for overcoming unforeseen difficulties on site). When the switch is set to RUN, the P.I.T. is ready to do the job.

A FULL RANGE OF PROTOCOL CONVERTERS IN ONLY ONE BOX

MORE THAN JUST A PROTOCOL CONVERTER. The emulation of a 3278 terminal or a 3287 printer is often called protocol conversion. The P.I.T. can do much more: Batch (RJE) as well as 3270; file transfer as well as interactive, but also just async to async. In addition to acting as a tributary station, the P.I.T. can also emulate a (3705) front end processor at one or both ports. Functions such as code counting, word wrap, timer, data diversion, and many others may be selected meaning that one and the same model is able to cover an endless range of applications allowing greater flexibility and the minimization of stock and spares.

The unit is complete with built-in power supply and extensive user's guide.

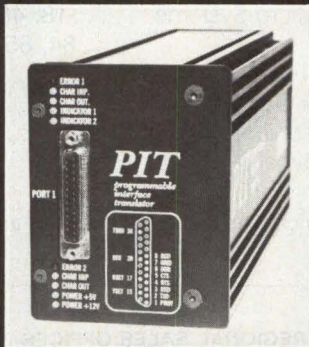

MORE THAN 2000 UNITS HAVE ALREADY BEEN INSTALLED THROUGHOUT EUROPE.



EXTENSION OF YOUR MAINFRAME WITH ALMOST ANY PERIPHERAL



EMULATION OF A 3278 DISPLAY STATION

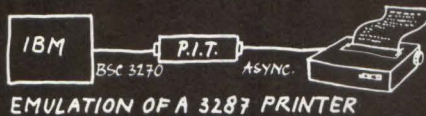

EMULATION OF A 3287 PRINTER



INTERFACING COMPUTERS OF DIFFERENT MAKES

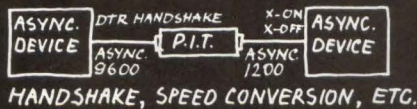

HANDSHAKE, SPEED CONVERSION, ETC.

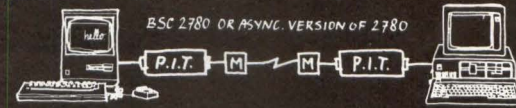

PROTOCOL SECURED COMMUNICATION

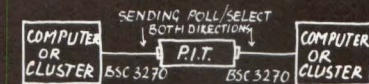

INTERFACING TWO 3274 TYPE DEVICES BY EMULATING A COMM. CONTROLLER AT BOTH SIDES

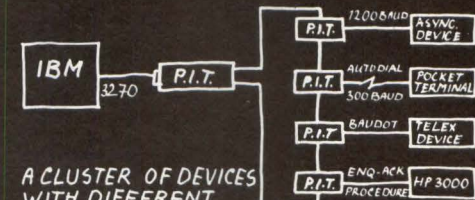

A CLUSTER OF DEVICES WITH DIFFERENT CODE AND/OR TRANSMISSION CHARACTERISTICS

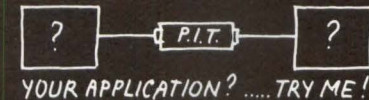

YOUR APPLICATION? TRY ME!

INCAA
COMPUTERS

INCAA B.V. P.O. Box 211, 7300 AE Apeldoorn - Holland. Tel. 055-551262. TLX 49632

Price 100+ quantity
US \$ 495 (F.O.B.)

We are primarily interested in companies willing to enter into an OEM or Distributor agreement. Would those interested please respond directly to us by letter or telex.

Authorized distributors:
Austria Gebrueder Schoeller Vienna 0222-842 631
Belgium Telindus S.A. Brussels 02-648 4470
Finland Symmetric Oy Helsinki 0-90 585 322

Gr. Britain INCAA Branch Off. Bedford 0234-781 300
Italy INCAA s.r.l. Varese 0332-310 231
Sweden Data Distribution AB Alvsjo 08-749 1575
Switzerland Interep SA Geneva 022-431 150

ADVERTISERS INDEX

Ampex Corp., Computer Products Div.	86-87	Equinox Systems	42	Quadram Corp.	98
Avatar Technology	109, 111	Fujitsu America Inc.	19	Qume (a subsidiary of I.T.T.)	62
Bytcom	20	Gamma Technology	18	Rodime	6
Cambridge Digital Systems (Div. of Compumart)	C3	Gandalf Data Inc.	47	Systems Strategies Inc.	2
Case	22-23	Gateway Communications	66-67	Tangent Technologies	61
Cermetek Microelectronics	15	Incaa Computers	121	Telenetics	10
ComDesign	38	Intercontinental Micro	58	Televideo Terminals	88
Concord Data Systems	12	Lear Siegler Inc.	103	Ungermann-Bass	8-9
CTS Corp. - Datacomm Products	4, 21	MDB Systems Inc.	45	Viking Acoustical	64
CXI	C2-1	Method Systems Inc.	85	Wyse Technology	78-79
Davong Systems	5	Micom Systems Inc.	C4		
Dilog (Distributed Logic Corp.)	48-49	Mini-Micro Systems	18, 46, 64, 84, 85, 113		
Emulex Corp.	72-73	Multi-Tech	24	See p. 114-120 for Career Opportunities Advertisers	
		Novell Data Systems	65	See p. 123-124 for Mini-Micro Marketplace	
		Panasonic Industrial Co.	46		
		Paradyne	16		

This index is provided as an additional service. The publisher does not assume any liability for errors or omissions.

REGIONAL SALES OFFICES

BOSTON

Robert K. Singer
National Sales Manager
Norma E. Lindahl
Assistant To The National Sales Manager

John J. Fahey
Regional Manager
Katie Kress
Sales Coordinator
221 Columbus Ave.
Boston, MA 02116
(617) 536-7780

PHILADELPHIA

Stephen B. Donohue
Regional Manager
1873 Route 70, Suite 302
Cherry Hill, NJ 08003
(609) 751-0170

ATLANTA

Larry Pullman
Regional Manager
6540 Powers Ferry Rd.,
Suite 170
Atlanta, GA 30339
(404) 955-6500

CHICAGO

Robert D. Wentz
Regional Manager
Marianne Majerus
Sales Coordinator
Cahners Plaza
1350 E. Touhy Ave.
P.O. Box 5080
Des Plaines, IL 60018
(312) 635-8800

DALLAS

Don Ward, Regional Manager
13740 Midway Suite 515
Dallas, TX 75234
(214) 980-0318

DENVER

John Huff
Regional Manager
270 St. Paul St.
Denver, CO 80206
(303) 388-4511

LOS ANGELES

Len Ganz
Regional Manager
12233 West Olympic Blvd.
Suite 236
Los Angeles, CA 90064
(213) 826-5818

ORANGE COUNTY

Debra Huisken
Regional Manager
2041 Business Center Dr.
Suite 109
Irvine, CA 92715
(714) 851-9422

SAN FRANCISCO

Frank Barbagallo
Northwestern Region Sales Manager
Rick Jamison
Regional Manager
Janet Ryan
Regional Manager
Kathleen Maxwell
Sales Coordinator
Sherman Building, Suite 100
3031 Tisch Way
San Jose, CA 95128
(408) 243-8838

AUSTRIA

Elan Marketing Group
Neutor g. 2
P.O. Box 84
1010 Vienna, Austria
Tel: 43-222-663012 or -638461

BENELUX

Elan Marketing Group
Boschdijk 199B
5612 HB Eindhoven
The Netherlands
Tel: 32-40-455724

ISRAEL

Elan Marketing Group
13 Haifa St., P.O. Box 33439
Tel Aviv, Israel
Tel: 972-3-252967 or -268020
Telex: 341667

JAPAN

Tomoyuki Inatsuki
General Manager
Trade Media Japan Inc.
R. 212 Azabu Heights
1-5-10 Roppongi Minato-ku,
106, Japan
Tel: (03) 587-0581

TAIWAN

Mr. Donald H. Shapiro
Trade Winds, 2nd Floor
132 Hsin Yi Road, Sec. 2
Taipei, Taiwan

UNITED KINGDOM

Elan Marketing Group
5th Floor, Suite 10
Chesham House
136 Regent St.
London W1R 5FA
Tel: 437-6900
Telex: 267653

SWEDEN

Elan Marketing Group
Humlegardsgatan Nr. 5
11446 Stockholm, Sweden
Tel: 46-8-677243 or -676243

WEST GERMANY

Elan Marketing Group
Sudring 53
7240 Norb/Neckar, West Germany
Tel: 49-7451-7828

Mini-Micro Marketplace

Norma Lindahl
221 Columbus Ave.
Boston, MA 02116
(617) 536-7780

Direct-Response Postcards

Carol Flanagan
221 Columbus Ave.
Boston, MA 02116
(617) 536-7780

Career Opportunities

Peggy Gordon
Recruitment Advertising Manager
P.O. Box 10277
8 Stamford Forum
Stamford, CT 06904
(203) 328-2550

Cahners Magazine Division

J.A. Sheehan, President
William Platt
Executive Vice President
T.M. McDermott, Vice President
Electronics/Computer Group
Tom Dellamaria, VP/Production
Ira Siegel, VP/Research

Promotion Staff

Susan Rapaport
Marketing Communications Director
Mary Gregory
Promotion Manager
Liz Phillips
Promotion Assistant

Circulation

Denver, CO:
(303) 388-4511
Sherri Gronli
Group Manager

This year Mini-Micro Systems readers will spend almost \$50 billion on Minicomputers and Microcomputers*

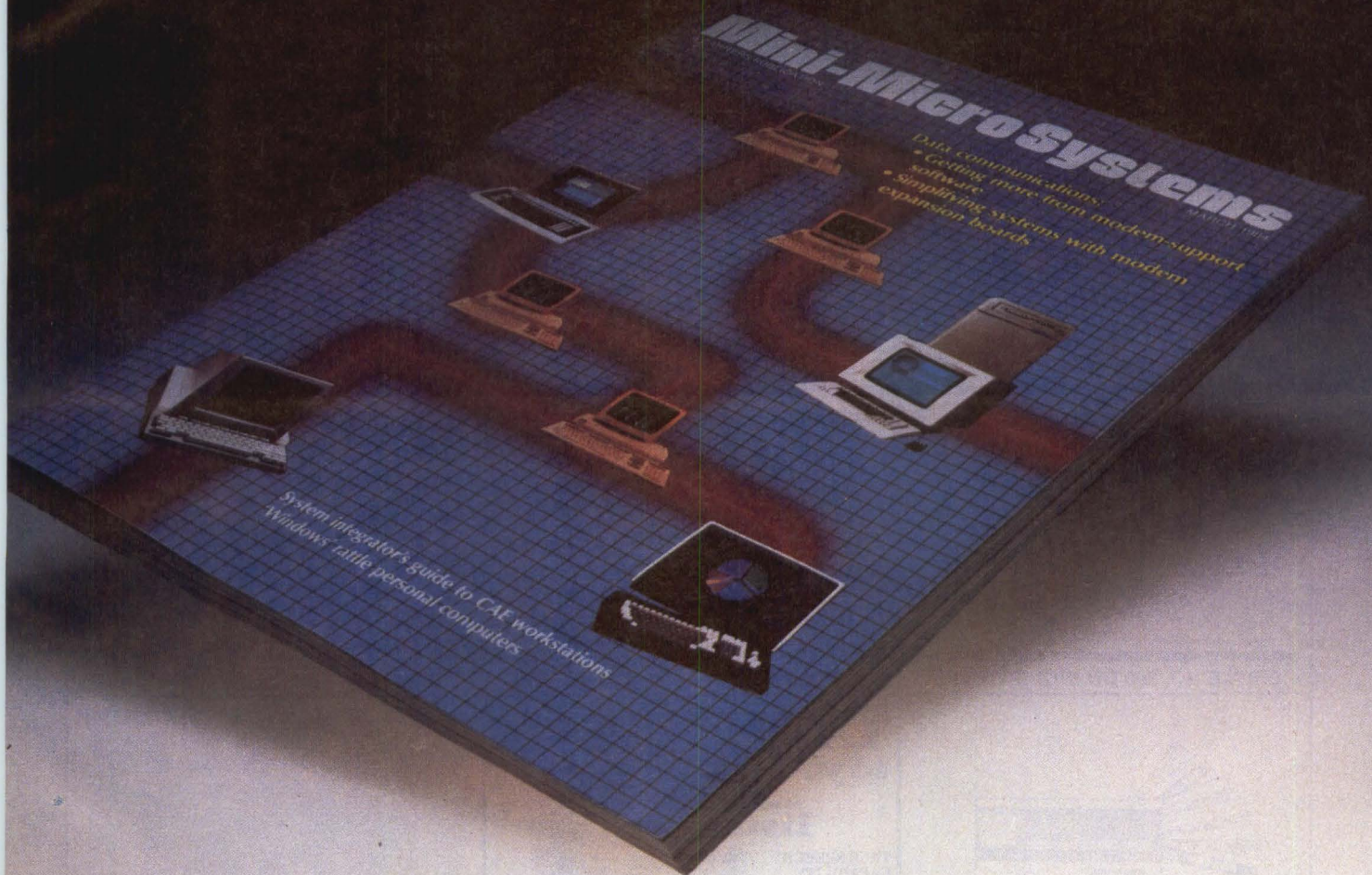

Mini-Micro Systems is the only advertising vehicle to reach the *complete* value-added market for mini-micro computers, peripherals, software, data communication products, supplies and services.

Who are these key prospects? Over 130,000 systems integrators, value-added OEMs, value-added resellers, and value-added users who purchase hardware and software products to configure mini-micro computer systems.

For more information on our market and our magazine, call or write Mini-Micro Systems, 221 Columbus Avenue, Boston, MA 02116 (617) 536-7780.

Mini-Micro Systems

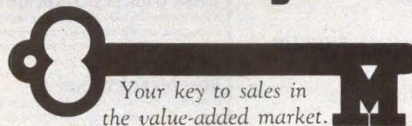

MINI-MICRO SYSTEMS: 221 Columbus Ave., Boston, MA 02116 (617) 536-7780/Chicago: (312) 635-8800/Dallas: (214) 980-0318/ Denver: (303)388-4511/Los Angeles: (213)826-5818/Mid-Atlantic: (609)751-0170/Orange County: (714)851-9422/Northern California & Northwest: (408)243-8838/Southeast: (404)955-6500

Cahners Publishing Publishers of 32 specialized business magazines in Building & Construction Electronics & Computers Foodservice Manufacturing Medical/Health Care

Based on the 13th Annual Mini-Micro Computer Market Report

MINI-MICRO MARKETPLACE

A special section for advertisers of hardware, software and services.

Please circle reader service numbers for additional information.

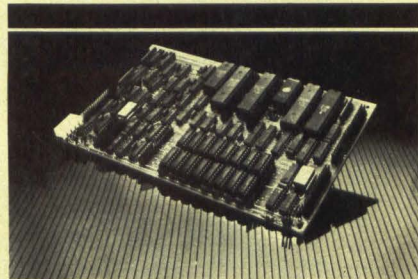

POWER THAT GOES ANYWHERE!

Single Board Computer

- FAST** — 6MHz Z80B* CPU
- POWERFUL** — 64K to 256K RAM, 2K to 64K ROM
- 5 1/4" and 8" Floppy Controller, SASI
- 2 RS-232, Centronics Port
- FLEXIBLE** — 50-pin I/O Expansion Bus.
- SMALL** — 5 1/2" x 10"

Davidige

DAVIDIGE CORPORATION
292 East Highway 246
P.O. Box 1859
Buellton, CA 93427

(805) 688-9598

*Z80 is a registered trademark of Zilog

CIRCLE NO. 200 ON INQUIRY CARD

ENCLOSURE PRODUCTS

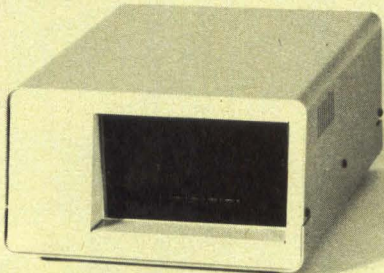

- Floppy and Hard Disk Drive Enclosures for all Major Micros.
- Xebec Controllers Optional
- Custom Design Available
- Class 'B' Certification Support Can Be Provided
- Call For Pricing and Catalog

Microware, Inc.

41711 Joy Road • Canton, MI 48187
(313) 459-3557

CIRCLE NO. 201 ON INQUIRY CARD

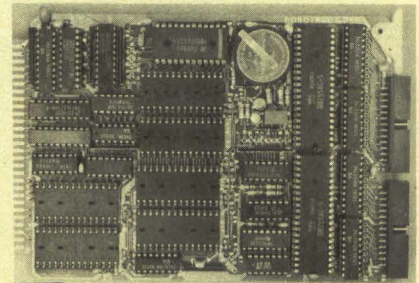

STD CLOCK, MEMORY, I/O BOARD. The RSD-7758 features a battery backed 14 digit real time clock w/prog. interrupt, six 28 pin bytewise memory sockets, 48 buffered parallel I/O lines. Available options: up to 48K bytes battery backed RAM and 32 high current open collector drivers for parallel I/O. Board is memory mapped and decodes either 16, 17 or 20 address lines. Consult factory for other available configurations. ROBOTROL CORP., 16100 Caputo Drive, Morgan Hill, CA 95037. (408) 778-0400.

CIRCLE NO. 202 ON INQUIRY CARD

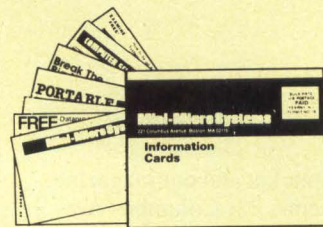

**HIGH INQUIRIES
LOW COST**

- Sell products and services directly
- Introduce new products
- Investigate new applications
- Develop new sales leads

**MINI-MICRO SYSTEMS
DIRECT RESPONSE POSTCARDS**

CIRCLE NO. 203 ON INQUIRY CARD

TALK BACK to your PC ...and listen

**TRUE SPEECH
CAPABILITY
FOR THE IBM PC!**

The DIALOG Voice System digitizes speech in real time, stores it on disk, and plays it back on command. Each board comes complete with the software drivers to hook our hardware to the applications program of your choice.

WHAT WILL IT DO FOR ME?

Applications include verbal annotation of text, electronic mail and messaging, intelligent phone management, telemarketing, and remote data entry. Dialogic provides the optimum speech I/O "engine" for the IBM PC world.

HOW DO I GET ONE?

DIALOG/1, the basic model, is priced at \$295. DIALOG/2, with an intelligent phone interface and touch-tone decoding, is \$495. DIALOG/3, with modem, is \$595. Each board comes with a detailed user's manual, diskette, with the software drivers, and demo package.

Call or write us for detailed specs.
Toll-free at 800 221-0383, or direct at 201 386-0202.
DIALOGIC CORPORATION/164 McKinley Avenue
East Hanover, NJ 07936

Talk back. With DIALOGIC.

CIRCLE NO. 204 ON INQUIRY CARD

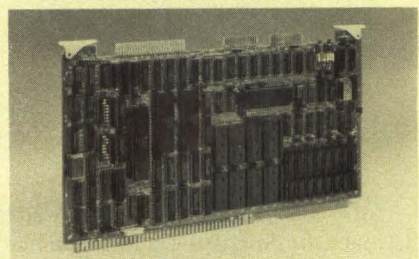

10 MHz Z8000™ PERFORMANCE

In addition to 10 MHz, the NEW MBx8000 SBC features a single width SBX connector for adding standard expansion modules, such as the SBSxFDC Floppy Controller. MBx8000 maintains all the capabilities of its predecessor, the MB8000: Z8001/Z8002 CPU 4/6/10 MHz; 32K/128K/512K DRAM; up to 48K static RAM or EEPROM; up to 128K EPROM; 2 RS-232 ports; 40 parallel I/O lines; six 16-bit counter-timers; etc. Z8000™ Zilog. SINGLE BOARD SOLUTIONS, 7669 Rainbow Drive, Cupertino, CA 95104. (408) 253-0181

CIRCLE NO. 205 ON INQUIRY CARD

To Advertise: Call Norma Lindahl 617-536-7780

MINI-MICRO SYSTEMS

Get the VAX[®] Performance DEC[®] Dreams About.

Fortunately, you don't have to dream. Because the VAX performance you demand is shipping now from Cambridge Digital. You get the quality and dependability of a VAX processor, enhanced with state of the art components from recognized leaders like National Semiconductor, Fujitsu, Cipher, and Emulex. For the entire VAX line, you get performance simply not available from DEC. Each system is assembled and tested, then loaded with your choice of VMS, UNIX System/V or Berkeley UNIX 4.2 operating systems and applications. DEC maintenance is available. Call TOLL FREE for a price on your dream configuration.



**FREE
CATALOG**

800-343-5504

In Mass: 617-491-2700

In NY: 516-935-3111

CIRCLE NO. 44 ON INQUIRY CARD

* UNIX is a trademark of AT&T Technologies, Inc.

* DEC, VAX, VMS are trademarks of Digital Equipment Corporation.

digital VAX 11/750

**Cambridge
Digital**

DIVISION OF COMPUMART

The Edge in Value-Added DEC[®] Systems

Dept. 7401, P.O. Box 568, 65 Bent St., Cambridge, MA 02139

Telex: 92-1401/COMPUMART CAM

Why should you care that we became the big name in the little end of the concentrator business?

One reason you might care is that we got there by building a family of data concentrators which saved you money and solved your data communications problems:

Micro800/2 Data Concentrators

The world's most popular line of data concentrators. Specifically designed for the user of minicomputers and "dumb" asynchronous terminals, they can pay for themselves in a few months by supporting many remote terminals on one telephone line, while also providing Automatic Retransmission on Error, Satellite Capability, Synchronous Channel Support, a Command Port, and much more. . .

Micro900/2 Multidrop Concentrators

Bringing the benefits of MICOM's data concentration to users whose terminals are widely scattered, so that "dumb" terminals in up to 16 different locations can share a single telephone line.

Micro800/2HP Data Concentrators

Specially designed to handle the unique requirements of HP 3000 systems employing HP's ENQ/ACK protocol.

Another reason you might care is that now we can solve your next data communications problems too, with new family members such as:

Micro860 Concentrator Switches

Brand new kinds of products which bring add-on switching, contention, queueing, and centralized management to networks of up to eight data concentrators.

Micro800/X.25 Concentrator PADs

Products which combine the benefits of Micro800/2 Data Concentrators with CCITT X.25-compatible packet assembly to allow asynchronous terminals and computer ports to access public or private Packet Data Networks easily and inexpensively.

And still another reason is that concentrators are only one family of MICOM products. Now we can be the only source you need for minicomputer data communications products from modems to data PABXs to local networks. Thanks to you, we're big in those fields too!



**Concentrate.
Because it's
much cheaper!**

OVER 100,000 SHIPPED!

MICOM®

MICOM Systems, Inc. • 20151 Nordhoff Street • Chatsworth, CA 91311 • Telephone (805) 583-8600 • TWX 910/494-4910
Regional Sales/Service • Atlanta, GA • (404) 435-2999 • Boston, MA • (617) 527-4010 • Chicago, IL • (312) 964-0551
Dallas, TX • (214) 258-0774 • San Francisco • (415) 327-0890 • St. Louis, MO • (314) 576-7626 • Teaneck, NJ • (201) 836-4000
MICOM-Borer Ltd. • Reading RG20JT, England • (0734) 866801 • MICOM Europe • Newbury RG13JU, England • (0635) 832441

For literature please call: (800) "MICOM U.S."

CIRCLE NO. 45 ON INQUIRY CARD

M4003