

Mini-Micro Systems

A CAHNERS PUBLICATION

JUNE 1985

State-of-the-Market Report

- Personal computers
- LANs
- Tape drives
- Value-added resellers

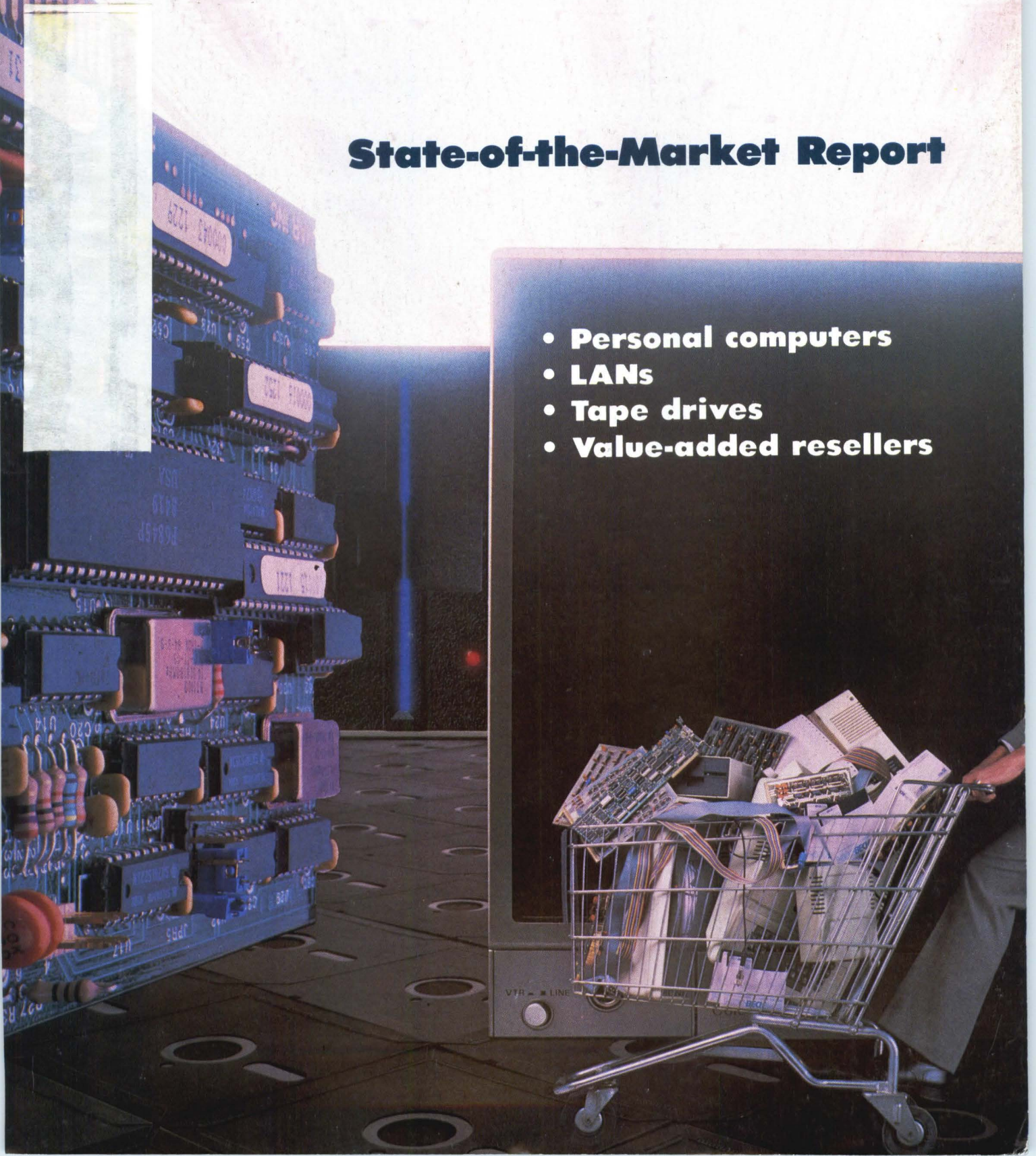

THE POWER OF PORTABILITY.

Now—in the time it takes you to read this message, this BASIC interpreter from Control-C Software can port a Business BASIC program to any microcomputer operating system—including UNIX,[™] MS-DOS[™] and CP/M.[™] That's only one reason why CCS Business BASIC already provides solutions at 90,000 micro sites.

Whether you're an application developer, computer OEM or integrator, CCS Business BASIC can instantly enrich your software catalog with high-demand libraries of proven programs. And your new Business BASIC programs will port to the same environments just as quickly.

**CIRCLE NO. 1
ON INQUIRY CARD**

CCS Business BASIC also makes new programming easier—for faster market entry, and its hardware/operating system independence protects your programs from costly future updates. Written in high-level "C," CCS Business BASIC provides transparent and concurrent multi-user file-handling, plus local-area networking capabilities.

Call or write Control-C Software for your 30-day free examination. Get your hands on its powerful portability—right now.



Control-C Software, Inc.

6441 S.W. Canyon Court
Portland, Oregon 97221
(503) 292-8842
TELEX: 151215
JLICCS PTL



CCS BUSINESS BASIC

CCS BUSINESS

INGENIOUSLY

NEW!

INCREDIBLY

700 cps for under \$2000.

FAST!

Now you can move mountains of data without paying a premium for a high speed printer. The new OT-700 matrix printer, priced amazingly low at under \$2000, prints at an incredible 700 characters per second. Effortlessly. The secret behind this speed breakthrough is a unique "shared resource" Tri-Head print technique.

A technique that delivers high throughput with minimal effort for high reliability, for around-the-clock trouble-free performance.

There's more. Dual pass correspondence printing at 350 cps. Two graphics modes. Front panel menu programming. Condensed or expanded print. Serial/parallel interface ports. And it's made in the U.S.A. Call or write for more information.



Distributed by:

CA Western Micro Syst. (415) 964-2050; Argus (818) 846-1545; Gemini (714) 891-1507
Western Micro Syst. (818) 700-9922 FL Input Syst. Assoc. (305) 724-4321
HI MegaByte (808) 944-0462 IL Kaltronics (312) 291-1220 MA Eastern Micro (617) 480-0400
MI MCD Corp. (313) 924-1020 MN Kaltronics (612) 544-0494 NJ Gen. Business (609) 424-6500
NY Rudor (212) 582-7315 R.G. Eng. (714) 424-7492 OH Swenson (513) 866-3233
R.G. Eng. (216) 292-6242 OR Western Micro Syst. (503) 635-1340 PA R.G. Eng. (412) 443-7670
TX M-P Syst. (214) 385-8885 UT Computer Ware (801) 534-0337
WA Western Micro Syst. (206) 881-6737 CANADA Peripherals Plus (514) 281-1306

Nationwide Service by **NCR**

See us at NCC, Booth #4009

OTC OUTPUT
TECHNOLOGY
CORPORATION

E. 9922 Montgomery
Spokane, WA 99206
(509) 926-3855 800-4-OUTPUT

CIRCLE NO. 2 ON INQUIRY CARD



State-of-the-market report. Design and photography by Visual Conspiracy.

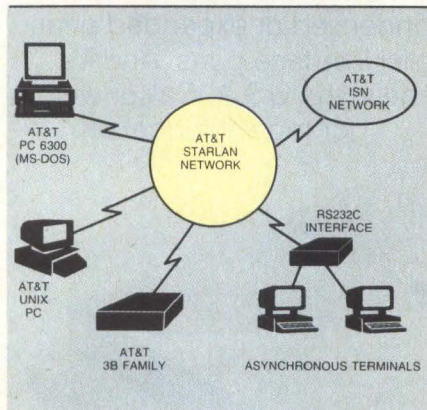

p. 23 Betting on VARs



p. 71 Automating the law

MINI-MICRO WORLD

NEWS

AT&T bets on VARs for success of UNIX PC	23
IBM PC expert systems breed new VAR markets	26
Tandem introduces low-end fault-tolerant system	27
Phoenix coprocessor expands IBM PC umbrella	34
Lotus-Cullinet alliance plans micro-mainframe link	39

INTERNATONAL

First Japanese Comdex gives glimpse of progress	45
Overheard Overseas: British group challenges Intel's OpenNet standard	48

*EUROPEAN NEWS

Europeans follow U.S. with VT220-like terminals	E1
Europeans track IBM with PCs made in Japan	E4

*Appearing in the European edition only

INTERPRETER

Buyers line up for abandoned computers	53
Multiprocessor technology means more muscle, less fat	63

VERTICAL MARKET INTEGRATOR

Law office implements multiuser micro, DBMS	71
Network automates insurance services	77

MINI-MICRO SYSTEMS (ISSN 0364-9342) is published monthly (with 4 special Digest issues) by Cahners Publishing Company, Division of Reed Holdings, Inc., 275 Washington St., Newton, MA 02158. Norman L. Cahners, Chairman; Saul Goldweitz, President and Chief Executive Officer; Ronald G. Segel, Executive Vice President and Chief Operating Officer. MINI-MICRO SYSTEMS is published by the Cahners Magazine Division: J. A. Sheehan, President; William Platt, Executive Vice President. Circulation records are maintained at Cahners Publishing Co., 270 St. Paul St., Denver, CO 80206. Second class postage paid at Denver, CO 80202 and additional mailing offices. Postmaster: Send address changes to MINI-MICRO SYSTEMS,

FEATURES

STATE-OF-THE-MARKET REPORT

Feature Highlights	83
'Power pyramid' and IBM control market	85
Venture capitalists, public relations companies and the trade press exert strong influence on most segments of the industry, but the largest single influence remains IBM.	
Demand, new players boost LAN market	97
The LAN marketplace shakeout begins as the telecommunications giants make their move.	
Micro software promotes ease of use	111
Analysts predict a healthy 63 percent annual growth rate for integrated software and a staggering 136 percent annual growth rate for environment managers.	
IBM, Apple rule office market	123
Burgeoning to \$6.6 billion in 1984, the office personal computer market boom shows no signs of abating, despite minor shakeouts.	
IBM entry spurs high-end tape drive market	137
The tape drive market is shifting away from large reel-to-reel units toward compact, high-performance cartridge-based drives. IBM may bring order to the current chaos in the 1/2-inch tape-cartridge segment.	
VAR channel skirts retail logjam	147
Vertical marketing through VARs provides an alternative to battling for retail shelf space.	
NCC panels stress international outlook	153
From the Windy City to the world: The annual NCC conference offers more than 80 technical sessions on AI, networks and architectures.	

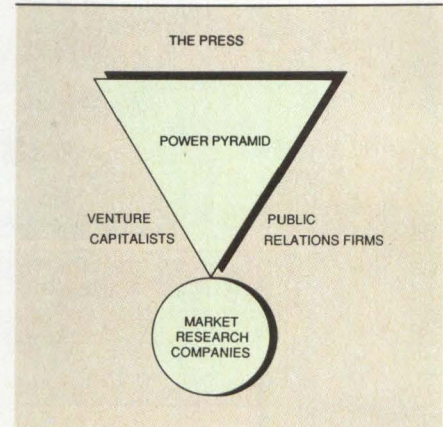

p. 85 Power trio + IBM = control

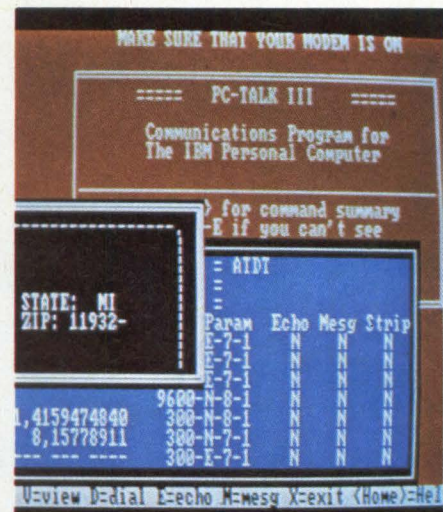

p. 111 Making it easy

DEPARTMENTS

Editorial Staff	4
Editorial	9
Breakpoints	13
New Products	158
Calendar	174
Career Opportunities	176
Classified Advertising	178
System Integrators' Notebook	179
Index to Advertisers	180
Market Track	181
Artful Intelligence	182
Mini-Micro Marketplace	183

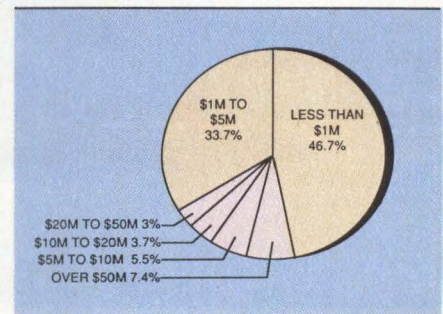

p. 147 . . . VARs provide alternative

270 St. Paul St., Denver, CO 80206. MINI-MICRO SYSTEMS is circulated without charge by name and title to U.S. - and Western European-based corporate and technical management, systems engineers, and other personnel who meet qualification procedures. Available to others at the rate of \$65.00 per year in the U.S.; \$70.00 in Canada and Mexico; \$95 surface mail in all other countries; air mail surcharge, \$35.00 (16 issues). Special DIGEST issues, \$15.00. Single issues \$5.00 in the U.S.; \$6.00 in Canada and Mexico; \$7.00 in all other countries.

© 1985 by Cahners Publishing Company, Division of Reed Holdings, Inc. All rights reserved.



We're 99.5% sure that Line Tamer™ power conditioners provide all the power protection that you'll need.

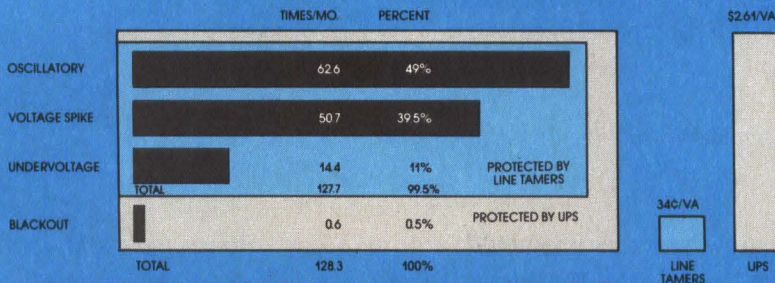

It costs \$2.61/VA for a typical uninterruptible power supply, yet power outages represent only one-half of one percent of all computer power problems. The other 99.5% are brownouts and voltage sags and surges, and oscillatory irregularities—noise and spikes—in about equal instances. So the emphasis should be on that 99.5%, and Line Tamers™ provide the protection for just 34¢/VA.

An isolation transformer only does part of the job... it protects the computer against common-mode noise. A line regulator protects against sags and surges in the power line, but not against noise. In many cases, regulators do not even provide the spike attenuation necessary to protect sensitive circuitry.

Only the ferroresonant design of Line Tamer power conditioners provides *complete protection* against noise, spikes, brownouts, even momentary power interruptions of up to 3 milliseconds. The one-half of one percent the Line Tamer won't protect against is the power outage. And that .5% makes the \$2.27/VA difference.

If power outages are not a problem in your area, save your customer that \$2.27/VA by specifying Line Tamer products instead of UPS. Call or write for your free Line Tamer technical catalog. And if you want to know more about how to provide clean power to sensitive equipment, ask about a free Line Tamer Clean Power Seminar.

LINE TAMER

THE CLEAN
POWER SOURCE
FROM

SHAPE
MAGNETRONICS, INC.

See us at NCC Booth #5003

901 DuPage Avenue, Lombard, IL 60148 Phone 1 312 620-8394 • TWX 910-991-2352

STAFF

Vice President/Publisher
S. Henry Sacks

Editor-in-Chief
George V. Kotelly

Managing Editor
James F. Donohue

Assistant Managing Editor
Bruce J. MacDonald

Senior Western Editor: **Jerry Borrell**
San Jose, (408) 296-0868
Senior Editor: **Lori Valigra**
Senior Projects Editor: **Rick Dalrymple**

Western Editor: **Carl Warren**
Los Angeles, (213)826-5818
Senior Associate Editor: **David Simpson**
Associate Editor: **Frances T. Granville**
Associate Editor: **Lynn Haber**
Associate Editor/Research: **Frances C. Michalski**
Associate Western Editor: **Mike Seither**
San Jose, (408) 296-0868
Associate Editor: **Gregory Solman**
Associate Editor: **Michael Tucker**
Associate Editor: **Jesse Victor**
Assistant Editor: **David Bright**
Assistant Editor/New Products: **Eileen Milauskas**
Assistant Editor/Research: **Pamela Gorski**
Assistant Editor/Research: **Megan Nields**

Contributing Editors

Raymond C. Freeman Jr.
Freeman Associates
Taiwan: **Charles Hintermeister**
London: **Keith Jones**, (011-441-661-3040)
Tokyo: **Ichiro Kakehashi**
Data Communications: **Walter A. Levy**
Frankfurt: **Maureen O'Gara**
United Kingdom: **Denise Danks**
Washington, D.C.: **Stephen J. Shaw**
(202) 387-8666
Gene R. Talsky
Professional Marketing Management Inc.

Editorial Production

Senior Copy Editor: **Arsene C. Davignon**
Production Editor: **Mary Anne Weeks**
Assistant Copy Editor: **Sharon Hassell**
Administrative Assistant: **Nancy Norton**

Editorial Services

Dorlis French, Terri Gellegos

Assistant to the Publisher: **Linda L. Lovett**

Executive Editor,
Cahners Computer Publications
Alan R. Kaplan

Art Staff

Art Director: **Vicki Blake**
Assistant Art Director: **Cynthia McManus**
Artist: **Anne Tregay**

Director of Art Dept.: **Norm Graf**

Production Staff

VP Production: **John Sanders**
Supervisor: **William Tomaselli**
Production Manager: **Lisa Sisterhenm**
Composition: **Diane Malone**

Editorial Offices

Boston: 275 Washington St., Newton, MA 02158, (617)964-3030. **Irvine:** 2041 Business Center Dr., Suite 109, Irvine, CA 92715. **Los Angeles:** 12233 W. Olympic Blvd., Los Angeles, CA 90064. **San Jose:** 3031 Tisch Way, San Jose, CA 95128. **London:** P.O. Box 37E, Worcester Park, Surrey, KT4 8RQ, England.

Reprints of Mini-Micro Systems articles are available on a custom printing basis at reasonable prices in quantities of 500 or more. For an exact quote, contact Art Lehmann, Cahners Reprint Service, Cahners Plaza, 1350 E. Touhy Ave., Box 5080, Des Plaines, IL 60018. Phone (312)635-8800.

Technical Bulletin

No. 2 in a series.



SUBJECT: Engineering a LAN for Maximum Flexibility.

Quantum Software Systems Ltd. proudly announces QNX 2.0 — the Ultimate Distributed Network Operating System. QNX 2.0 is now available for the IBM-PC, IBM-AT, PC compatibles, DEC Rainbow and TANDY 2000. If you have been waiting for a Real-time Multi-tasking Multi-user Operating system with fourth generation LAN support, then QNX 2.0 can offer you today what the competition can't even begin to promise for the future.

QNX 2.0 integrates the Local Area Network architecture right into the heart of the operating system, at the fundamental level of intertask communication allowing tasks to communicate transparently with other tasks across the whole network. This means that any task (program/application) may access ANY serial port, ANY printer or ANY disk on the network. There are no artificial restrictions. Every PC with a disk is a potential file server. PCs without disks will automatically BOOT over the network.

QNX on the IBM-PC AT:

QNX is the first Multi-tasking Multi-user Operating system available for the AT. It is available in both networked and single machine configurations. At about 2.5 times faster than the QNX 8088 PC based systems, and 10 times faster than other multi-tasking operating systems on the same processor, QNX is the ideal program development environment.

O/S	Computer	Processor	Measured time
QNX™	IBM-PC AT	80286	480 usec
XENIX™	Intel-286	80286	4,930 usec

File Security:

Designed with extensive file security features, QNX 2.0 provides login protection with network wide file permission checking based on 255 groups of 255 users. In addition, each PC user may control network access to devices attached locally to their machine.

Distributed Processing:

The QNX LAN supports distributed processing as well as distributed devices. Tasks may be executed on remote stations as easily as they may be executed on the local work station. This allows pure processing elements (PCs without keyboards or displays) to be plugged into the network to be used as an

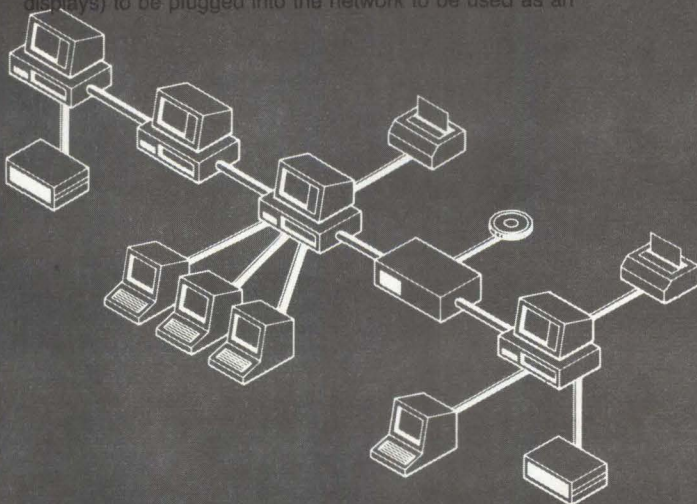

un-committed processing resource. This is ideal for real-time, process control, data acquisition and data communication applications.

Global Communications:

QNX supports a full implementation of X.25 allowing connection to public networks such as Telenet and Datapac. This allows you to link geographically separate LANs together providing true global area networking.

Cost Effective Growth and Flexible Solutions:

QNX is affordable, and will work with the PCs you use today and those you will use tomorrow. You may mix and match different brand PCs on the same QNX network with absolute ease. Multi-user expansion may be accomplished by adding terminals to PCs or PCs to the network. You can start your multi-user application on a single PC with 1 to 10 attached terminals. Once your single processor starts to show signs of degradation, add another PC and connect terminals to the new processor. If the disk becomes the major bottleneck, you may add hard disks to other attached PCs to distribute the processing. Applications which are very CPU intensive may wish to limit a single user to each processor and expand the system with low cost diskless PCs used as work stations. QNX does offer a truly cost effective and flexible solution to your applications needs.

Portability:

QNX 2.0 is portable. The operating system is independent of the physical local area network. It is available in a form suitable for porting to other 8088/8086/80186/80286 computers in the consumer, educational and industrial market place. QNX is ROMable and can operate in as little as 128Kb RAM.

DOS Compatibility:

PC-DOS version 2.1 can run as a task under the QNX 1.2 or 2.0 operating systems. QNX will also allow transparent access to the DOS file system partition and floppies.

QNX Products:

QNX Operating System	PC-DOS Emulator
Full Screen Multi-terminal Editor	Electronic Mail
Extended Utilities	Electronic Teleconferencing
C Compiler & 8086 Assembler	Full Screen Menu Developer
Basic Compiler	Learn File Utility
Qbol (dibol) Compiler	Networking Board
Text Processor	OEM Customization Kit
Real Time Spelling Checker	(to port QNX)

Established:

Quantum sold over 10,000 copies of its operating system during 1984, into all business systems environments, to developers of real time applications, government and educational systems, to software developers/integrators, universities and research establishments.



Moodie Drive, HiTech Park, 215 Stafford Rd.
Ottawa, Canada K2H 9C1 (613) 726-1893

QNX is a trademark of Quantum Software Systems Ltd., XENIX is a trademark of Microsoft Corp., IBM is a trademark of International Business Machines.

CIRCLE NO. 4 ON INQUIRY CARD

**The most complete tape
product line available—
anywhere.
Over 70,000 in service!**



It's only a start.

At Storage Technology, a continuing commitment to our OEM customers has resulted in the installation of more than 70,000 tape units worldwide. Over 90 percent of these subsystems support high-density, 6250 bpi recording.

Whenever information is processed, Storage Technology tape products are there to help. Our reputation for reliable, competitive products continues to grow. Although we've been a major supplier of tape subsystems to the OEM market for 10 years, we've only begun.

Technology that solves problems.

We believe that technology is only as good as the problems it solves. That's why we design all of our tape products with the users' needs in mind.

For ease of operation, all StorageTek tape drives feature automatic threading and loading. We've reduced costly downtime with features such as remote diagnostic capability on all 4600 tape subsystems. Our newest tape member, the 2920 series, uses large scale integrated (LSI) circuits for greater reliability, lower power and a much smaller package—key components for today's microprocessor-based systems.

Products that make good sense.

Our designs make good sense—today and for the future. That's why we offer you more choices.

Dual or tri-density models, master and slave units, streaming or traditional start/stop and more.

We have the speed, interface or configuration flexibility to meet most system application needs whether your business is seismic data processing, satellite data collection or computer aided design.

So no matter what your tape needs, Storage Technology has the tape drive to fit your system requirements.

PRODUCT SERIES	TAPE SPEED (ips)	MAXIMUM DATA RATE (KB/SEC)	ANSI RECORDING FORMAT	CONFIGURATION
2920	50,100	625	PE, GCR	Rack or horizontal cabinet mount
1900	50, 75, 125	781	NRZI, PE, GCR	Rack mount or standalone
4600	125, 200	1250 (3000 w/buffer)	NRZI, PE GCR	Standalone

People who care about OEM solutions. Every day.

We believe that an OEM supplier is an extension of your own manufacturing capability. As such, we are committed to supplying products on time, with zero defects and at a competitive price.

We'd like to talk with you about our technology, our products, and our people. We're here, doing our jobs and planning for the future so your jobs will be easier and your customers' satisfied.

Storage Technology Corporation, Louisville, Colorado 80028. Call us at (303) 673-4066.

CIRCLE NO. 5 ON INQUIRY CARD

StorageTek

Storage Technology. It's More Than Our Name...
It's Our Commitment.

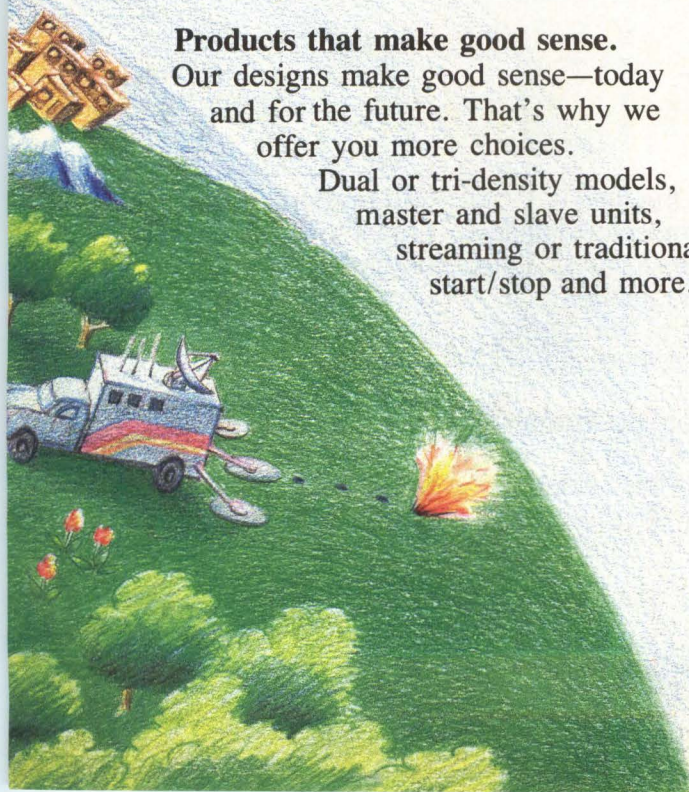

RODIME

We're producing
thousands
in your size

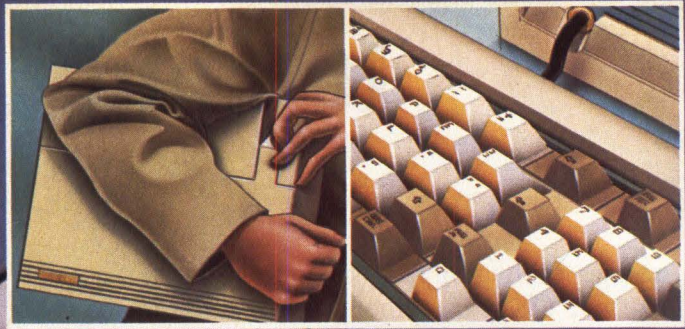

Rodime's design and production prowess in Winchester gives you the best of both worlds—5¼" or 3½". We have both out there performing dependably day in and day out, in everything from desktops to portables.

Our third generation 5¼" 200E Series drives are the lowest priced medium capacity Winchester on the

market—solidly proven by four years in the field. They offer unformatted capacities from 13.33 to 53.34 megabytes.

Our 3½" 350 Series drives are the acknowledged standard in this fast-emerging format. We're 100,000 drives ahead of the field, and currently shipping tens

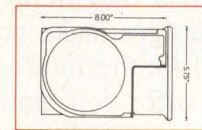
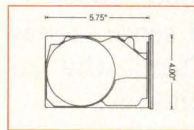

of thousands a month.

They can be configured to fit right into a full- or half-height 5¼" slot—picking up lots of memory and shock protection while substantially cutting power and heat. Phone or write for our 200E and/or 350 Series data sheets and brochure.

RODIME

901 Broken Sound Parkway, N.W., Boca Raton, FL 33431 • 305-994-6200
East: Atlanta, GA 404-980-9622 • Central: Austin, TX 512-453-5135
West: Mission Viejo, CA 714-770-3085 • Northern California: San Jose, CA 408-241-7200

CIRCLE NO. 6 ON INQUIRY CARD

EDITORIAL



COMPUTER MARKET: DOWN BUT NOT OUT

Based on first-quarter financial reports and current marketplace conditions, the computer industry shows signs of a prolonged slump. After nearly four years of explosive growth rates—greater than 80 percent annually—several market factors have combined to beat rates down to less than 30 percent annually. In ordinary business markets, a sales deceleration still produces a healthy market. However, in the financially insecure computer industry, soft sales indicate that a user saturation level has been reached. The result? Economic chaos among many computer, peripheral and software manufacturers, with underfinanced companies going out of business on a weekly basis.

What factors caused the slowdown? And what do they hold in store for the next year or so? International Data Corp. (IDC), a Framingham, Mass.-based research company, lists these factors: the strong U.S. dollar overseas, side effects of new-product cycles, strategic or tactical weaknesses in leading vendors, an inevitable bust after an historical four-year boom and a softer national economy than that revealed by most standard indices.

Other analysts cite still different contributing effects, such as Japanese and Far Eastern imports, market and technology saturation, overstocked inventories, flat and depressed sales and the overbearing IBM omnipresence. Whatever the reasons, the repercussions have bludgeoned the industry with worker layoffs, production slowdowns, plant shutdowns, executive dismissals, lower earnings and, worst of all, company failures. And these repercussions have occurred to both small, struggling vendors and to the giants of the industry, such as IBM Corp., Wang Laboratories Inc., Apple Computer Inc., Texas Instruments and Intel Corp.

The near-term trends are equally gloomy. Dataquest Corp., a San Jose, Calif.-based market research company, predicts that some 350 computer manufacturers could dwindle

down to fewer than 75 in a year.

The irony of the situation is that just a year ago, industry forecasters were projecting booming sales and growth. What happened to dampen the overly optimistic prophecies was probably "all of the above," plus the following: users who want computers already have them, users are still learning how to employ computers effectively in their daily jobs, users are still attempting to get comfortable with existing software and users are still adjusting their applications for optimum efficiency.

So, what's needed in the long term to convince the next, or more sales-stubborn, wave of users to enter the computer market in order to blunt this industry-wide slowdown? For one approach, vendors must not simply provide tools. Instead, they must also solve users' problems. Users want to add value to hardware and software. System integrators, therefore, must directly address the growth areas of data communications, micro-to-mainframe links, local area networks and office automation.

For another approach, *Business Week* says marketing will be the name of the game in 1985, and vendors who plan to survive had better listen to their customers. Still another approach involves business basics that are continually overlooked by many managers. Such basics encompass meaningful training, service, support and documentation.

In fact, a back-to-basics revolution is brewing, says authors Tom Peters and Nancy Austin. In their book, *A Passion for Excellence*, they claim that there are only two ways to create and sustain superior business performance over the long haul. First, take exceptional care of customers via superior service and superior product quality. Second, constantly innovate. In other words, organizations can attain excellence—and achieve business success—by doing a lot of little things well.

George V. Kotelly

George V. Kotelly
Editor-in-Chief

We've been starting a

Introducing the new Genicom 4000.
The line printer that offers you
a big payoff, keeps things quiet and
refuses to break under pressure.



accused of revolution.

The new Genicom 4000 offers revolutionary performance.

Fast, quiet and reliable, the Genicom 4000 offers 300 or 600 lpm with data processing and letter quality printing, bar codes, line and block graphics, plus more. The Genicom 4000 establishes a new standard by which other line printers will be measured. It is a standard of excellence never before achieved.

The new Genicom 4000 keeps things quiet.

With a standard cabinet that allows operation at less than 60 dB(A), you'll find the Genicom 4410 is quiet enough for virtually any office.

And since Genicom 4000 printers are built into their own standard sound suppression cabinet, you won't have to pay up to 20% extra for an additional quietized cabinet... often required with competitive printers that only appear to cost less at first.

Of course, if you have an especially demanding quiet application, Genicom also offers an optional 55 dB(A) sound deadening package that can be added to our standard cabinet.

The new Genicom 4000 refuses to break under pressure.

In a reliability test, the Genicom 4000 shuttle mechanism worked 24 hours a day non-stop for two and a half years without failure... the equivalent of 20 years normal operation.

This extraordinary reliability is the result of a totally new, patented resonant shuttle mechanism that's perfectly balanced, innovative in design and free of the moving parts that break down in other line printers.

The new Genicom 4000 offers you a big payoff.

The Genicom 4000 is so remarkably maintenance free, it can save enough to pay for itself. There's no preventive maintenance. Sources of costly service calls have been eliminated. And replacement parts like the print actuators are operator replaceable.

We feel the new Genicom 4000 is going to beat the competition.

But you be the judge. Call our Toll Free number for more evidence. And if you're interested in tabletop serial dot matrix printers for everything from personal computers to main frames... word processing to data processing, ask about our other Genicom printers.

**You Be
The Judge.**



GENICOM

The Printers That Mean Business.

GENICOM Corporation, Dept. 415 J, Waynesboro, VA 22980. TOLL FREE 1-800-437-7468. In Virginia, call 1-703-949-1170.

CIRCLE NO. 7 ON INQUIRY CARD

See us at NCC '85, Booth #5511



A PERFECT FIT

- 16-user support • Full-function relational DBMS
- SNA, Ethernet, X.25 • Scientific languages

The new Perkin-Elmer 3203 fits a lot into a little package. Designed to fit the office, laboratory or factory environment, it fully supports up to 16 users — at the lowest cost per user in its class.

And the 3203 is a full member of our Series 3200 family of supermini-computers. So as your application grows, your computer can too, without sacrificing software or peripherals.

Mainframe-class software

Tailored for real-time applications,

the 3203 runs not just a subset, but full versions of powerful Perkin-Elmer software. Like a complete relational database manager. Comprehensive networking. Even our high performance scientific languages.

That's real supermini versatility now and for the future, at a price starting as low as \$10,292.*

Featuring up to 4MB of memory, 170 MB fixed disk storage, a cartridge streaming tape, plus an SCSI bus for peripheral flexibility, this

low-cost entry into Perkin-Elmer computing is easy to install, configure and use. All in all, a very fitting choice.

**Fit us in:
1-800-631-2154.**

Or contact the Perkin-Elmer Corporation, Two Crescent Place, Oceanport, NJ 07757, (201) 870-4712.

*OEM quantity 100; single unit price \$16,600 (U.S. prices only)

PERKIN-ELMER

CIRCLE NO. 8 ON INQUIRY CARD

MINI-MICRO SYSTEMS/June 1985

BREAKPOINTS

VERBATIM DRIVE COMBINES OPTICAL AND MAGNETIC TECHNOLOGY

A prototype, 3½-inch, magneto-optic drive offering more than 40M bytes of (formatted) storage is expected to be shown by its developer, Verbatim Corp., Sunnyvale, Calif., at the National Computer Conference in Chicago next month. The drive, which Verbatim says should be available in evaluation models in early 1986, and produced in 1987, uses an optically assisted magnetic recording device. It offers capabilities similar to standard magnetic drives, but has greater capacity. The prototype uses a special cartridge-encased media.—*C. Warren*

TANDON MAY REDEFINE WINCHESTER PRICING

In entering the 3½-inch, 20M-byte Winchester market, Tandon Corp., Chatsworth, Calif., has established an aggressive pricing structure that may cause immediate industry-wide price cutting, say most analysts. The Tandon model TM362, a 20M-byte drive using two plated-media platters with a sputtered carbon overcoat, has an average access time of 80 msec. The drive has a rack-and-pinion actuator, a closed-loop servo and has a density of 804 tracks per inch. The company says pricing is \$300 each for OEM orders exceeding 25,000 units per year. Although it has not been officially announced, the company also has a 3½-inch, 10M-byte drive planned for use by Atari Computer Inc. in the ST series of personal computers. The 10M-byte version sells for less than \$100 in large OEM quantities.—*C. Warren*

TAIWANESE TO DEBUT \$800 PC-COMPATIBLE PORTABLE FOR OEMs

A Taiwanese company that has been trying to clear a desktop IBM PC-compatible computer through U.S. customs agents and through IBM Corp. for the past year plans to exhibit a portable PC-compatible at next month's National Computer Conference in Chicago. Copam Electronics Corp., Taipei, plans to display the President, an 8088-based model sporting dual, 5¼-inch floppy drives with a slot for a 10M-byte or 20M-byte Winchester; an 80-column-by-25-line display with a 900-by-600-dot resolution; and MS-DOS 2.11. Copam, which had a prototype of the machine at last month's Hannover Fair in Hannover, West Germany, hopes to sell to U.S. OEMs. The price to OEMs will be about \$800. The price to end users would be about \$1,600, says Copam marketing manager Ken Yu.—*L. Valigra*

PICK OPERATING SYSTEM ON THE WAY FOR PC-AT

Version 1.3 of the Pick operating system should be ready for release for IBM Corp.'s PC-AT by the end of this summer. The multiuser operating system from Pick Systems, Irvine, Calif., will sell for \$495, the same price the company charges for its package that runs on the IBM PC/XT. Other XT compatibles that Pick claims will run Version 1.3 include AT&T Co.'s 6300, Compaq Computer Corp.'s Plus and DeskPro, ITT Corp.'s ITT-XTRA, Sperry Corp.'s PC, and NCR Corp.'s NCR-PC4.—*M. Seither*

BREAKPOINTS

HARRIS TO ANNOUNCE RISC, ECL SUPERMINIS

In an effort to increase its presence in technical markets, Harris Corp., Fort Lauderdale, Fla., should this month introduce two high-performance superminicomputers: the 7-million-instructions-per-second (MIPS) HCX-7 and the 5-MIPS Harris 1200. The UNIX-based HCX-7 is the first system from a major minicomputer manufacturer to use the reduced instruction set computer (RISC) architecture, which is said to be more efficient than conventional architectures. The 1200, designed for real-time applications under Harris' VUE operating system, uses advanced emitter-coupled logic (ECL) circuits and a 288K-byte, secondary cache memory to boost performance by 55 percent over the previous top-of-the-line 1000, according to company sources. Prices for the 1200 begin at \$294,000.—*D. Bright*

YUGOSLAVIAN SOFTWARE TO COMPETE IN U.S.

Iskra Electronics Inc., Farmingdale, New York, the U.S. subsidiary of the Yugoslavian electronics manufacturer, Iskra, of Ljubljana, is introducing software for most Digital Equipment Corp. machines. Products include a program-development package for non-programmers that will be sold in the United States under the name Formation for between \$1,400 and \$9,000 for single users, depending on the size of the DEC host machine. A family of Iskra packages that includes a multiuser database management system, a data dictionary and a COBOL program generator will be sold in the United States under the name of Vitrage.—*K. Jones*

TECH FILES: A QUICK LOOK AT INDUSTRY DEVELOPMENTS

PRINTER FILES: Ricoh Company Ltd., Tokyo, plans to make a color, thermal-transfer printer available in the United States by the end of this year. Priced at less than \$400, the TP2051C prints characters in black or in as many as seven colors, all with 180-dot-per-inch resolution. The dot-matrix printer produces copy in three modes at three different speeds: draft copy at 80 characters per second (cps), near-letter quality at 50 cps and letter quality at 30 cps. A parallel interface is standard; an RS232 interface, optional. The TP2051C prints on plain paper, thermal paper or transparencies.—*L. Valigra*

MICRO FILES: Quadram Corp., Norcross, Ga., recently gave a breath of life to IBM Corp.'s discontinued PCjr computer by introducing several new products last month at the Comdex show in Atlanta. The Quadjr. expansion chassis, priced at \$695, snaps onto the side of the PCjr and supports a 360K-byte floppy disk drive. The \$275 Quadjr. memory board, which slips into the expansion chassis, adds 128K bytes of memory and is socketed to house as much as 384K bytes more. This would give the PCjr 512K bytes of memory—enough to run business packages such as Lotus Development Corp.'s 1-2-3 integrated software. Another snap-on product, the QuadMEMjr. box, adds

The fastest Perkin-Elmer compatible disk controller you can buy.

Console configuration supports future SMDs without PROM changes.

Reads and writes P-E's IDC and MSM packs.

World-wide maintenance available from P-E.

Install any size SMD drive without OS/32 software patches.

High speed formatting.

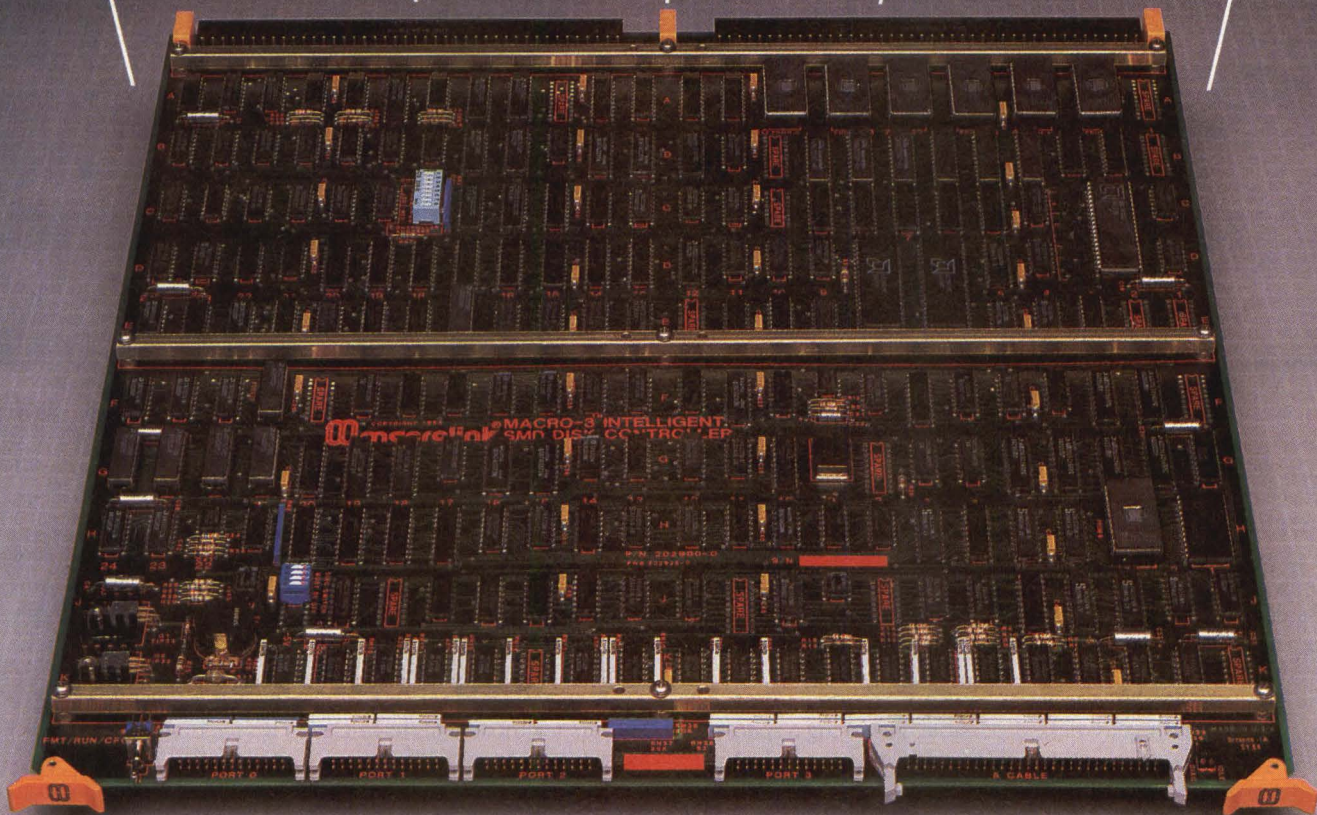

You're ready for the new generation of high performance SMD disk drives with the MACRO-3. High speed drives (over 2MB/Sec) are no problem. Only the MACRO-3 SMD controller offers full emulation of P-E disk systems, and supports advanced drives like the Eagle & CDC's FSD and XMD on any 3200 CPU. It can read

both IDC and MSM packs at the same time, a feature that P-E just can't match. And it's /XELOS/proven.

MACRO-3 is shipped from stock with installation manual, cables and a one year warranty. Of course it comes with the high reliability, tested performance and attractive pricing you'd expect from Macrolink. After all, we

invented the P-E emulating disk controller board.

Find out about the largest family of P-E compatibles going — including memory, COMM, tape and more. Call today for prices and details.

 **macrolink® Inc.**

Macrolink Inc. 1500 N. Kellogg Drive, Anaheim, California 92807 Phone (714) 777-8800 TWX 910-591-1671

XELOS and Perkin-Elmer are registered trademarks of Perkin-Elmer.

CIRCLE NO. 9 ON INQUIRY CARD

The first 128-line multiplexor to give you 128 lines.

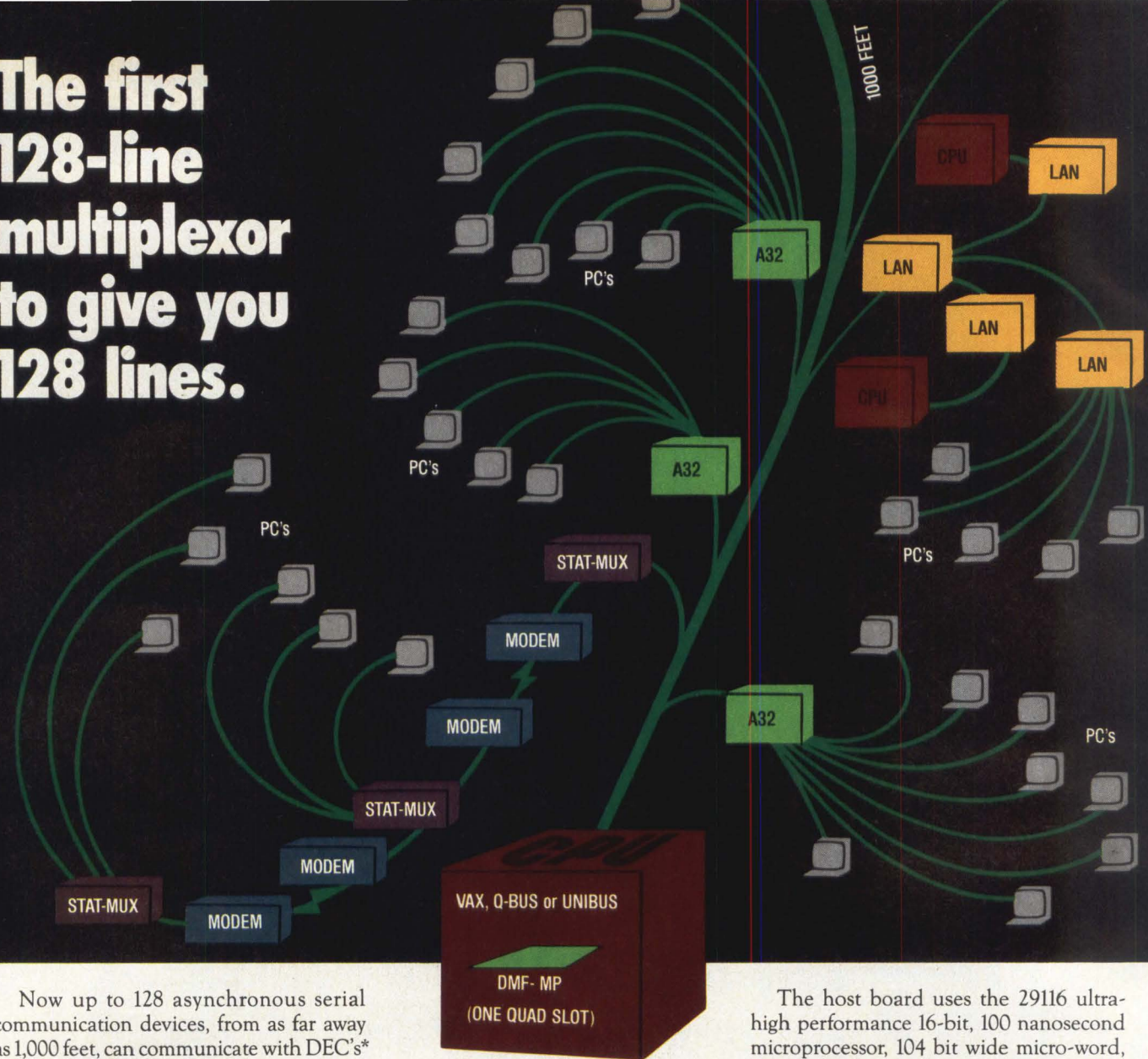

Now up to 128 asynchronous serial communication devices, from as far away as 1,000 feet, can communicate with DEC's* VAX, Q-bus and Unibus* computers.

MDB's new DMF Series Multiplexor was developed because we know systems designers need more efficient ways to control statistical multiplexors, LAN's, dynamic asynchronous terminal line switches and interprocessor links, in the new data communications world.

So from configuration to operation and installation, we've thought of everything to make it possible. Featuring a space-saving quad sized format, our DMF series is comprised of a host processor board, one or more asynchronous channel boards (A32), and a selection of connector panels.

It means true 128 line capability because terminals can be placed in up to 16 separate clusters anywhere along the 1,000 foot bus and each channel board can control up to a maximum of 32 RS32 terminals running up to 19.2 K baud (38.4 K baud optional).

*DEC, VAX, Q-bus, Unibus, RSTS/E and RSX11-M+ are trademarks of Digital Equipment Corporation.

MDB
SYSTEMS INC.

Corporate Headquarters
1995 N. Batavia Street, Box 5508
Orange, CA 92667-0508
Tel. 714-998-6900 TWX: 910-593-1339
FAX: 714-637-4060

MDB Systems U.K., Ltd.
Basingstoke, Tel. 44 0256 464767
TELEX: 858389 MDBSYS G

In the western states MDB products are also distributed by

WYLE
LABORATORIES

ELECTRONICS MARKETING GROUP

CIRCLE NO. 10 ON INQUIRY CARD

See us at NCC Booth #s 5103, 5104, 5202, 5203

BREAKPOINTS

from 128K bytes to 512K bytes to the system. It is priced at \$275 for 128K bytes, \$675 for 256K bytes, and \$995 for 512K bytes. All three products are available now.—*L. Valigra*

NOTES FROM OVERSEAS: A group of Control Data Corp. disk-drive-media veterans has secured \$12 million from Rodime Plc. and Citicorp Venture Capital to seed one of the most highly leveraged British high-technology start-up companies ever. The newcomer, called **Data Magnetics Ltd.**, plans to develop and manufacture 3½-inch and 5¼-inch thin-film-media hard disk drives to be used with office personal computers. The company plans to ship its first product next year. Reportedly, there also are plans to develop large disks for mainframe computers. These drives would store as much as 2G bytes of data. Data Magnetics may even work with a Japanese company to offer optical drives, sources say. The company plans to sell mostly to European computer makers.—*M. O'Gara*

Maxell Europe GmbH, Düsseldorf, West Germany, displayed a high-capacity, 10M-byte (unformatted), 5¼-inch, metal floppy disk for the first time in Germany at last month's Hannover Fair. But Hitachi Maxell Ltd., Tokyo, was still readying the drive to run the disk. Hitachi sources say the drive, whose technology was introduced last October at an exposition in Tokyo, will not be available in the foreseeable future. A prototype, which uses a special head made of an amorphous magnetic alloy, has been developed in the laboratory, but no second source for the drive or the media has been signed. The 1,500-Oe, metal, floppy disk stores from 6.5M bytes to 8M bytes when formatted. It employs MFM recording, has a recording density of 40,365 bits per inch and a density of 127 tracks per inch. Price and time of availability of the media to OEMs is not known, said a Maxell source at Hannover, because the only drive it will now run on is the prototypical Hitachi unit. The Maxell source says the media should eventually be available for other drives and for retail distribution.

—*L. Valigra*

Following in the steps of other British companies such as ICL Plc. and ACT Ltd., **Commodore International Ltd.**'s UK operation is trying to get a slice of the Russian computer market. Quiet negotiations reportedly are taking place for Commodore's 16-bit, IBM-compatible computer and a Z8000 processor-based microcomputer. If the Commodore subsidiary secures a deal with the Soviets, it will be the first company with an American parent, (Commodore International Ltd., U.S.A.) to officially sell personal computers to the Soviet Union. Commodore already sells in the Eastern bloc; it expects to sell \$5 million to \$10 million worth of equipment to Hungary this year.—*M. O'Gara*

BREAKPOINTS

Although Japan's Fifth Generation computer project is still in the early stages of its 10-year plan, the Japanese already are envisioning a so-called **Sixth Generation** computer project. An advisory group within the government's Science and Technology Agency wants Japanese computer researchers to develop a machine that can understand and process natural human speech and form images. The Fifth Generation project focuses on inference-based logic processes. The group wants the new, basic research to include physiology, psychology, linguistics and logic, in order to determine how humans translate sensory information into thought.—*I. Kakehashi*

NEC Corp., Tokyo, has acquired Honeywell Information Systems Japan Inc. and has renamed it NEC Computer Systems Ltd. NEC and Honeywell have had cross-licensing arrangements for the past 23 years. The new company will be Honeywell's sole computer sales-and-service operation in Japan. The terms of the acquisition were not disclosed, but the

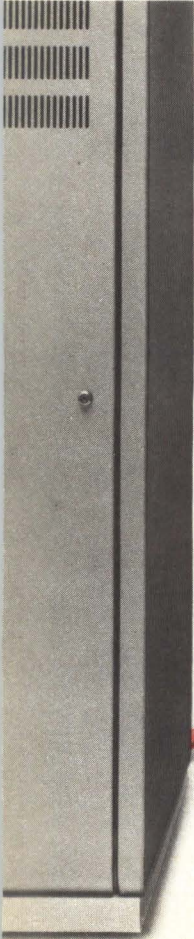

The terminal on the right
outperforms the competition.
And costs less.

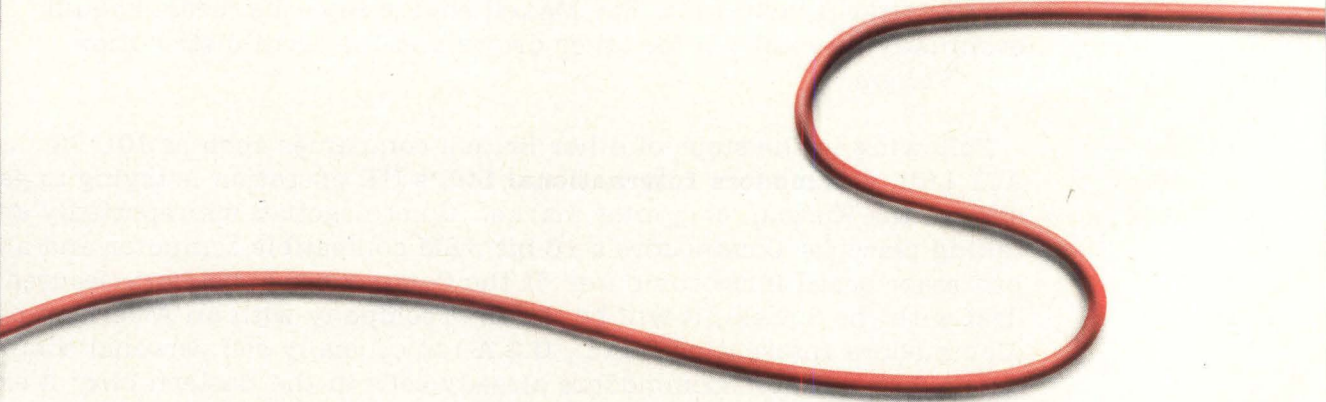

arrangement provides NEC with 360 former Honeywell employees—including 70 system engineers—and Honeywell's customer base. NEC hopes that sales to those customers will be worth more than \$38 million over the next year.—*I. Kakehashi*

Sources at **Convergent Technologies Inc.**'s European offices say the company plans to announce this month an 80286-based version of its N-GEN workstation. Delivery schedules are not known. Another possible newcomer, they say, is a product called "Mighty Frame," which would support eight to 16 users and fit between the MC68010-based Miniframe and the multiple-MC68010/multiple-80186-based Megaframe in Convergent's product lineup. Another product reportedly being developed in the United States by Convergent is the Megaframe 2, which houses the company's proprietary CTOS operating system in firmware while still running UNIX System V.—*M. O'Gara*

The computer on the left doesn't care about the price.

A computer is born to perform. No matter what the price. You, however, have practicalities to think about. Making your computer perform the way it's meant to is one. Watching costs is another. And you have to blend the two to create the most valuable, cost effective system possible.

CIE Terminals has a video terminal that'll make you both happy. The CIT-220+.

It's a remarkably reliable piece of technology that yearns to show its stuff as much as the computer it's hooked up to. Something they'll both get plenty of chances to do. That's because the 220+ is so reliable, it's always up



and running. Which means your computer is, too.

The 220+ is compatible with the DEC VT220. But it's not comparable. That's where the plus is. You'll find no less than 20 improvements and additions that make the most of your computer.

And because the 220+'s price is in direct contrast to its high performance, you get the best value for your money.

So although the computer doesn't care about the cost, you don't have to think about it, either.

For more information on the CIT 220+, contact your distributor or CIE Terminals at 2505 McCabe Way, Irvine, CA 92714-6297 (800) 624-2516.

CIE TERMINALS
A CITOH ELECTRONICS COMPANY

CIRCLE NO. 11 ON INQUIRY CARD

Because your computer is only as good as its peripherals.

**Introducing
The Single
Solution To
Many Problems
That Can
Tie Up Your
Personal
Computer.**



Transet 1000.™ The print buffer, communications buffer, port expander, printer sharer and I/O switcher. All in one.

Anyone with a personal computer and one or more peripherals has faced the all-too-familiar dilemma. You need your computer to do an important job. But you're forced to wait for the system to finish one job (printing, communicating, whatever) before you can go on to the next one. Or you need to stop what you're doing to switch cables when you want to use another peripheral.

Wait no more. Now Hayes introduces an innovative new device that lets you perform many jobs—at the same time—independent of your computer. Transet 1000. It works with a wide range of systems and configurations. And it allows you to continually expand your system as your needs grow.

Transet 1000 frees your computer from waiting on your printer or modem—so you and your computer can go on to another task. It even lets you

print out documents in pre-set formats without having to go back into your computer. At the same time, Transet 1000 can operate unattended mailbox communications—24 hours a day—even if your computer is turned off.

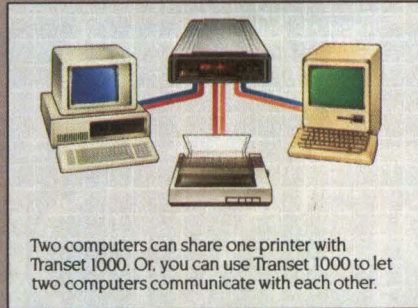

Two computers can share one printer with Transet 1000. Or, you can use Transet 1000 to let two computers communicate with each other.

In addition, Transet 1000 is a port expander and software-controlled I/O switcher. Now files can be easily directed and redirected to different peripherals, without physically changing cable connections.

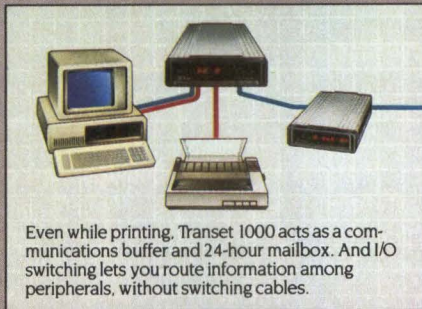

Even while printing, Transet 1000 acts as a communications buffer and 24-hour mailbox. And I/O switching lets you route information among peripherals, without switching cables.

Transet 1000 contains a stand-alone microprocessor, and comes with 128K of memory. It operates with any RS-232 interface computer, and has optional accessory kits available for the IBM® PC and PC XT, Macintosh™ and

Apple® IIc. Kits contain the necessary host cable, a user guide and menu-driven software that lets you graphically set up or customize port

parameters and printing formats. Cables available for IBM PC AT, other computers and peripherals.

Like all Hayes products, Transet 1000 combines sophisticated capabilities with easy operation. Just as Hayes set the standard in personal computer communications, now Hayes is taking the lead in computer task management.

Contact your authorized Hayes dealer to see how Transet 1000 can help you get a lot more productivity



Transet 1000 allows printing on both a dot matrix printer and letter quality printer, while freeing your computer for other tasks.

out of your computer system—without tying up your computer or you.

Hayes Microcomputer Products, Inc., P.O. Box 105203
Atlanta, Georgia 30348
404/441-1617



Hayes products now available under GSA Contract No. GS00K85AGS5080.

Hayes® Transet 1000

Innovative products for enterprising people

DECLARE YOUR DATA INDEPENDENCE.



When In The Course Of Business Events . . .
OEMs designing business systems face two new

realities. One, data processing is becoming more distributed—more individualized work units, defined by job function and application, performed by more people in more places, demanding more independence.

The second reality? Winchester's. This prevailing storage technology is headed in a direction that's just the opposite of data independence—tying users to shared storage systems, large or desk-top.

Slavery By Any Name . . .

The central issue is no longer just more data. It's *more data dynamics*. And Winchester's aren't really dynamic at all. Consider "wait your turn" access, or the need for lots of user "system savvy." Consider time-consuming backup and restore. And consider the ever-present risk of expensive head crashes. Now consider the IOMEGA alternative.

IOMEGA's Distributed Data Storage: Freedom Of Information.

Our family of data management/storage systems matches the distributed data processing reality with a new reality: *distributed data storage*—with systems whose reliability and specs often exceed Winchester's, particularly in access times and transfer rates, and with cost-per-megabyte figures that Winchester's simply can't figure.

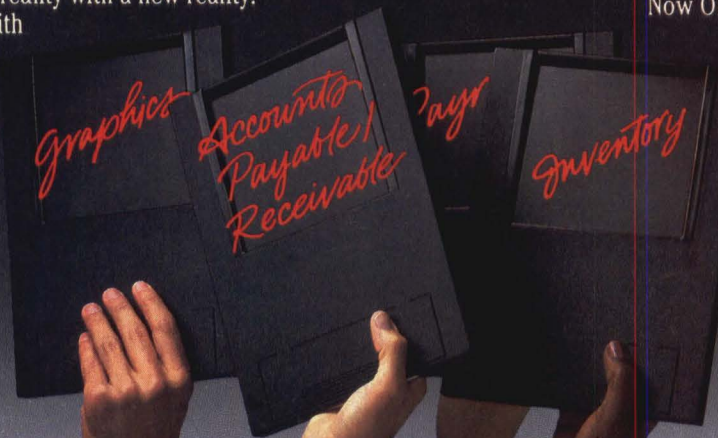

	IOMEGA BETA 5	IOMEGA ALPHA 10/10H	TYPICAL WINCHESTER
Formatted Capacity	5.0 Mbytes per cartridge	10.0 Mbytes per cartridge	10.0 Mbytes fixed
Data Transfer Rate	5.0 Mbits/Sec	9.0 Mbits/Sec	5.0 Mbits/Sec
Average Access Time	50 msec includes settling	35 msec includes settling	85 msec
Form Factor	5.25"	8"/8" Half Height	5.25"

The IOMEGA cartridge is the key. Now download data and software to a 5- or 10-megabyte cartridge, then manipulate, update, and upload conveniently and efficiently. The result is a total enterprise solution that can store applications, complex programs, or data sets—all of which can then be passed along to others without networking. And when you need more storage, you use more cartridges, not more hardware.

Accept No Alternatives.

IOMEGA's distributed data storage solutions—full and half-height 8-inch 10-megabyte and a 5¼-inch 5-megabyte versions—give OEMs Winchester performance and reliability with floppy convenience and cost-efficiency. They are proven, risk-free solutions. And IOMEGA's cartridges are the only ones that are truly rugged, fully interchangeable, and inexpensive.

Now OEMs gain the *freedom of designed-in freedom*. The freedom today's customers require.

So take the liberty of calling an IOMEGA representative today. There's one in your area.



IOMEGA CORPORATION
1821 West 4000 South
Roy, Utah 84067
(801) 776-7330

CIRCLE NO. 13 ON INQUIRY CARD

IOMEGA HAS REMOVED CAPACITY AS THE MASS STORAGE ISSUE.

MINI-MICRO WORLD

NEWS

AT&T bets on VARs for success of UNIX PC

Stephen J. Shaw
Washington Editor

Apparently conceding the mass desktop market for personal computers to IBM Corp., AT&T Co. is pursuing niche markets through value-added resellers for its new UNIX PC micro-computer. At the same time, AT&T is actively courting software developers to support the UNIX operating system and to port increasing numbers of popular application software to UNIX.

Disappointing sales of the PC 6300, estimated at 20,000 units in 1984, coupled with a lack of widespread acceptance of the UNIX operating system by end users, are forcing AT&T to rethink its ambitions of recreating the success of the IBM PC, according to analysts.

Consequently, AT&T is taking a different marketing tack with the UNIX PC. The company has established relationships with 52 VARs serving more than 60 regional and vertical industry segments and is actively pursuing more.

"The VARs will be effective for niche markets and are a critical element in our distribution strategy," comments Richard Holbrook, president of large business systems for AT&T Information Systems (ATTIS).

Software hunt is on

The writing of software-interface specifications for the UNIX PC has been turned over to independent and third-party software developers in an attempt to spur the development of more application packages. In addition,



AT&T's new UNIX PC, which includes a mouse cursor controller and menu and window displays, competes head-on against IBM's PC-AT, which runs XENIX.

tion, AT&T has been quick to release hardware specifications for the UNIX PC to create what company executives call the "AT&T-compatible market."

"We realize we're not overburdened with a plethora of [UNIX-based] application software," concedes Charles Redmond, general manager for computer systems at ATTIS. "VARs are a critically important area for us because it centers our strategy on acceptance of UNIX in the marketplace."

AT&T provided additional evidence

that it is aware of the relative dearth of UNIX application software when it included 28 packages in its spring announcement of the UNIX PC. Half of those, however, are aimed at programming and development applications. Among the remainder are Multiplan, a spreadsheet program from Microsoft Corp., and the popular dBASE III database-management package from Ashton-Tate.

At a New York press briefing for the new products, AT&T computer sys-

tems president James D. Edwards made a point of introducing executives from various software-development companies, including Bill Gates, Microsoft president, and officials from Ashton-Tate, Santa Cruz Operation Inc. and others.

Edwards promised that the number of software packages for the UNIX PC would double this summer. Six application centers and hot-line numbers have been established specifically for VARs to work with AT&T programmers in developing additional software.

AT&T needs more software variety

A greater variety of application packages must reach VARs quickly for

the UNIX PC to succeed, analysts say. Although the UNIX System V operating system offers multitasking, multi-user capability, it faces stiff market competition from more established systems such as the Altos Computer Systems 586, the Convergent Technologies Inc. Miniframe, the NCR Corp. Tower XP and the Perkin-Elmer Corp. 7358.

"If the UNIX PC is going to do well in the market, extremely well, AT&T has got to pull it together by the end of the summer and make additional introductions of popular application software," says James Sullivan, senior analyst with research company Yates Ventures, Palo Alto, Calif.

As AT&T admits, the UNIX PC is

aimed squarely at the IBM PC-AT market. In benchmark tests performed by Yates, the UNIX PC outscored the PC-AT by 520 points out of a possible total of 1,500 points, weighted across a variety of operating parameters.

Sullivan estimates that AT&T will realize 25 percent of its UNIX PC sales through VARs. Another 10 percent of sales will be achieved through AT&T's master distributors, Ducommun Data Systems Inc., Cypress, Calif., and Unicore Inc., Austin, Texas. Ducommun and Unicore act as resellers of AT&T equipment to VARs projected to move less than \$1 million worth of AT&T computer equipment annually. Larger VARs are handled directly by ATTIS.

Sullivan also predicts that 10 percent

A glimpse of AT&T's UNIX personal computer:

AT&T Information Systems has unveiled the latest addition to its young computer family, the UNIX PC model 7300, offering voice and data features in a desktop package starting at \$5,095. Taking aim at IBM Corp., AT&T Co. executives claim the UNIX PC offers better performance for \$900 less than the price of an IBM PC-AT.

Manufactured by Convergent Technologies Inc., Santa Clara, Calif., to AT&T's design, the UNIX PC incorporates a 10-MHz Motorola Inc. MC68010 CPU, the UNIX System V operating system and a mouse to enter commands and perform screen functions. Apparently for fear that not supporting the ubiquitous DOS operating systems would be suicidal, AT&T designed the UNIX PC to support the MS-DOS 2.1 and PC-DOS 2.0 or 2.1 operating systems.

The 7300's on-board 512K bytes of RAM are organized into a 4M-byte virtual-memory system. A 10M-byte hard disk drive and a 0.5M-byte floppy disk drive are standard. A 20M-byte hard disk and a 1M-byte floppy disk drive are also available.

AT&T claims that UNIX's "unfriendliness" toward new users has been eliminated with the addition of several software enhancements, including a user-interface system that shields the operator from the complex UNIX command structure. But the user interface "adds a big shell and is visibly slow," comments James Sullivan, senior analyst with research organization Yates Ventures, Santa Clara, Calif.

The mouse lets users enter data and select system options from on-screen icons. Files can be shared and other data transmitted through a built-in, 300- to 1,200-bit-per-second modem.

**TYING TOGETHER
AT&T PERSONAL COMPUTERS**

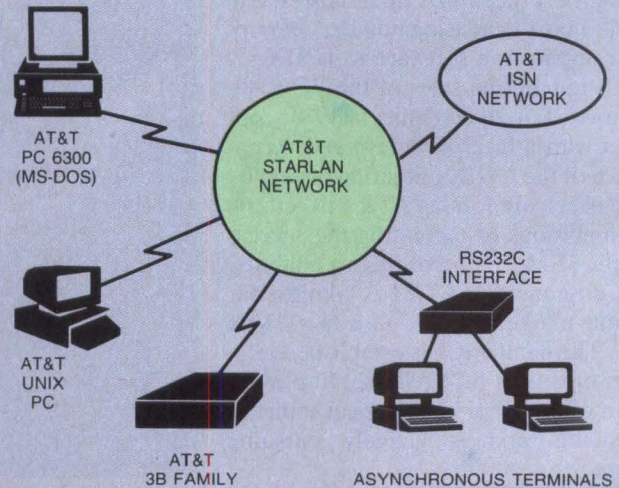

The Starlan local network ties computers using both UNIX and MS-DOS operating systems.

Two telephone lines can be connected to the personal computer with ordinary modular telephone jacks in the rear of the processor. A communications-manager board-level system allows users to control a variety of telephone activities automatically. These include message services such as tracking incoming and outgoing calls with a call-history file and use of an on-line phone directory.

Voice and data signals can be transmitted simulta-

of sales of the UNIX PC will be by retail computer outlets. According to AT&T, more than 1,000 computer specialty retailers are now authorized to sell AT&T computers. The company anticipates that an additional 600 stores will be signed by the end of this year.

Approximately half of the UNIX PC's sales will be derived from ATTIS' 7,000-person direct sales force located in 180 branch offices around the country. This group recently was reorganized into three new divisions: large business systems, general business systems and computer systems. It will sell to large Fortune 2,000 companies aiming toward system sales of \$25 million to \$30 million.

Convergent Technologies, Santa Clara, Calif., will manufacture 45,000 UNIX PCs for ATTIS during the remainder of this year, predicts Sullivan. Approximately 30,000 units will be sold through all distribution channels.

According to a survey of 2,000 VARs and system integrators recently completed by Natick, Mass., research company Venture Development Corp. (VDC), the overall demand for UNIX will increase among VARs from 24.7 percent to 75.2 percent during the next two years. The market through VARs for all personal computers is expected to rise from \$2.23 billion in 1985 to \$5.22 billion in 1989.

VDC analyst Sharon Kern estimates that AT&T ranked fourth in market

share for 1984 in the shipment of all microcomputers to the VAR segment, behind IBM, Convergent and Digital Equipment Corp. "AT&T moved between 5 percent and 10 percent of the total shipped through VARs," she says.

AT&T hopes to do better than that this year with the UNIX PC. "We've already received orders for several thousand UNIX PCs," says AT&T's Holbrook. Although Holbrook acknowledges that last year's sales of the 6300 did not live up to expectations, he stated at the New York briefing on the UNIX PC that AT&T sold more microcomputers during the first two months of this year than during all of 1984. □

A 'friendly' challenge to the PC-AT

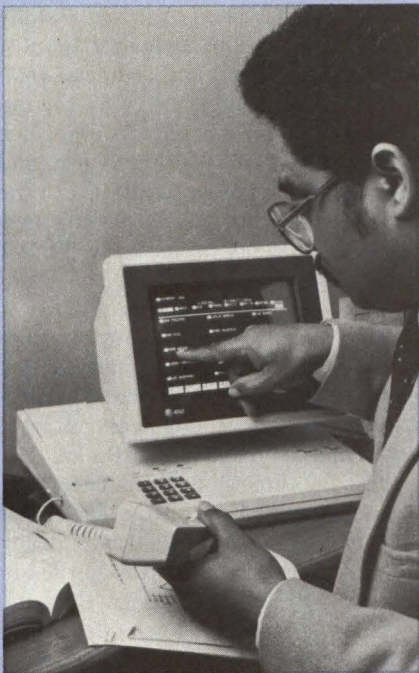

AT&T's personal terminal combines voice and data communications on a terminal equipped with a telephone handset and a touch screen.

Market analyst Jean Yates, president of Yates Ventures, is optimistic that the new UNIX PC will bolster AT&T's microcomputer sales. "By the end of 1985, AT&T will be No. 2—or No. 3 at least—in personal computer sales," Yates told attendees at a recent Washington computer conference.

She predicted that AT&T would sell approximately 60,000 UNIX PCs, and more than 200,000 6300s by the end of this year.

Along with the UNIX PC, ATTIS has announced additional hardware and software packages. These include:

- The AT&T personal terminal, a voice- and data-communications terminal equipped with a telephone handset and a touch screen. The terminal runs off the System 75 or System 85 private branch exchange and features a four-line, digital telephone, a speaker-telephone, an auto dialer and a data terminal with built-in calculator and calendar functions. The terminal will be available starting in May at \$1,795.

- The Starlan local network for personal computers. The network links computers using both UNIX and MS-DOS operating systems. A typical configuration to link a UNIX-based computer and an MS-DOS machine would sell for approximately \$1,500. The network will be available in the fourth quarter of this year.

- A total of 28 application-software packages for the UNIX PC. These include Ashton-Tate's dBASE III database-management system, Microsoft Corp.'s Multiplan spreadsheet and Word word-processing system, graphics packages and a number of programming tools.

neously on two telephone lines. Communications is supported with other PC 7300s, other UNIX-based workstations, MS-DOS and CP/M workstations, UNIX-based or IBM host mainframes and other asynchronous hosts or database services. Interconnection with host computers can be accomplished by responding to on-screen prompts. Users of AT&T's PC 6300 can upgrade their systems to the new PC with expansion cards.

IBM PC expert systems breed new VAR markets

Michael Tucker, Associate Editor

Expert systems, once confined to very expensive LISP- and Prolog-based machines, are starting to show up on the IBM Corp. PCs of shoestring entrepreneurs.

Expert systems are one of the many branches of artificial intelligence. Basically, they're programs that simulate the problem-solving techniques of human experts. They're usually divided into a knowledge base (the actual information an expert programmer imparts to a system) and an inference engine (the part of a program which applies that information to draw conclusions).

In the last few months, a number of inexpensive expert-system shells, or generators, have been introduced. Some of the newest include KDS from KDS Corp., Wilmette, Ill.; Expert Edge, from Human Edge Software Corp., Palo Alto, Calif.; and RuleMaster, from Radian Corp., Austin, Texas. KDS and Expert Edge cost under \$1,000. If such products should prove successful they could offer value-added resellers an entirely new software market.

KDS is a powerful shell in a tiny package. It allows a developer to build an expert system simply by entering case histories in natural language. The

company says KDS can produce 16,000 rules from up to 4,096 case histories and yet run on any IBM PC or compatible without a hard disk. KDS manages this feat of compression partly by being written entirely in Assembly language and partly by being divided into three parts.

Rather than bundling the expert shell, inference engine and knowledge base into a single, large program, KDS Corp. makes each component a single, smaller piece of software. Developers would buy a Development System, at a cost of up to \$795, which they would use to produce Knowledge Modules, the actual expert-system shell. They would then market these Knowledge Modules to users, who, in turn, must purchase a KDS Corp. inference engine, called a Playback Module, for \$495. The Playback Module would then use the information in the Knowledge Module to draw conclusions and give advice.

In effect, only KDS Corp. sells KDS software, while the developer sells pure information. This means that the user must buy both a Knowledge Module from a developer and a Playback Module from KDS Corp. Although involved, this process eliminates the need for licensing agreements.

Human Edge has been selling one expert-system shell, Expert Ease,

since 1984. Now, they've purchased the right to market a second shell, Expert Edge from Helix Expert Systems, London.

Expert Edge, or Tess as it's known in the United Kingdom, allows developers to build expert systems by entering the set of rules they use to arrive at particular decisions. It is priced at \$795 for an IBM PC or compatible.

Users say that with Tess, no formal computer training is required in order to build simple expert systems in only a few hours. Helix officials, however, say that to make Expert Edge really useful, a developer would almost certainly need a knowledge engineer (an individual trained in extracting and coding information).

Radian masters the shell game

RuleMaster, from Radian, is meant for industrial-scale applications—meaning it has been used successfully in such applications as fault diagnosis, weather prediction and chemical analysis. It was written in C to run on multiuser, UNIX-based systems such as those from Perkin-Elmer Corp. and Gould Inc. For those applications, the package is priced at \$25,000. RuleMaster costs \$5,000 in its IBM PC/XT version and \$15,000 for the IBM PC-AT version.

RuleMaster automatically induces rules from examples in natural language supplied by an expert. Alternately, knowledge engineers, using a command language called Radial, can write code directly to RuleMaster.

Like Expert Edge, RuleMaster has roots in Great Britain. It was developed in association with professor Donald Miche of Edinburgh University's Turing Institute. Miche developed Expert Ease, Human Edge's first entry into the expert-shell market.

Some observers, however, doubt that any expert system running on existing personal computers can really handle serious problems. Dr. Bruce B. Johnson, a partner with consultants Arthur Andersen Co., Chicago, notes, "We haven't seen one [expert system] yet on a personal computer that will handle real-world problems. They're basically toys in that you have to pick a

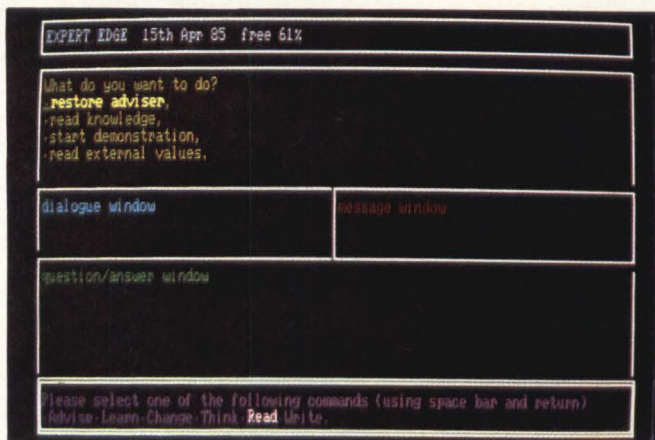

Expert Edge, from Human Edge, allows developers to build expert systems for the IBM PC. Users say it's possible to build simple systems in only a few hours.

problem that fits the system."

Still, IBM PC expert systems are finding users. The Chicago office of the accounting company Price Waterhouse has recently purchased KDS to assist some of its accountants in determining what is taxable income for some corporations. "We've even had

people asking about such mundane things as setting up an expert system on how to run a city park," says KDS Corp. president Barbara Wallace.

VAR strategies for the expert system market have already been worked out—in theory. Developers would either be experts or hire experts in a

certain field—say, industrial-chemical analysis or growth-fund stock behavior. They would then purchase an expert-shell package, sit down with the human expert and gradually produce a program that mimicked the expert's thinking when confronted with certain select problems. □

Tandem introduces low-end fault-tolerant system

Mike Seither

Associate Western Editor

Tandem Computers Inc., Cupertino, Calif., the leading manufacturer of fault-tolerant computers, has moved into the low-end of the market with a new, compact system designed for remote transaction processing.

By offering a system that can be installed easily at the department level, the company hopes to garner business, not only from its existing

customer base but also from smaller companies that can grow to need bigger Tandem systems.

And to help peddle its new machine—the NonStop EXT—Tandem has instituted a reseller program that will for the first time allow OEMs to sell in the same markets as Tandem's end-user sales force. Tandem officials hope this arrangement will help the company penetrate smaller segments of certain markets, especially retailing and finance, at less than the cost associated

with direct sales.

The EXT, priced at \$120,000 and capable of operating in an office environment rather than in a computer room, is compatible with other Tandem computers and software and can function as part of a large Tandem network, according to the company.

"One of the barriers we've had with our [midrange] NonStop II is that, although it can be priced as low as \$150,000, it still requires a computer room," says Gerald D. Held, Tan-

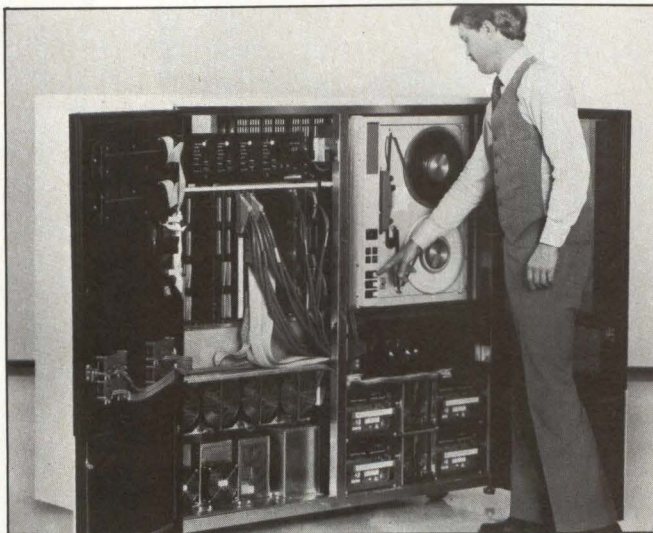

Two Winchester disk drives are standard equipment on the NonStop EXT, but there is room in the cabinet for a total of four, as shown.

Although Tandem is the leading manufacturer of fault-tolerant systems (fiscal year 1984 sales: \$533 million), IBM still controls the lion's share of the transaction-processing market.

THE TRANSACTION-PROCESSING MARKET

(1984 estimations)

TOTAL: \$22.2 BILLION

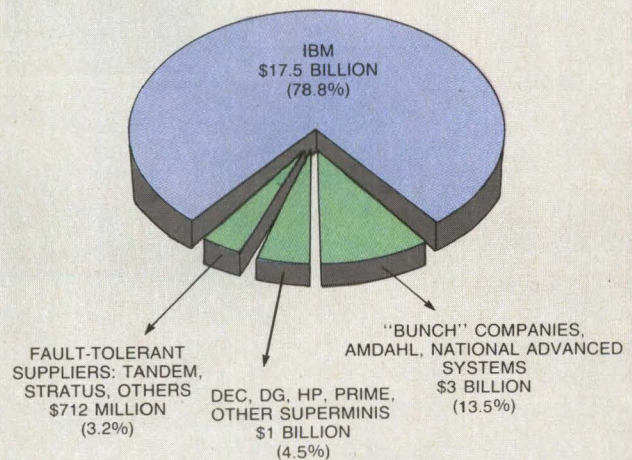

SOURCE: ITOM INTERNATIONAL CO.

EMULEX IMPROVES AND TAPE BACKUP BY

Emulex sets the pace with three great storage subsystems for the full range of DEC QBus and Unibus systems. Whether you need Winchester disk, cartridge disk, 1/4" streaming tape, or a combination unit, you'll be a step ahead with Emulex.

INTRODUCING VAULT.™

Emulex rises above the competition with the Vault.™ This 70-MByte tape subsystem is built around the CDC Sentinel 1/4" cartridge tape streamer and uses Emulex's own TC05 (QBus) or TC15 (Unibus) tape coupler to interface with your system. The Vault is totally software transparent to standard TS11 software. So this compact tape unit looks just like a big 1/2" TS11 subsystem to your operating system and diagnostics.

Vault comes complete with power supply in a single compact cabinet. It's the perfect backup unit for smaller QBus systems such as the MICRO/PDP-11 and MICRO/VAX.

PRESENTING SABRE.™

SABRE™ is a sharp solution for LSI users who need more storage and backup. It packs 31.2 MBytes of main storage onto a 5 1/4" Winchester and 10.4 MBytes of backup onto a removable 8" cartridge disk.



And since SABRE is an exact RL02 emulation, all existing operating and diagnostic software can be used as is.

SABRE is 5 1/4" high and slips into any 19" RETMA enclosure. A desktop version is also available. Both come complete with power supply, host adapter and connecting cables.

SABRE needs only one-eighth the space and one-quarter the power of four RL02s. And it eliminates the need for a separate system bootstrap, bus terminator and clock control board.

*DEC, QBus, Unibus, TS11, MICRO/PDP-11, MICRO/VAX, LSI and RL02 are trademarks of Digital Equipment Corporation. CDC and Sentinel are trademarks of Control Data Corporation.

GSA Contract # GS00K84015575



DEC DISK STORAGE LEAPS AND BOUNDS.

ANNOUNCING MEDLEY.™

Emulex has another winning combination with the Medley™ Winchester cartridge tape subsystem. It gives you either 35 or 110 MBytes of formatted storage and up to 70 MBytes of streaming tape backup. The Medley is fully software transparent to the operating system and diagnostic software of QBus and Unibus CPUs. And it uses the powerful and versatile Small Computer System Interface (SCSI) which keeps your options open for peripheral expansion.

Medley is interfaced to the system with a TC05/TC15 tape coupler and a UC02 (QBus) or UC12 (Unibus) host adapter. By using the Mass Storage Control Protocol (MSCP), the UC02 and UC12 allow the operating system to utilize the precise characteristics of the Winchester disk drive without patches or modifications to the operating system.

For convenience, Medley's disk drive, tape drive and power supply all fit into an attractive cabinet that easily mounts in a standard 19" rack. The Medley is also available in an attractive desktop version.

Find out how Emulex subsystems can keep you ahead of the game. Call toll-free (800) 854-7112. In California (714) 662-5600. Or write Emulex Corporation, 3545 Harbor Blvd., P.O. Box 6725, Costa Mesa, CA 92626.



The genuine alternative.

CIRCLE NO. 14 ON INQUIRY CARD

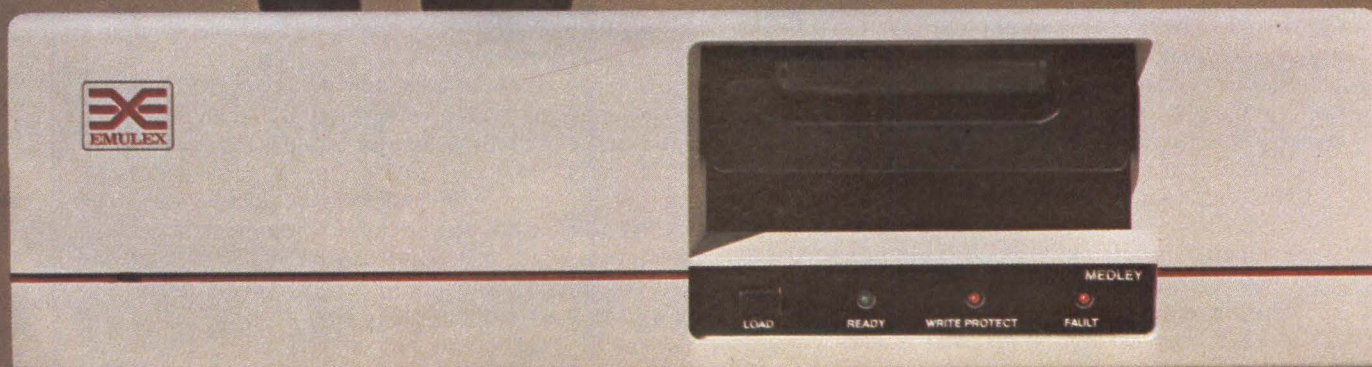
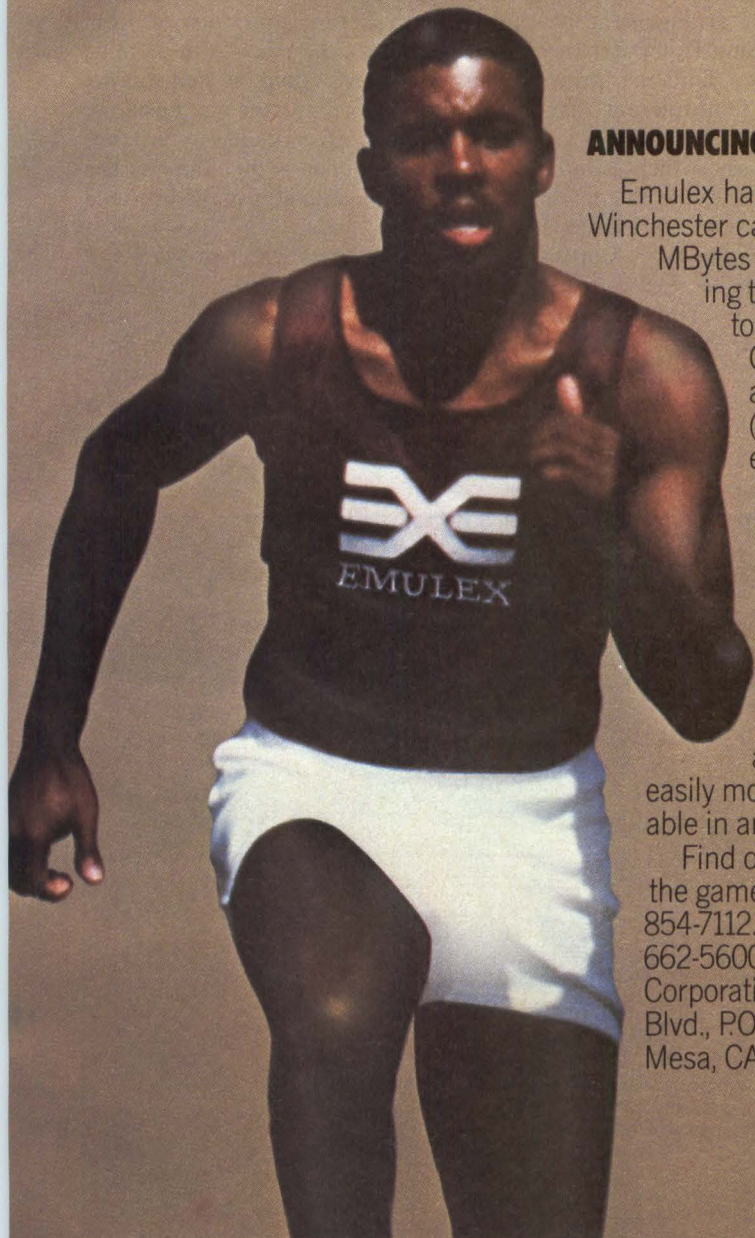

dem's director of strategic planning. "Air conditioning, raised floors and special power can add \$50,000 to a system's total cost. The EXT offers customers on-line transaction processing for the cost of only the system itself."

The system comes in a single cabinet that occupies 11.8 square feet of floor space, stands 5.5 feet high and is narrow enough (31 inches) to be wheeled through standard doorways. Processors, disk drives, power supplies, backup batteries and cooling equipment are all inside the cabinet.

Tandem announced the EXT just weeks after IBM Corp. announced System 88, the first fault-tolerant line

of computers to bear Big Blue's logo. The three IBM machines are the offspring of an OEM arrangement between IBM and Stratus Computer Inc. of Marlboro, Mass., Tandem's prime competitor in the fault-tolerant market.

IBM does not say which Stratus computers will make up the System 88 line. They are expected to be available in limited quantities this year. But industry analysts believe they are the low-end Stratus FT200, built with Motorola Inc. MC68000 microprocessors, and the XA400 and XA600 mid- and high-end computers that were introduced last year and use newer 68010 virtual-memory processors.

"It is a misconception that IBM is entering the Tandem marketplace," says Omri Serlin, president of Itom International Co., a Los Altos, Calif., market research company that follows the transaction-processing business. Serlin says it's the other way around. "What's happened is that Tandem has become large enough for IBM to take notice."

Serlin says that IBM had \$17.5 billion in transaction-processing sales in 1984. Tandem's 1984 revenues were \$533 million, up 27 percent from \$418 million in 1983. "That shows you who's leading and who's coming up," says Serlin.

Despite Tandem's healthy growth,

Stratus repackages, cuts price of entry-level computer

In a move to stay competitive at the low end of the fault-tolerant computer market, Stratus Computer Inc., Marlboro, Mass., has repackaged its entry-level machine and cut the price by \$45,000.

The new FT250, a modified version of the Stratus FT200 system, comes with 8M bytes of main memory, two 143M-byte (unformatted) disk drives, a 1,600/3,200 bit-per-inch tape drive and a fault-tolerant communications subsystem.

Also included in the FT250's \$115,000 selling price are five software packages. In addition to the Stratus VOS operating system, transaction-processing facility and forms-management system, buyers receive a text-editing package and one of six languages: COBOL, FORTRAN, BASIC, C, Pascal or PL/1.

Stratus announced the FT250 within a few days of the introduction of a similarly-priced low-end machine—the NonStop EXT—by archrival Tandem Computers Inc. of Cupertino, Calif.

"What this shows is that the price war between Tandem and Stratus is reaching a new level of intensity," says Omri Serlin, president of Itom International Co., a Los Altos, Calif., research company that tracks the fault-tolerant computer market. "There is a very heated debate between them both over the relative performance of their two machines. In reality they are very comparable systems—in the range of 1 to 2 transactions per second."

Serlin adds that the FT250 is not a new Stratus machine. "It represents a pricing exercise," he says. "Stratus software has always been sold separately. Now they are offering a packaged system with the software bundled in."

The FT250 can operate in an office environment

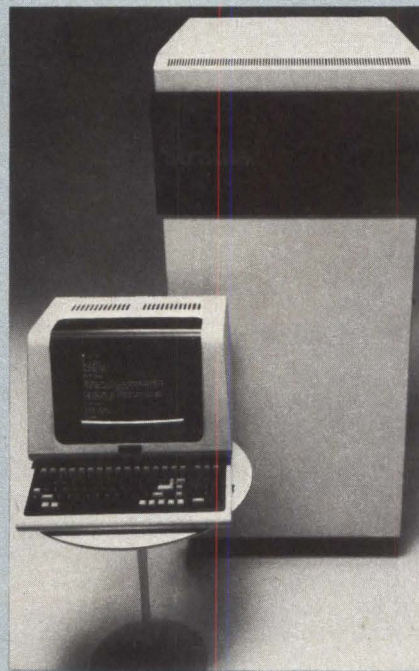

The FT250 comes bundled with five software packages, including Stratus' VOS operating system, the transaction-processing facility and the forms-management system.

and is targeted at large organizations that need distributed network nodes, according to John Morgridge, vice president of marketing for Stratus. He says the FT250 can be used for a variety of "high availability" applications, such as a system for remote warehouses and distribution centers, a communications switch or a workstation controller.

According to Stratus, the FT250 is priced 28 percent lower than a comparably configured FT200 and is available for shipment immediately.

SEE US AT
NCC
BOOTH 2132



The Universe 2400 is the first 32-bit supermicro computer built for demanding environments.

RUGGED VME PACKAGING

The tower model Universe 2400 has a steel enclosure, tough plastic outer panels, and a steel pedestal. VME-standard PC boards with screw-in mounts and gas-tight connectors help handle high temperature, vibration, and shock.

THE 32-BIT PATH TO 68020

With a 32-bit, 4KB cache and a 12.5MHz 68000 microprocessor, Universe 2400 runs with no wait states at 1.25 MIPS. And its 40MB, 32-bit VMEbus supports full 32-bit data transfers to 32-bit memories and disk channels, and provides a clean path to the 68020.

THE FIRST INDUSTRIAL STRENGTH SUPERMICRO

ISO/OSI/MAP STANDARD NETWORKING

Our 7-layer ISO-standard UniverseNet™ ties Universe systems into multi-vendor networks including Ethernet (802.3) and

the General Motors MAP network (802.4), making the 2400 an ideal Computer-Integrated Manufacturing (CIM) platform.

UNIX SYSTEM V AND REAL TIME

UNIX/System V (derived from UNIX System V under AT&T license) gives you application compatibility, plus powerful real-time extensions, contiguous files, shared data, and record/file locking.

UNDER \$6,000, QUANTITY 100

That includes 12-slot VME chassis, 512KB 32-bit RAM, 4 serial ports, 68000-based SCSI/SASI channel controller, 20MB Winchester, and floppy, in tower, rack, wall, or table mount models. For details, contact Charles River Data Systems, 983 Concord St., Framingham, MA 01701, (617) 626-1000.

CHARLES RIVER DATA SYSTEMS

UniverseNet is a trademark of Charles River Data Systems. Ethernet is a trademark of Xerox. UNIX is a trademark of AT&T.

CIRCLE NO. 15 ON INQUIRY CARD

“With the Interphase Storager,TM I can make a 5 1/4” hard disk perform like an 8” disk.”



Frank Emser
Manager Hardware Development
Paradyne Corporation

The Interphase Storager MultibusTM controller can give a 5 1/4” Winchester disk capabilities never before possible. Storager not only gets more performance from existing ST506 drives, but also supports the new ESDI and ST412HP interfaces for more power and capacity than ever before. And since Storager can control two Winchester disks, four 1/4” tapes (QIC-02), and two 3 1/2”, 5 1/4” or 8” floppies, the same controller can be used for every storage need.

Storager features 1:1 interleave, with concurrent disk and tape transfers and simultaneous disk and bus transfers for speed and high performance. And Storager’s unique “virtual buffer” architecture with UNIXTM-optimized

intelligent caching can reduce or eliminate disk rotational latency and overcome data overrun/underrun problems of FIFO-based controllers. Plus,

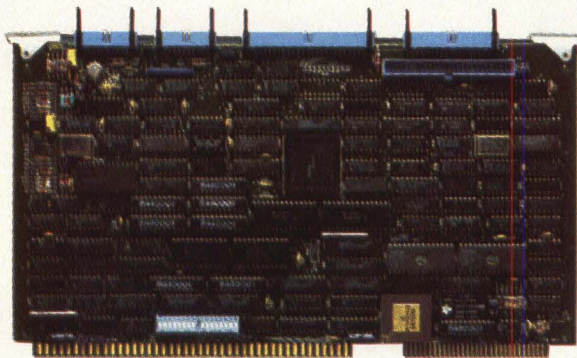

for the very first time on a controller, Storager has an *on-board* 68000 CPU.

The Storager controller is the latest product in Interphase’s

line of high-performance

Multibus controllers. Interphase also offers Multibus controllers for SMD disks, local area networks and video monitors. Plus powerful disk controllers for the IBM[®] PC. They’re all backed by a great customer support team that works full time with Interphase customers to assure that our products work the way they should — in the system.

Find out how Storager can make a 5 1/4” disk perform like an 8” disk. Call Interphase today at

(214) 350-9000.

Storager is a trademark of Interphase Corporation
Multibus is a trademark of Intel Corporation
UNIX is a trademark of Bell Laboratories
IBM is a registered trademark of International Business Machines



2925 Merrell Rd. • Dallas, TX 75229

CIRCLE NO. 16 ON INQUIRY CARD

Serlin says the company should be worried about what is happening at the low end. One problem is with Tandem's NonStop I Plus, the original NonStop computer the company refurbishes then resells for as little as \$55,000 after discounts. That machine is not completely compatible with the NonStop II (\$180,000) or the top-of-the-line NonStop TXP (\$300,000). Furthermore, the NonStop I Plus won't run a critical program—SNAX. That's Tandem's interface to IBM's Systems Network Architecture (SNA).

Analyst Peter Lowber of the Yankee Group, a Boston market research outfit, says that more than half of Tandem's customers use the fault-tolerant machines as a front end to IBM database machines for transaction processing.

Lowber says the EXT does not constitute a radical move on Tandem's part. "They're simply repackaging the same NonStop architecture and making it easier to install in smaller operational sites. But it's still good for Tandem to become more competitive with Stratus at the low-end."

The EXT architecture combines multiple parallel processors, a dual inter-processor communications bus and shared power supplies to prevent a single malfunction, or component failure, from disrupting operations.

The basic NonStop EXT comes with two processors and 4M bytes of main memory, which can be expanded to 16M bytes; two 8-inch Winchester disk drives with 168M bytes of unformatted capacity (there is room inside the cabinet for another pair of identical drives); a diagnostic service and operations processor; battery backup to protect the contents of main memory for an hour; a tape drive and controller; synchronous and asynchronous controllers; and a Tandem 6530 terminal.

The EXT comes with three Tandem software packages: the Guardian operating system, Encompass for relational database management and Expand for networking.

Tandem plans to introduce in August a two-processor expansion chassis with 4M bytes of main memory that will sell for \$100,000. That unit will

have the same disk storage capacity as the EXT unit, 16 powered I/O slots, battery backup and connections to the EXT's inter-processor bus and service and operations processor.

However, Serlin doubts that the expansion unit will catch on with customers. "By the time you add it, the price/performance [ratio] goes to pot. You might as well have put in a standard NonStop II from day one," he says.

Seeks smaller customers

Gerald L. Peterson, Tandem's vice president of product management and international sales and marketing, says the NonStop EXT will appeal more to smaller customers than do the company's other products. Tandem's NonStop II and TXP are now used by large banks, stock exchanges, financial institutions, department store chains, oil companies and automobile manufacturers.

"In banking, for instance, we see the EXT opening up a second tier of business in medium-size institutions," Peterson says. "Today we sell to the top 100 banks. The EXT will get us into the next lower level of 200 or 300 banks."

A key part of Tandem's strategy in reaching that lower tier is the company's new reseller program, which will be restricted to EXT sales only.

Under that program, Tandem will work with selected resellers who will be allowed to sell in such markets as communications, manufacturing, retailing and banking, areas now served exclusively by Tandem sales personnel.

"This will be a new channel of distribution that will allow us to get at those markets we haven't been geared up for," says Peterson. But he emphasizes that Tandem will open up the program to only a few OEMs. "We want to feel

comfortable with the solution they are offering," Peterson says, adding that Tandem will continue its present OEM program that allows resellers to market NonStop II and TXP computers in specialized markets not served by Tandem sales personnel.

Tandem faces tough job

Analyst Serlin believes that the EXT will further Tandem's strategy of cultivating "annuity accounts" by getting customers to network in a small way and grow into large systems. "They've landed some big accounts over the last couple of years that can use small remote nodes in their networks," says Serlin. "The EXT was motivated by the demands of large customers."

But Serlin and other observers say Tandem may have its work cut out for it in the transaction-processing market.

"Now that IBM has a fault-tolerant machine, it will have a negative impact on Tandem," says Serlin. "People who might have liked Stratus in the past but passed them up because of corporate credibility may look twice now that the same equipment has the IBM logo."

Exactly how similar that equipment is, IBM won't say, except to point out that some hardware and software enhancements have been made to the Stratus computers.

"Since Stratus is a competitor, both as a manufacturer and an OEM supplier, we don't want to make a point-by-point comparison of the machines," says Paul Neumann, a spokesman for IBM's Information Systems Group in Rye Brook, N.Y.

Strategic planner Held of Tandem doesn't discount the IBM threat. "We consider IBM a competitor in 99 out of 100 deals," he says. "But the System 88 is an old product. We've been competing with it in the marketplace for a couple of years." □

EPSON BUILDS PRINTER FACTORY IN CHINA

Reflecting China's new policy of opening the country to foreign capital, Epson Corp., Hirooka, Japan, is building a \$15 million factory in the Shenzhen Special Economic Zone near Hong Kong. The plant, one of the first wholly owned enterprises permitted in the zone, will be used for manufacturing printer mechanisms. The initial production capacity will begin in July, and production capacity will be 50,000 mechanisms.

Phoenix coprocessor expands IBM PC umbrella

Lori Valigra, Senior Editor

Phoenix Software Associates Ltd. should by now have embellished its IBM Corp. PC-compatible tools by supplying designs for coprocessor boards. Design licensees would make the boards, which will help companies build interim computers until they can ready a single-processor-based PC-AT-compatible. The boards also would enable companies to bring non-IBM computers under the IBM umbrella.

Under the plan, the Norwood, Mass., software company, which has completed MS-DOS ports for many major PC-compatible manufacturers, will supply the designs as part of a package including a ROM basic input/output system, GW BASIC and MS-DOS integration software, PC-DOS utilities and the choice of a coprocessor board, video board or motherboard design.

An Intel Corp. 8086 and 80286 coprocessor board, for example, will make a computer based on a Motorola Inc. MC68000, National Semiconductor Inc. 16016/32032, or Western Electric Co. 32000 processor compatible with either IBM's PC/XT or PC-AT. The board and software will let UNIX and MS-DOS operating systems, for example, run cooperatively. The coprocessor boards also can take over a host system and run PC programs without UNIX. In that case, the host

effectively serves as an I/O processor. Neil J. Colvin, Phoenix president, estimates it will cost a design licensee between \$50 and \$75 per unit to manufacture such a board.

Licensees will get a pre-manufactured, wire-wrapped board, schematics, firmware, a printed theory of operations, process-control software and all manufacturing instructions. Phoenix also will supply a recommended list of components. Colvin says the license agreement prevents the manufacturer from modifying the design without Phoenix's permission. The manufacturer can, however, freely change some aspects of the board, such as its form factor or by making it four layers instead of two.

Design customized

In this way, Phoenix maintains quality control over the board, and control over the basic design. The design is then customized. Colvin explains that Phoenix now is working on four MC68000 board designs, for which 75 percent of the software is identical. He says it takes 16 to 20 weeks to design such boards.

Colvin says that little memory is needed in the coprocessor to run the compatible software, because the substantial amount of code needed to mesh the two processors is placed in a host processor, such as an MC68000. In a UNIX-based computer, the

MC68000 runs as a multiprocessed task under the operating system, as does the PC-compatible processor.

The coprocessor boards are targeted at companies needing to add PC access to non-PC-environment products. For example, Colvin says there are about 200 graphics workstations now marketed that are based on the MC68000. If the users want to run a PC program such as Lotus Development Corp.'s popular 1-2-3 integrated package, they would add the PC mode to their machine via the board. PC processor and MC68000 modes are accessed by a software switch.

Colvin says Phoenix is adding value to existing workstations by adding PC capability. He says customers generally are happy with their MC68000-based computers. He claims that while many National Semiconductor processor-based machines are about six months away from introduction, "those manufacturers already are looking at PC compatibility as an add-on [feature]."

For so-called "friendly" (i.e., Intel-processor) environments, Phoenix is offering PC-compatible manufacturers a short-term solution until they can design and produce a PC-AT-compatible machine that doesn't have a dual personality. The price for Phoenix's compatibility package in a hostile, or non-Intel-processor, environment is about \$1 million, while in a friendly environment it would be \$700,000 to \$750,000.

Retail version available

Phoenix will sell some of the boards on a retail basis through its Phoenix Computer Products Corp. affiliate. The first board, called Pfaster286, was scheduled for introduction last month. While this board is not intended to provide complete PC-AT-compatibility, it triples the speed of MS-DOS 2.0, 2.1 or 3.0 on an IBM PC or PC/XT, claims Phoenix.

Pfaster286 includes a PC-AT ROM (MMS, March, Page 34), an 80286 CPU, a socket for an optional 80287 math coprocessor, 1M byte of RAM (expandable to 2M bytes using 256K bit RAM chips), 16K bytes of electron-

HOW PFASTER286 WORKS

boot up PC
coprocessor mode

80286

high-speed PC/XT-AT operation

80286 performs high-speed memory and processing tasks, the host system's 8088 performs I/O tasks, optional 80287 handles math functions

boot up PC
native mode

8088

standard PC/XT operation

8088 performs all system functions, optional 8087 handles math functions

Source: Phoenix Software Associates Ltd.

With Phoenix's Pfaster286 coprocessor board installed, a host system's 8088 chip can perform I/O tasks for the 80286, or function as the CPU.

Norman B. Petersen
Senior Vice President
Fujitsu America, Inc.

“At last there’s a high-performance 5¼” disk drive with Fujitsu quality. From Fujitsu, of course.”

Finally there’s a 5¼” disk drive that offers you the kind of high-performance features and quality components generally found only in larger, more expensive drives.

It’s from Fujitsu, of course. We worked very hard to perfect this drive, so we could offer you a product that is competitive in price, yet still superior in quality.

So we designed it with proven technology, using standard ferrite heads and oxide recording media.

Then we proved it in the field. And today, based on actual operating experience, we now back all our 5¼” drives with a specified MTBF of more than 20,000 power-on hours.

So you can design them into your system with complete confidence.

You’ll get a top-notch performer, too. With from 31 to 86 megabytes of capacity, 33 millisecond average positioning time, and a 625 kilobyte-per-second transfer rate!

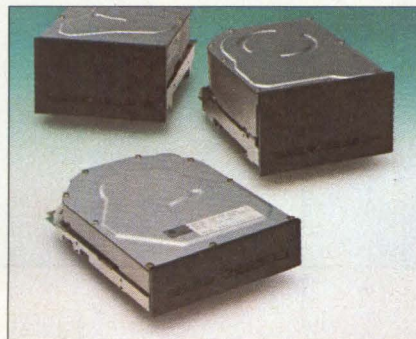

MODEL	M2241	M2242	M2243
CAPACITY (MB) Unformatted	31	55	86
AVERAGE POSITIONING TIME (msec)	33	33	33
TRANSFER RATE (KB/sec)	625	625	625
INTERFACE	ST506/ SA4000	ST506/ SA4000	ST506/ SA4000
POSITIONING METHOD	Rotary Voice Coil	Rotary Voice Coil	Rotary Voice Coil

We also offer a full line of stepper-motor, standard performance 5¼” drives. With capacities from 13.3 to 26 megabytes. Plus half-high models with 6.6 and 13.3 megabyte capacities.

To assure you prompt delivery, we have just completed a new plant, adding 220,000 square feet to our 5¼” manufacturing capability.

So give us a call today, at (408) 946-8777. Or write Fujitsu America, Inc., Storage Products Division, 3055 Orchard Drive, San Jose, CA 95134. We’re your one-stop, full-line disk drive supplier. We’ve got the sizes and the capacities. We’ve got the performance. We’ve got field-proven reliability.

And we can deliver.

Fujitsu Storage Products. Maximum Performance. Maximum Quality.

FUJITSU AMERICA, INC.



How we improved Structured Query Language.

Actually, we didn't change a thing.

We just combined it with the best relational database management system.

Introducing INFORMIX®SQL.

It runs on either UNIX™ or MS™-DOS operating systems. And now with IBM's SQL

as part of the program, you can ask more of your database. Using the emerging industry-standard query language.

To make your job easier, INFORMIX-SQL comes with the most complete set of application building tools. Including a full report

writer and screen generator. Plus a family of companion products that all work together.

Like our embedded SQLs for C and COBOL. So you can easily link your programs with ours. File-it!™ our easy-to-use

file manager. And C-ISAM™, the de facto standard ISAM for UNIX. It's built into all our products, but you can buy it separately.

And when you choose RDS, you'll be in the company of some other good companies. Computer manufacturers including AT&T, Northern Telecom, Altos and over 60 others. And major corporations like Anheuser Busch, First National Bank of Chicago and Pacific Bell.

Which makes sense. After all, only RDS offers a family of products that work so well together. As well as with so many industry standards.

So call us for a demo, a manual and a copy of our Independent Software Vendor Catalog. Software vendors be sure to ask about our new "Hooks" software integration program. Our number: 415/424-1300.

Or write RDS, 2471 East Bayshore Road, Palo Alto, CA 94303.

And we'll show you how we took a good idea and made it better.



RELATIONAL DATABASE SYSTEMS, INC.



CIRCLE NO. 18 ON INQUIRY CARD

EFFICIENCY EXPERT.

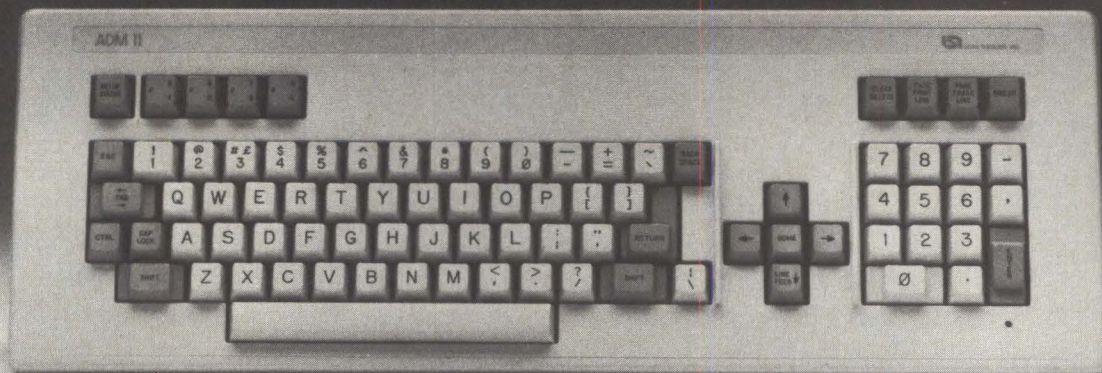

With the ADM™ 11 video display terminal, increased efficiency is right at your finger tips.

The ADM 11 has been ergonomically designed to give operators optimum comfort and convenience. The result is fewer mistakes and increased efficiency.

As you can see, the keyboard is uncluttered and spacious, with logical key groupings. The keys are sculptured to make data entry faster and easier. Plus, the cursor keys are arranged in a "cross" pattern that's easy to learn and use. And the fifteen programmable functions (function and edit keys) save time and eliminate keystrokes.

The ADM 11 is also an expert at providing both reliability and versatility, and it's compatible with ADDS Viewpoint® and Regent® 25, Hazeltine 1400, 1420 and 1500 and DEC VT52™ terminals.

For complete information on how the ADM 11 can be your efficiency expert, call us at **800-LEAR-DPD (800-532-7373)**.

 **LEAR SIEGLER, INC.**
DATA PRODUCTS DIVISION

901 E. Ball Road, Anaheim, CA 92805, (714) 778-3500

Viewpoint and Regent are registered Trademarks of Applied Digital Data Systems, Inc. VT52 is a registered Trademark of Digital Equipment Corporation.
© 1985 Lear Siegler, Inc.

See us at NCC Booth #5162

CIRCLE NO. 19 ON INQUIRY CARD

ically programmable ROM (expandable to 256K bytes) and support for eight levels of interrupts and four direct-memory access channels. The board fits into any long slot in a computer's chassis. Phoenix says Pfaster286 can be used with most programs written for the Intel 8088. But some programs may not run at the same speed and may encounter problems in critical timing loops if run at 80286 speeds. The board is priced at \$2,395.

The coprocessor scheme had its roots in a portable computer, the Ottona Corp. Attaché, that Phoenix helped make PC-compatible three years ago. The Attaché bears little resemblance to IBM's PC, having a different processor, keyboard and monitor. Phoenix created a coprocessor board and software to essentially trick the system into operating like a PC.

At the same time it announced its coprocessor design strategy, Phoenix

introduced a design for an advanced video board. This product takes low-end IBM video compatibility (320-by-200-dot resolution) and meshes it with a high-resolution 28-MHz monitor. Colvin says this gives users a high resolution picture (640 by 400 dots) when running low-resolution software, a capability not offered on IBM's basic PC. The board is said to be compatible with the Hercules monochrome graphics and Tecmar Graphics Master graphics add-in cards for the IBM PC. □

Lotus-Cullinet alliance plans micro-mainframe link

Lori Valigra, Senior Editor

Two software companies dominating opposite ends of the computer market have met halfway to bridge the gap between microcomputers and mainframes.

Lotus Development Corp., Cambridge, Mass., and Cullinet Software Inc., Westwood, Mass., are allying to produce programs connecting Lotus' Symphony and 1-2-3 personal comput-

er software to Cullinet's database software running on IBM Corp. and compatible mainframes. Lotus' Symphony Link, which will work with a 3278 communications board, will be available first. Cullinet's Symphony Link, the Symphony program, and the 3278 board to operate, will follow. The forthcoming software will let personal computer and mainframe owners transfer information between the two

types of processors.

The alliance "is a move by both [companies] to keep them from losing sales," says Paul Cabbage, senior industry analyst for the Software Information Service at Dataquest Inc., a San Jose, Calif., market research operation. Cabbage suspects Cullinet has been losing some Fortune 1,000 business because its mainframe programs do not have a Symphony or 1-2-3 interface. He says 1-2-3 is the most prevalent integrated product in Fortune 1,000 companies, and estimates that, by the end of last year, Lotus had installed 675,000 1-2-3 programs and about 90,000 Symphony packages.

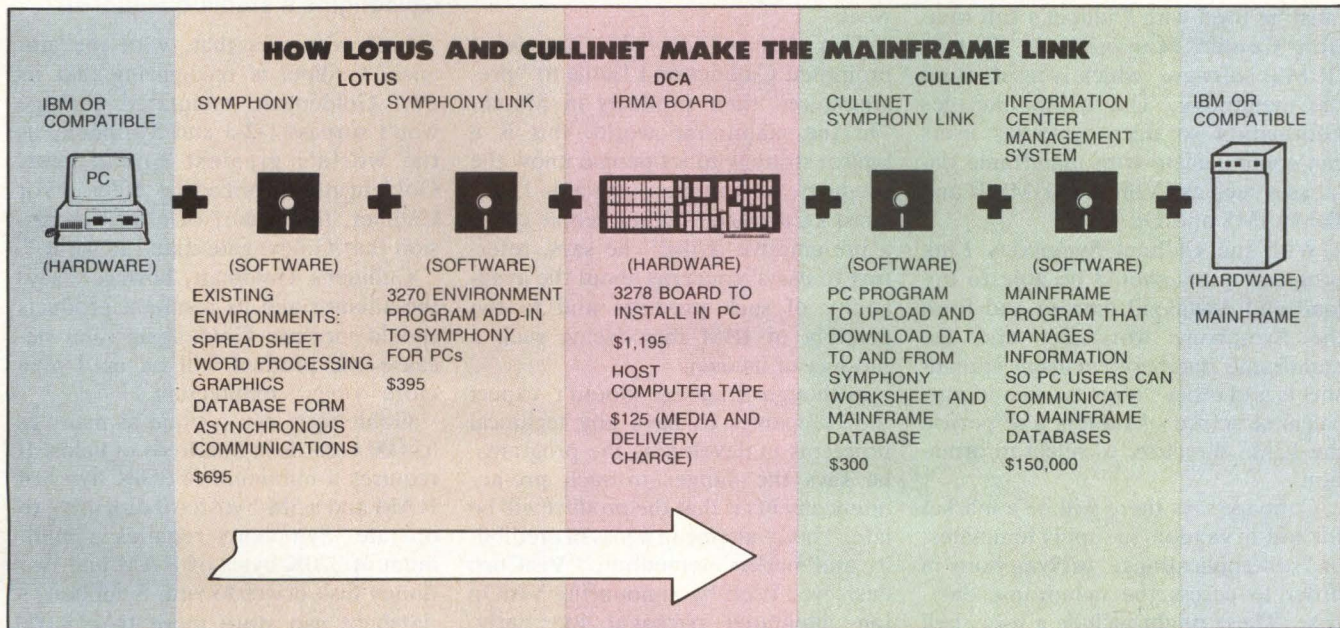

Tying an IBM PC or lookalike to an IBM mainframe or compatible requires two Lotus programs, a DCA 3278 communications board, one PC and a mainframe software package from Cullinet.

What Lotus gains from Cullinet is the mainframe link that has become critical to users in such large companies. "Lotus has recognized that microcomputer software managers without a micro-to-mainframe connection won't make it in the long run," Cabbage contends. Additionally, he points out that Symphony has not been as big a hit as 1-2-3 and the alliance may help push Symphony into the large accounts. "This is a defensive move to keep them from being locked out of bids" made by large corporations, he says.

Robert Lefkowitz, an analyst with the Cupertino, Calif., market research company, Infocorp, agrees. "This gives Lotus a way into large corporations' MIS (management information systems) departments," says Lefkowitz, asserting that Cullinet will promote Symphony through the company's direct sales force.

Cullinet adds own products

While the symbiotic relationship calls for the duo to develop Symphony Link packages to allow Symphony users to access mainframes, Cullinet also is developing the Cullinet Universal Link, to let 1-2-3 users communicate with a mainframe. Each product must be used with Cullinet's Information Center Management System (ICMS) software, which is resident on the mainframe. The ICMS manages information so microcomputer users can communicate with mainframe databases such as Cullinet's IDMS/R and IBM's IMS and DL/1.

With the Cullinet Symphony Link program, users should be able to upload and download data to and from the Symphony worksheet and the mainframe database, manage spreadsheets and other "objects" in a hierarchical structure of folders and peruse the ICMS directory to select information.

Cabbage says there will be a market for add-in vendors to supply templates, or "sub-applications," to Symphony in order to access the mainframe database. These might include a user shell for financial applications.

The Cullinet products, however,

aren't expected to be available to users until the fourth quarter of this year and then only in beta-test versions. Cullinet's Universal Link and Symphony Link each will be priced at \$300. ICMS is available now at \$150,000 for a site license fee. Lotus' Symphony Link should be available by midsummer, along with the 3278 board for Symphony. That board is the result of a joint venture between Lotus and Digital Communications Associates Inc. (DCA), Norcross, Ga. The board is priced at \$1,195, and the software is priced at \$395.

Lefkowitz says that as a rule of thumb, users are willing to buy a PC/3270-type mainframe link for double or triple what they would pay for a 3270 terminal alone. Alexander Crosett, manager of communications marketing at Lotus, says the price of the Cullinet-Lotus mainframe link will equal a 3270's price, or about \$4,500. (This assumes that the \$150,000 ICMS is already in place.)

Cullinet president Robert N. Goldman expects the joint effort to provide hundreds of thousands of personal computer users with access to IBM mainframes. Jim Manzi, president of Lotus, says customers ask about mainframe connections three to four times a week.

This demand may be just what prompted Cullinet and Lotus to "pre-announce" their products in March. "In the mainframe world, this is a typical strategy to let people know the products are coming," explains Dataquest's Cabbage. "Other people call it a pre-emptive strike," he says, referring to users' concerns about the availability of such products and to the possibility of IBM introducing such a product of its own.

Although Cabbage doesn't expect the companies to have any technical problems in developing the programs, he says the danger in such pre-announcements is that the product will be late. This could mean a loss of credibility and market momentum. "VisiCorp destroyed itself by announcing VisiOn [an integrated package] too early. There's some real peril [in doing that]," he cautions.

Bringing mainframe and microcomputer orientations together may prove the highest hurdle. "The difficulties will be from coordinating two different companies and philosophies," says Cabbage.

The main problem with the alliance may lie in the dual origination of the products, says Lefkowitz. He says MIS managers like to buy products from one vendor to get common sales support and service. At press time, Cullinet and Lotus intended to sell their products independently. Lotus' Crosett says his company wants to sell the products as a group, so the sales situation might change. For now, Cullinet plans to sell through its direct sales force and Lotus will sell through its authorized retailers. The 3278 board will be available from DCA. "It gets hairy, if the MIS director buys hundreds of thousands of products" from different vendors, he explains. "They [Cullinet and Lotus] will need some merging of the sales effort, if this is to be successful. I don't know what form that will take."

He expects the products to provide Cullinet and Lotus with 10 percent to 15 percent in added sales, because these are ancillary products.

Goldengate's status questioned

Lefkowitz says that, with the alliance, Cullinet is recognizing that its own Goldengate integrated package won't surpass 1-2-3 and Symphony as the world's greatest spreadsheet. Goldengate is priced at \$795. "For Cullinet, this is sort of a tacit admission that Goldengate didn't make it."

Cullinet's Goldman, however, says the alliance and its resultant products should increase Goldengate sales because the product will be used in a more "open" architecture.

Goldengate can contain as many as 65,000 records in hundreds of fields. It requires a minimum of 320K bytes of RAM and a 5M-byte hard disk drive to operate. Symphony requires a minimum of 320K bytes of RAM and two floppy disk drives to run. Symphony's database can store more than 8,000 records in as many as 256 fields. Its price is \$695. □

Torn between a DEC® VT220 and an ERGO® 320?

Permit us to confuse you with the facts.

Compatibility

The Micro-Term ERGO 320 is fully compatible with the DEC VT220 and emulates all DEC functions.

Features

Other popular ERGO 320 features not found on a VT220: User-programmable compose key • User-programmable function keys • Function keys in VT100 mode • Flashing LEDs indicating Xoff has been enacted • Superior 132-column clarity • Bi-directional printer port • Erase or save 80/132 screen • Variable-speed smooth scroll • Choice of smooth- or jump-scroll without entering set-up mode • Addressable 25th status line • Low power consumption • Easy access to on/off and brightness controls • **A full one-year warranty.**



Design

The ERGO 320 is ergonomically designed and housed in an attractive, compact case with an adjustable monitor and smaller footprint than the DEC VT220. The detached, low-profile keyboard, is shorter than the DEC VT220 keyboard, and has an easy-tilt adjustment to provide ease of use for all users.

Graphics

Upgradability. The ERGO 320 can accept an optional graphics board (\$745) which will perform all Plot-10 and ReGIS functions. The graphics board, which turns an ERGO 320 into an ERGO 340, can be added to existing ERGO 320s. The small footprint is maintained when adding graphics to an ERGO 320 but must be forfeited when purchasing a VT240. **Fast, too.** In addition, our graphics offers significant speed advantages over a VT240—as much as **seven times faster.** (See an actual comparison above.)

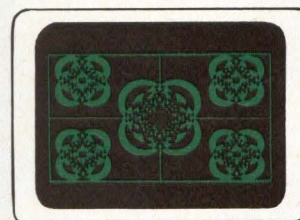

ERGO 340
Elapsed Run Time: 11.0 sec.

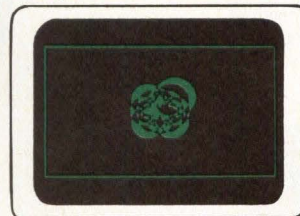

DEC VT240
Elapsed Run Time: 11.0 sec.

Price

Micro-Term prides itself on designing and manufacturing innovative products, with **complete** emulations and aggressive pricing. At a list price of only **\$795**, the ERGO 320 with all the additional features and upgradability should take the confusion out of your decision.

\$795

MICRO-TERM

Terminals are our only product, and we put more into them.

Call or Write: MICRO-TERM, INC., 512 Rudder Road, Fenton (St. Louis County), Missouri 63026
(314) 343-6515, TWX: 9107601662, MICROTERM, STL.

On-site service available at over 450 locations through Western Union

DEC VT220 and DEC VT240 are registered trademarks of Digital Equipment Corporation.

CIRCLE NO. 20 ON INQUIRY CARD



UNIX

It's a big word these days. And no one has a bigger commitment to it than Apollo. In fact, we've raised the UNIX™ standard to new heights.

We're the first major computer company to implement both AT&T System V and Berkeley 4.2 on a professional worksta-

tion. So you can run either standard or both simultaneously.

More important, we're the only company that gives you UNIX in a powerful, distributed processing environment. One that features 32-bit dedicated workstations, high resolution graphics, and a high-speed local area

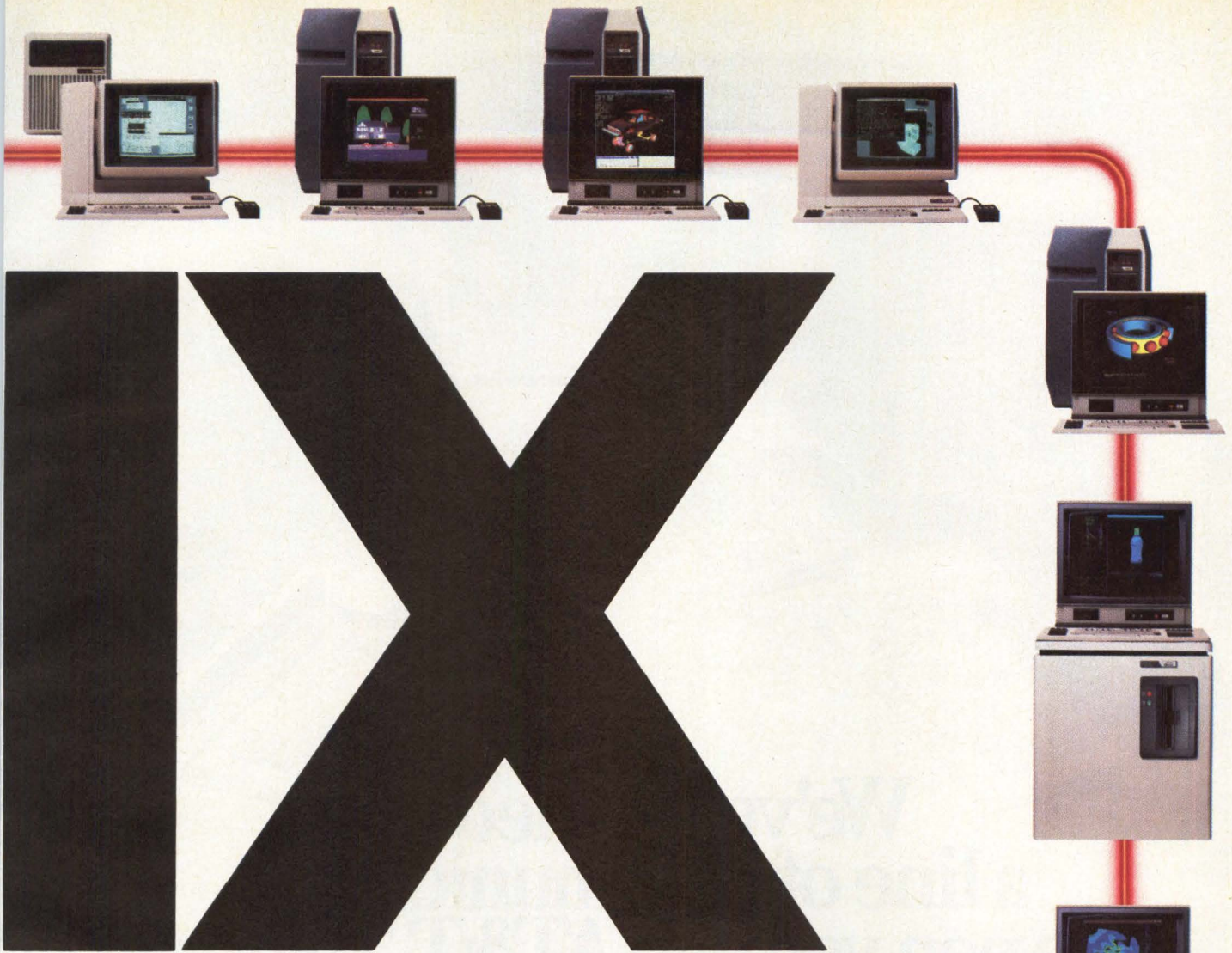

network that lets you transparently share information and resources.

Today, the right UNIX standard is a choice of standards. For a demonstration of a standard that's anything but ordinary, call (617) 256-6600 x4419. Or write Apollo, 330 Billerica Rd., Chelmsford, MA 01824, MS29.

apollo

UNIX is a trademark of Bell Telephone Laboratories, Inc.

CIRCLE NO. 21 ON INQUIRY CARD



We've opened up a line of communication between you and AT&T Teletype.

AT&T Teletype Corporation has been an industry leader in the communications business for 77 years now. And their present family of office automation systems, work stations, and intelligent terminals continues that leadership tradition.

At Kierulff, a distribution leader since 1931.

We're delivering the entire AT&T Teletype Corporation family, from over 30 stocking locations across the country. Right to your doorstep, right on time.

Take the 5400 asynchronous terminal family. Featuring true cost-effectiveness, and including the 5425 with buffered keyboard display for UNIX* and DEC VT102**compatibility.

Or choose the UNIX-based 5620 Dot Mapped Display, with advanced windowing capabilities and mouse control.

The 5310/5320 line of impact dot matrix printers and keyboard printer terminals is also a good choice, with features and options galore.

Need a heavy duty line printer? Consider the T300. With RS232C interface, and Centronics and Dataproducts compatibility.

And for BSC and SNA/SDLC networks, there's the 5540 3270-compatible terminal. With controllers for up to 32 devices.

We have them all at Kierulff. Along with a total systems capability in virtually every application area and performance range. For board-level computers, interface boards, mass storage peripherals and subsystems, terminals and printers, or software development tools, simply dial 1-800-FOR PROS to reach the Kierulff office nearest you.

Our lines of communication are always open.

 **KIERULFF ELECTRONICS**
A DIVISION OF DUCOMMUN INCORPORATED
10824 Hope Street, Cypress, CA 90630
1-800-FOR PROS

*UNIX is a trademark of AT&T Bell Laboratories.
**VT102 is a trademark of Digital Equipment Corporation.

CIRCLE NO. 22 ON INQUIRY CARD

First Japanese Comdex gives glimpse of progress

Charles Hintermeister
Taiwan Correspondent

Although Comdex Japan '85 may not open any doors for U.S. computer companies, it did give American visitors an opportunity to assess Japan's progress in the business and personal computing fields.

The chief purpose of holding Japan's first Comdex, according to Sheldon G. Adelson, president of the Interface Group of Needham, Mass., which sponsored the show, was to help U.S. computer companies penetrate the lucrative Japanese market. But Comdex Japan '85 turned out to be a primarily Japanese show. About three-quarters of the more than 200 exhibitors were Japanese, as were most of the visitors. A small number of companies from Southeast Asia, Canada, Sweden and West Germany were also present.

About 40,000 people visited 700 booths in 150,000 square feet of space at Tokyo's Harumi Exhibition Center during the show's three days, March 26-28. The exhibits-only admission fee of \$25 did not seem to deter many Japanese, who are accustomed to attending shows free, according to a spokesman for the Interface Group. However, \$80-per-day conference sessions were, for the most part, sparsely attended.

Dominated by Japanese

While IBM-Japan, AT&T International and a few other heavyweight U.S. companies put on prominent exhibits, the companies were somewhat

overshadowed by displays put on by Brother International, Citizen Watch Co., C. Itoh Electronics Ltd., Epson Corp., NEC Corp., Sharp Electronics Corp. and Sony Corp., all Japanese.

Not surprisingly, the overall product emphasis was on what the Japanese are best known for—high-quality peripherals for the OEM market. There was particular stress on hard disk drives, high-capacity minifloppy, and micro-floppy drives, terminals and printers in staggering array. Other major product areas at the show were 16-bit laptop computers, local area networks and software.

AT&T UNIX PC makes a splash

Among the U.S. companies at the show, AT&T International's booth drew some of the largest crowds. The exhibit, which included the 3B series of computers, UNIX software, digital switching applications and a videotex system, centered around the new AT&T UNIX PC, which was announced worldwide as Comdex Japan began.

The UNIX PC will be distributed in Japan by Ricoh Co. Ltd. and probably by Olivetti-Japan, says an AT&T spokesman. AT&T has already concluded an agreement with Ricoh to distribute AT&T's 3B series of computers in Japan. AT&T last year began purchasing high-speed facsimile copiers from Ricoh.

Another of the UNIX-based systems on display at the show was the 8120DX from Sharp. Running the Motorola Inc. MC68000 microprocessor, clocked



Sheldon G. Adelson, president of the Interface Group, which sponsored Comdex Japan, says the show was held in Japan to help U.S. companies penetrate the Japanese market.

at 10 MHz, the 8120DX provides 768K bytes of RAM, which can be expanded to 4M bytes. On-board storage devices include a 1M-byte floppy disk drive and a 5/4-inch hard disk drive, available in capacities of 10M, 20M, 40M or 60M bytes. The monitor displays 640 by 475 dots in text or graphic mode. The Sharp 8120DX retails in Japan for about \$8,600.

Hard disks abound

Japan's major players in hard disk manufacture all put on large exhibitions. Teac announced a half-height, 25M-byte, hard disk drive it says will go into production by this summer, and Fujitsu Ltd. displayed two 5/4-inch, half-height, hard disk drives, with unformatted storage capacities of 13.3M and 26.7M bytes. Fujitsu's M2233AH/BH and M2235AH/BH, which were unveiled at the show, will be available by the end of this year, according to a Fujitsu spokesman. Fujitsu AH models have an ST412 interface, while BH types use an SA4000 interface. The average posi-

tioning time for each model is 95 msec, and the data-transfer rate is 625K bytes per second. Fujitsu also displayed its 14-inch, five-platter, hard disk drive with an unformatted storage capacity of 671M bytes. Introduced in December 1984, the unit has an average positioning time of 27 msec and an OEM sample price of \$11,500.

Nippon Peripherals Ltd. introduced three models to its line of hard disk drives. Nippon displayed a 3½-inch model—produced in single- or dual-platter versions—a 5¼-inch, 26M-byte, half-height drive and a 5¼-inch, 85M-byte drive. Each will be commercially available by this summer, according to a Nippon spokesman.

On the software side, a new relational database language called Database IV was introduced by Intelligence & Knowledge Engineering Inc. of Osaka, Japan. It is said to be capable of simultaneously processing nine files and runs under MS-DOS. Database IV is slated to be priced at \$495 when it becomes available later this year. There is no relation between Database IV and dBASE II or with its maker, Ashton-Tate.

Telemedia Inc., part of the Computer Technology Group of Chicago, promoted its UNIX and C language training courses at the show. The company offers a variety of seminars and video-based training courses, which it believes have strong potential in Japan. According to a spokeswoman for Telemedia, UNIX training in Japan, whether in Japanese or English, is fairly backward. She says that considerable interest in the course was expressed by visitors to the show.

Nine-pound computer displayed

A number of laptop computers from both U.S. and Japanese vendors were introduced. The Ampere WS-1, produced by Ampere Inc., Tokyo, will be handled in the United States by Work Space Computer Inc., of Torrance, Calif. While most of the other laptops on display are MS-DOS-based, the Ampere system uses the multitasking BIG.DOS operating system and the APL programming language. The nine-pound unit runs on Motorola's



Dr. Atsuyoshi Ouchi, vice chairman of NEC Corp., says Japanese trade barriers must be observed by the Japanese as well as by foreigners.

MC68000 microprocessor, clocked at 8 MHz, and provides 128K bytes of ROM and 64K bytes of CMOS RAM, expandable to 448K bytes. A built-in microcassette for data, program or voice storage is provided, and an external 3½-inch, battery-powered micro-floppy disk drive is optional.

The bit-mapped, liquid-crystal screen displays 25 lines by 80 columns. The keyboard features 70 keys in an APL/ASCII layout and includes eight programmable function keys. The system's various interfaces include two RS232C serial ports, one with a built-in, 300-baud modem; a Centronics printer port; an external floppy or hard disk drive interface; an external system bus interface; a standard telephone modem connector; three slots for RAM, ROM or EPROM cartridges; an internal slot for a 192K-byte, static RAM card; and microphone and speaker jacks.

The Ampere WS-1, configured with 64K bytes of CMOS RAM, sells for \$1,995. Samples should be available now. Volume production is expected to begin in July.

Most of the U.S. exhibitors at Comdex Japan said they are confident that they will be able to make their mark in the Japanese business-computing market. Asked whether Japan's trade barriers would seriously hinder the successful promotion of U.S. computer products in Japan, the Interface Group chairman Adelson asserted that it was "quite possible" that it would. He maintained that Japan's huge trade surplus with the United States makes it "quite clear to us that the Japanese have to go overboard if they want to continue trading with the United States. They have to go out of their way to bring U.S. products to Japan." Adelson said that Comdex Japan had many prominent members of the Japanese computer industry on its advisory board.

One member, Dr. Atsuyoshi Ouchi, vice chairman and representative director of NEC Corp., downplays the barriers. He says these barriers—endless red tape, labyrinthine customs procedures, etc.—must be observed by Japanese as well as by foreign companies, and the barriers do not in themselves favor either group. He points out, however, that U.S. companies trying to sell their products in Japan have often not taken the time to learn exactly what the Japanese want, or what would be the best way to sell to them. "For example," he says, "when Japanese companies export automobiles to the United States, they naturally put the steering wheel on the left side. But when U.S. car makers export cars to Japan, they don't place the steering wheel on the right side." □

TECHNOLOGY DRAWS BULK OF VENTURE CAPITAL

Venture capitalists still have large amounts of money to invest. Following the 1983 explosion of new capital commitments to a record \$3.4 billion, 101 independent, private venture funds raised \$3.2 billion in 1984, according to the *Venture Capital Journal*, Wellesley Hills, Mass. Both figures compare favorably with the \$1.4 billion raised in 1982. Most of the 1984 monies come from pension funds, individual or family investments and insurance companies. Venture capitalists are expected to invest the bulk of their funds in technology-related companies. Californian investors got the most in commitments with \$1.2 billion; next were New York (\$649 million) and Massachusetts (\$481 million).

**Surprise! ONYX™ is the
value leader in 68010
OEM systems. (Not NCR.
Not Convergent.)**

**Start with a major price/
performance advantage. Surprised?**

If you thought NCR — or anyone else — offered the best performance value on multi-user UNIX™-based 68010 OEM computer systems — *It's time to look at Onyx:* Onyx systems let you give your customers added value, quality and reliability at a highly competitive cost per user. Take that pure price/value advantage, add Onyx systems' built-in growth path, and you've got tremendous selling edge. **No surprises from Onyx when it comes to performance. Or delivery. Or support. You get results.** Onyx was the first to put UNIX on a microcomputer. In the last five years, we've installed nearly 10,000 UNIX systems. And in our industry, experience is the name of the game. It makes sense to make Onyx your success partner: Our commitment to product quality, delivery and support goes back further than some companies' entire corporate histories. No surprises: Just experience. Results. And quality. **Onyx results mean you get your product to market faster.** If you've been dealing with the others, you'll be pleasantly surprised at how easy it is to work with Onyx: Configure Onyx systems with the hardware and interface specifications you need, whether it's the Onyx 6810 with UNIX or our 80186-based Onyx 6001 with XENIX.™ Onyx software products, tools and technical engineering support can help get your product to market faster. Then see how simple it is to sell customers optimum value in an expandable, serviceable, solidly-designed Onyx business system. *No surprise, then, that it's time to look at Onyx.*



CIRCLE NO. 23 ON INQUIRY CARD

Onyx Systems, Inc.
25 East Trimble Road
San Jose, CA 95131-1162

Onyx Systems (Europe) Limited
7 Fairmile
Henley-on-Thames
Oxfordshire RG9 2JR England
Telephone: (0491) 571100
Telex: 847282 ONYX

Trademarks:
Onyx — Onyx Systems, Inc.;
UNIX — AT&T Bell Laboratories;
XENIX — Microsoft Corporation.

The next step for OEMs

who want results:

Call 800-538-6815

In CA: 408-946-6330

ONYX

OVERHEARD OVERSEAS

British group challenges Intel's OpenNet standard

Denise Danks
European Contributor

While Intel Corp. was announcing its OpenNet strategy for microcomputer local area networks in March—with the blessing of IBM Corp. and Microsoft Corp.—the British Microcomputer Manufacturers Group (BMMG), Buntingford, England, was revealing plans to create a standard for economical LANs.

David Fraser, managing director of the British subsidiary of Microsoft, has already criticized the BMMG scheme, arguing that it is futile to fly in the face of IBM and Microsoft.

BMMG supporters, however, see the proposal not so much as a head-on OpenNet competitor but as a less expensive, more efficient alternative and also as one more means of preventing IBM domination in the LAN market.

Despite the controversy, some important microcomputer vendors are supporting the BMMG move. Apart from up to 10 BMMG members who build networks, significant non-BMMG members backing the initiative are Applied Computer Techniques Plc., Birmingham, England, Britain's largest microcomputer manufacturer, and Digital Microsystems Ltd., Reading, England. Digital Microsystems manufactures Hinet, the leading European LAN product.

The LAN standard proposals are a result of a feasibility study by Dr. Christopher Shelton of BMMG member Shelton Systems Ltd., London. Shelton worked with the Information Technology Standards Unit of Britain's Department of Industry. The BMMG is now seeking government endorsement and funding of £500,000 (about \$625,000) to have off-the-shelf components available for network manufacturers within a year.

Computer consultant and director general of the BMMG, David Broad, says the feasibility study was commis-

sioned because manufacturers were concerned over the glut of microcomputer designs on the market. Their view was that the lack of common standards in the market for 1M-bit-per-second (bps) to 2M-bps LANs and confusion over incompatible designs would discourage potential users and undermine the credibility of microcomputer manufacturers.

Patrick Johnstone, marketing director at Digital Microsystems, admits that his company joined BMMG's push for standards because it was designing a higher speed version of Hinet, a baseband LAN with a speed of 500K bps. The advent of British government funding was good timing, he concedes. More generally speaking, Johnstone says, "The whole objective is to get the manufacturing cost of a standard connection below that of Ethernet. A standard for electrical connection is highly desirable for large customers, particularly [those with] government contracts."

BMMG's Broad says another motivation behind the push for a standard is the real threat of IBM—as a single, dominant supplier—producing its own design and controlling the LAN market.

And, in Western Europe, this market is growing fast. According to a Eurocast report from IDC Europa Ltd., the number of installed baseband LANs was 21,400 in 1984, up from 2,330 in 1982. The market should grow annually by 72 percent until 1990, according to the report.

The BMMG initiative is all the more significant because Britain has 58 percent of the total installed broadband and baseband LANs. France and West Germany have 10 percent and 9 percent, respectively. Britain's baseband installed base should grow by 54 percent annually until 1990, predicts the report. France's installed base should experience an 89 percent annual growth rate, while West Germany's

base should increase 81 percent a year.

While BMMG is initially proposing DR Net—networking software from Digital Research Inc., Pacific Grove, Calif.—running under Concurrent DOS, later versions will adopt open systems interconnection (OSI) protocols and support other operating systems, including MS-DOS and UNIX.

The proposed LAN would connect at least 64 stations in bus or star networks using carrier sense multiple access or token passing over coaxial cable at 250K to 2M bps. The hardware required will cost LAN manufacturers between \$12 and \$40 per connection and will be available in a year.

The BMMG proposal differs from OpenNet in that it excludes Ethernet, using DR Net instead. Shelton does not see the use of DR Net causing a clash of interests with users of OpenNet. "DR Net is a temporary vehicle [designed] to allow us to use Concurrent DOS and get the system working. Whether we'll integrate DR Net at the full transport or link layer of OSI we don't yet know," Shelton admits. "But, we will seek to decrease the use of DR Net and interface OSI straight into Concurrent DOS, MS-DOS, UNIX," or other operating systems.

Johnstone agrees. "We want an efficient, low-cost physical and software structure users will want. DR Net is the short term. It has several advantages over MS Net [Microsoft Networks] because under Concurrent DOS you can have PC-DOS emulation and you can run IBM software and a multiuser network. But it is only the first phase. It doesn't mean we can't go for the full OSI seven layers."

OpenNet is claimed to be a full definition of the International Standards Organization's OSI seven-layer communications model. Intel has adapted Ethernet chips and software so they not only support the lower levels of the OSI model but also the higher level network applications such as sharing hard-disk memory and electronic mail. Intel is initially supporting its own real-time operating system, iRMX, and Microsoft's XENIX and MS-DOS.

LETTER QUALITY
AND
COLOR GRAPHIC
PRINTER

JDL-750

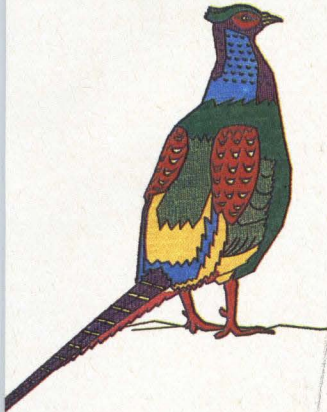

JDL INC

The target area beneath the wafer position is 200mm in diameter and 250mm in diameter for a 125mm wafer; both target sizes up to 2.5mm thick. The target is metal-bonded to a wafer through which a bath of cooling water flows. The magnet is exposed. This simplifies changing the target without a cooling water connection.

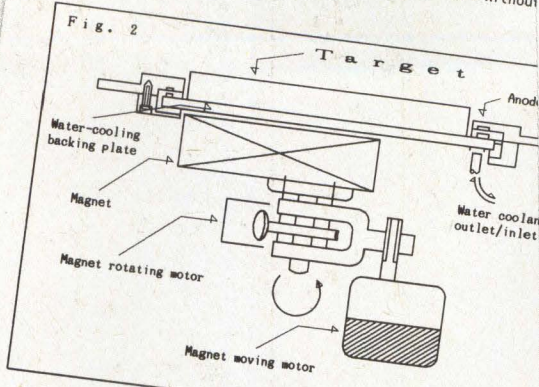

The exposed magnet position allows for greater flexibility in target shape and size, since the magnet is not near the cooling water path and is not subject to rust. The target uses the magnetic field technology patented by Smith to raise the efficiency of the target in the path of the magnetic field that flows

To All District Managers:

Congratulations, for the first six months of this year we have exceeded projected by a healthy margin.

With the exception of an expected dip in March, monthly sales are continuing to increase. Given our current growth rate potential, we now expect to exceed sales of \$1,500,000 year end.

The bar graph below dramatically indicates our revenue and the improvement over projected sales. The pie chart shows the revenue generated by district.

% Revenue (by district)

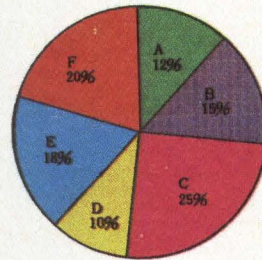

Revenues (000)

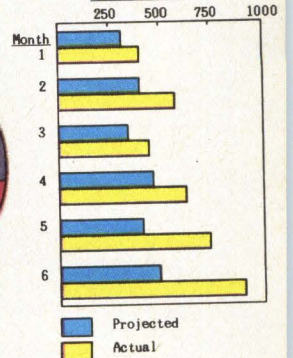

Evaluating color impact printers? Call for the samples that make our competition pale.

What customers are saying. Customers who have seen these print samples for themselves call our dot matrix graphics CAD-quality. The kind that reproduces the finest detail with superb accuracy and registration. The JDL-750's color graphics are so vivid, images seem to jump off the page. Add to that letter quality printing, and font versatility that surpass fully-formed character printers. Now you know why we're the perfect match for OA and CAD workstations.

What JDL is doing. The JDL-750 brings the best of

Japanese printer design and manufacturing together with American marketing and custom engineering. This gives JDL, Inc. the flexibility and responsiveness necessary to deliver printers that meet your requirements, schedule and budget.

You be the judge. If your workstations need exceptional color graphics, letter quality, font versatility, reliability and value that can't be matched by any competing technology, call us for print samples and product specs.

One look and we're sure you'll call us again... for an evaluation unit.



(805) 495-3451



2801 Townsgate Rd., Suite #104, Westlake Village, CA 91361
CIRCLE NO. 25 ON INQUIRY CARD

Nationwide on-site service provided by NCR.



150,000 customers The WYSEpc.



FILE: (A) *E32*(1.0)(10/04/85)

Menu: Range Copy Move File Print Graph Data Quit

Global: Insert, Delete, Column-Width, Erase, Fillcolor, Window, Status

Store: 7.0x 7.3x 8.0x 6.6x 5.7x

Revenue vs. Profit (Loss)

In (\$ thousands)	Actual			Projected	
	1981	1982	1983	1984	1985
Revenue	\$3,211	\$4,324	\$5,424	\$6,374	\$7,328
Expenses					
Salaries	523	632	846	990	1,158
Admin	183	228	313	357	483
Materials	1,926	2,094	2,254	2,232	1,687
Other	353	471	379	648	746
Total Expenses	2,985	4,087	4,992	5,953	6,914
Profit (Loss)	\$226	\$237	\$432	\$422	\$414
Inflation:			8.0x	6.6x	

made us do it.

We established a precedent on better than 150,000 desktops with our terminals. So when our customers got ready to include PCs in their plans, they didn't think they should have to settle for less than Wyse style, performance and economy.

We agree. And now you can get the WYSEpc with IBM compatibility in hardware, software and expandability. We've thoroughly tested more than 350 software packages and accessories. It runs even the acid-tests—Lotus 1-2-3 and Flight Simulator—in beautiful Wyse style.

Our price *includes* dual floppy drives, monochrome 14" tilt/swivel monitor, height-adjustable keyboard, 256K RAM, two serial ports, one parallel port, MS-DOS with GW-BASIC—and more.

There's also an IBM PC/XT compatible model with a 10-Megabyte Winchester disk. A color graphics option is available on either model.

For more information about how much less all this costs from Wyse, call the regional office nearest you.

WYSE

Regional Sales Offices:

Northeast (201) 725-5054

Southeast (305) 862-2221

Midwest (313) 471-1565

Southwest (818) 340-2013

Northwest (408) 559-5911

IBM and IBM PC/XT are trademarks of International Business Machines Corporation. Lotus 1-2-3 is a trademark of Lotus Development Corporation. MS-DOS and GW-BASIC are trademarks of Microsoft Corporation.

CIRCLE NO. 26 ON INQUIRY CARD

We couldn't improve on you. So we improved on your terminal.

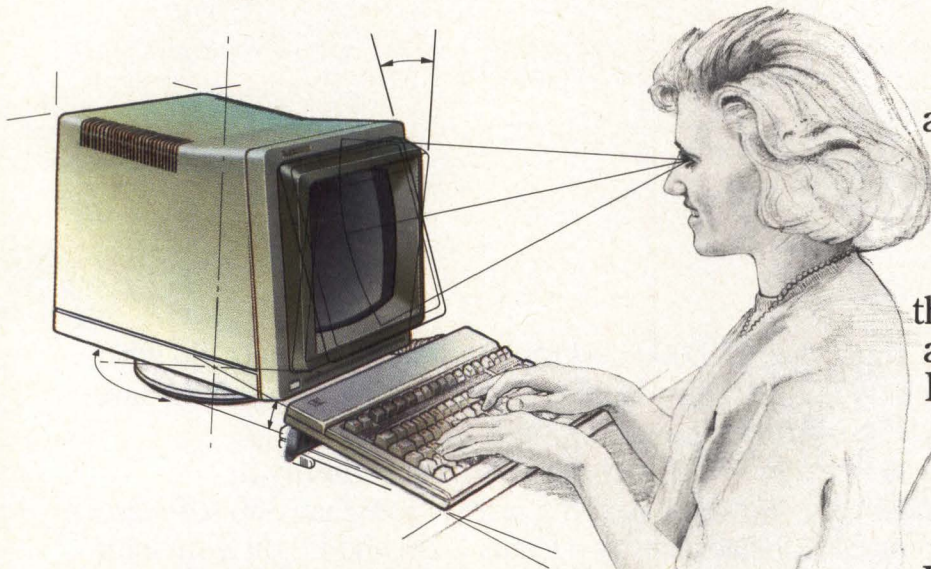

You're as good as you can be, just the way Nature made you. Unfortunately, Nature doesn't make computer terminals. So at Hewlett-Packard, we've been making improvements on terminals, to make them work more agreeably with you.

Our newest display terminal, the HP2392A, is a case in point. It has an adjustable keyboard, a screen with an integral tilt, and a monitor that can revolve.

So your people won't have to adjust, tilt, or revolve to use it.

The keyboard can be angled to lay flat on a desk, and it has contoured keys

arranged in clusters, to sit easily beneath the hands. We also made it detachable, to sit easily in the lap.

And all that is just with the unit turned off. Turn it on, and you'll see the famous HP display screen, with characters that are sharp, clear, and distinct.

What's more, the HP2392A has ANSI, so it's DEC-compatible.

All for only \$1375*.

The HP2392A. The terminal that works with people.

Find out more. Just call your local HP sales office, listed in the white pages. Or write to Terry Eastham, Hewlett-Packard, Dept. 008215, 8020 Foothills Boulevard, Roseville, CA 95678.



INTERPRETER

An analysis of news, issues and trends affecting the computer industry

BUYERS LINE UP FOR ABANDONED COMPUTERS

Demand for discontinued or overstocked computers and parts is soaring as a result of industry shakeout

Lori Valigra, Senior Editor

When IBM Corp. recently announced plans to stop production of its PCjr personal computer, rumors spread rapidly that the company would sell the remaining computer inventory to a liquidator or auction it. An IBM spokesman says neither will happen. Nonetheless, the eagerness with which prospective buyers took up the rumor is a sign of the times. Intense competition is driving even the most powerful companies from cutthroat markets, and bargain sales are now in vogue.

Orphaned products are finding their way into new "distribution channels": electronic flea markets, auctions, liquidations and sales by scrap buyers, who scavenge components and resell them. Sometimes the technology for such products is sold by one company to another. For example, Computer Devices Inc., Burlington, Mass., one of the first companies to introduce an IBM PC-compatible portable computer, didn't have the funds to manufacture it and sold the technology rights to Prime Computer Inc., Natick, Mass.

Industry is its own largest consumer

With one exception—IBM's PCjr—discontinued products continue to be purchased by individuals and companies within the computer industry. The low prices, which after abandonment can be 30 percent or more off the original list price, still have not attracted members of the general public. The public seems to prefer brand-name products from large, financially stable companies. IBM's PCjr may be the first orphan to sell well outside the closed circle



Tim Davis

Auctioneer Ross Dove is becoming the "King of the Buzzword".

of the computer industry, mainly because IBM has made clear its intentions to continue "child support."

"Discontinued products never get out to the general public. They [the public] can't handle support," explains Adolph "Sonny" Monosson, chairman of American Used Computer Co., Boston, a reseller of used equipment. Because of IBM's size, market momentum and reputation, its products are exceptions to that rule.

Osborne allayed fears

When Osborne Computer Corp. filed for Chapter 11 bankruptcy protection more than a year ago, the company was not sure whether it would liquidate or try to reorganize and repay its creditors. The uncertainty made Osborne personal computer users and any potential customers nervous. As a marketing move, the company

Potential buyers examine the goods at an auction of Convergent's Workslate division.

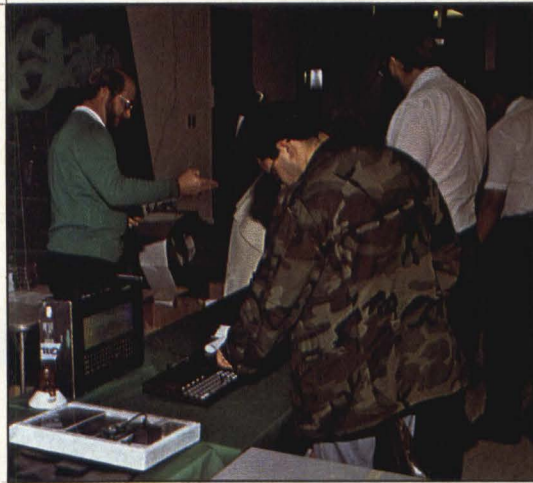

Tim Davis

signed Xerox Americare, Xerox Corp.'s large service organization, to continue the care and feeding of Osborne users.

"We felt we needed to relieve the fears of potential Osborne buyers," explains Michael Anthofer, controller at Osborne in Fremont, Calif. He says that signing on Xerox Americare helped foster consumer confidence. Now, after Osborne's reorganization, Xerox Americare and a group of others service more than 125,000 Osborne computers installed worldwide. More than 30 distributors in 80 foreign countries offer warranties and service.

When Osborne decided against liquidation, it retained an auctioneer to sell its fixed assets and some finished-goods inventory to help pay creditors. A series of 13 auctions have made Osborne a test case for high-technology auctioneering. Controller Anthofer explains that at the first two auctions, run by Ross-Dove Co., San Francisco, Osborne sold fixed assets, such as furniture and some used computers, but no finished goods or computer inventory. Those auctions brought in \$1.4 million. But at the third auction, the company sold some inventory as well as used computers at close to retail prices. "We were surprised at how well the auction went. The auction place was packed," Anthofer says.

At the beginning of the auctions, Osborne had about 2,000 units sitting on the shelf. Ross-Dove and Osborne organized a seven-city tour, which resulted in the sale of 750 units and brought in about \$450,000. The auctions, which had a rough start in Los Angeles, improved in each city. One of the more valuable lessons learned by Osborne was what price users were willing to pay for Osborne computers. What originally sold for more than \$1,000 new brought in about \$700 to \$900 at the auctions. "During the auctions, we found the price at which products would move,"

says Anthofer. This helped the company sell 500 to 600 more units on its own after the auctions.

Anthofer says Osborne received more for complete computers than it did for a comparable sum of separately sold parts. This is because the CPU is proprietary and the disk drives, which are single-sided, double-density models, are in limited demand.

Ross-Dove received about 10 percent of the \$450,000. The rest went to Osborne. Anthofer says high-technology auctions have become so popular on the West Coast that auctioneers are dropping their usual 10 percent to 12 percent charge to 5 percent to 7 percent just to handle an auction valued at \$1.5 million.

Anthofer chose auctions over other alternatives because they bring in more money. For example, he had proposals from liquidators offering about 25 percent to 50 percent of what he could make from an auction. "For a \$1,000 item, a liquidator will offer you \$250 and resell it for \$600. So why not hire an auctioneer to sell it for \$600 and offer him [the auctioneer] 10 percent of what he sells?" Anthofer expects liquidators to be hurt, should auctions increase in popularity.

He estimates that there were more than 10 auctions after Osborne's. Convergent Technologies Inc.'s Workslate division, Santa Clara, Calif., and Gavilan Computer Corp., Campbell, Calif., were among two of the largest. Both Gavilan and the Workslate division are now defunct. The Gavilan auction was valued at \$1 million. Convergent's was a multimillion-dollar event, partly because of pricey specialized equipment, such as surface-mount machines for semiconductors, required for Workslate's laptop, data-entry device.

More than 1,000 people attended the Workslate auction, at which 5,000 devices and peripherals, as well as capital equipment, were sold, says Ross Dove, a partner at Ross-Dove. Dove says the Workslates ranged in price from \$165 to \$300. One liquidator purchased about \$400,000 worth.

Auctions can carry stigma

An auction is a typical solution used during a distress situation marked by an excess of unsold or discontinued items, explains Anthofer. "If cash is the consideration...then an auction is a very viable vehicle."

But for companies wishing to sell only overstock, an auction may bring with it an unlooked-for stigma. "The problem with auctioning is that it looks like a distress move. In our case, it isn't at all," explains Carolyn B. Kilbourne, manager of direct marketing for Metric Resources Co.,

The new Canon[®] Handy Terminal makes any computer system go farther.

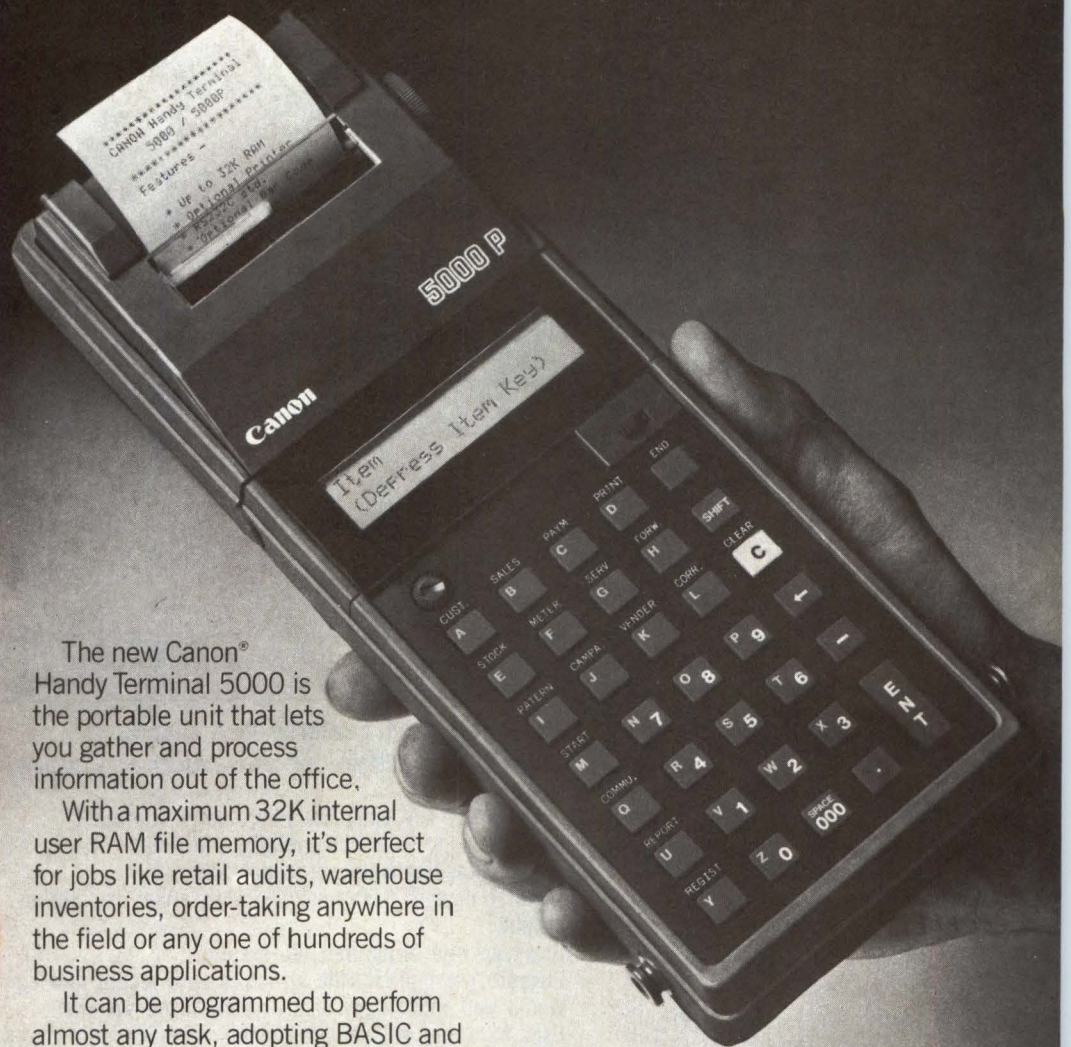

The new Canon[®] Handy Terminal 5000 is the portable unit that lets you gather and process information out of the office.

With a maximum 32K internal user RAM file memory, it's perfect for jobs like retail audits, warehouse inventories, order-taking anywhere in the field or any one of hundreds of business applications.

It can be programmed to perform almost any task, adopting BASIC and Assembler languages.

And can even relay information to your computer via phone hookup.

Portability is also the key word of the 5000, because Canon's Handy Terminal was especially designed for traveling light.

At a weight of less than 2 lbs., it can operate on a rechargeable battery and can be carried by neck strap or in an attache case. Yet it's highly durable, water resistant and shock resistant. Which means it can take its fair share of hard knocks.

© 1985 Canon U.S.A., Inc.

Also available is the 5000P (shown above) which has a built-in thermal dot printer that can print one original and a copy.

And both terminals can incorporate an optional bar code reader.

So why not widen your computer horizons with Canon's new Handy Terminal. It lets you go as far as you like.

For more information:
Call 1-800-323-1717, Ext. 302.
(In Illinois call 1-800-942-8881, Ext. 302.)
Or Write Canon U.S.A., Inc.,
Systems Division/Handy Terminal,
P.O. Box CN 11250, Trenton, N.J. 08650.

Canon Systems Division

CIRCLE NO. 28 ON INQUIRY CARD

Only Microware's OS-9 Operating System Covers the Entire 68000 Spectrum

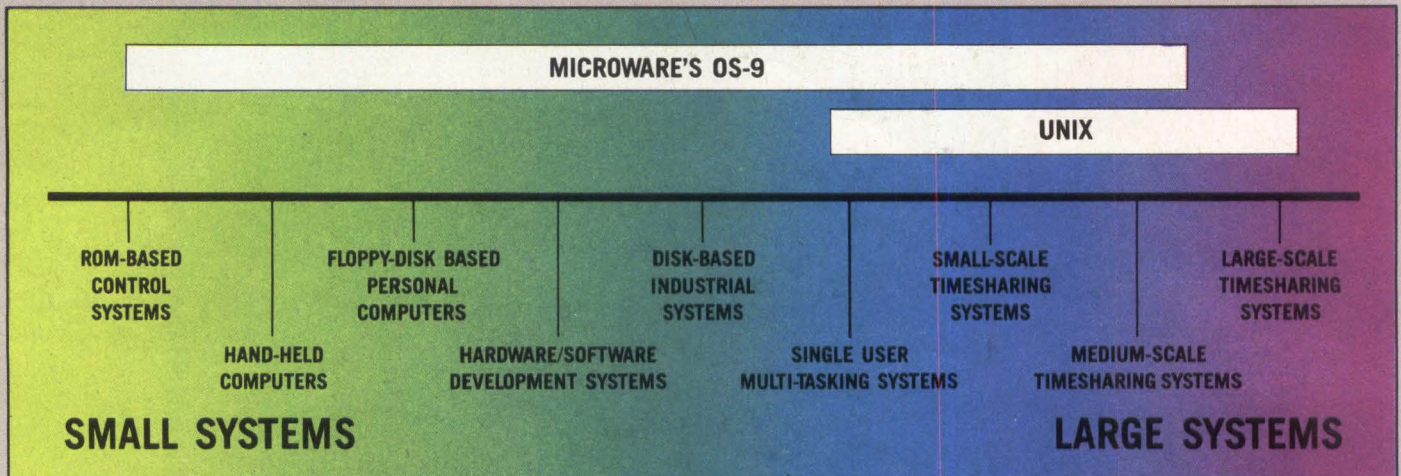

Is complicated software and expensive hardware keeping you back from Unix? Look into OS-9, the operating system from Microware that gives 68000 systems a Unix-style environment with much less overhead and complexity.

OS-9 is versatile, inexpensive, and delivers outstanding performance on any size system. The OS-9 executive is much smaller and far more efficient than Unix because it's written in fast, compact assembly language, making it ideal for critical real-time applications. OS-9 can run on a broad range of 8 to 32 bit systems based on the 68000 or 6809 family MPUs from ROM-based industrial controllers up to large multiuser systems.

OS-9'S OUTSTANDING C COMPILER IS YOUR BRIDGE TO UNIX

Microware's C compiler technology is another OS-9 advantage. The compiler produces extremely fast, compact, and ROMable code. You can easily develop and port system or application software back and forth to standard Unix systems. Cross-compiler versions for

VAX and PDP-11 make coordinated Unix/OS-9 software development a pleasure.

SUPPORT FOR MODULAR SOFTWARE — AN OS-9 EXCLUSIVE

Comprehensive support for modular software puts OS-9 a generation ahead of other operating systems. It multiplies programmer productivity and memory efficiency. Application

software can be built from individually testable software modules including standard "library" modules. The modular structure lets you customize and reconfigure OS-9 for specific hardware easily and quickly.

A SYSTEM WITH A PROVEN TRACK RECORD

Once an underground classic, OS-9 is now a solid hit. Since 1980 OS-9 has been ported to over a hundred 6809 and 68000

systems under license to some of the biggest names in the business. OS-9 has been imbedded in numerous consumer, industrial, and OEM products, and is supported by many independent software suppliers.

Key OS-9 Features At A Glance

- Compact (16K) ROMable executive written in assembly language
- User "shell" and complete utility set written in C
- C-source code level compatibility with Unix
- Full Multitasking/multiuser capabilities
- Modular design - extremely easy to adapt, modify, or expand
- Unix-type tree structured file system
- Rugged "crash-proof" file structure with record locking
- Works well with floppy disk or ROM-based systems
- Uses hardware or software memory management
- High performance C, Pascal, Basic and Cobol compilers

microware[®]
OS-9[™]

MICROWARE SYSTEMS CORPORATION
1866 NW 114th Street
Des Moines, Iowa 50322
Phone 515-224-1929
Telex 910-520-2535

Microware Japan, Ltd
41-19 Honcho 4 Chome Funabashi City
Chiba 273, Japan
Phone 0474-22-1747
Telex 298-3472

OS-9 is a trademark of Microware and Motorola. Unix is a trademark of Bell Labs.

CIRCLE NO. 29 ON INQUIRY CARD

Gaithersburg, Md. Metric Resources is a division of Leasametric Inc., Foster City, Calif., a computer and test equipment rental company. Metric Resources sells used or surplus equipment obtained from Leasametric.

Kilbourne says the need to trim inventory is typical of the computer rental market. According to Kilbourne, the company recently had more than \$150 million in inventory and planned to auction off about 1 percent.

Another company that recently rid itself of excess inventory with Ross-Dove's help is ISI International, Sunnyvale, Calif. In March, ISI auctioned test equipment for old IBM computers.

"The equipment tied up our assets. The only convenient way to free up cash was to use an auction," explains Richard Barnes, vice president of operations at ISI. Barnes says selling the equipment himself would have been too time-consuming. ISI made several million dollars on the auction, selling about 10 percent of inventory excess. Barnes agrees with Kilbourne about the

stigma of auctions but contends that the auction had nothing to do with the viability of his company.

Barnes says having an auction requires a three-pronged decision. He says the sponsoring company has to decide whether it can afford to let its inventory sit on a shelf, how much money it can expect to make and whether it wants to unload its goods in one fell swoop. "I don't recommend using an auction unless you have a lot of volume or a high value of goods or a combination thereof," he says. Because more goods draw more people willing to pay better prices, he says, it would have been better had he auctioned his test equipment in combination with another auction—for example, Gavilan's.

Newcomer quickly learns jargon

Though high-technology auctioning is new to Dove, whose company has been in business since 1937, he has adapted to computer industry products and jargon. His admirers say he has lost no time in mastering computerese. "Ross is quickly

Typical auctions are well-planned affairs

A well-conducted, high-technology auction is as programmed as any other serious enterprise in the computer world.

While moving computers and peripherals is a comparatively new venture for Ross-Dove Co., San Francisco, the auction house brings to it nearly 50 years of expertise in finding buyers and setting prices.

For starters, Ross-Dove and other auction professionals identify both clients and potential bidders well before the first item goes on the block.

One recent client, ISI International, Sunnyvale, Calif., wanted to release some money tied up in unsold computer testing equipment. ISI vice president of operations Richard Barnes recalls that 10 days to two weeks before the auction, Ross-Dove sent an announcement of the event to its own list of prospective attendees. Then, about a week later, Ross-Dove mailed the prospects a catalog describing the items to be auctioned. And, as a further inducement, potential buyers were invited to examine the goods two days before the auction.

The client is given the added assurance that serious buyers will attend; Ross-Dove requires that prospects pay a \$100 to \$150 registration fee to take part in the bidding. The fee can be applied toward a purchase but is otherwise non-returnable. The registration lists also help Ross-Dove in compiling its prospects file.

Computer auctions also resemble other such sales

in that the fever of competition between buyers sometimes drives up prices.

Brian Gamberg, president of Cory Components, a Venice, Calif., parts dealer, insists that the bidders often go to the auction hall with a firm price ceiling in mind. But Gamberg admits that the ceiling often gives way under rising pressure. Often, too, he says, a bidder will go above a self-imposed limit simply to justify time and effort already expended.

Referring to a Gavilan Computer Corp. auction he attended, Gamberg says, "We were amazed at the people who went there to make money on a retail basis. They wanted to buy an [IBM Corp.] PC for \$2,000 and resell it for \$3,000. But they were sorely displeased" and wound up buying machines for \$3,900 that they could have purchased new for \$3,800.

Gamberg says the high prices kept him from buying any machines. Still, he maintains, just about everything at an auction will find a buyer.

At that same auction, he says, he bought 60 crates of thermal paper, in its original packaging. He paid \$6,000 for \$62,000 worth of paper, hoping to resell it for about \$31,000 to sellers of thermal printers and typewriters. Gamberg found, however, that every such company he went to had all the paper it needed. Now, he says, he is looking to sell his "wind-fall" for scrap at \$11 to \$22 a ream. "It's an embarrassment," he concedes.

American Used Computer's "Sonny" Monosson says discontinued products, perhaps with the exception of IBM's PCjr, seldom get out to the general public.

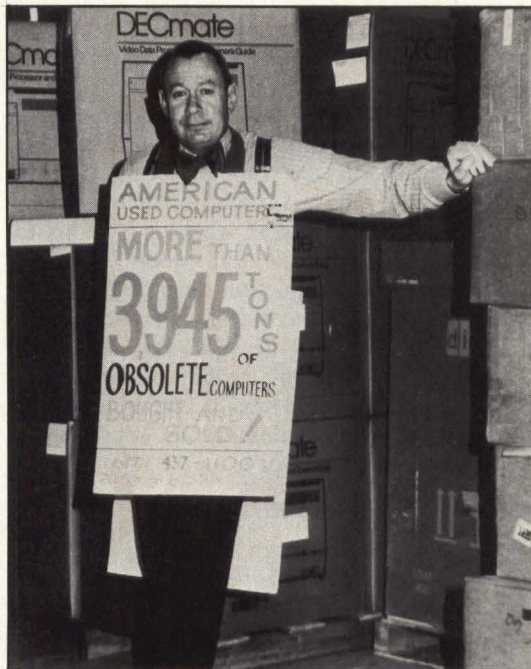

becoming the 'King of the Buzzword,' says one company official who retained Dove's services.

ISI's Barnes says auctions still are mostly a West Coast phenomenon because of the entrepreneurial spirit there. "There is a higher start-up and turnover rate [than on the East Coast]. Companies go belly-up, and, therefore, there's a need for Ross-Dove's type of service," he explains.

Auctions can be frenzied

The frenzy of buyers looking for good deals at an auction sometimes makes for almost indefensible buying decisions.

Barnes explains that some items go for nearly retail value. "I had some IBM Personal Computer inventory. For some strange reason, people are willing to pay almost store value for PCs at an auction. It can't be anything but the [brand] name." He says first-time buyers are the ones usually caught up in what he calls "auction mania."

Brian Gamberg, president of Cory Components Inc., Venice, Calif., who buys and resells computer parts, notices the same phenomenon. He went to the Gavilan auction with orders in hand for about 25 IBM PC/XTs. Gavilan was a high-volume user of IBM microcomputers, he explains. But soon after the bidding began, he says, the units reached a price which would have been imprudent to pay.

Part of the reason for the general increase in prices is that more people are attending auc-

tions. The more attendees, the greater the demand and the higher the price. Gamberg explains that he used to pool resources with other companies to buy equipment, which kept prices to each company lower. But, he explains, while an auction valued at \$5 million would have drawn 50 buyers last September, the equivalent auction would have drawn 250 buyers by last November, driving prices up. "This is great for the people who own the material [being auctioned], but it's bad for guys like me," says Gamberg.

Slim pickin's for scavengers

Though most manufacturing companies sell off "scrap" parts regularly, newer models of computers have not yet become candidates for the junk heap or targets for scavengers. Osborne's Anthofer says he does not know of anyone's buying computers and stripping them down to remove memory chips and other parts.

If Gamberg does purchase a completed assembly, he resells it to a maintenance, repair and overhaul organization. Some of these organizations are being started by former employees of defunct companies who continue to service the company's products. Gamberg says he knows of two such people servicing Gavilan computers.

Nevertheless, many old computers are sold for scrap. Twice a year, American Used Computer's Monosson calls in Taiwanese scrap dealers who work out of New York. He says he sells a 30,000-pound truckload of computers for 15 cents to 35 cents a pound, depending on the value of the components in the computers. The parts are reused in Taiwan. He says there is no customs duty on the scrap, which has included Digital Equipment Corp. PDP-6, PDP-9 and PDP-12 computers and older IBM 360 mainframes.

Another profitable way of moving old equipment is to run a one-week sale. Monosson's company is near several major universities, so he held a one-week sale on equipment such as DEC 11/150s and microcomputers. The systems sold for \$50 or \$100 each, he says.

Monosson maintains that there still is a healthy demand for used equipment, "and 1985 will be one of the best years ever for the used market." He says American Used Computer sells used equipment in technical markets, in which users don't require much support and will repair their own equipment. □

Interest Quotient (Circle One)
High 450 Medium 451 Low 452

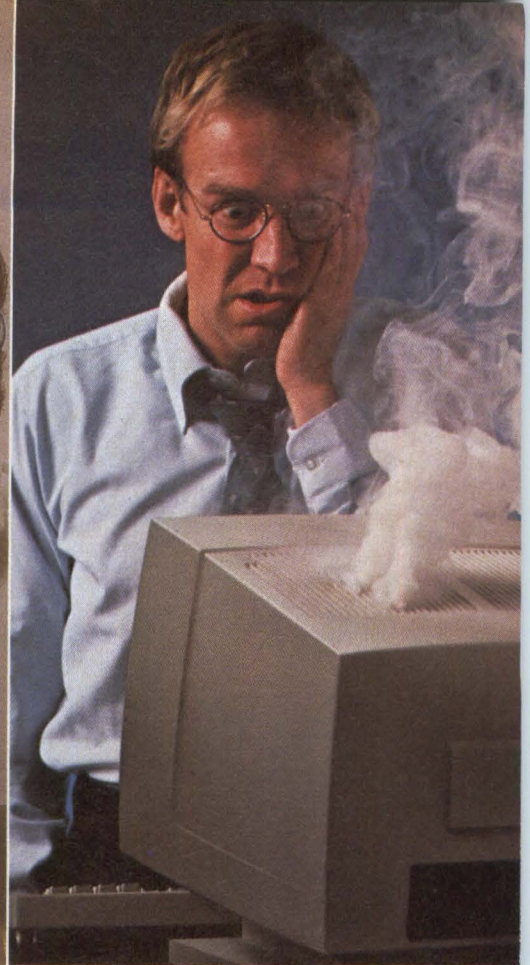
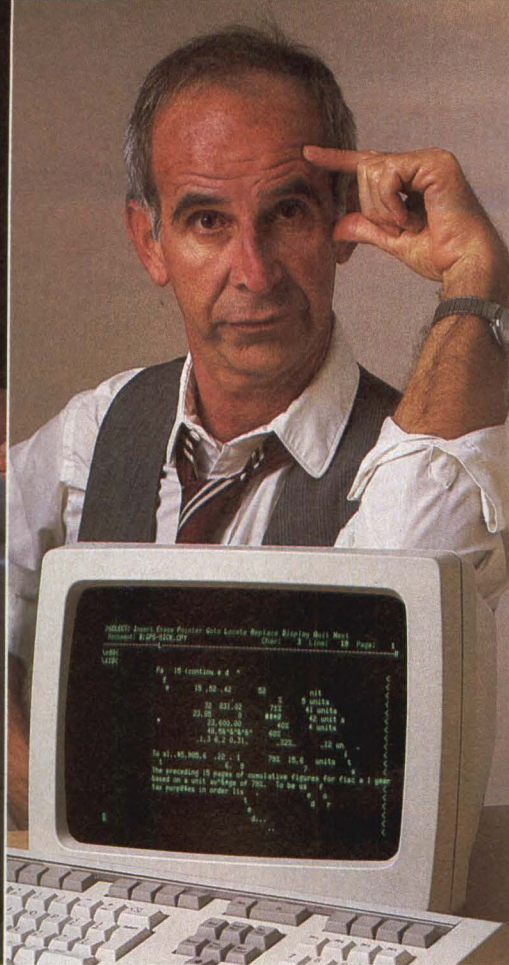

A. Once you're in the dark? **B.** During a total memory loss? **C.** After the smoke clears?

When is the right time to buy a UPS?

D. None of the above.

Don't wait for a power outage to blackout your vital system data—or high frequency noise to scramble your memory—or high line voltage or a sudden spike to blow your fuses or melt your wires!

The time to buy an uninterruptible power supply is now, before power problems cause inefficient, even catastrophic damage to your microprocessor-based installation. And the high-quality source for UPSs is General Power Systems, manufacturer of the industry's most complete line of uninterruptible power supplies.

GPS has the exact UPS you need to protect your data, your system and your production. On-line units range from 500VA to 50KVA and standby models from 100VA to 2KVA. Many features like battery backup, usually sold as extras, are standard on GPS models. Plus a wide range of options allows you to specify a virtually custom unit at an off-the-shelf price. In addition, GPS will tailor designs for OEM applications.

State-of-the-art operating characteristics of GPS systems give you the most for your money.



All-transistor technology, pioneered by GPS, means optimum reliability, control and ease of operation. Our on-line models are noted for their unusually fast transient response and excellent efficiency while standby units have set the industry standard with fast 2 millisecond transition time.

Equally important, UPSs from General Power Systems are manufactured to unmatched quality standards. In fact, all our UPSs for commercial users are designed, produced, tested and inspected to the same stringent standards as our parent company's line of defense products.

Your intelligent system is only as reliable as the power you put into it. Don't wait for a catastrophe. This is the time to call or write for full information. General Power Systems, 1400 N. Baxter St., Anaheim, CA 92806-1201, (714) 956-9321, (800)854-3469, in California (800) 824-8912, TELEX 182283.

GENERAL POWER SYSTEMS

A Division of ALS Corporation

See us at Booth #'s D2159 & D2160



CIRCLE NO. 30 ON INQUIRY CARD

UPIN IS A TRADEMARK OF AT&T BELL LABORATORIES. SERIES 32000 IS A TRADEMARK OF NATIONAL SEMICONDUCTOR CORPORATION.

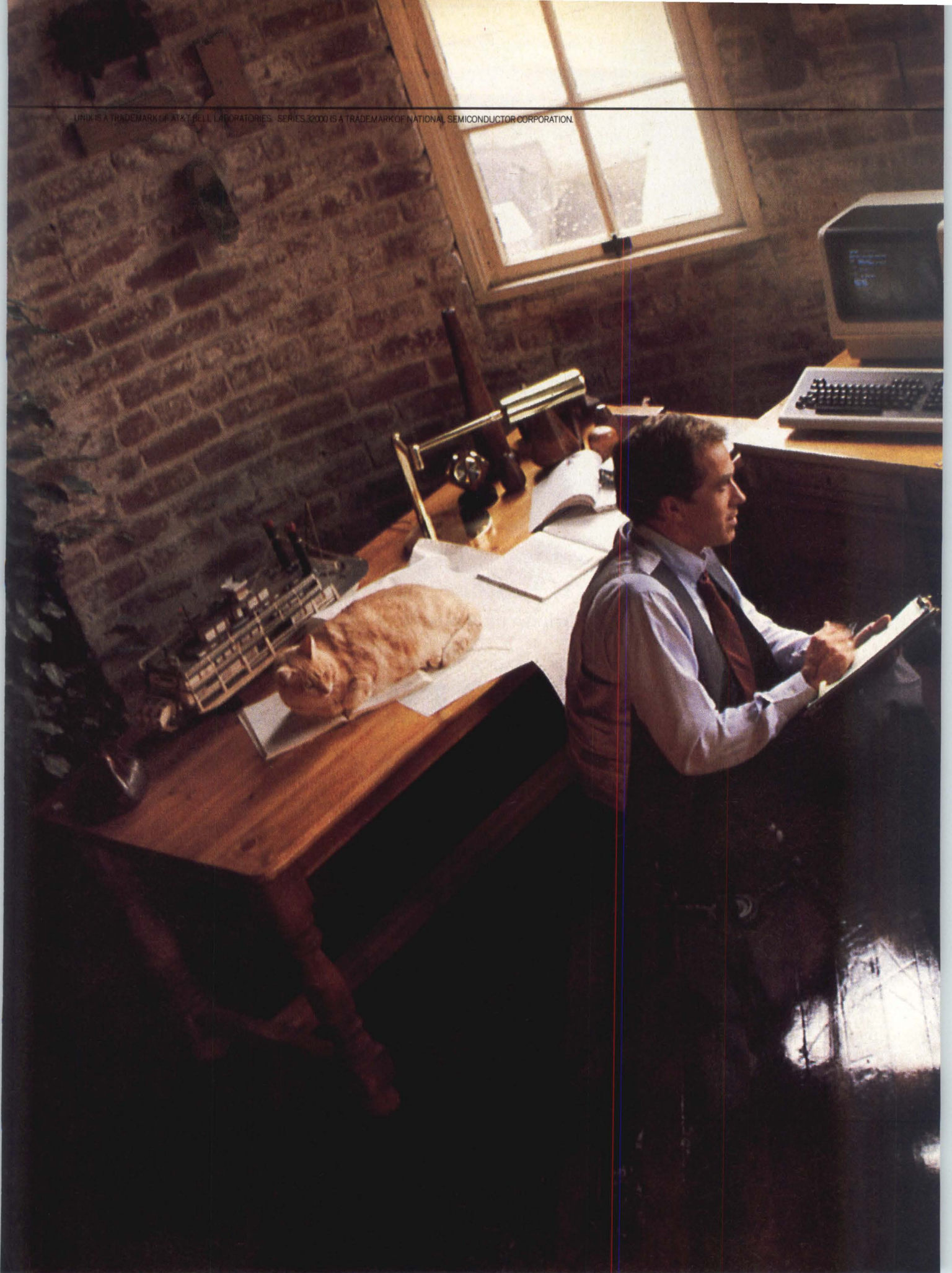

"What'll it take to build the best computer system in history?"

"Full, virtual UNIX and super-minicomputer performance for starters."

"The question is, can we do it on a micro? And on schedule?"

"As long as I don't have to code my way around an incomplete chip set."

"We've been thinking about National's Series 32000 family."

"It'll be Art."

Finally there's a 32-bit microprocessor that gives you any UNIX version you want, and all the development tools you need.

To develop an advanced micro-computer software system, you need minicomputer architecture, development tools, and high level language support. Of all the 32-bit microprocessors available today, only Series 32000™ gives you this ideal development environment. Series 32000 supports all major implementations of UNIX™, including an AT&T validated System V with virtual memory, so you can choose the version you prefer.

It's also the only 32-bit family complete with memory management, floating point, timing, interrupt and DMA control units, so you don't waste time writing

routines to make up for hardware deficiencies. So if there's a new microprocessor based system in your plans, only Series 32000 can get both software and hardware off the drawing board today.

For all the facts, write to:
Series 32000, MS 23-200
National Semiconductor
2900 Semiconductor Drive
P.O. Box 58090
Santa Clara, CA 95052-8090



National Semiconductor
We're doing it.

CIRCLE NO. 31 ON INQUIRY CARD

**SERIES
32000**

THE SUPERMINI ON A CHIP

Alloy takes your PC to the limit.

QICSTOR-PLUS. The ultimate in PC expansion with five IBM compatible slots, hard disk storage, and streaming tape backup in one neat package.

Alloy's QICSTOR-PLUS meets all your expansion needs. It's the ideal upgrade for a growing PC or AT system.

QICSTOR-PLUS has five full size expansion slots which are completely compatible with the IBM PC bus and they also support Alloy's PC-SLAVE/16 multi-processor, multi-user capability. Its high performance hard disk has a capac-

ity of 36 to 128 MBytes. And QICSTOR-PLUS has file-oriented streaming tape backup with a formatted capacity of over 50 MBytes. Alloy provides file-oriented QTIP software with a transfer rate of 2 MBytes/minute.

QICSTOR-PLUS is available right now. So call Alloy today at (617) 875-6100.

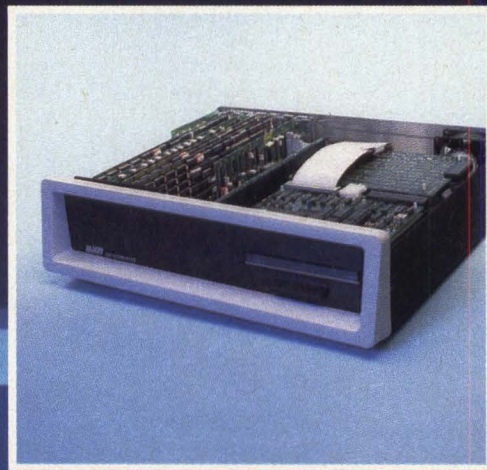

ALLOY QICSTOR-PLUS

ALLOY
Computer Products, Inc.

Alloy Computer Products Inc., 100 Pennsylvania Avenue, Framingham, Massachusetts 01701. Tel: (617) 875-6100, TWX: 710-346-0394
In Europe: Alloy Computer Products (Europe), Ltd., Cirencester, Gloucestershire, England. Tel: 0285-68709, Tlx: 43340

CIRCLE NO. 32 ON INQUIRY CARD

INTERPRETER

MULTIPROCESSOR TECHNOLOGY MEANS MORE MUSCLE, LESS FAT

When structured in a multiple configuration, high-performance, low-cost, off-the-shelf microprocessors help streamline computer architecture

Lynn Haber, Associate Editor

Tandem Computers Inc. calls it non-fat architecture—a multiprocessor system that allows users to add computing power incrementally.

The Cupertino, Calif., manufacturer of 32-bit fault-tolerant systems contends that, with conventional computer architectures, users often have no choice but to buy more system power than needed and “grow into it,” causing waste and inefficiency at the outset.

Most computing employs the von Neumann architecture, a design based on a single processing unit that allows only one task to execute at a time. Computing speed, therefore, depends on the performance of the processor chip.

On the other hand, multiprocessing architectures, which string together many microprocessors, can process various, unrelated tasks simultaneously. What is driving this market, according to Omri Serlin, president of Itom International Co., a research and consulting company in Los Altos, Calif., is the availability of new, powerful, low-cost, 32-bit microprocessors.

New possibilities abound

In addition to the availability of 32-bit microprocessors, increased floating-point performance and expanded addressing ranges have also contributed to the development of multi-computing, according to John Payne, director of strategic product development at National Semiconductor Corp., Santa Clara, Calif. “Multicomputers bridge the gap between 16-bit personal computers and superminicomputers based upon emitter-coupled-logic circuitry,” he explains.

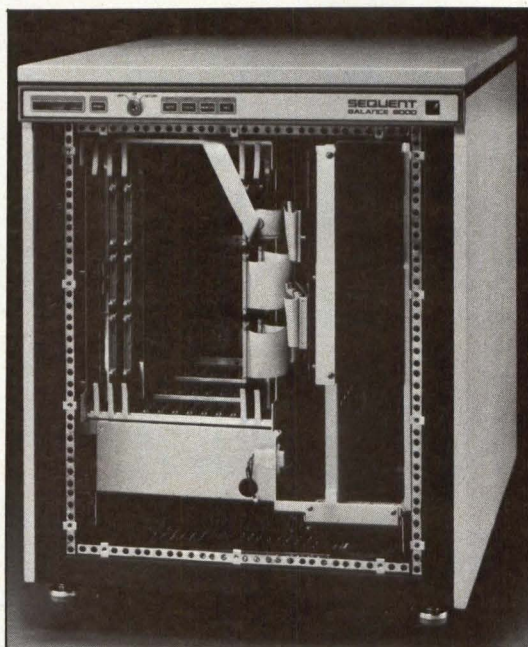

Sequent's Balance 8000 multi-processor is a minimally configured system. Shown here is a single CPU board, memory boards, a small computer systems interface, an Ethernet-control board, Multi-bus adapter.

With the advent of standard 32-bit microprocessors, system integrators can now couple processors in a tightly or loosely fashioned arrangement.

Generally, in a loosely coupled microprocessor architecture, each processor possesses its own memory and communicates with other processors via messages. In contrast, a tightly coupled architecture contains multiple processors that have access to a common memory system.

One advantage of a tightly coupled system, according to Serlin, is load balancing—a system function that allows an incoming task to be

distributed to the next available processor. Unlike loosely coupled systems, which behave much like a supermarket checkout system where

shoppers wait in several lines until a clerk is available, tightly coupled systems behave more like a bank arrangement. In this setting, custom-

The multiprocessing spectrum

Gary Fielland, Sequent Computer System Inc.

Multiprocessing offers the promise of providing performance enhancements over single-processor architecture but is a difficult technology to master. The reason? A full spectrum of multiprocessor structures exists, ranging from loosely coupled to tightly coupled. The most loosely coupled structures center on computer networks, the connection of many computers, often at a long distance from one another. At the other end of the spectrum are tightly coupled systems—specialized function multiprocessors or multicomputing.

HOW TWO DIFFERENT IMPLEMENTATIONS OF MULTIPROCESSOR ARCHITECTURE WORK

(a) LOOSELY-COUPLED COORDINATED JOB SCHEDULING

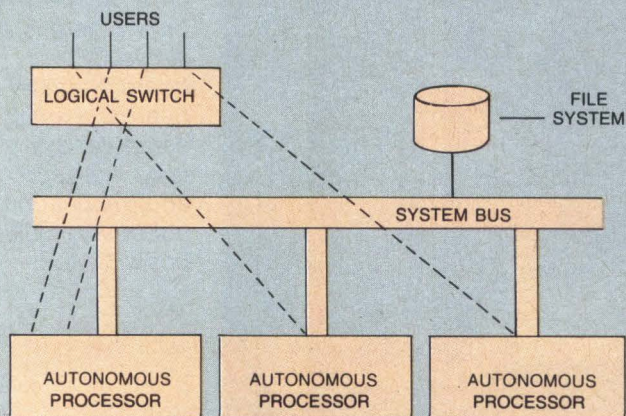

(b) TIGHTLY-COUPLED MASTER/SLAVE

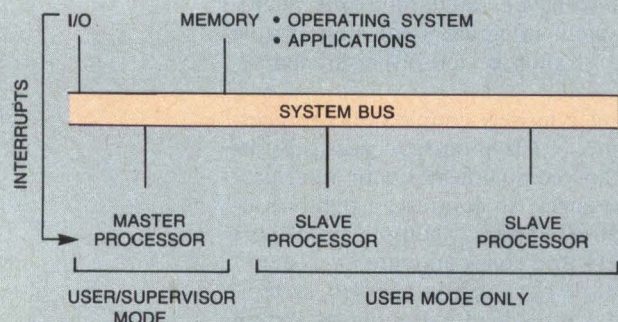

Multicomputing has been available for several years. In this approach, the application architect statically partitions the application and loads, often into ROM, the program partitions onto each board, which is a complete single-board computer, often with special-purpose hardware.

The classic multiprocessor case involves a system made up of two or more general-purpose processors, each of equal capability. In this setup, three scheduling structures are identifiable—coordinated-job, master/slave and homogeneous.

In the coordinated-job-scheduling approach (a), also called loosely coupled multiprocessing, each processor is relatively autonomous and has private access to its own interrupt system, primary storage, and, frequently, secondary storage. Each processor also has its own copy of the operating system code and data. Jobs enter the multiprocessing system and are assigned to a processor subsystem by a centralized, scheduling-policy manager, based on a variety of criteria including relative loads on the component processor subsystems. Once assigned, the job maintains its association with its processor subsystem until terminated.

In the master/slave approach (b), also called tightly coupled multiprocessing, all memory is accessible to all processors. In this technique, one processor is distinguished, usually by software, as the master, while all the others are slaves. Slaves are limited to executing "user-mode" processes. The master executes all "supervisor-mode" codes, usually in addition to executing user-mode codes. Master/slave systems are relatively simple to implement and have the potential to support parallel programmed applications.

In a general multiprocessor system, all resources, including memory, I/O devices and interrupt systems, are equally accessible to all processors. Memory and I/O devices are dynamically assigned to processes, not permanently hard-wired to processors. In this form of tightly coupled multiprocessing, processes are assigned to processors as determined by the process scheduler, with a pool of one or more processors available for scheduling. Thus, it is called a processor pool architecture.

Gary Fielland is director of advanced development at Sequent Computer Systems Inc., Portland, Ore.

ers wait in a single line for the next available teller. From a more mechanical point of view, the single-line approach allows no processor to be idle as long as the queue is full, nor does any one processor have a backup of tasks.

From both manufacturers' and users' points of view, economy is the primary benefit of multiprocessing systems. What's more, these systems can be reconfigured to satisfy a wide range of performance requirements. Initially, a start-up system usually incorporates a few processors. As the work load increases, it's a simple matter to plug in additional processors.

In more traditional computing arrangements, users must replace a system when the processing power no longer meets the extended application requirements. Or, as in Tandem's view, users must initially purchase a bigger and more expensive machine than needed.

From a system integrator's point of view, multiprocessor computers mandate only a small subset of components from which a host of systems are configured. This fact, according to Serlin, leads to savings in manufacturing, training and spare parts.

Stumbling blocks lie in wait

Compatibility is one of the key problems to overcome in order for these products to gain general market acceptance, says Serlin. "I contend that the major marketing problem facing these manufacturers is not price/performance or features, but how to sell what is essentially a non-compatible product into an environment that demands compatibility," he claims.

For established computer manufacturers such as IBM Corp. and Digital Equipment Corp., which already have huge investments in architectures and software, moving away from such investments means alienating their customer base and losing much of their investment.

Serlin maintains that, rather than risk what they have established, large computer manufacturers will work within the existing hardware and software frameworks and eventually offer customers loosely coupled systems.

For such multiprocessor system manufacturers as Sequent Computer Systems Inc., Portland, Ore., and Encore Computer Corp., Wellesley Hills, Mass., as well as for a handful of companies that design products based on a multiprocessing architecture, implementing external compatibility with the UNIX operating system—a de facto industry standard—appears to be a way of getting around the issue of compatibility.

"No doubt these companies are hoping that UNIX will be adopted as a worldwide standard,"

says Serlin. "In the meantime, they can ameliorate objections to using non-standard architectures."

In markets such as banking, brokerage and manufacturing, where there are substantial investments in IBM equipment, manufacturers of multiprocessing systems must offer compatibility to IBM's Systems Network Architecture. Offering software that makes multicomputers appear, within the IBM system, as an IBM host proves a necessary tactic for companies hoping to attract these strong markets.

Another approach taken by some multiprocessor manufacturers, involves offering database query languages similar to those used by IBM, as an additional way to satisfy users' requirements.

In September 1984, Sequent introduced a Berkeley UNIX Version 4.2-based, 32-bit computer family for technical OEMs. According to Ron Parsons, technical marketing manager at Sequent, the company's Balance 8000 computer

As opposed to von Neumann architecture

(top), a design based on a single processing unit that allows only one task to take place at a time, Encore's Multimax is based on a tightly coupled multiprocessor architecture (bottom) that incorporates a pool of 32-bit processors.

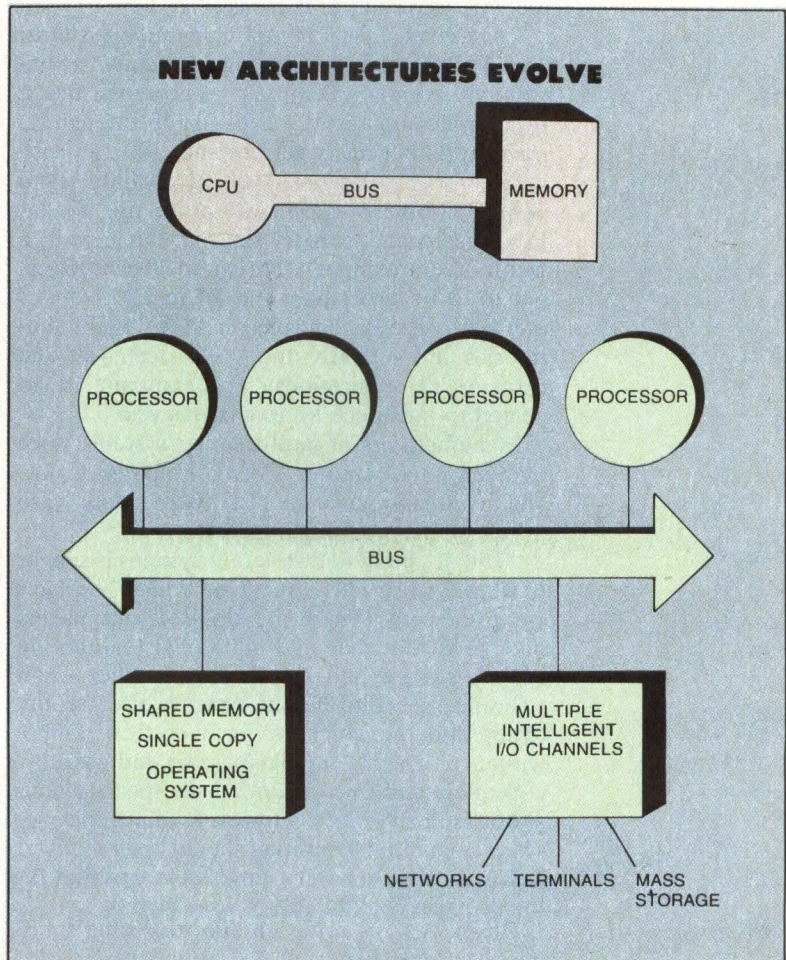

system is based on a pool of two to 12 National Semiconductor series 32000 processors.

Sequent also offers a PC-Interface, manufactured by Locus Computing Corp., a PC-DOS-to-UNIX software-application bridge that reportedly provides transparent interaction between PC-DOS applications and Balance 8000's UNIX file system over a distributed network.

Convenience for OEMs

Parsons believes that the most apparent benefits of these systems are a good price/performance ratio and expandability. This type of architecture is very convenient for OEMs trying to plan a yearlong development cycle. "Often, while system integrators are developing software, they discover that more CPU power is required. Multiprocessing architecture is a simple solution to that sort of problem," Parsons says.

For typical multistream, computer-intensive applications, system performance should range from 5 million to 7 million instructions per second, according to Parsons.

Encore subsidiary Hydra Computer Systems, Natick, Mass., is developing Multimax, a machine the company claims is "as economical as a superminicomputer yet expandable enough to match a mainframe's performance."

According to Encore, Multimax is based on a pool of 32-bit processors, with processing power, I/O capacity and memory size that can grow by a factor of approximately 10 (two to 20 processors, one to 10 I/O computers and 4M to 32M bytes of memory). The system runs on AT&T Bell Laboratories Inc.'s UNIX and serves technical and commercial applications. The company is expected to introduce Multimax this year.

Manufacturers of fault-tolerant systems, such as Synapse Computer Corp., Milpitas, Calif., and Sequoia Systems Inc., Marlboro, Mass., also utilize multiprocessing architectures.

"The design of fault-tolerant systems is similar to what Encore and Sequent are doing," explains Itom's Serlin. "Where the fault-tolerant makers diverge is that they add additional features, in both hardware and software, to support fault tolerance." Fault-tolerant systems offer redundancy and the ability to recover from failure without impacting the database or end user.

Sequent and Encore don't make special claims about fault tolerance. However, multiprocessor systems continue operating should one processor fail, with the remaining processors carrying the entire work load.

Businesses requiring on-line, real-time transaction processing, such as airline reservation

systems and banking, favor multiprocessing architecture. Additionally, the scientific and technical communities rely on powerful processing ability and fast processing speed.

Serlin believes that multiprocessing is currently more of a technology than a market but that the prospects for these products are good. "The inherent advantages of this type of architecture are so great that the market cannot ignore them," he asserts.

On-line transaction processing, a market that generated some \$22.5 billion in 1984, according to industry analysts, is the largest identifiable market using multiprocessing-based systems.

With the exception of Tandem and Stratus Computer Inc., Marlboro, Mass., fault-tolerant manufacturers have suffered tough financial times. "I think this will be a difficult market to penetrate in the foreseeable future," says Serlin, "but I've little doubt that, over the long term, users and investors will realize the advantages of this architecture."

Although multiprocessor architectures can run tasks in parallel—more than one task at a time—true parallelism, or breaking down a single problem into many tasks, requires special software and support.

According to National Semiconductor's Payne, not much language support exists for parallel processing, but a lot of research is under way. "We're at a watershed point. Over the next five years, we'll see this happen."

Sequent's Parsons believes that it will take one to two years for the market for these products to heat up. During this time, manufacturers must educate users via literature, seminars, articles and training.

Payne also believes that there's practically no limit to the performance these machines can offer. He sees the technology moving toward integrating more functions and reducing the amount of board space needed to implement a given system. "System integrators will pack more and more into the same box," he says. "The biggest concern will be the availability of software to support parallel processing."

The superminicomputer and mainframe markets, however, are not expected to disappear as a result of multicomputing. "There will still be a need for high-performance, raw computing power," says Payne. "But, the growth in this industry will come primarily from multicomputers." □

Interest Quotient (Circle One)
High 453 Medium 454 Low 455

The low-cost DEC memory alternative

digitalTM

1. VAX Memory
2. Q-Bus Memory
3. UNIBUS Memory
4. 15+ Years' Experience
5. Quality
6. Reliability

DATARAM

1. VAX Memory
2. Q-Bus Memory
3. UNIBUS Memory
4. 15+ Years' Experience
5. Quality
6. Reliability
7. Extended Warranty
8. Immediate Delivery
9. Low Price

Dataram Corporation
Princeton Road, Cranbury, NJ 08512
FOR IMMEDIATE ACTION:
(609) 799-0071

The Digital logo, Q-Bus, UNIBUS and VAX are trademarks of Digital Equipment Corporation.

CIRCLE NO. 33 ON INQUIRY CARD

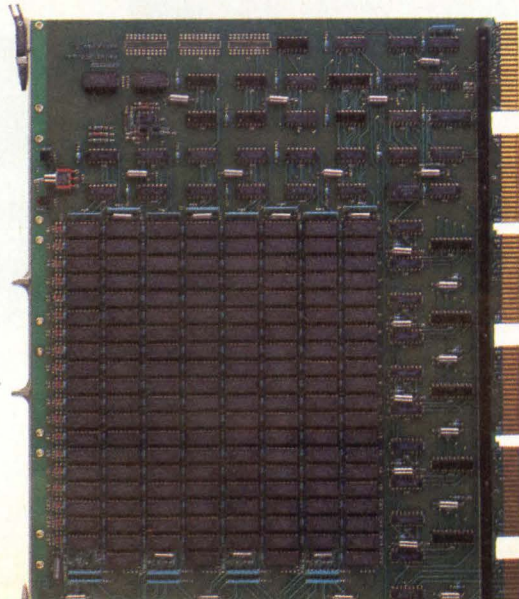

Archive puts with backup.



This is a success story. Starring the industry's #1 half-height 5¼" streaming tape drive. And you.

The right time for backup.

The systems you're designing today need backup more than ever.

That's because they're being used in more important applications than ever. For accounting and word processing. As engineering workstations. And multi-user, multi-station systems. With more complex software. Growing data bases. Winchesterst that have 10MB to over 100MB capac-

you out front

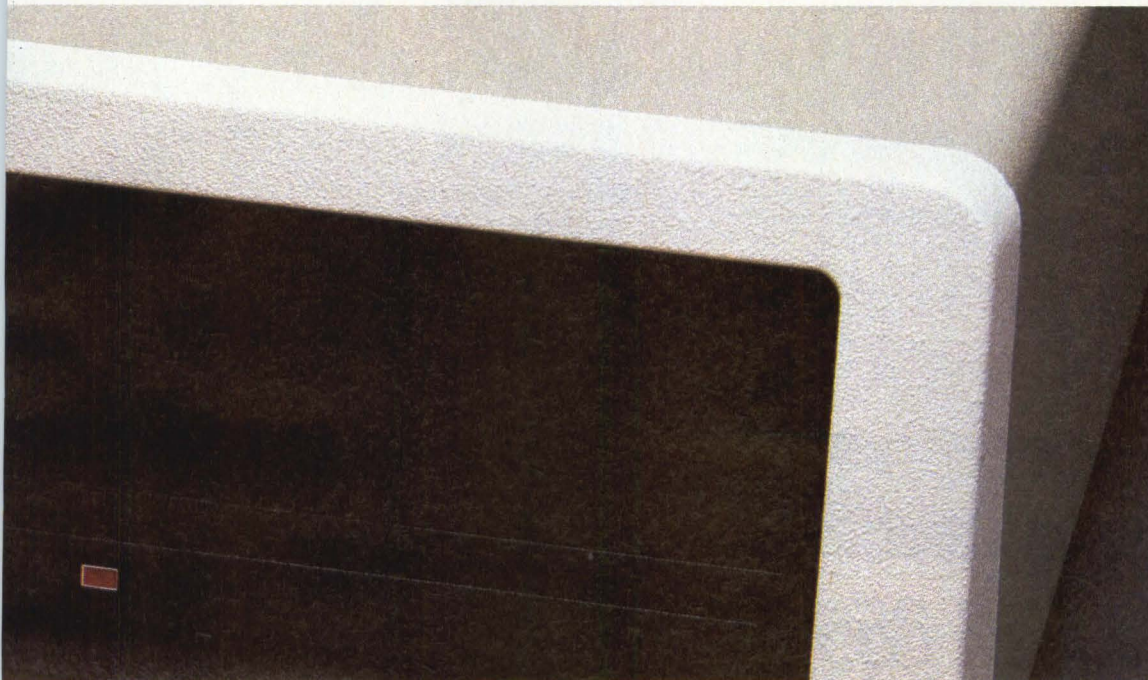

ity. And customers who demand dependability and the simplicity of tape backup.

The right time for Archive.

The time's right for Archive. We've got the right product for you. At the right price. With the right support.

Put our half-height 1/4" streamer into your system and you've got 20 to 60MB of fast (four to nine minutes), convenient backup with a single cartridge.

We build the most dependable 5 1/4" drive in the

industry. With a more reliable motor — brushless DC. A better loading mechanism — fewer moving parts. Proprietary LSI. And the dependability that comes from devoting over three years to building 1/4" streaming tape drives and nothing but 1/4" streaming tape drives.

We've got you covered.

We've got the right approach to system integration, too. We build a half-height drive with the industry-standard QIC-36 Basic Interface. Use our SCSI, IBM PC or QIC-02

controllers/formatter boards for simple, quick system integration.

No matter how successful you are we've got the manufacturing capacity to meet your volume needs, including a new off-shore plant to support you worldwide. Nobody's shipped more half-height 5 1/4" tape drives than Archive. No one ever will.

Write your own success story.

We'll put you out front in tape backup. With the support you need to ensure system success. Just dial (714) 641-0279. And backup is on the way. Archive Corporation, 3540 Cadillac Avenue, Costa Mesa, CA 92626. Telex: 4722063.



We've got the half-height 5 1/4" tape drive your system needs, and the QIC-02, SCSI and PC-compatible controllers you need to speed and simplify system integration.

ARCHIVE

Out front with backup.

CIRCLE NO. 34 ON INQUIRY CARD

Both letter-quality and draft hard copy

Fastest document throughput in its class

Both friction and tractor paper feed

Industry standard serial and parallel interfaces.

Better, more versatile operator controls

TI reliability

Compatibility with third-party and proprietary software

Better, more durable easy-access font modules

The TI 855 microprinter. No other printer says better so many ways.

Feature for feature, no other microprinter can match the versatility, compatibility, reliability and productivity of the OMNI 800* Model 855 microprinter. Here's why.

Two Printers In One. With the TI 855 you get the speed of dot matrix draft copy. Plus the precise clarity of the most advanced matrix technology for letter-quality print. It's two printers in one — at one low price.

A Great Family Name. Texas Instruments is known for providing the world with the industry standard for printers — the TI 810. TI builds the same reliability into every 800 series microprinter. Both the 855 and the data processing Model 850 are part of the expanding TI line of high-performance, low-cost microprinters.

Hardware Compatible. The TI 855 microprinter is compatible with all major PC hardware. And it provides both serial RS232C subset and "Centronics-type" parallel as standard interfaces.

Software Compatible. The TI 855 uses industry standard escape sequences for compatibility with virtually all third-party software. And for those with proprietary software needs, a model is available with ANSI standard escape sequences.

Tough Font Modules For Quick Character Change. Three font modules can be inserted into the front of the printer at one time, and are accessed individually. Each contains both draft- and letter-quality character sets. They're easier to use, more reliable and more durable than traditional metal or plastic daisy wheels.

More Productivity Than Any Other Microprinter. The 855 offers both friction and tractor paper feed, to handle all types of word and data processing applications. A quick-change snap-in cartridge ribbon. Raster and mosaic graphics. And intelligent printing which maximizes document throughput — regardless of format.

Get the printer that makes for better information systems. For more information visit your nearest TI authorized dealer or write Texas Instruments Incorporated, P.O. Box 809063, Dept. DPF-00000, Dallas, TX 75380-9063. Or call toll-free: 1-800-527-3500.



TEXAS INSTRUMENTS

Creating useful products and services for you.

VERTICAL MARKET INTEGRATOR

*Applying integrated systems
in industry, engineering and commerce*

LAW OFFICE IMPLEMENTS MULTIUSER MICRO, DBMS

Multiuser microcomputer and advanced DBMS provide multifile client management and accounting capabilities to law offices

Gene Kadish

Legal Technologies Inc.

Since most law firms planning to computerize also plan to expand and already require a large amount of mass storage, they should consider multiuser systems. A standalone personal computer would be overburdened from the start.

Last year, one law firm's search for a suitable multiuser system led to a customized solution in which several hardware and software components were integrated to cover all aspects of office management and operation. Because mini-computer power is not necessary for most small and medium-sized law firms and because there are only a few options for small multiuser micro-computer configurations, the law firm easily narrowed its choices.

The firm wanted cost-effective, easy-to-use software that addressed a lawyer's unique needs. As for hardware, the selected equipment had to be fast, expandable, flexible and powerful enough for the application. And, because the lawyers were concerned about short-term obsolescence, they wanted a system that would remain up-to-date for several years. In addition, they wanted proven and debugged, multiuser, multitasking capability.

To help them in their search, the lawyers hired consulting company Legal Technologies Inc., Trevoise, Pa., which evaluated several hardware systems. The consulting company, which eventually became an OEM for Convergent Technologies Inc., Santa Clara, Calif., configured a system called the Paper Chaser. It comprises hardware and word-processing software from Con-



Legal Technologies' Paper Chaser system

for law firms combines Convergent Technologies' hardware and System Automation's reQuest DBMS to provide master case and client management, docket control, calendaring and "tickler" files.

vergent, the reQuest database-management system from System Automation Software Inc., Silver Spring, Md., an appointment calendar from DYDX Inc., Tempe, Ariz., and accounting software from Applied System Technologies, North Wales, Pa.

Based on Intel Corp.'s 80186 and Motorola Inc.'s 68010 microprocessors, the Convergent microcomputers provide true multiuser, multitasking architecture and distributed intelligence. In addition, new Convergent products are compatible with older ones, and older hardware can be upgraded.

After analyzing virtually every law-firm-management software package then available, Legal Technologies found that most packages had been developed for a specific law firm, then repackaged and marketed for general use. Others had been watered down to fit a common denomina-

Under a custom menu 'umbrella,' reQuest displays all the options available for an application.

tor and thus were not strictly applicable to the lawyers' needs. To use them, the firm would have had to change its procedures to fit the package.

Despite these drawbacks, the firm could not afford to hire programmers to write appropriate programs from scratch. To serve the application's needs and to stay within the firm's budget, Legal Technologies determined that a strong, flexible and user-friendly DBMS program was necessary. After analyzing the database programs on the market, the company chose System Automation's reQuest. A relational DBMS, reQuest provides multiuser, multfile capabilities, and it extends computer, file, program and field security beyond that normally available under Convergent Technologies' operating system (CTOS).

Because each legal office has unique needs depending upon field of law, type of billing and operating procedures and each of these variables requires its own fields of information, Legal Technologies has configured solutions based on reQuest for most legal specialties. These include





master case and client management, docket control, calendaring and "tickler" files. For legal accounting, available applications include time-keeping and billing for hourly, straight and contingent fees; reimbursable expenses; receipts/accounts receivable; disbursements/accounts payable; and general ledger.

Under a custom menu "umbrella," reQuest displays all the options available for an application. All reQuest commands are embedded in this menu, making the program easy to use. Users can transfer data directly among key programs, allowing report, statement and document flexibility. For example, users can transfer data from reQuest to the word-processing program by merging fields to the existing documents or by creating documents. Users can also transfer data from the DBMS to the Multiplan electronic spreadsheet package developed by Microsoft Corp., from the word processor to electronic mail and from the terminal emulator to the word processor.

The reQuest DBMS automatically converts data from mainframe databases to reQuest formats and allows reports to be generated directly from the menu. It also maintains directories of reports and forms created during system use. It provides multilevel security, maintaining a list of valid users and providing each with a password. In addition, it provides separate security classifications for retrievals and updates, and it limits access to data fields.

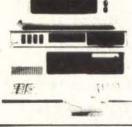
The non-procedural reQuest system uses English-language commands and provides menus, prompts, error messages and embedded "help" functions. A feature called Question Mark Processing lists user-defined fields, valid values and report/entry formats. In addition to CTOS, reQuest is compatible with the MS-DOS and PC-DOS operating systems. Besides Convergent Technologies' hardware, it also runs on the IBM Corp. PC/XT; the NCR Corp. Worksaver system; workstations from Burroughs Corp., Gould Inc., Prime Computer Inc. and Raytheon Data Systems; and the Hewlett-Packard Co. HP150 TouchScreen personal computer. □

Gene Kadish is president and founder of Legal Technologies Inc., a consulting company and a Convergent Technologies Inc. OEM. Previously, he founded Kadish Research & Analysis, a retail consulting concern.

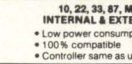
IBM P.C. AVAILABLE PRODUCTS		
	10 MEGABYTE HARD DISK • 100% XT* compatible Boots directly from hard disk • Low power consumption • 10, 22, 33, 87, 240 Megabyte, Internal & External	PORTABLE XT • 10 Megabyte hard disk, fully shock mounted • Tape Back-up in Power Center™ • 640K expansion on mother board using 256K chips NEW • Tape Back-up, 1/2 height (floppy tape) • 640K expansion on mother board using 256K chips • 20, 40, 60 Megabyte tape back-up • Economical, fast, reliable NEW
IBM P.C. AT AVAILABLE PRODUCTS		
	• Optional 2nd hard disk or removable hard disk for backup • CMI 20/30 Megabyte hard disk (Same as used by IBM) • 20, 40, 60 Megabyte 1/2 height Tape Back-up Very fast, efficient & reliable • Removable hard disk 10 Megabyte	EXPANSION BOARDS AT RAM CARD • 128K expansion, 1.5 Megabyte using 256K chips NEW • 128K Piggy Back Chips for mother board expansion AT I/O • Serial Port RS232 & • Parallel Port • Fully IBM AT compatible
COMPAQ DESK PRO AVAILABLE PRODUCTS		
	HARD DISK 10, 22, 33 MEGABYTE • Fully compatible	TAPE • D.O.S. 2.1 & 3.0 compatible • 1/2 height • 20, 40, 80 Megabyte • Standard data format • Image or file by file • 10 Megabyte (Floppy tape) • Same as used by Compaq
COMPAQ PORTABLE		
	10, 20, MEGABYTE HARD DISK • Low power consumption • Special shock mounted (Same as used by Compaq)	RAM UPGRADE • 640K expansion on mother board using 256K chips
AT & T AVAILABLE PRODUCTS		
	HARD DISK 10, 22, 33, 87, MEGABYTE INTERNAL & EXTERNAL UNITS • Low power consumption • 100% compatible • Controller same as used by AT & T	TAPE • External Tape Back-up in Power Center™ • 10, 20, 40, 60 Megabyte
RAM UPGRADE • 640K expansion on mother board using 256K chips		
YOUR ONLY SOURCE FOR IBM PC, XT, PORTABLE, AT, COMPAQ PORTABLE & DESK PRO, AT & T UPGRADE KITS, HARD DISKS, TAPE BACKUP, RAM UPGRADES & EXPANSION BOARDS. <small>*IBM, PC, XT, and PC AT are trademarks of International Business Machines Corporation. **Disk Pro is a trademark of Compaq Computer Corporation.</small>		
ONE CALL DOES IT ALL! (714) 953-0470 1512 E. Edinger Ave. • Santa Ana, CA 92705		

CIRCLE NO. 35 ON INQUIRY CARD

Interest Quotient (Circle One)
High 456 Medium 457 Low 458

Other terminals will hide their screens in shame



When you see TAB's new E-32 Display Terminal

The video qualities of this new Smart Ergonomic Terminal are the finest available. TAB's high resolution, non-glare, 15-inch green screen produces crisp, readable characters in both 80 and 132 column modes.

The E-32 has a display performance that makes your whole computer system look better. Plus it has built-in flexibility that allows TAB to quickly customize to OEM and System Integrator's specifications.

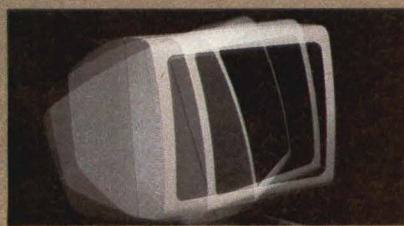

Ergonomics that make your customers comfortable. The E-32 screen tilts and swivels on its base for ideal viewing. A detached, lightweight keyboard features sculptured, stepped keys—and a low profile for hand, arm and back comfort.

Compatible with most computers in the industry. The E-32 is fully ANSI 3.64 compatible and communication compatible with DEC VT 52*, VT 100* and VT 132* terminals. Uniquely, it can memorize over 50 set-up parameters for each of three different computers, to be recalled at the touch of a key.

A terminal that adapts to your application. It was designed to be flexible for change. Keys can be added, moved or removed. In addition to a variety of character and line attributes, the E-32 has eight soft function keys that control more than 100 parameters of set-up and operation.

Room for expansion. Modular software design means the E-32 offers flexibility with a simple change of PROMs. The terminal housing can support an additional circuit board to add features such as internal modems.

Select the options your customers need. Options include amber or white CRT, memory expansion to 4 pages, serial and parallel print ports, internal modem and composite video.

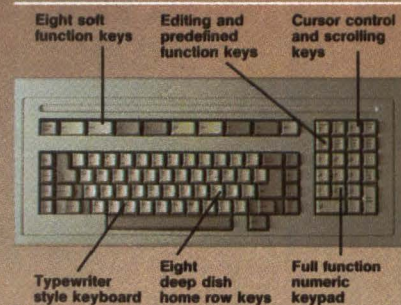

The E-32 is backed by 35 years experience in building and servicing quality products. See how it can enhance your systems capabilities by calling (800) 672-3109 Ext. 4304. In California (800) 742-0099 Ext. 4304. Or write us at 1400 Page Mill Road, Palo Alto, CA 94304. In Canada, 550 McNicoll Avenue, Willowdale, Ontario M2H 2E1.

*Trademark of Digital Equipment Corporation.

TAB PRODUCTS CO. TECHNOLOGY AND BUSINESS
 TERMINALS ■ COLOR-CODED FILING SYSTEMS ■ MOBILE SYSTEMS
 FILING EQUIPMENT & SUPPLIES ■ FORMS PROCESSING EQUIPMENT
 COMPUTER ACCESSORIES & SUPPORT FURNITURE ■ WORKCENTERS

CIRCLE NO. 36 ON INQUIRY CARD

Our brain

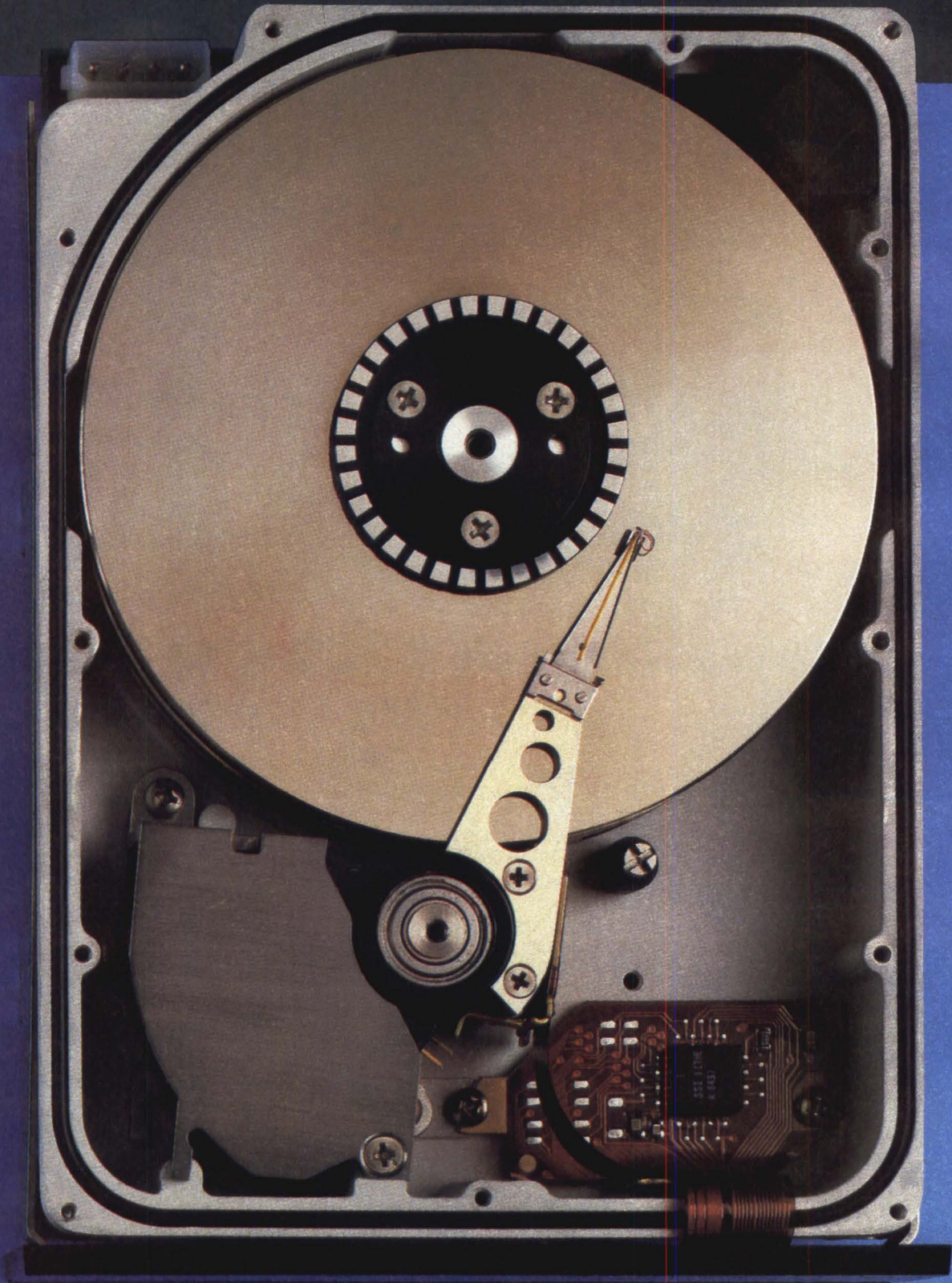

child.

Announcing the Q200™ intelligent disk drive.

The first half-high, 5¼-inch disk drive with the brains and the capacity (53 and 80MB, formatted) to outwit high costs now, and in generations of systems yet to come. And the first disk drive smart enough to step beyond simply enhancing peripheral functionality, to improving total system performance.

We combined the drive and controller as a fully functional mass storage unit to give you a number of advantages. Controller/drive interfacing problems are eliminated, and it takes a lot less time to test and integrate a single component.

The Q200 has its own media defect and error-handling capability, so it not only recognizes errors, but is clever enough to correct them itself. That means a major savings of time and work at your end, with no defect mapping to worry about.

With the SCSI interface, the Q200 breaks through the limits of existing drive technology, into a new way of thinking about system architecture as a whole. Your system no longer has to be designed and redesigned to accommodate a mixed bag of peripheral interfaces. System upgrades will no longer mean expensive hardware and software overhauls.

And like every Quantum drive that's come before it, our latest brain child was born to run longer, on less power, with fewer parts. This lean breeding not only delivers more in your system, but makes it possible for us to deliver the Q200 to you in very high volumes. At prices that will make this baby look very, very smart, indeed.

Please call us for more information.

Quantum Corporation, 1804 McCarthy Boulevard,
Milpitas, CA 95035, (408) 262-1100. TWX 910-338-2203.
Eastern Regional Sales Office: Salem, NH (603) 893-2672.
Western Regional Sales Office: Santa Clara, CA (408)
980-8555. European Sales Office: Frankfurt, West Germany
069-666-6167. Quantum products are distributed in the
United States and Canada by Arrow Electronics.

Quantum

CIRCLE NO. 37 ON INQUIRY CARD

To get the world's most advanced 50 CPS daisywheel printer, you'll have to pay less.

The TeleVideo® 750 delivers 50 CPS performance using an incredible 40% fewer parts than any comparable printer. So it's no mere coincidence that the 750 sells for up to 40% less. With quality so good, you can produce camera ready copy directly.

Cost of ownership gets even better with time. Fewer parts equal more reliability: an average of 65,000 pages between failures. And with the works in a drawer, repairs — when necessary — are quick and easy.

Fewer parts also equal a low profile, small footprint, and light weight. The TeleVideo 750 printer is plug compatible with almost every computer system. And TeleVideo provides a complete selection of supplies and paper handling accessories.

You won't find a printer better suited than the TeleVideo 750 to an office environment. So if you're responsible for printer purchase decisions, the TeleVideo 750 should make your job significantly easier. Now there is a daisywheel printer that gives you high performance, low cost and excellent quality.

For information about TeleVideo Printer dealers in your area or a free demonstration, call 800-521-4897. In California 800-821-3774.

Regional Sales Offices: Schaumburg, IL (312) 397-5400, Norcross, GA (404) 447-1231, Waltham, MA (617) 890-3282, Syosset, NY (516) 496-4777, Irving, TX (214) 258-6776, Irvine, CA (714) 476-0244, San Jose, CA (408) 971-0255.

CIRCLE NO. 38 ON INQUIRY CARD



Printers
TeleVideo Systems, Inc.

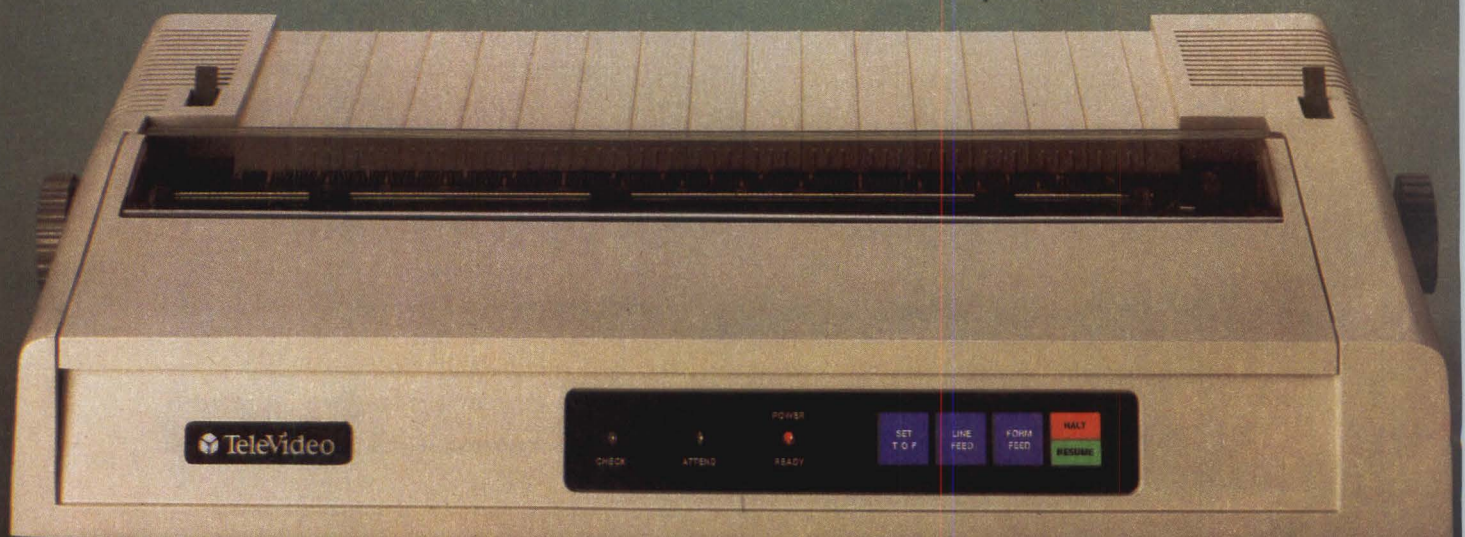

VERTICAL MARKET INTEGRATOR

NETWORKED PCs IMPROVE HOSPITAL'S HEALTH

Using a microcomputer network, a small hospital automates admissions, discharges, pharmacy transactions and even patient diagnoses

Robert A. Sehr

Whidbey General Hospital is a 50-bed facility in the island community of Coupeville, Wash., some 40 miles north of Seattle across Puget Sound. Until recently, the hospital had limited health-care resources. When the people of the community needed extensive care, they would go to a hospital on the mainland.

Yet, this small-town hospital is experimenting with using a network of IBM Corp.-compatible PCs to serve its patients with an efficiency nearing that provided by the minicomputers typically used in larger hospitals. The hospital is acting as a beta test site for a hospital-management system configured by Medical Management Information Systems Inc. (MMIS), Seattle, an OEM for TeleVideo Systems Inc., Sunnyvale, Calif. The system, based on the TeleVideo Personal Mini/16 (PM/16) microcomputer network system, tracks doctors, patients, pharmacy operations and medical records. "A system like this would usually cost at least \$1 million—more than we could afford," says Whidbey General's assistant administrator, Robert Maxwell. "By using a microcomputer, we can install it for one-tenth the cost [of a minicomputer]."

Network updates hospital

Whidbey General decided to buy the PM/16 after the service bureau that had been doing the hospital's bookkeeping went out of business a year ago. When that happened, hospital administrators had to decide whether to find another service bureau or buy a computer system. They decided to buy a computer system—and they wanted one that did more than just accounting—because they believed that such a system would be more cost-effective than using a service bu-

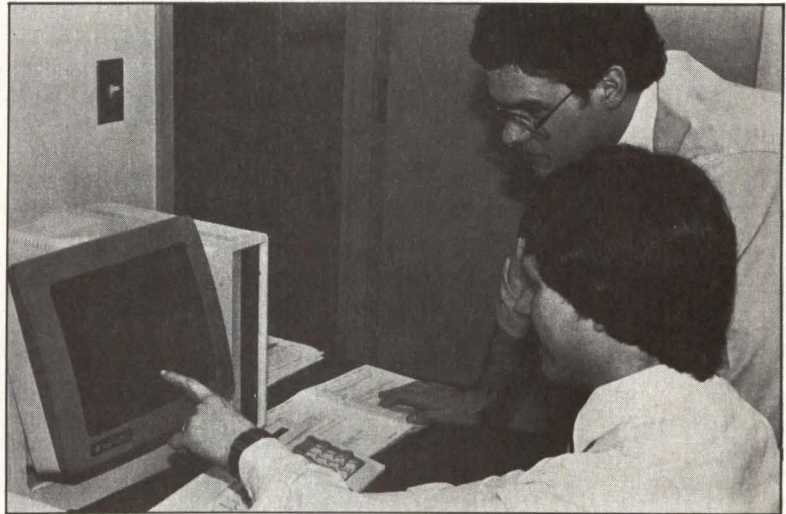

reau. In addition to considering cost, the hospital needed a system that offered efficient order entry, database management and file security.

The hospital administrators came across the MMIS-configured PM/16 after evaluating supermicrocomputers and minicomputers, and found in the PM/16 the solution they had been looking for—a low-cost hospital-management system. What's more, the system's interface card allows users to network PCs inexpensively—another important factor in Whidbey General's decision. For its part, MMIS saw Whidbey General as the beta test site it had been looking for to "fine tune" the system.

The centerpiece of the network, the 16-bit, multiuser PM/16, uses a dedicated file server with a 40M-byte hard disk and a 740K-byte floppy disk. With the \$99 PM interface card from TeleVideo, users can connect as many as 16 IBM PCs or compatibles or as many as eight diskless

At Whidbey General,
personnel use a TeleVideo PM/16 to track patients' diagnoses and progress.

Using Data Access' Dataflex database-management system, the PM/16 tracks patient admissions and discharges, medical records and surgeon and operating-room scheduling.



workstations to the server. The PM/16 uses TeleVideo's InfoShare operating system, a customized version of Novell Inc.'s NetWare that runs multiuser applications, thus allowing more than one user at a time to work with a shared file. InfoShare can run programs written in MAI/Basic Four Business Products Corp.'s Business BASIC and Ryan-McFarland Corp.'s RM/COBOL, as well as single-user applications for the IBM PC.

Whidbey General is using two PM/16s connected to 15 diskless workstations. Eventually, the hospital will increase the number of workstations to 20. The PM/16 can generate most hospital functions using the Dataflex database-management system developed by Data Access Corp., Miami, and customized by Whidbey General employees and MMIS. The customized version provides such functions as patient admissions and discharges, medical-records tracking and surgeon and operating-room scheduling. Dataflex also maintains pharmacy inventories, generates pharmacy records, tracks the location of patient charts and generates physicians' personnel records for administrative files.

Order entry aids accounting

Using Dataflex's order-entry system, hospital personnel can track requests for lab work from the time a physician or nurse enters the requests until the laboratory performs the work. Within minutes after the lab reports the results of a test, the system makes these results available to doctors on their terminals or on printouts. The system automatically flags abnormal test results, so doctors can quickly spot and treat serious maladies. Before the installation of the PM/16, hospital personnel had to hand-deliver the lab requests and reports to the various departments in the hospital. "It used to take days for the reports to make their rounds from request to billing," says assistant administrator Maxwell.

The Dataflex system automatically generates a

billing file for the accounting department and a hard-copy bill for the patient. The PM/16 communicates with an IBM System/36 minicomputer, which tracks accounts receivable and accounts payable. Hospital administrators plan to buy a third PM/16 file server eventually to take over the accounting function currently performed by the System/36.

Whidbey General administrators expected some "computerphobia" among the staff. To combat this, they phased in the system department by department, enabling the administrators and users to learn from experience. So far, the hospital staff has been pleased with the system, Maxwell says. Once users familiarize themselves with the system, most of them like its speed and efficiency. The nursing staff in particular appreciates the system because it has taken over some of their clerical responsibilities, freeing them for the more important task of caring for patients.

The nurses also have more time to make decisions concerning patient care. For example, one of the nurses worked with MMIS to plan the PM/16's patient-care database software. A modern equivalent of a typical hospital chart, the patient-care system tracks prescribed tests and medication for each patient. The software writers did not alter the Dataflex software except to create records and fields.

Because the patient-care records contain confidential information, it was important that the PM/16 provide adequate file security. Improper access to a multiuser system in a hospital could cause medication mistakes or even a patient's death. In the PM/16s, the InfoShare operating system provides true file- and record-locking capability. Using passwords and flags, it restricts access by preventing certain users from reading or writing to a file or record. As a result, only doctors might have access to some records, while only pharmacists might have access to others. Still other records would be accessible to all authorized system users. In addition, the PM/16 does not partition disks, so users need not flag a set amount of space.

The PM/16 server alone sells for \$8,995. An expansion unit, including eight diskless workstations, adds \$4,995 to the price. □

Robert A. Sehr, a former associate editor for *Mini-Micro Systems* magazine, is now a free-lance writer based in Sunnyvale, Calif.

Interest Quotient (Circle One)
High 459 Medium 460 Low 461



Introducing a modem that speaks highly of you.

If you're an OEM looking to hook up with a modem supplier, we not-so-modestly suggest you talk with us.

E+E DataComm.

We're the company behind the increasingly popular Avatex™ line of modems.

Popular because they're designed with all the reliability OEMs, systems integrators and end-users alike have come to expect from a serious piece of communications equipment.

But that's only half the story.

Because behind *us* is Elec and Eltek, whose 15 years as a worldwide supplier of PCB and telecommunications products has taught us a thing or two about the OEM market.

Like how to develop a level of auto-

mation at both manufacturing *and* test stages so sophisticated as to dare approach zero defects.

That same penchant for perfection is reflected in our prices. They're competitive. Very competitive. And our delivery commitments—firm.

The result of all these efforts is an OEM support program that surpasses conventional programs to such a degree as to make them inapplicable.

So, if you want to put your reputation on a better line of communication, put it on E+E DataComm. It'll say a lot about you.



E+E DataComm

2115 Ringwood Avenue, San Jose, CA 95131
800-4-AVATEX

Avatex is a trademark of E+E DataComm, U.L./C.S.A. & FCC Part 15 and 68 approved. Copyright 1985 E+E DataComm.

CIRCLE NO. 39 ON INQUIRY CARD

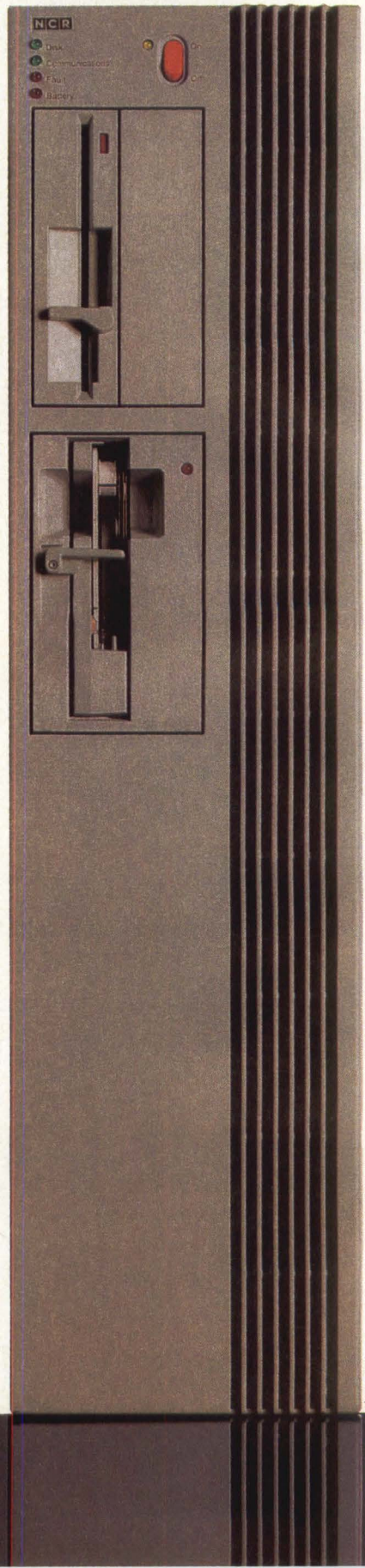
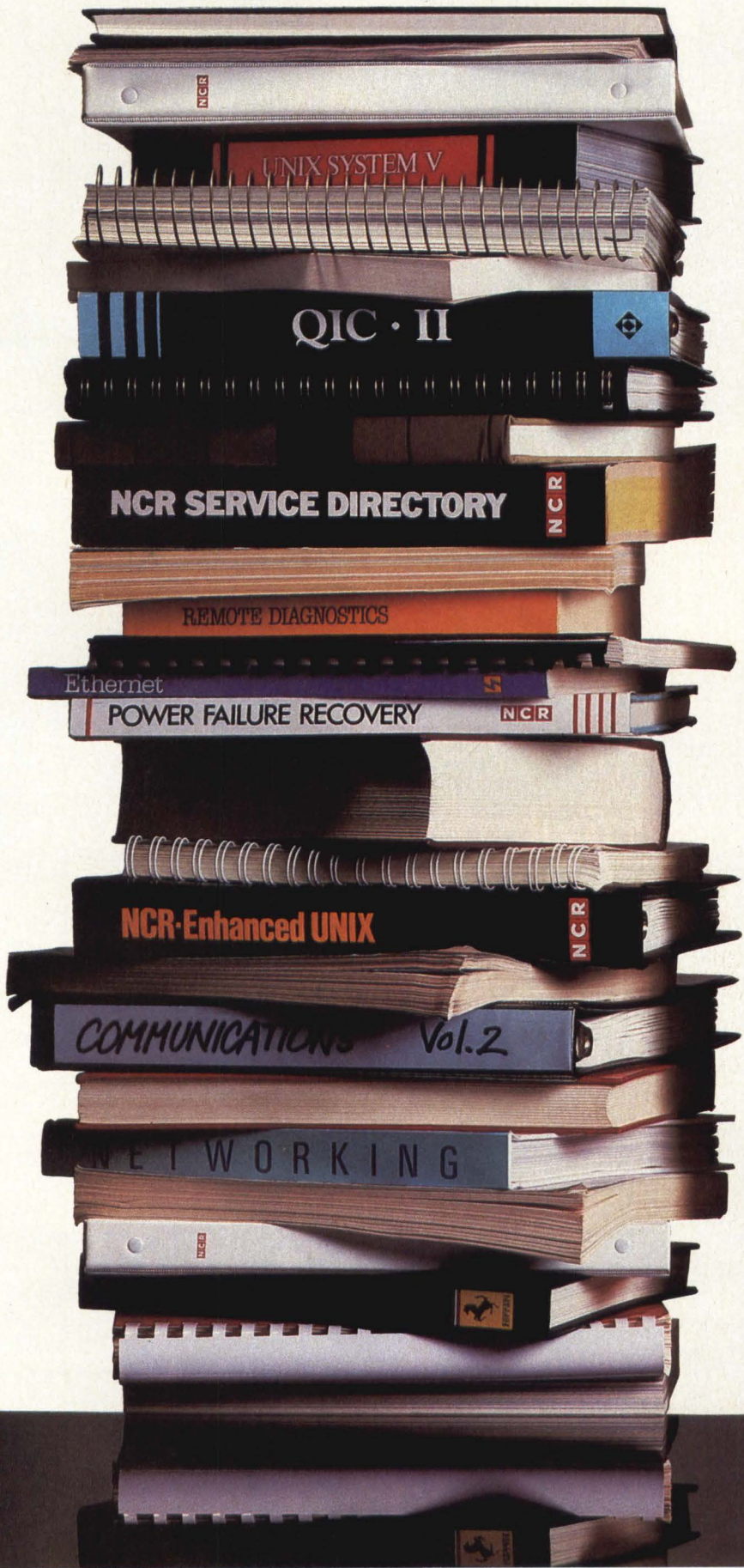

TOWER XP. THERE ARE OTHERS IN THE CLASS, BUT THEY'RE JUST HERE TO LEARN.

The most popular school of thought in the computer industry today holds that a computer system's value is directly proportional to the number of bells and whistles tacked onto it.

NCR took a different, more pragmatic approach in designing the Tower® XP.

Of course we designed in highly advanced NCR features.

A powerful Motorola 68010 CPU. Consistent error-logging. Extensive in-service and remote diagnostics. Automatic Power Failure Recovery. An NCR-enhanced UNIX* that virtually never PANICs. Local area networking (LAN). The most complete communications package of any comparable system, including X.25 and SNA/SDLC. And much more.

But thirty years in the computer industry has taught us that there are even more enduring qualities vital to OEMs.

Innovation. Reliability. Service.

NCR spends thousands of hours and over a quarter of a billion dollars on R&D every year to assure that NCR products are of unmatched innovation and reliability. And over 400 field service offices nationwide guarantee you fast service if there is ever any problem.

NCR's commitment to systems builders. It puts Tower XP in a class by itself.

**TOWER XP.
BUILT FOR SYSTEMS BUILDERS
BY NIT-PICKING FANATICS.**

NCR

OEM Systems Division

CIRCLE NO. 40 ON INQUIRY CARD

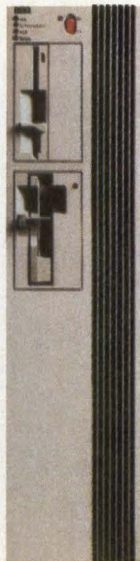

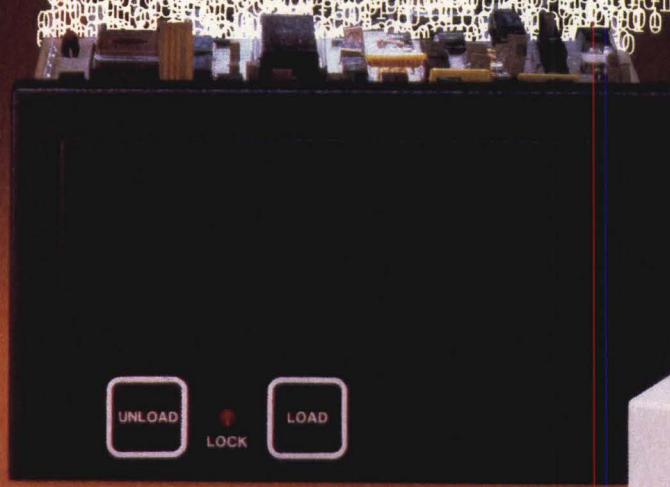

The STR[®]-STREAM II 1/2" Tape Drive.

130 million bytes can't be wrong.

If you've got a lot of data to backup off your system hard disk (up to 130 Mbytes) and can't afford a lot of time to make sure it's done accurately, then you should take note of the new EPI STR-STREAM II 1/2" cartridge tape drive. It features 130 Mbyte capacity in a single 1/2" tape cartridge, one of the lowest cost-per-megabyte figures of any competing mass storage device, and the proven accuracy of reel-to-reel technology.

The screamin' streamer.

You get an almost unbelievable 225 kbytes/sec transfer rate. That coupled with an EPI controller means it can operate continuously in streaming mode to backup a full 130 Mbytes in under 12 minutes. And deliver a guaranteed bit error rate of less than one hard error in 10¹¹ bits.

Compatibility, innovation, and reliability complete the story.

Tape guide accuracy of ±.001 inch means that tapes can be freely interchanged between any STR-STREAM II drives. And our proprietary multi-bump, constant-curvature head assures accurate and repeatable head-to-tape contact. The drive fits in the same space as a standard 5 1/4" disk drive, operates off the same supply voltages, and features a superior MTBF of 15,000 power-on hours.

For more information on the STR-STREAM II 1/2" cartridge tape drive, call us today at (303) 761-8540, or write Electronic Processors, Inc., 1265 W. Dartmouth Ave., Englewood, CO 80110.



"Let EPI remember for you."

CIRCLE NO. 41 ON INQUIRY CARD

See us at NCC '85, Booth #'s 1205 & 1206

FEATURE HIGHLIGHTS

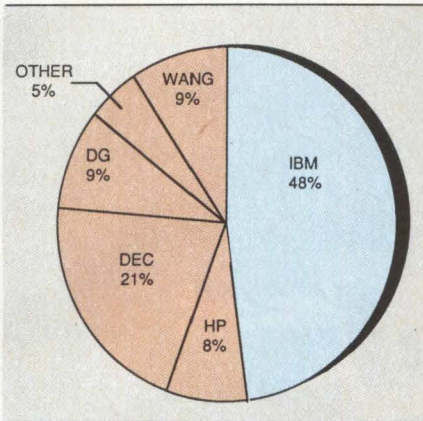

p. 84 IBM controls market

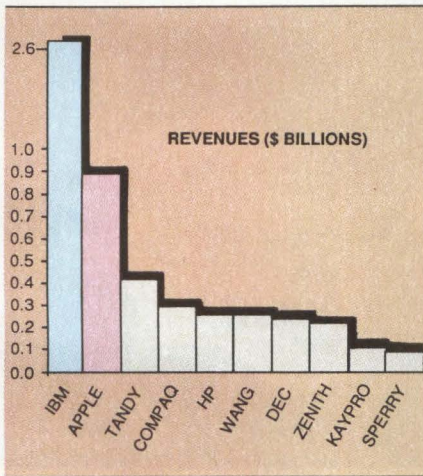

p. 123 . . Office market still booming



p. 153 See you in Chi-town

PERSPECTIVE: 'POWER PYRAMID' AND IBM CONTROL MARKET 85

Many companies are relying increasingly on venture capitalists, public relations companies and the trade press, which together comprise the "power pyramid." This triad in turn rests precariously on a base of often-questionable market research. However, the largest single market influence is still IBM.

LOCAL AREA NETWORKS: DEMAND, NEW PLAYERS BOOST LAN MARKET 97

Local area networking is one of the hottest topics in the computer industry and promises to remain so through the rest of the year. But it looks as though a shakeout is imminent as the telecommunications giants begin to make bold moves into the LAN market.

PERSONAL COMPUTER SOFTWARE: MICRO SOFTWARE PROMOTES EASE OF USE 111

If you've sat through demos of the new personal computer software offerings, you'll agree that the main goal is rich functionality with ease of use.

PERSONAL COMPUTERS: IBM, APPLE RULE OFFICE MARKET 123

One research firm expects the market for office personal computers to grow from \$6.6 billion in 1984 to \$30 billion by the end of the decade. Two companies are issuing the orders, while a phalanx of others form the rank and file.

TAPE DRIVES: IBM ENTRY SPURS HIGH-END TAPE DRIVE MARKET 137

Tape drives rarely enjoy the technological wizardry afforded the disk drive industry, but an entry from IBM this year marks a new level of sophistication for tape technology, which will undoubtedly spur the market for 1/2-inch tape cartridge drives. Meanwhile, the 1/4-inch tape drive market is streaming along.

VALUE-ADDED RESELLER MARKET: VAR CHANNEL SKIRTS RETAIL LOGJAM 147

Reacting to the crowded retail marketplace, many manufacturers are seeking alternative distribution channels. One fast-growing route is the value-added reseller, who often sells into niche, or vertical, markets.

NCC PREVIEW: NCC PANELS STRESS INTERNATIONAL OUTLOOK 153

This year's National Computer Conference — July 15 to July 18 at Chicago's McCormick Place — will feature over 700 exhibitors and 80 technical sessions. Focus topics include the international market, AI and networks.

Plotter graphics prevent boardroom boredom

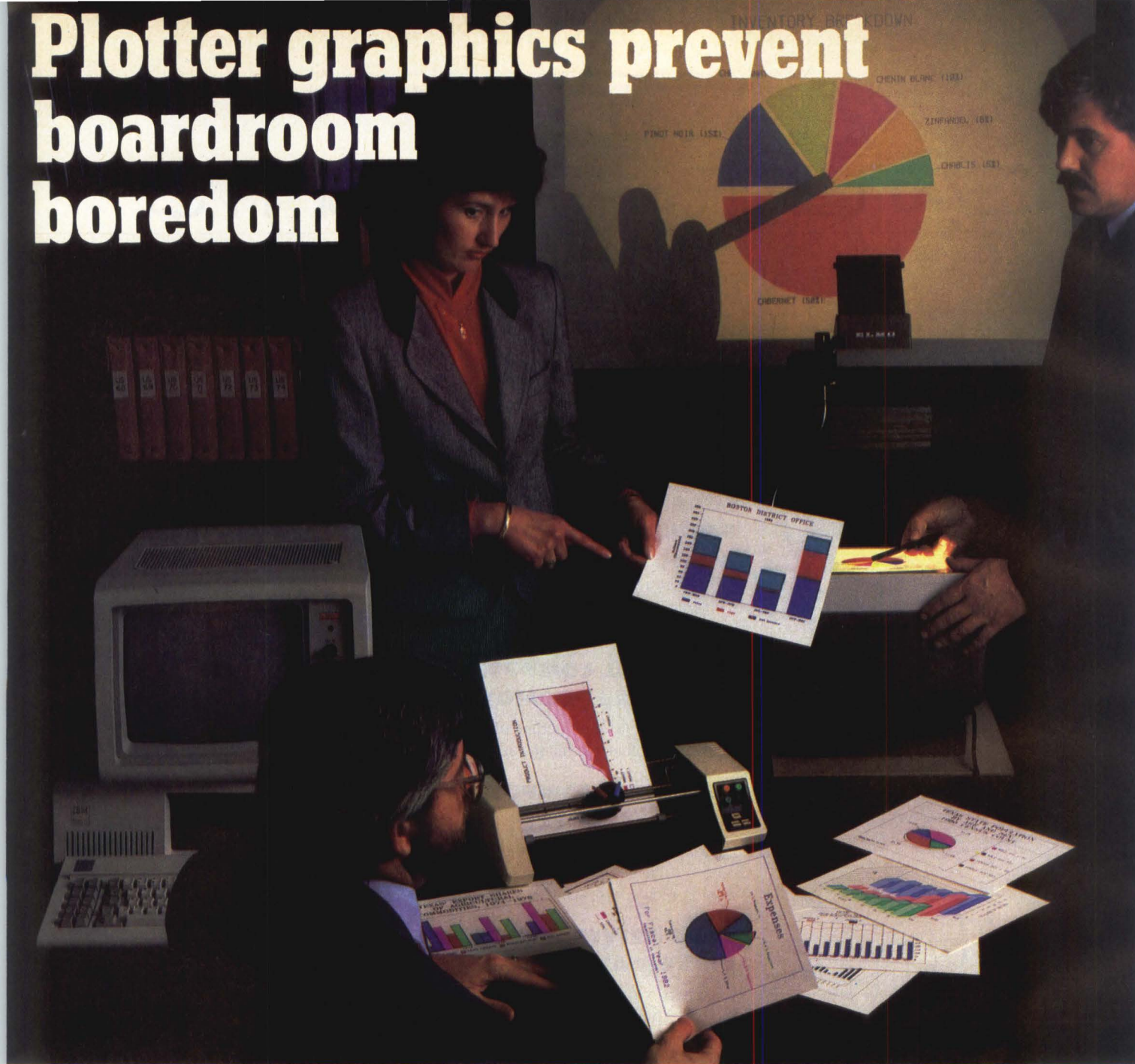

Crisp, clean, hardcopy graphics make dramatic impressions. Now, with Houston Instrument's **PC Plotter**, you have an affordable way to link the power of graphics to your personal computer. The **PC Plotter** produces quality graphics at a price you won't mind paying. It allows you to produce vibrant line, bar, and pie charts using eight different colors on either paper or overhead transparencies. And you can create either 8½" x 11" or 11" x 17" graphics.

Whether you're a computer wizard or novice, the **PC Plotter** is simple to operate and can be used with virtually any computer on the market today. Plus, your graphics software choices are unlimited. Houston Instrument products are supported by a versatile collection of more than 250 graphics software packages.

For example, just take a look at the above photo and you'll see plots created by PFS:® Graph, Lotus® 1-2-3,™ Peachtree Business Graphics System,™ Design Intelligence,™ Energraphics,™ and Smart Spreadsheet with Graphics.®

Make the most out of owning an IBM,® Apple® or other personal computer. Give it a **PC Plotter**. . . and give your presentations the visual advantage you need to win in business.

Visit your authorized Houston Instrument dealer or local computer store today and ask for a demonstration of the **PC Plotter**. For more information, call us at 800-531-5205. Texas residents may phone (512) 835-0900. Houston Instrument products are designed, marketed, and manufactured in Austin, Texas.

Visit us at NCC Booth #5063

CIRCLE NO. 42 ON INQUIRY CARD

houston
instrument

4P019

'POWER PYRAMID,' IBM CONTROL MARKET

Venture capitalists, public relations companies and the trade press exert strong influence on most segments of the industry, but the largest single influence remains IBM

Gene R. Talsky
Contributing Editor

By the end of the decade, medium and small businesses will surpass big corporations as the largest markets for small business systems and office automation products. However, these markets remain the most difficult and costly for computer hardware, software and service vendors to reach. IBM Corp., freed in court from the threat of governmental regulation, is committing unprecedented resources to capture the major share of this market. Other companies addressing these markets find themselves increasingly dependent upon venture capitalists, public relations companies and the computer trade press for success in both direct and indirect marketing. These three groups now comprise a "power pyramid" that exercises sufficient influence to determine the success or failure of all but the largest vendors.

Venture capitalists take charge

Venture capitalists are no longer passive sources of financing for start-ups and young companies. Most of the venture capitalists participating in a recent seminar admitted to using their financial position to replace the founding management in 30 percent to 50 percent of their portfolio companies. In a growing number of cases, venture capitalists are actually assuming the responsibility for managing their investments themselves. Additionally, investors are increasingly attempting to influence new entrants to

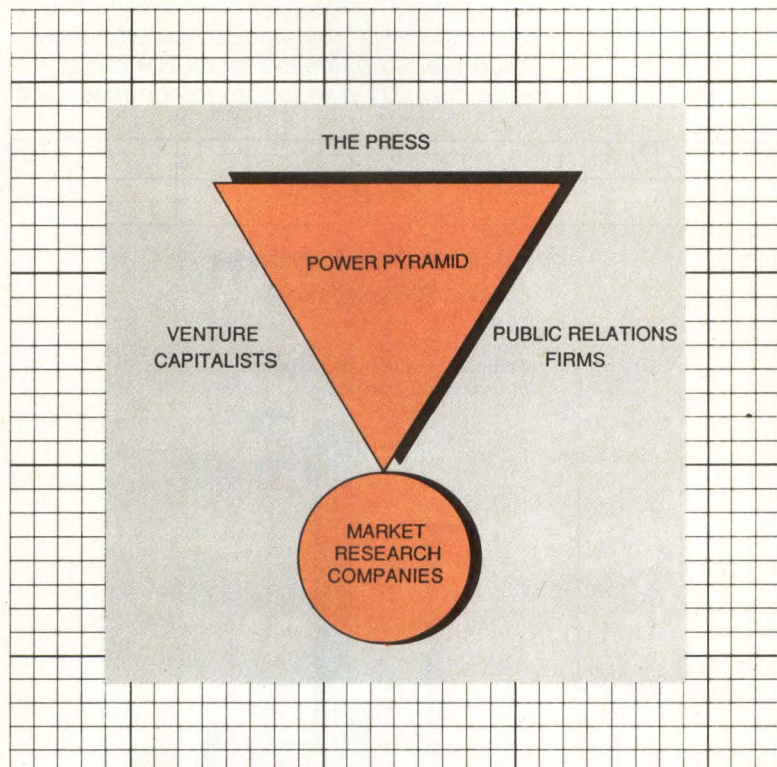

The "power pyramid"—comprising the trade press, public relations firms and venture capitalists—exercises sufficient influence to determine the success or failure of all but the largest manufacturers. Rather than sitting on a firm foundation, however, the pyramid is inverted precariously on a base of market research that often has little strength on which to build structural support.

merge their talents or products with one of the investor's existing clients, in order to bolster management or address a market weaknesses.

Furthermore, by withholding previously committed additional financing—typically justified by a company's failure to attain projected revenues and earnings—venture capitalists are gaining financial and operational control of companies at an unprecedented rate. Unfortunately, venture capitalists are not necessarily the best managers of high-technology companies, and rarely do they have the marketing expertise required in such highly competitive arenas. The number of venture capitalists who are seasoned managers with successful track records is extremely limited.

Venture capitalists' need to protect their investments and minimize losses is understand-

Reported buying plans of companies with installed minicomputers indicate that loyalty is high among owners of IBM equipment. For example, among approximately 2,600 companies with IBM minicomputers, about 2,400 plan to purchase more IBM minis, while only 200 plan to turn to non-IBM vendors.

able. However, in most instances, assuming active management roles in high-technology industries in which they have insufficient expertise is not proving beneficial to them or to the principals of their portfolio companies.

PR power grows

Selling high-technology products in a highly competitive environment has elevated marketing from a support function to a science. Market penetration and market share are the primary goals of all vendors. Their need to identify and address their markets requires more than full-page, four-color ads in the appropriate business journals. Sophisticated marketing plans are implemented well before a company is ready to sell a particular product, in order to generate growing interest and excitement as the introduction date draws near.

Marketing programs address three primary targets: the financial community—including venture capitalists, investment bankers and other institutions—to attract the money for development and marketing; resellers—including distributors, dealers, integrators and OEMs—to develop the multiple distribution channels needed to reach large, medium and small businesses; and the business press, whose influence on markets continues to grow. The buyer is often the secondary target of these marketing campaigns.

A handful of high-technology public relations companies, such as Franson and Associates Inc., Miller Communications, Regis McKenna Inc. and Simon/Public Relations Inc. are proving themselves masters of the art of high-technology marketing. They start promoting companies and products long before product availability; carefully orchestrate product introduction; and nurture the financial community, the press and resellers as the product nears delivery. Their great risk is the possible failure of their clients to deliver products. Ovation Technologies Inc. stands out as one of the more recent examples of failed marketing expectations. The Canton, Mass., company was launched with great expectations in 1983 and was in financial ruins in little more than a year. It never produced the business software it had promised.

But not least, the trade press

The trade press remains the single most influential force on the market. However, editorial policy is increasingly being influenced by shrinking advertising revenues as vendors' budgets are cut back and competition among publications increases. The trade press sometimes favors po-

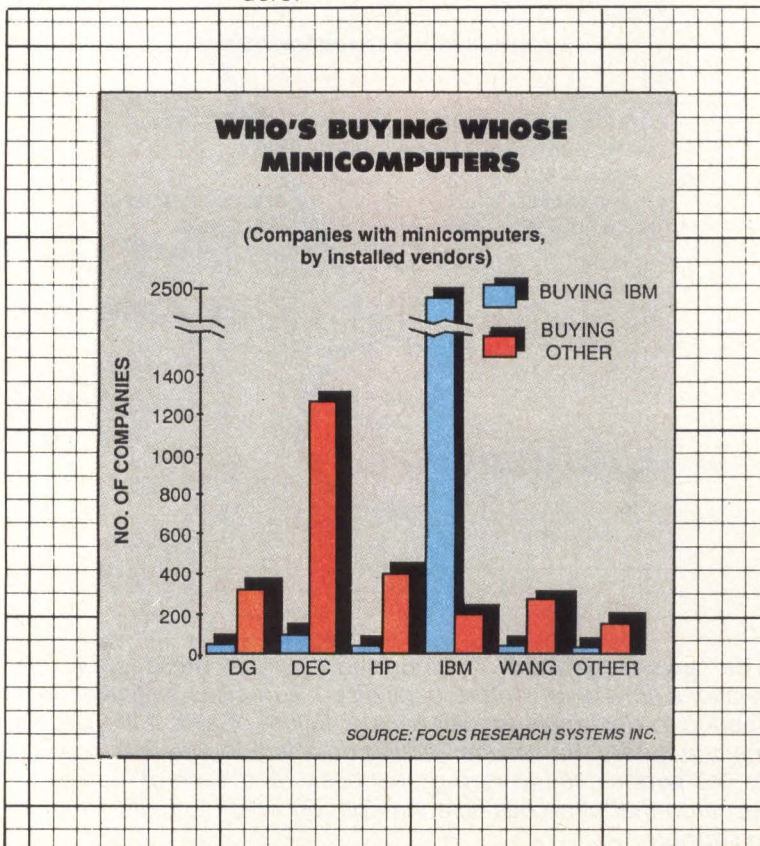

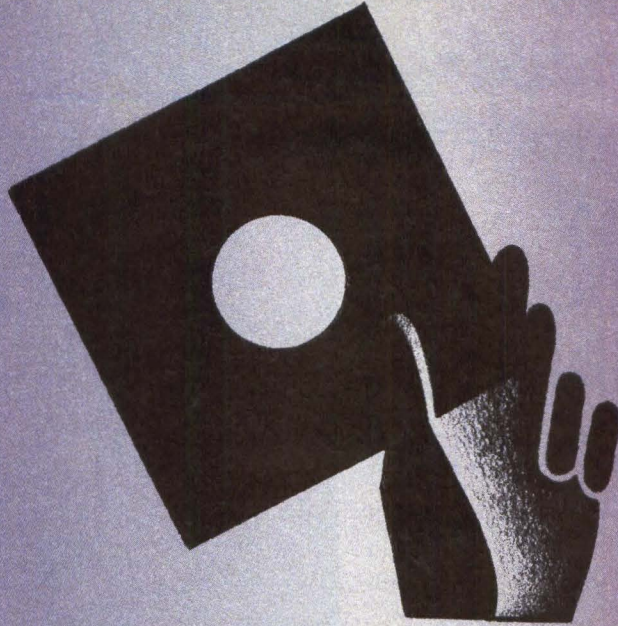

Dick Bard
AND KNOWLEDGEMAN



Most people are satisfied doing one thing well. Not Dick Bard. He runs a successful construction company *and* a successful software design firm.

Fortunately, he has a very hard-working partner: KnowledgeMan.™

"It's a terrific all-purpose tool for designing easy-to-use programs," says Bard, who uses KnowledgeMan to write software for everything from home building to hospitals. "You can design beautiful, user friendly screens; programs that are very simple to follow. And they're a pleasure to write.

"KnowledgeMan puts very few restrictions on the programmer. You don't have to stop and ask yourself, 'Will the system let me do this? Will it let me open as many tables as I want? Will it let me bring in an array if I need it?' It lets you create them on the fly. It's wonderful.

"I considered Lotus™ and Framework™ KnowledgeMan is more logical—far more powerful, too. And it thinks the way I do."

If you're interested in forming a great partnership with KnowledgeMan, contact Micro Data Base Systems, Inc. P.O. Box 248, Lafayette, IN 47902 (317) 463-2581.

A variety of KnowledgeMan options, including K-Text,™ K-Graph™ and K-Paint,™ are available from MDBS.

Current version is 1.07 as of 9/10/84. Operating Systems: PCDOS, MSDOS, CP/M-86. Minimum RAM required is 256K.

Lotus is a trademark of Lotus Development Corporation. Framework is a trademark of Ashton-Tate.



**KNOWLEDGE
man**

The Knowledge Management Software
from MDBS®

LAN Versions Now Available

CIRCLE NO. 43 ON INQUIRY CARD

Fujitsu's Trellis-coded 14,400 bps modem. Quality that's got the best OEMs talking.

Increased data reliability through Trellis coding.

OEMs need fast, reliable modems. And Fujitsu has the right answer: the Fujitsu M1926L stand-alone modem.

It's fast. Transmitting at 14,400 bps. It also operates at fallback speeds of 9600, 7200 or 4800 bps.

It's reliable. With Trellis coding for error-free communications. Erroneous noise is canceled in the receiver because the Trellis-coded modulation in the transmitter adds redundancy to the signal.

Possible bit errors are corrected over the line by a Viterbi algorithm scheme in the receiver. And the M1926L is designed for OEMs only. So your concerns always come first with us.

The Fujitsu M1926L has a built-in, 6-channel multiplexer and operates on four-wire, unconditioned leased lines. In addition to the standard LED indicators, it has a Liquid Crystal Display for easy monitoring of modem operations and tests.

Seven LEDs, six network test loops and an integral test pattern generator and bit error rate detector perform diagnostics without external equipment or remote operators.

This kind of quality and customer care has made Fujitsu a world leader in data communications for more than 20 years. For modems you'll be proud to put your name on, call us at 408-946-8777.



FUJITSU

FUJITSU AMERICA, INC.
DATA COMMUNICATIONS DIVISION
3055 ORCHARD DRIVE
SAN JOSE, CA 95134

CIRCLE NO. 44 ON INQUIRY CARD

STATE-OF-THE-MARKET REPORT: PERSPECTIVE

tential and current advertisers.

The trade press also retains a disproportionate influence on the other two pillars of the power pyramid. Rarely is there a business plan submitted to venture capitalists that does not include copies of favorable product reviews, trade-press interviews with a company's principals or other press coverage. That often includes press clippings that are abbreviated, but otherwise unedited, press releases.

In general, the trade press is less influenced by extravagant entertainment by manufacturers than by editorial and personal bias. Some publications lean more toward certain manufacturers, publishing more about their products and related news, than toward others. Other publications review more favorably products that are easy to learn and to use than products that offer broader capabilities and are, therefore, more difficult to learn and to use.

Topical coverage of trade shows and financial results often reflects editorial bias. One headline might read "50,000 attend ConExpo," while another says of the same event "ConExpo Attendance Down." One publication might report "XYZ Earnings Down," while another, on the same day, proclaims "XYZ earns \$50 per share." These examples, in themselves, do not evidence bias. However, tracking individual publications on a continuing basis makes it easy to follow any ebb and flow of favoritism through article placement and headline wording.

In an ongoing campaign, much of the trade press has lead users to believe that prices of computer hardware and software should continue to be driven down. Editorials and reports have created strong expectations of lower and lower prices, causing many buyers to delay their purchases. Such expectations are often unrealistic, and contribute to the competitive chaos that is forcing so many manufacturers and resellers out of business. Without sufficient profit opportunity, there is no motivation for manufacturers to develop innovative products, or for resellers to offer sufficient support to assure users of success with their computer systems. It is the end users who suffer the consequences when manufacturers and resellers go bankrupt.

In order to retain credibility, the trade press needs to assume greater responsibility for news reports and editorials.

Pyramid rests on shaky research

Rather than sitting on a firm foundation, the power pyramid is actually inverted, with its point balancing precariously on a base of market research that often has little credibility. The prolif-

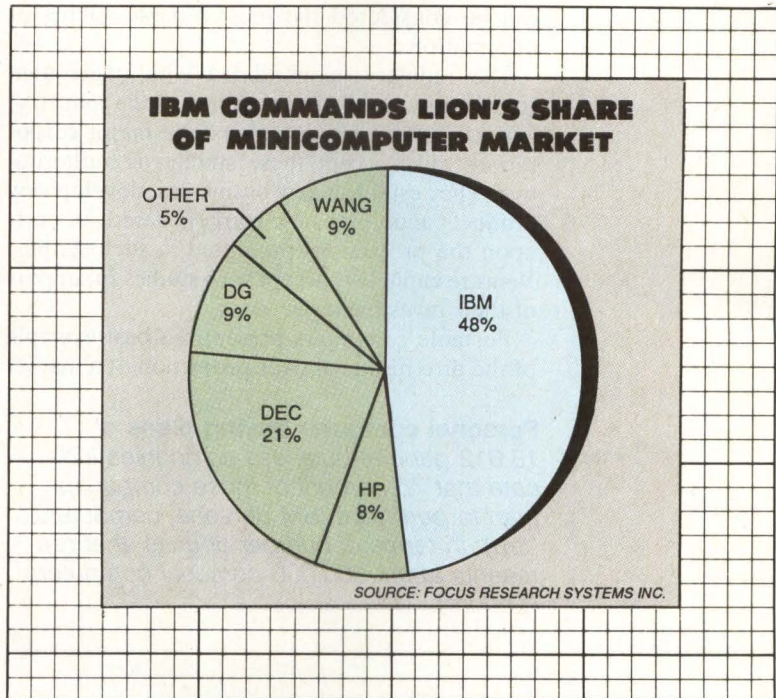

eration of market research companies, along with their reports on computer and office-automation markets, has created a competitive environment that at least matches that of the trade press. The competitive environment often leads to attention-getting reports that are based on shabby research methods. The power pyramid often relies on this specious information.

A handful of well-established research companies, such as Dataquest Inc. and The Gartner Group, have been joined by as many as 100 newer companies, many of which produce studies and projections based upon highly questionable samplings and methodologies. Many of these newer companies, however, well understand the importance of self-marketing and commit substantial budgets to public relations and to promoting their products and services.

Frequently, experience and access to more valid data make it difficult to accept published projections. For example, one study projects personal computer purchases over the next 10 years based upon as few as 170 questionnaires responded to out of 1,000 mailed. Another study, on portable computers, does not even offer any information about its sampling or methodology, other than profiling 23 manufacturers who provided information about their products and technology. Some researchers base their projections on sales figures provided by manufacturers and resellers, neither of whom

IBM minicomputers—which include the Series/1 and System/34, System/36 and System/38 lines—account for 48 percent of the total installed base of minicomputers among 37,508 general-business companies.

STATE-OF-THE-MARKET REPORT:
PERSPECTIVE

can be considered the most reliable source of information.

The industry is inundated with inadequate studies on virtually every aspect of the industry. Unfortunately, entrepreneurs and major corporations alike accept these studies as authoritative. They establish new businesses, develop new products and enter new markets based, in part, upon the projections presented in such studies. Venture capitalists accept such studies in support of their investment decisions.

Portable computers present the best example of the dire results of over-projection of a market

by research reports. More than 150 companies have offered portables; fewer than 40 companies still having some chance of surviving. Hundreds of millions of dollars have been lost in chasing markets that have yet to materialize.

It is important to remember that until an end user actually buys a product, there is no real revenue entering the computer industry. Researchers often ignore this fact and report sales of products that never leave the distribution channels. The fact that a component manufacturer sells to a system manufacturer, who sells to a distributor, who sells to a dealer, who sells to a system house, which may or may not be able to sell to an end user, simply means that many of the reported revenue and profit figures reflect interim economic dust, which, when it settles, ends in bankruptcy for many in the manufacturing/distribution chain.

Few research companies interview or obtain questionnaire responses from enough end buyers to substantiate current and projected usage and purchase reports. One which does, Focus Research Systems Inc., West Hartford, Conn., interviews more than 25,000 companies each month, generating actual usage and planned-purchase information on office-automation and computer hardware, software and services. However, even with a growing database that currently includes more than 200,000 companies interviewed by Focus Research Systems at least once a year, it is careful to qualify the information to prevent false assumptions.

Trade journals also publish market-penetration studies, based upon surveys of their readers. The readers being end users, are influenced in their responses by the products in which they have invested or plan to invest. Additionally, graphs from numerous market studies often appear in business and trade-press publications, without editorial qualification or consideration. Thus the power pyramid balances precariously on questionable market data.

IBM wants it all

The power pyramid influences virtually the entire computer industry with, perhaps, only one exception—IBM.

Even in the mainframe arena, IBM continues to assert aggressive marketing. By targeting a 12 percent growth in their mainframe business in 1985 (as reported in *Business Week* Feb. 18), it may be expecting to capture as much as 90 percent of mainframe sales this year. IBM also shows increasing strength in minicomputer, microcomputer and personal computer markets.

In today's volatile marketplace, buying inten-

Personal computer buying plans of 18,612 general-business companies indicate that 75 percent of those companies plan to purchase IBM personal computers (top). In terms of number of units, that represents about 300,000 personal computers (bottom).

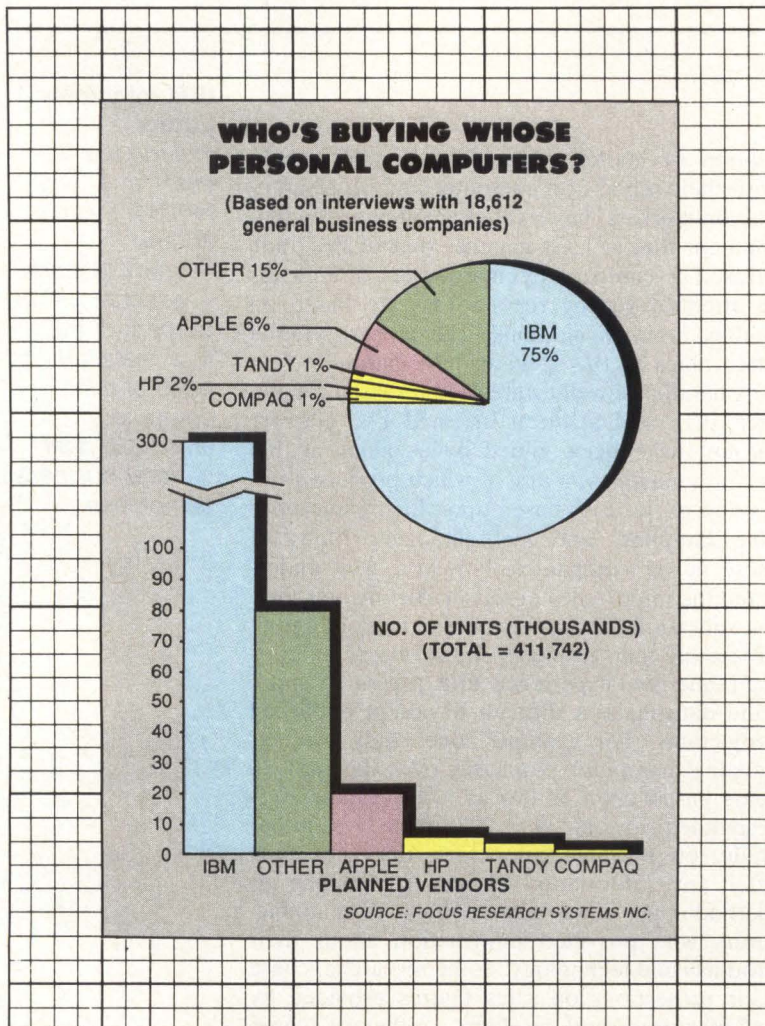

Let
there be
sight

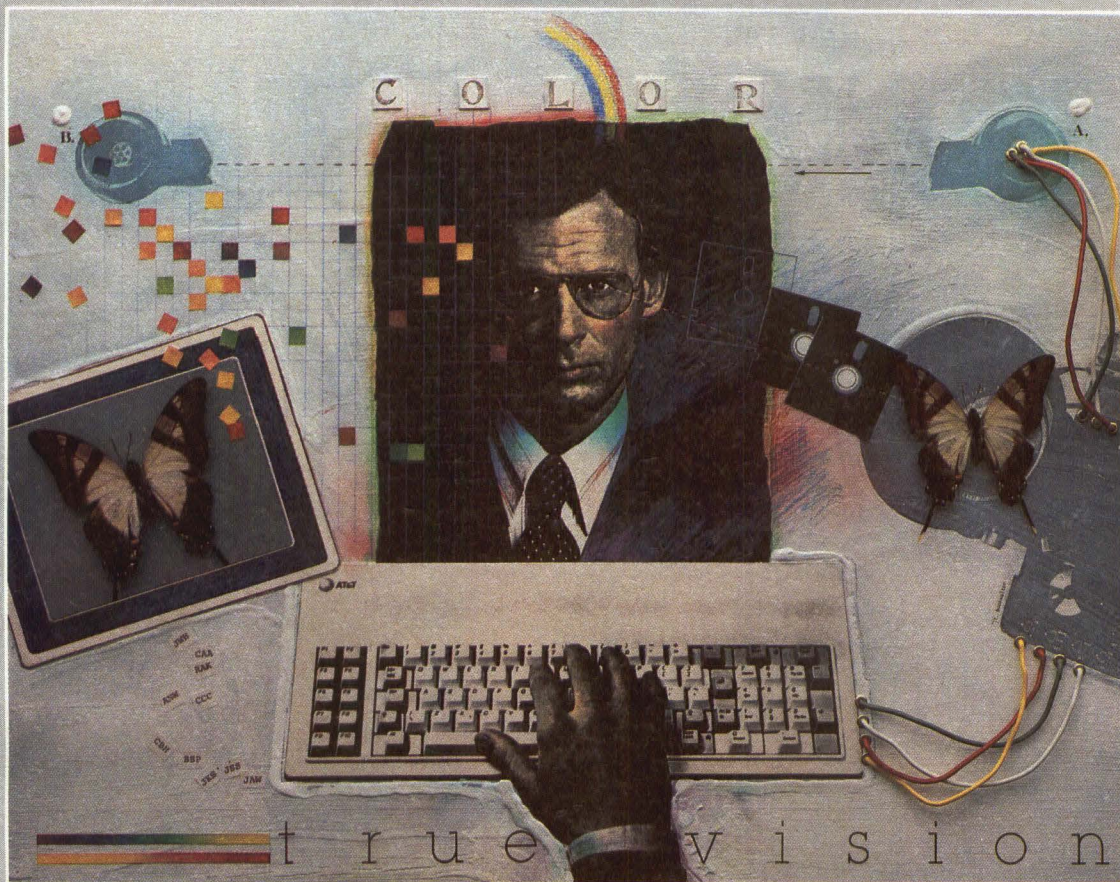

Create a whole new world of uses for your personal computer

A true breakthrough

You've never seen anything like it. New AT&T technology puts real pictures on personal computers. With the same clarity and full-color intensity you're used to seeing on a television screen. It's called Truevision.™ And what you do with it is truly amazing.

True versatility

Now you can grab, digitize and store electronic photographs with a PC in one-sixtieth of a second from a standard video source such as a video camera, VCR, or video disc player. You can overlay text and graphics on these images. Send them to other locations via ordinary phone lines in as little as 15 seconds. Even modify, enhance, merge and

manipulate them in real time.

Now photo files can be stored on PCs. Electronic slide shows can be assembled and operated quickly and easily.

Still-frame teleconferencing and image processing become feasible and affordable.

And you can do it all without a large investment in new dedicated equipment.

True economy

All it takes is the AT&T Truevision Image Capture Board. All it costs is \$1,295 (suggested retail price).

This board can be used with the AT&T PC 6300 or plug compatible personal computers such as the IBM PC, XT, AT, and the Compaq PC.

It digitizes and displays contin-

uous-tone, TV-quality images on analog RGB monitors, composite color video monitors, and color TV sets with RF modulators.

For applications requiring display only capability, the AT&T Truevision Video Display Adapter offers the same image quality at a suggested retail price of \$695.

AT&T also offers two software packages to complete the picture.

The AT&T Truevision Image Processing Software lets you manipulate real images in real time. The AT&T Truevision Business Graphics Software creates high color-resolution graphics from popular spreadsheet programs such as Lotus 1-2-3 and SuperCalc3. It also lets you use your PC to assemble and operate

electronic slide shows quickly and easily.

Truly productive

AT&T has given PCs the gift of sight. With your insight, it can mean new worlds of productivity and efficiency. We've only touched the surface of applications in the marketplace. The possibilities stretch as far as the eye can see . . . and beyond.

If you have an idea, talk to us. We'll help determine its feasibility. And we'll provide tools to help you develop software.

For more information or to place an order, write to: AT&T Electronic Photography and Imaging Center, 2002 Wellesley Blvd., Indianapolis, IN 46219, or call **1-800-858-TRUE**.



AT&T

The right choice.

Truevision is a trademark of AT&T • IBM is a registered trademark of International Business Machines Corporation • 1-2-3 and Lotus are registered trademarks of the Lotus Development Corporation • Compaq is a registered trademark of the Compaq Computer Corporation • SuperCalc3 is a registered trademark of Sorcim/IUS Micro Software.

© 1985 AT&T

CIRCLE NO. 45 ON INQUIRY CARD

Introducing **Human Designed Systems'**
HDS200 Display Terminal Family



**EASY ON
YOUR EYES**

Ended December 31, 1984 1983

Statement Data:

Revenues	\$145,200	\$104,538
Income	14,003	10,266

ings per common share:

132-col. characters actual size

Large, high-density characters make the HDS200 terminal the easiest to work with, even if you work with terminals all day. Our 15" monitor has more viewing area (62% more than competitive screens) so you can work comfortably.

**EASY ON
YOUR SPACE**

A small, one-square-foot footprint lets the HDS200 terminal coexist comfortably with all your desktop tools. A far cry from other 15" displays that dominate your desk.

**EASY ON
YOUR BUDGET**

In addition to the high resolution and small footprint that identify all terminals of the HDS200 family, each display has a unique set of advanced capabilities. The HDS200 ANSI/DEC-compatible terminal — 80/132 columns, 50 user-defined non-volatile keys, smooth scroll, double-high/-wide lines, four pages of memory (optionally eight), windows, viewports, multiple character sets and multiple computer networking. And only \$995.* The HDS200G graphics terminal — all the above plus 720 x 350 high-resolution screen, Tektronix 4010/4014 emulation (also Retro-Graphics, Visual, and others), local printer support with large buffer, and more. For only \$1295.* And there are advanced APL models also.

*Single quantity price. Significant quantity discounts available.

HDS

human designed systems, inc.

3440 Market Street □ Philadelphia, PA 19104
 215-382-5000

It's easy to get your hands on a HDS200 Display Terminal. Call 215-382-5000 or Atlanta: 404-391-9763, Boston: 617-449-6446, Detroit: 313-471-2807, Los Angeles: 213-410-9454, New York Metro: 201-624-1372, Philadelphia: 215-382-5000, Upstate NY: 716-223-4490, San Francisco: 415-692-4184, Toronto: 416-362-1063 or Washington, DC: 301-670-1813 for a free trial in your office.

CIRCLE NO. 46 ON INQUIRY CARD

STATE-OF-THE-MARKET REPORT: PERSPECTIVE

tions provide more insight than do current market share. It is interesting to note that of companies interviewed this year that have non-IBM minicomputers—and that planned to buy one or more additional minicomputers—more than 90 percent planned to remain with non-IBM vendors, according to Focus Research Systems. Of the companies that currently have IBM minicomputers (more than 47 percent of 37,500 companies with installed minicomputers), 93 percent said they planned to buy IBM minicomputers. IBM's enhancements to their System/36 and /38 lines are preserving customer loyalty.

IBM's inroads are most evident in the personal computer arena. Of more than 18,000 companies interviewed—more than 60 percent of which already have one or more personal computers—76 percent planned to buy IBM PCs, 6 percent planned to buy Apple Computer Inc. personal computers, and 2 percent Hewlett-Packard Co. units.

IBM's growing market strength becomes more evident when one isolates those companies that currently have Apples installed. More than half of the Apple users that plan to buy more personal computers plan to buy IBM PCs. Only 22 percent plan to buy more Apples. Even more ominous for Apple is the finding that 25 percent intend to buy personal computers from other vendors. Because Apple aggressively (and shortsightedly) seeks to stop anyone from manufacturing and marketing Apple clones, most of that substantial market share will probably go to IBM-compatible systems.

Translating this data into other terms illustrates the point more graphically:

- 18,000 interviewed companies planned to buy more than 411,000 personal computers
- 14,000 of those companies planned to buy 300,000 IBM PCs
- 1,100 of those companies planned to buy 19,000 Apples.

(Figures are rounded for illustration purposes.)

There can be little question that IBM's market position is on its way to becoming virtually unassailable. IBM's recent product and marketing announcements emphasize its aggressive stance in all segments—hardware, software, financing and servicing. And it has the resources and organization to ensure its continuing dominance. The unknown factor is the extent of "noise" (non-IBM vendor sales) they will consider acceptable going into the 1990s. The ultimate cost, if IBM's market dominance is not challenged, will be limited technological innovation and limited market selection. Without viable competitive alternatives, end users will suffer

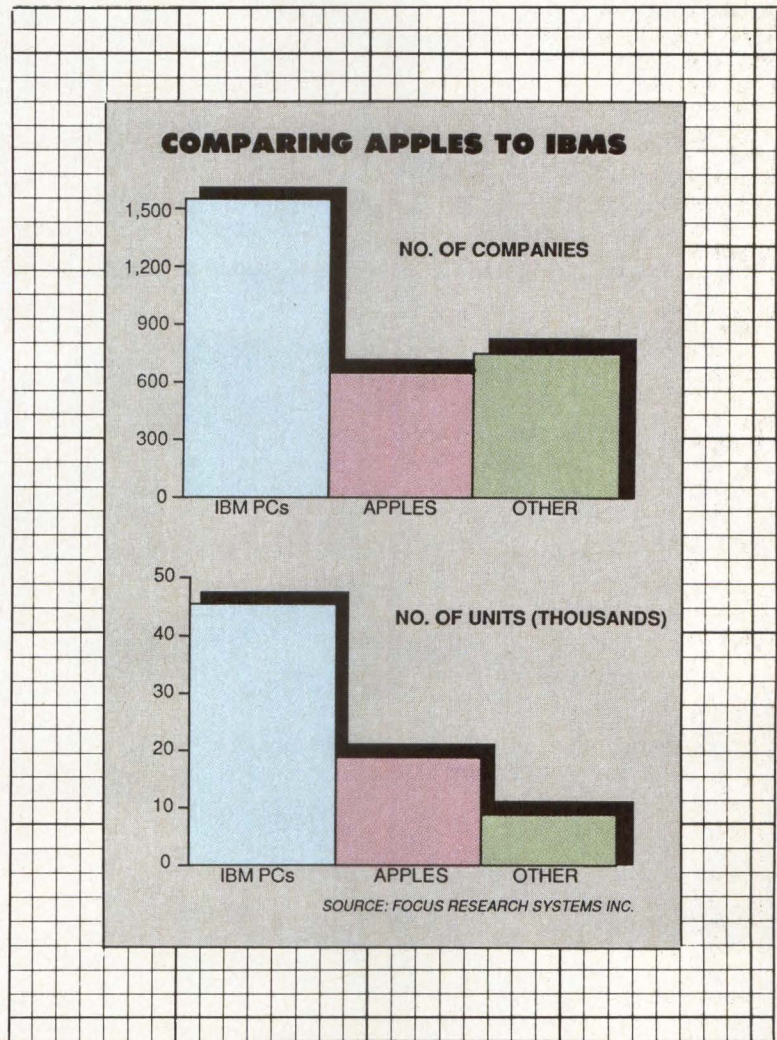

those consequences.

It is evident that the influences on the marketplace portend continuing consolidation and more bankruptcies of manufacturers and resellers. Successful companies will be those that address specific niches with good products and better marketing programs. □

Gene R. Talsky is president of Professional Marketing Management Inc. (PROMARK), Old Lyme, Conn., and is one of *Mini-Micro Systems'* contributing editors. PROMARK provides strategic, business and marketing-planning services to computer industry companies. Talsky has served in management positions with IBM Corp., Computer Sciences Corp. and Informatics General.

Among interviewed companies that have Apple personal computers, about 1,550 plan to purchase IBM PCs, while fewer than 700 plan to buy more Apples (top). In terms of number of units, IBM wins by a 2.5-1 ratio (bottom).

Interest Quotient (Circle One)
High 462 Medium 463 Low 464

UNIFY CORPORATION

UNIFY CORPORATION

RELATIONAL DATA BASE MANAGEMENT SYSTEM REFERENCE MANUAL

RELATIONAL DATA BASE MANAGEMENT SYSTEM

[ysmenu]

- 1. Schema Maintenance
- 2. Schema Listing
- 3. Create Data Base
- 4. SFORN Menu
- 5. ENTER Screen Registration
- 6. SQL - Query/DML Language
- 7. SQL Screen Registration
- 8. Listing Processor

SELECTION: █

UNIFY SYSTEM
17 SEP 1984 - 10:01
System Menu

- 9. Data Base Test Driver
- 10. MENUH Screen Menu
- 11. MENUH Report Menu
- 12. Reconfigure Data Base
- 13. Write Data Base Backup
- 14. Read Data Base Backup
- 15. Data Base Maintenance Menu

[student]
[I]NQUIRE UNIFY SYSTEM
25 Aug 1985 - 18:45
Student Registration Form

Invoice Number: 458

Last Name: Gordon First Name: Richard

Company: Silicon Design Labs
: 5550 Industrial Hwy
: Basking Ridge NJ 07890
: (201) 555-5400

Student's phone number (if different): (201) 555-5421

Class code (sgmny): CP9805 Subject: C Programming
Class fee: 995.00 Class date: 9/1/85
Deposit date: 8/15/85 Deposit amount (\$): 100.00
Payment date: 8/25/85 Payment amount (\$): 895.00

Current: 1

[student]
[I]NQUIRE UNIFY SYSTEM
25 Aug 1985 - 18:45
Student Registration Form

REPORT	TO:	SCREEN	PRINT	FILE	FILENAME
1. Student Registration Listing	[x]	[]	[x]	--	listing
2. Student Billing	[]	[]	[]		
3. Billing Summary	[]	[]	[]		

REPORT #: 1

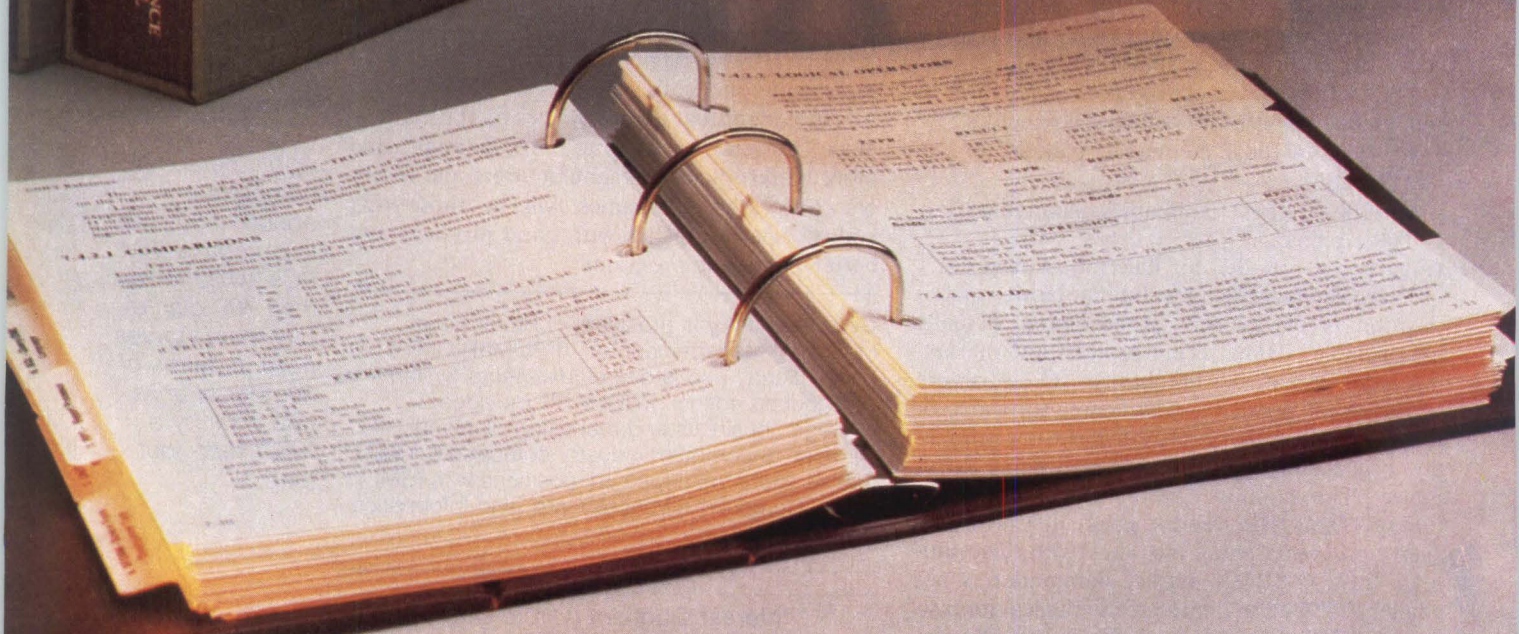

UNIFY. THE MIGHTY EASY DBMS.

UNIFY isn't only the fastest and most powerful of all UNIX*-based data base management systems—it's also one of the simplest to use. Which is why some 75 percent of those who see our manuals and buy a DBMS, buy UNIFY.

UNIFY guides the nonprogrammer through data base development with minimal steps, comprehensive menus, on-line HELP, elementary Query By Forms capability, and clear documentation.

UNIFY expedites applications development for users of all skill levels with features like PAINT, for effortless forms design; SQL, the powerful, English-like query language; and a menu-handler that lets you quickly compile screens, queries and reports into menus customized to each user.

And for the skilled programmer, UNIFY offers the most extensive host language interface, for limitless flexibility when you need it.

All of which makes it mighty easy to see why UNIFY has been selected by more computer manufacturers than any other UNIX-based DBMS.

Judge for yourself. Send for our demo kit—disks, tutorial and reference manuals, all for only \$150—that shows you how to build virtually any application. Contact UNIFY, 4000 Kruse Way Place, Lake Oswego, OR 97034, 503/635-6265.



CIRCLE NO. 47 ON INQUIRY CARD

UNIFY®
THE PREFERRED DBMS.



Our Low-Cost Voice Data Entry Peripheral Could Double Your Computer System's Productivity

Verbox voice data entry has improved the speed and accuracy of data entry operations for companies across the country. We're helping firms in material handling, inventory control, inspection, test and other applications save thousands of dollars in time and labor costs, often resulting in productivity gains of 100% and more. Now *you* can offer this proven technology in a new, low-cost voice data entry peripheral—the Verbox Series 4000 Voice Recognizer.

Integrating seamlessly with your own system, the Series 4000 Voice Recognizer adds simultaneous voice input to keyboard data entry for virtually any mainframe, mini, micro or personal computer. It loads voice patterns and applications vocabularies

directly from your host system, or from its own reusable CMOS voice cartridges. Users simply drop their own cartridges into the Series 4000 Voice Recognizer console and it instantly responds to verbal commands despite accent, dialect, or interference from loud background noise.

Simple software tools let you create custom vocabularies.

With our Series 4000 Voice Planner™ software, you can program vocabularies for any customer application. Voice Planner software runs on IBM® PC, PC compatible, and DEC VAX™ systems, and is readily adaptable to other computing environments.

True continuous speech recognition: the key to your success.

With Verbox, the user inputs data in a natural voice, so there's no risk of fatigue or irritation caused by the staccato diction that other products require. And while others may claim it, only Verbox's patented continuous speech recognition achieves this natural man/machine interface without sacrificing accuracy or vocabulary size.

For details on the Series 4000 or our OEM/VAR programs, call toll-free 1-800-343-4458. In Mass., call (617) 275-5160. Or write on company letterhead and ask for a free video tape of voice applications. Verbox, Two Oak Park, Bedford, MA 01730.

Verbox

A DIVISION OF EXON ENTERPRISES

Voice Planner is a trademark of Verbox. IBM is a registered trademark of International Business Machines Corp. VAX is a trademark of Digital Equipment Corp.

CIRCLE NO. 48 ON INQUIRY CARD

DEMAND, NEW PLAYERS BOOST LAN MARKET

The LAN marketplace shakeout begins
as the telecommunications giants
make their moves

David Lytel

Until recently, the problem with local area networks was finding one that would handle local data-communications needs. Now the problem is selecting one from the competing solutions. Just three years ago, there were few choices; today, there is a bewildering array.

Gone are the "media wars" that characterized the LAN market's early years—not that the relative merits of twisted pair vs. coaxial cable vs. fiber optics have been argued to their limits. But currently the conflict, for the most part, concerns real products rather than design philosophies. The same is true of the debate over standards. The argument goes on, but the viable standards will be sorted out by the marketplace, not by committees.

The premier standard is Ethernet (IEEE 802.3), pioneered by Digital Equipment Corp., Intel Corp. and Xerox Corp., which were joined by early vendors such as Interlan Inc., 3Com Corp. and Ungermann-Bass Inc. The token-passing bus (IEEE 802.4), brought out by Concord Data Systems Inc., is on its way to becoming the factory-LAN standard. Meanwhile, the token-passing ring (IEEE 802.5) was made famous by last year's IBM Corp. non-announcement—that its general-purpose LAN based on this standard would not be ready for as long as two years (see "Emerging standards trigger \$3B LAN market," *MMS Communications Digest*, February 15, Page 59).

One of the few things LAN market research experts agree on is that the market is growing at a healthy rate. Dataquest Inc., the San Jose,

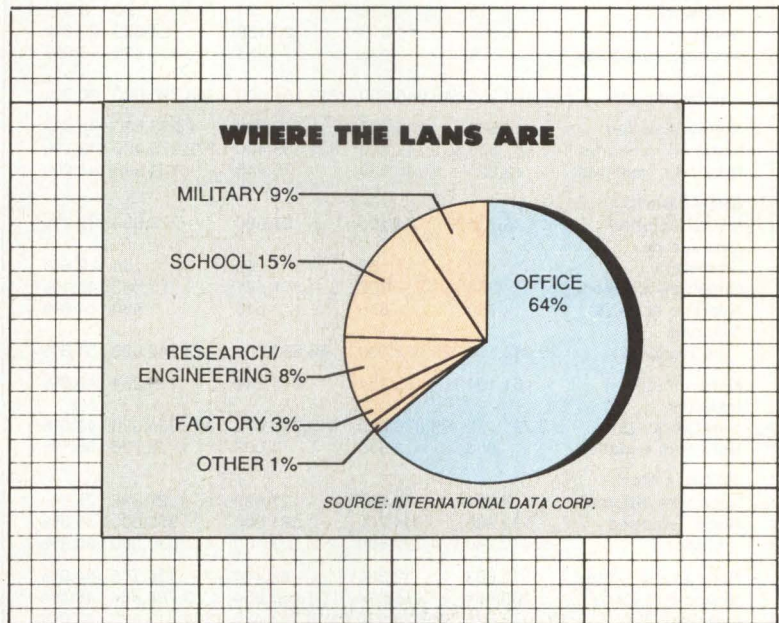

Calif., research company, predicts that the annual growth rate measured in number of units shipped will be around 65 percent from 1984 to 1988. Growth in dollars, according to Dataquest, will be up 46 percent over the same period, the difference being due to the lower cost of LAN components in the future. In real numbers, that represents an installed base of 587,000 components in 1984—including terminals, printers, personal computers, gateways and workstations—and almost 5.5 million connections by 1988.

The LAN market divides into three segments: proprietary LANs that leverage an installed base

The majority of LANs are installed in office environments. The segmentation percentages for baseband and broadband networks are approximately equal.

STATE-OF-THE-MARKET REPORT:
LOCAL AREA NETWORKS

of office equipment, such as DEC's DECNet, ARC from Datapoint Corp. and Wangnet from Wang Laboratories Inc.; general-purpose LANs, such as those from Interlan, Ungermann-Bass and Sytek Inc.; and LANs geared to the growing number of microcomputers.

The LAN market is "poised for takeoff," say analysts. They expect the total value of installed LANs to approach \$2 billion by 1988.

A great deal of attention has been focused on LANs for personal computers, due to the significant battle between companies specializing in this part of the market. Companies such as 3Com, Corvus Systems Inc., Nestar Systems Inc., Novell Inc. and Orchid Technology Inc. have been the early leaders of this segment. In the last year, however, several significant developments have taken place that may threaten their lead.

PC LANs booming

"The most significant introduction in the LAN marketplace in the last year was IBM's PC Network," says Sherry Geddes, director of communications systems for market research company Strategic Inc., Cupertino, Calif. PC Network is produced by Sytek on an OEM basis with IBM. The PC Network is a broadband network for IBM PCs that moves data over a coaxial cable at 2M bits per second (bps). Although the hardware was due in the second quarter of 1985, some close observers are saying that the software won't be ready until later this year.

Geddes says, "The most significant impact of PC Network is that the software interface is at the session level. The software developer doesn't have to worry about the network aspects of it. Until now, they had to worry about all ISO [International Standards Organization] intermediate levels."

Although the PC Network is a blow to LAN hardware interconnectivity—it isn't consistent with Ethernet—the new IBM product is a boon to the development of LAN software standards. IBM's PC Network virtually assures the lightning-fast acceptance of Microsoft Corp.'s Networks 1.0 as a de facto networking software standard. Networks 1.0 is a layer of the broadly accepted MS-DOS operating system, and Microsoft says that any program written for the new MS-DOS 3.1 will run under IBM's PC-DOS 3.1. PC-DOS 3.1 will support IBM's equivalent to Network 1.0, the PC Network program. Because Networks 1.0 is hardware-independent, third-party software developers now have a standard for which to write, which is certain to overcome one of the key obstacles to LAN growth—lack of application software.

Novell's network software was an early attempt at an industry-wide standard, according to Maureen Fleming of research company International Resource Development (IRD), Norwalk, Conn. As Fleming puts it, "Novell's network software is a better product. But Novell just doesn't have the market clout Microsoft does." Analyst Dave Terry of the Boston consultancy

LANs BOTH NEAR AND FAR: HOW WORLDWIDE MARKET GROWTH WILL LOOK (1982-1988)					
	1982	1984	1986	1988	ACG
BASEBAND					
Nodes shipped	105,570	300,300	483,800	730,000	35.4%
Average per network	18	20	24	30	9.5%
Networks shipped	5,865	15,015	20,158	24,333	23.6%
Average nodes (\$)	525	485	453	423	-3.5%
Shipped networks (\$)	55,424,250	145,645,500	219,161,400	308,790,000	30.6%
Nodes installed	244,500	775,830	1,643,630	2,973,630	48.3%
Installed networks	140,587,500	401,748,000	801,389,400	1,372,979,400	43.2%
Networks installed	12,225	40,830	78,443	124,998	43.2%
BROADBAND					
Nodes shipped	26,718	44,400	98,000	228,000	37.2%
Average per network	73	85	68	64	-2.8%
Networks shipped	366	522	1,441	3,563	41.1%
Average node (\$)	750	655	616	580	-4.0%
Shipped networks (\$)	20,038,500	29,082,000	60,368,000	132,240,000	31.6%
Nodes installed	61,194	135,234	315,234	755,234	49.0%
Installed networks (\$)	50,791,020	99,880,020	212,318,020	471,334,020	42.6%
Networks installed	658	1,560	4,002	10,776	56.1%
TOTAL LANs					
Networks shipped	6,231	15,537	21,600	27,896	25.1%
Nodes shipped	132,288	344,700	581,800	958,000	35.8%
shipped	75,462,750	174,727,500	279,529,400	441,030,000	30.9%
Networks installed	12,883	42,390	82,444	135,775	44.0%
Nodes installed	305,694	911,064	1,958,864	3,728,864	48.4%
Installed (\$)	191,378,520	501,628,020	1,013,707,420	1,844,313,420	43.0%
Notes					
1. Number of nodes shipped x average number of nodes per network = number of networks shipped					
2. Number of nodes shipped x average cost per node = dollar value of networks shipped					
3. Number of nodes shipped plus prior year nodes installed = number current year nodes installed					
4. Dollar value of networks shipped plus dollar value of prior year networks installed = current year dollar value of networks installed					
5. Nodes are physical connections and do not account for connected devices.					
6. ACG: Annual compound growth					
Source: International Data Corp.					

We're not just talking about fifth generation parallel computers, we're delivering them.

We're Flexible Computer Corporation and we've developed the Flex/32 Multicomputer. The fifth generation massively parallel computer. The computer that everyone predicted would be the next major step for the computer industry. The Flex/32 provides the only multi-computing environment; parallel hardware with concurrent software.

The Flex/32 offers you a whole new generation of capabilities. And that's not just a lot of talk.

For more information on the Flex/32, fifth generation computer and what it can do for you, call or write Flexible Computer Corporation, 1801 Royal Lane Bldg. 8, Dallas, Texas 75229, 214/869-1234.

APPLICATIONS

Multi-Target Radar/Sonar
Flight/Combat/Weapon Simulation
Tests Systems
Command Control and Communications
Signal/Image Processing
Artificial Intelligence/Expert Systems

PARALLEL HARDWARE

Multiple Super Mini Computers
Multiple Memories
Multiple Data Paths
Multiple Instruction Paths
Multiple VMEbus I/O Paths
Multiple Built-In-Test

CONCURRENT SOFTWARE

Concurrent C
Concurrent Fortran
Ada
Unix V
Real-Time O/S
Concurrency Simulator

Flexible Computer Corporation

UNIX V is a trademark of AT&T Bell Laboratories.
Ada is a trademark of the U.S. Government.
Flex/32-Concurrent C and Concurrent Fortran are
trademarks of Flexible Computer Corporation.

Expand your network's horizon.

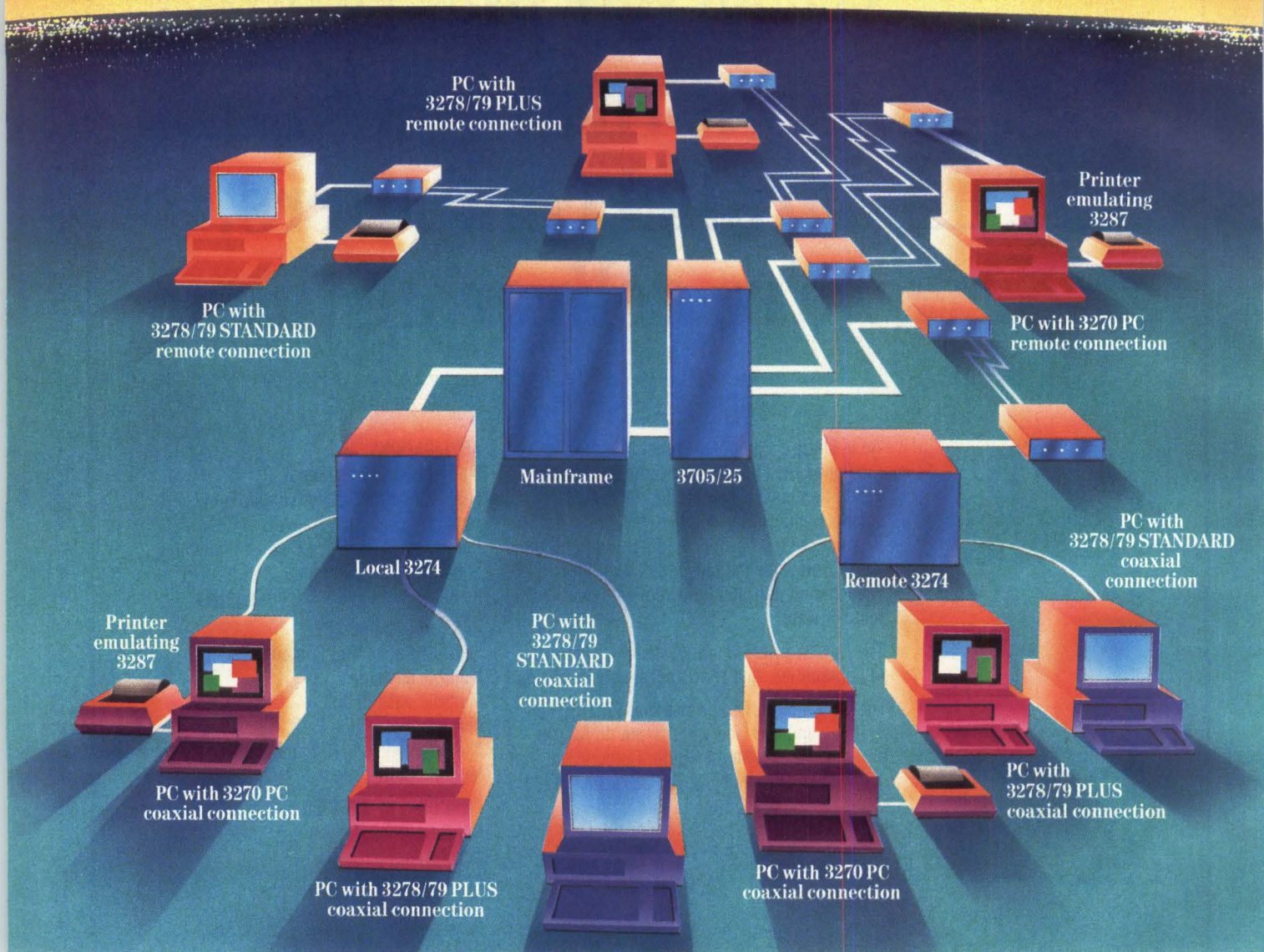

Functionality. Compatibility. Connectivity. Those are the requirements to effectively integrate PCs into your network. That's why CXI developed the CONNECTWARE™ 3270 Series.

Now you can emulate a 3270 PC, a 3278/79 terminal or a 3287 printer. You can attach your PC using coaxial cable to a 3274/76 controller, or via a synchronous modem emulating a 3274.

CXI even provides a uniform application program interface (API) across all of its products and also provides, on selected products,

either the IRMA™ or IBM® 3270 PC API.

And you can have a consistent keyboard interface, screen presentation, windowing capability and file transfer software to meet your unique requirements.

For information about our CONNECTWARE™ 3270 Series of micro-to-mainframe solutions, call us at 800/221-6402. In California, call 415/424-0700. Or write CXI, Inc., 3606 West Bayshore Road, Palo Alto, CA 94303 TELEX 821945.

We don't have all the answers, just more of them.



CONNECTWARE is a trademark of CXI, Inc. IBM is a registered trademark of International Business Machines Corp. IRMA is a trademark of Digital Communications Associates, Inc. © 1985, CXI, Inc.

CIRCLE NO. 50 ON INQUIRY CARD

STATE-OF-THE-MARKET REPORT: LOCAL AREA NETWORKS

the Yankee Group agrees: "The PC Network doesn't provide the performance of Netware, but it sets a standard for the LAN world. Other than PC Networks, MS Networks, Novell's Netware and EtherSeries, there won't be any other network software in a year's time."

The announcement of IBM's PC Network is significant in that it represents the first of the behemoths of computing and telephony entering the enormously lucrative local data-communications market. The early LAN market leaders might seem to be well-established, but, as Ken Thurber, president of Minneapolis networking group Architecture Technology, says, "I don't think those companies are so well-established in comparison with the large companies. In the future, the large companies will be at an advantage." According to Thurber, the signs of stress on the early entrants will begin to show in early 1986, when IBM's PC Network hits the market.

The actions of such superpowers as IBM, AT&T Co. and Northern Telecom Inc. will be tremendously significant, especially when they join forces with powerful corporate allies. The

day of reckoning for the LAN vendors that have been crowding the marketplace might not be too far away.

According to IRD's Fleming, Northern Telecom's announcement of its Meridian Line, a twisted-pair private branch exchange with a closely integrated local network, was the most significant development in the LAN marketplace last year because "it is indicative of what other PBX manufacturers, like AT&T, will do."

Meridian allows data communications at 2.5M bps, which begins to approach the 10M bps of Ethernet or other data-intensive communications channels. Meridian's local network is based on a double-bus networking scheme—a 40M-bps bus for information flow and a 100M-bps controller. A central processor polls all nodes for voice or data packets. Because of a proprietary chip in each terminal, Northern's new voice/data terminals can access the network at speeds to 2.56M bps. The chip is placed in the boards of other devices, such as the IBM PC. The Meridian line includes gateways to Computer and Communication Industry's X.25, IBM's Systems Net-

AT&T has two products currently in the LAN market and one in the wings that is certain to have a major impact.

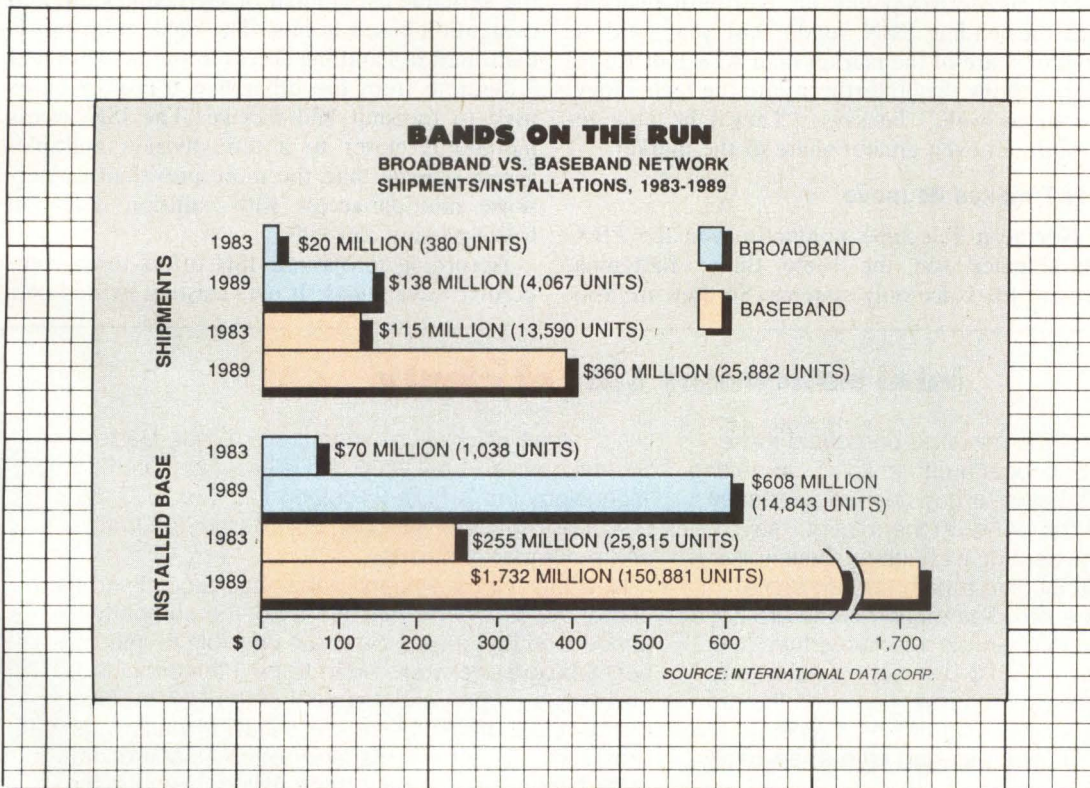

Shipments of broadband networks are expected to increase at a 31.6 percent annual growth rate between 1983 and 1989. Shipments of baseband networks over the same time period are expected to increase

at 30.6 percent (top of chart). The installed base of broadband networks is expected to increase at 42.6 percent, while baseband installations are expected to grow at 43.2 percent (bottom of chart).

'The early market leaders like Ungermann-Bass and Sytek will make excellent acquisition candidates.'

work Architecture and other protocols. Northern does not have interfaces to Ethernet or proprietary networks but says it is working on them. "Until this introduction," says Fleming, "twisted pair was too slow. But this is a way to transmit at high speed without doing any wall-bashing."

George Mellow of Advanced Resources Development, El Dorado, Calif., echoes Fleming's analysis. "Meridian is a market-setting product," he says. "It's a LAN with voice capabilities, but they're secondary to data. It's primarily for small groups of users [five to 35 data and 100 voice users simultaneously]. It's an exciting product that brings together more voice-and-data features than ever before."

Meridian isn't alone in the market, however. Intecom Inc. for example, has been a pioneer in developing high-speed internal packet switching. Its Integrated Business Exchange (IBX) LAN-mark combines the functions of a PBX with Ethernet and can provide data communications as fast as 10M bps over standard twisted-pair telephone wire.

Still, as Mellow points out, Northern Telecom was the leading PBX vendor last year, with a greater share of the market than AT&T or Rolm Corp. "Now they [Northern] are the technology leader as well," he says. "They'll be able to capture an even greater share of the market."

AT&T makes its move

Northern Telecom's competitors in the PBX marketplace see the same thing: flattening growth for voice-only systems. So they are also

on the move. AT&T currently has two products for the LAN market, and one in the wings that is certain to have a major impact.

AT&T has a personal computer network for its 3B line of microcomputers, which are built by 3Com. But much more important is AT&T's introduction eight months ago of a general-purpose, wide area network called the Information Systems Network (ISN). ISN can move data at 8.64M bps and is very similar to the announced, but not yet introduced, IBM WAN designed around the token-ring architecture. ISN is a value-added version of AT&T's Databit virtual circuit switch which it sells to local phone companies.

Neal Vasant, product marketing manager of large business systems for AT&T Information Systems, New York, calls ISN a "total solution—a packet-switching network which is part of a premises-wide data network for 50 users and up." It is a centrally controlled, star-based system using twisted-pair wiring.

ISN uses three very short bus-type local networks inside a central controller. They allow for the veritable assignment of high bandwidth and contention-based access. The contention bus is dedicated to handling access to the network and is discrete from the other two transport buses used to transmit and receive. The ISN access method is closer to a time-division multiple-access scheme than the more prevalent carrier-sense multiple-access with collision detection token-passing methods.

According to Vasant, ISN offers three competitive advantages. It uses existing twisted-pair

Intel announces LAN of plenty

In the past, one of the mistakes one could make with the selection of a local area network was getting stranded—not being able to buy needed interfaces. "When you look at the LANs on the market," says Stuart Wecker, president of Technology Concepts, Sudbury, Mass., "they give a path and do some switching. Some are broadband, and some are baseband. They start to differ in the interfaces they offer, but, if one guy offers a 3270 terminal emulator today, the next guy will offer it tomorrow." He sees the growing number of interfaces to various host types (X.25, Systems Network Architecture and others) as "really significant."

For example, Novell Inc., Orem, Utah, is solidly in the business of connecting departmental LANs into company-wide systems. Its NetWare connects Corvus Systems Inc.'s Omninet, Davong Systems Inc.'s Multi-

link, Gateway Communication Inc.'s G-Net, Nestar Systems Inc.'s PLAN 2000, Novell's S-Net, Orchid Technology Inc.'s PCnet, Proteon Inc.'s proNET, Standard Microsystems' ARCnet, 3Com Corp.'s Etherlink and a number of others.

Now Intel Corp., Phoenix, Ariz., has proclaimed the end of the stranded LAN. In March, the company announced that it would make it possible to interconnect whatever networks need to be interconnected. This was a ringing endorsement of the LAN's place in the computer marketplace. Says David House, vice president and general manager of Intel's Microcomputer Group, "The impact that LANs will have in the future is only now beginning to be understood. One thing is clear to us: Soon, LAN devices will have the same strategic importance to Intel that microprocessors do today."

Tally Technology Works Great On Paper.

No other 600 LPM line printer is engineered like a Tally. So nothing else performs like a Tally. Or prints like a Tally.

- ▶ The proof's on paper.
- ▶ Everything from high volume report printing to high resolution graphics. And a quality, fully formed look for correspondence.
- ▶ All in one machine. All the result of Tally technology. Like the MT660's innovative hammer bank and linear "shuttle" system that perfectly positions every impression and prints with uniform impact.

▶ There's also more than enough resident intelligence and paper handling versatility to make programming shortcuts easy. For operator convenience, status reports are illuminated on a scrolling display. And it's quiet enough—at 60 dBa—to go almost unnoticed.

▶ Precision printing at its reliable and repeatable best. From Mannesmann Tally.

▶ For more information on the world's most advanced, most productive line printers call now: (206) 251-5524.

**MANNESMANN
TALLY**

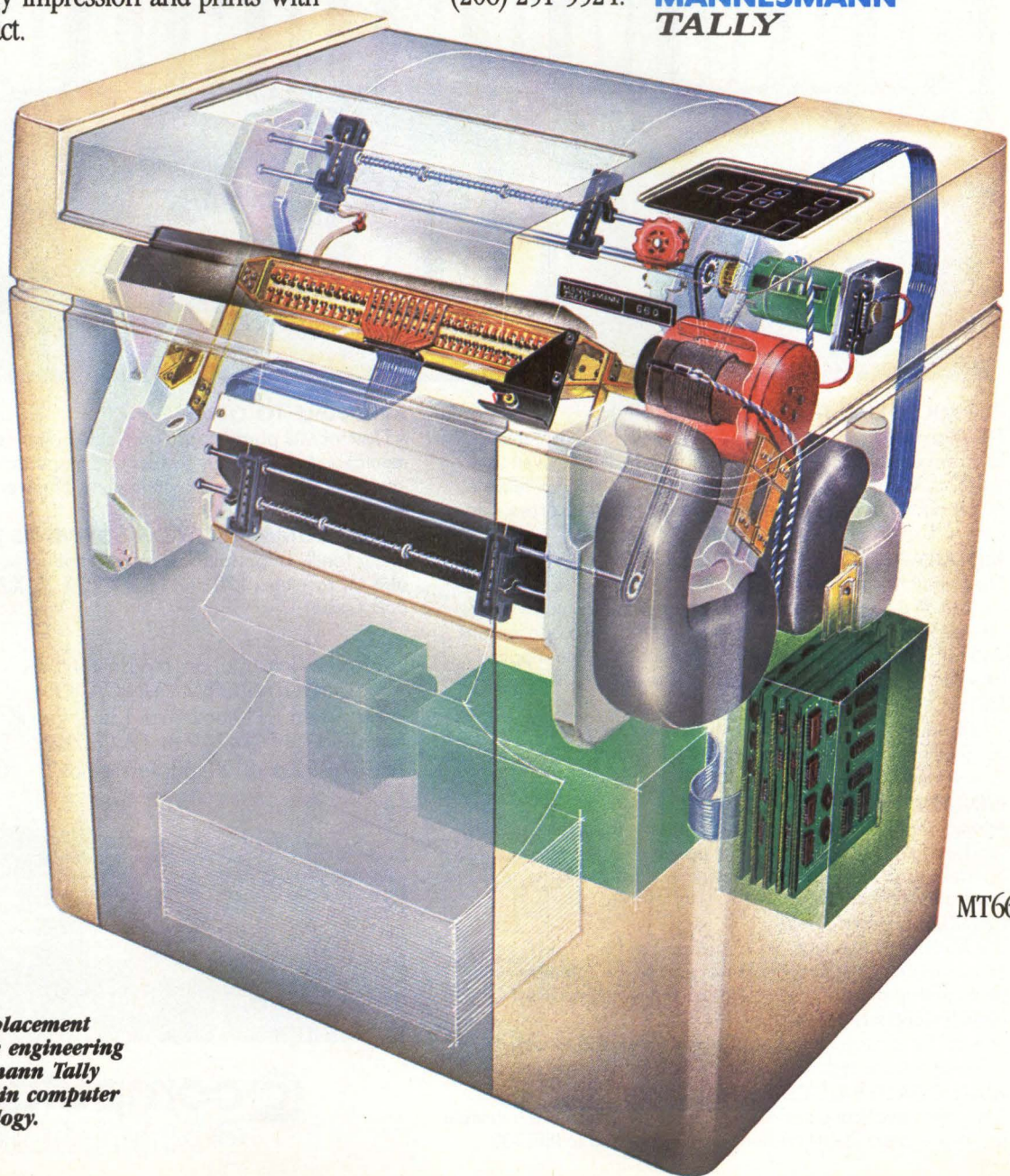

*Precision dot placement
and innovative engineering
make Mannesmann Tally
today's leader in computer
printer technology.*

CIRCLE NO. 51 ON INQUIRY CARD

THE SOURCE OF MICRO-MAINFRAME COMMUNICATION SOURCE

THE MICROEMU FAMILY:

The MicroEMU family of micro-mainframe communication software products consists of i.a. Micro7814, (Honeywell VIP7814), Micro30 (Sperry UTS30), Micro3780 (IBM 3780), etc. All products are complete implementations of the corresponding communication protocols.

MODULAR, PROTABLE AND FLEXIBLE:

The MicroEMU source is written in "C" and the crucial requirement for the installation of the software is a C-compiler. For operating systems which do not support real-time applications and for systems without OS, an RT-monitor may be supplied together with the communication software.

NETWORK SUPPORT:

The products within the MicroEMU family are available with optional network support for X.21 (CSDN), and V.22bis auto-dial auto-answer modem (PSTN).

WINDOWING:

All MicroEMU products are implementable to systems utilizing windowing mechanisms making it possible for the terminal operator to communicate with more than one mainframe application at the time.

PROCESSOR SHARING:

The MicroEMU products are developed as four tasks processes making it possible to run part of the software on a front-end processor to off-load the main processor.

IMPLEMENTATION AIDS:

Testtool for protocol emulations and on-line monitoring are included to ease system integration and field diagnosing.

HIGH QUALITY DOCUMENTATION:

Complete specification and design documentation are available for all products. Quality Assurance is according to IEEE730.

AVAILABLE TO OEMs:

All MicroEMU products are available in source with full documentation to system integrators and manufacturers of PCs, intelligent terminals, micro-computers, black-boxes, and plug-in cards.

OTHER COMMUNICATION SOFTWARE PRODUCTS:

In our family of portable communication software source are also MicroTeletex T.70 and T.62, X.21, X.25, X.75, X.214, X.224 and X.430.

For further information, please contact:
A.S COMPUTAS COMMUNICATION
Veritasveien 1, PO box 390, 1322 Hoevik, Norway
Telephone (47-2) 47 79 31, FAX (47-2) 47 98 71,
Telex 76192 or 8100460, Teletex 2421 - 100460

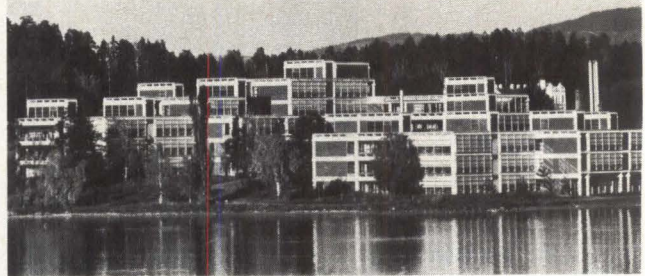

© computas
communication

STATE-OF-THE-MARKET REPORT: **LOCAL AREA NETWORKS**

wiring but "allows selected upgrading to fiber optics anywhere in the system." Vasant also says his product "can start with a low number of users and network to thousands of users without worrying about gateways."

ISN has two other significant market advantages. It could be the local node on AT&T's widely anticipated but yet-to-be-announced public packet-switching network. Or, it could be used in the construction of a private packet-switched network. And ISN is available now, unlike IBM's token-ring, general-purpose LAN.

But AT&T also has a product based upon the emerging Starlan standard. Terry of the Yankee Group believes that AT&T will announce this product in the second quarter of this year, and he predicts that by the end of 1985 about a half a dozen companies will be offering Starlan-based products (802.3 is also considered another alternative to Ethernet) (see "Cheapernet makes local area networking more affordable," MMS, January, Page 74).

Starlan is a slow, less expensive LAN for small areas. Intel introduced its 82588 chip for Starlan last December. Starlan runs at 2M bps—much slower than Ethernet's 10M bps, but the cost per connection for Ethernet is almost \$1,000, while for Starlan, it is \$250.

This is not good news for Corvus. With an installed base of more than 50,000 nodes worldwide, Corvus considers its Omninet to be the de facto low-speed LAN standard. Omninet is a 1M-bps network using an RS422 twisted-pair-cable bus that allows up to 64 nodes on a 1,219-meter segment without repeaters. After 17 quarters of increased earnings, Corvus fell into the red last fiscal year, losing \$10.6 million on \$50.5 million in revenues. Although the loss was generally due to slow sales of its hard disks and other storage devices, the thought of competing with AT&T and another dozen or more players in this segment of the market cannot be encouraging for Corvus.

"My guess is that AT&T is making hay right now, although I can't prove that," says Architecture Technology's Thurber. "I do not think AT&T will lose the market edge, even when IBM starts competing. I don't think AT&T has sold many ISNs, but IBM hasn't sold anything comparable."

Awaiting Big Blue's action

IBM's tentacles are so pervasive in the LAN marketplace that virtually every company has some relationship with the company, either as an ally or competitor. In addition to its interim LAN for PCs, IBM has announced its own

cabling system, a basic way of wiring a building designed to help solve cabling confusion. According to Architecture Technology's Thurber, "what they've done by announcing their cabling system is to create a market. The first phase is the wire. Then, they'll bring out the token-ring interfaces, then the communications gear. They're taking an incremental approach—solving problems on a migration path."

IBM has shrewdly built alliances with some of the leading players in the LAN and PBX marketplaces. Not only have they acquired Rolm Corp., one of the leading telephony companies, but they also have signed Sytek to produce the boards and transceivers for the PC Network.

This is a shift in Sytek's focus. Until now, it has not concentrated on microcomputer connections. But Sytek's relationship with IBM has been a magnificent boost to the smaller company's business. The communications protocol used by the IBM PC Network is Sytek's property, and Sytek licenses that protocol at its discretion. Analysts already are comparing Sytek's new position to the IBM/Microsoft relationship, which overnight changed Microsoft from a small unknown to a \$100 million industry leader, due to the contract to provide the operating system for the IBM PC.

According to industry reports, IBM also has chosen another LAN industry leader for its forthcoming token-ring networks. Although Ungermann-Bass officials do not comment, the company is widely acknowledged to be developing communications software and hardware for IBM's token ring. Ungermann-Bass is also said to be working on peripherals for the IBM token-ring network to get the jump on competitors in the IBM token-ring interface market.

Shakeout or explosion?

These OEM agreements are probably a good indication of the future for early LAN market leaders as the corporate superpowers move into data communications. Analyst Kim Myhre of International Data Corp. (IDC), Framingham, Mass., points to the OEM contracts of the market leaders—3Com's sale of its products through Xerox and Corvus' OEM agreement with NCR Corp.—as indicative of how the early leaders will find a role in the changing market environment.

Analyst Roger Sherman of Creative Strategies Research International, a San Jose, Calif., researcher, believes "the early market leaders like Ungermann-Bass and Sytek will make excellent candidates for acquisition." Eventually, Sherman believes, "survival in the shakeout of the

Perhaps it's more useful to think of LANs not so much as their own market but as value-added devices.

STATE-OF-THE-MARKET REPORT:
LOCAL AREA NETWORKS

IBM's tentacles are so pervasive in the LAN marketplace that virtually every company has some relationship with it.

market will go to the large vendors because they can offer a total solution. Once the technology becomes mature and standards are resolved, then it becomes a price-competitive market. Clearly, the large vendors are in a position to survive that kind of market."

But it is possible that the sustained growth of the LAN market will allow most of the current players to survive with some identifiable niche in the market. At least one observer expects to see the number of LAN vendors continue to grow. Jan Lewis of Infocorp, Cupertino, Calif., says, "There will still be a tremendous number of new entrants into the market. There are lots of small niches to fill, like gateways between networks and innovative modems."

Analysts frequently compare the LAN market to the microcomputer market, saying that the smaller players will be squeezed out as the larger players take over. But perhaps it's more useful to think of LANs not so much as their own market but as value-added devices. Apple Computer Inc., Cupertino, Calif., recently introduced its AppleTalk LAN for the Macintosh line to allow

sharing of its laser printer. As IDC's Myhre says, "The real product isn't the network; it's the printer. It's a terrific printer. The network is just a device to sell the printers. Corvus, too, isn't out to sell LANs; they want to sell their Winchester's. The issue is selling boxes, not networks. Networks are just vehicles to sell more boxes."

Lewis also points to AppleTalk as a market-setting product. "This is a very good vision of what will happen and what needs to happen," she says. "If Apple plays a missionary role of getting LANs into small businesses, they'll definitely help open up the market." □

David Lytel is an Ithaca, N.Y.-based free-lance journalist who has written widely on data communications and computing.

Interest Quotient (Circle One)
High 465 Medium 466 Low 467

Multi-user 68000 board manages up to 8 megabytes for instant access. \$1095.

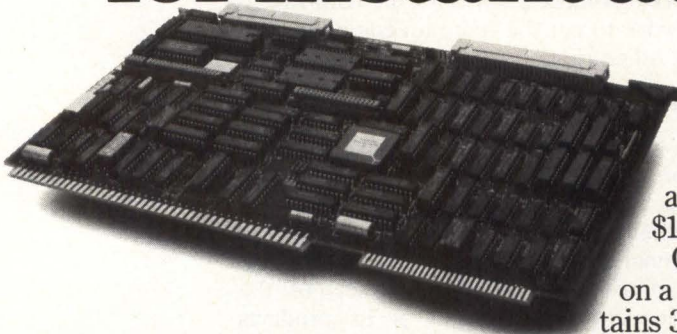

An advanced memory management unit eliminates all wait states. Lets this Multibus computer access up to 8 megabytes non-stop at 10 MHz. Lets you handle multi-user, multi-tasking, real time operations at lower cost than ever before. Because it's only \$1095 in 100 lot.

Our M68CPU computer packs amazing power on a single board. Its memory management unit contains 32 independent maps for task sizes from 4 KB to

8 MB. (Our companion boards carry all the RAM you need at 512 KB to 2 MB per board starting at \$900 in 100 lot.)

The board gives you two RS-232 serial ports, two iSBX Multimodule connectors, and two 28-pin sockets for EPROM. We give you a choice of two microprocessors, either the 68000 or 68010, and expert software support hard to find elsewhere.

All from SBE, 2400 Bisso Lane, Concord, CA 94520. TWX: 910-366-2116. Phone free 1-800-221-6458 for literature mailed today. In California call (415) 680-7722.

CIRCLE NO. 53 ON INQUIRY CARD



Computer boards and systems.

TEMPLATE.

We're offering more than precision visuals.

There's more to engineering and scientific graphics software than pretty pictures. At TEMPLATE® we build quality functionality into graphics software tools.

That makes us feel so good about our family of products that we're offering you our \$300 MICRO TEMPLATE® package free, just for seeing the rest of our show.

Surprised at our generosity? You shouldn't be. Who more than TEMPLATE is committed to providing you high-technology graphics and sensible software solutions?

Whether you're a sophisticated user, or just starting out, our product family—including TEMPLATE, 2D TEMPLATE®, CONTEMPLATE™, DIMENSION-GKS™, MICRO TEMPLATE and a variety of options—is designed to address your specific problems. And solve them.

TEMPLATE people know this. They include specialists in dedicated device driver development and customer support. Hot-Line accessible and always professional. Together they provide technical expertise around the world.

Isn't this the blend of product and service you've been looking for? Precisely. So contact TEMPLATE. If you qualify, we'll bring you a free MICRO TEMPLATE package—compatible with IBM PCs, ATs, XTs and TI Professionals. Then we'll remind you of all we can offer. And what our competitors can't.



TEMPLATE
THE SOFTWARE DIVISION OF MEGATEK CORPORATION

The Innovators in Graphics Software.

9645 Scranton Road, San Diego, CA 92121 619/457-5359 TWX: 910-337-1270

TEMPLATE is a Registered Trademark of Megatek Corporation. CONTEMPLATE and DIMENSION-GKS are trademarks of TEMPLATE.

CIRCLE NO. 54 ON INQUIRY CARD



Ampex's new 230 avoid discomfort where our

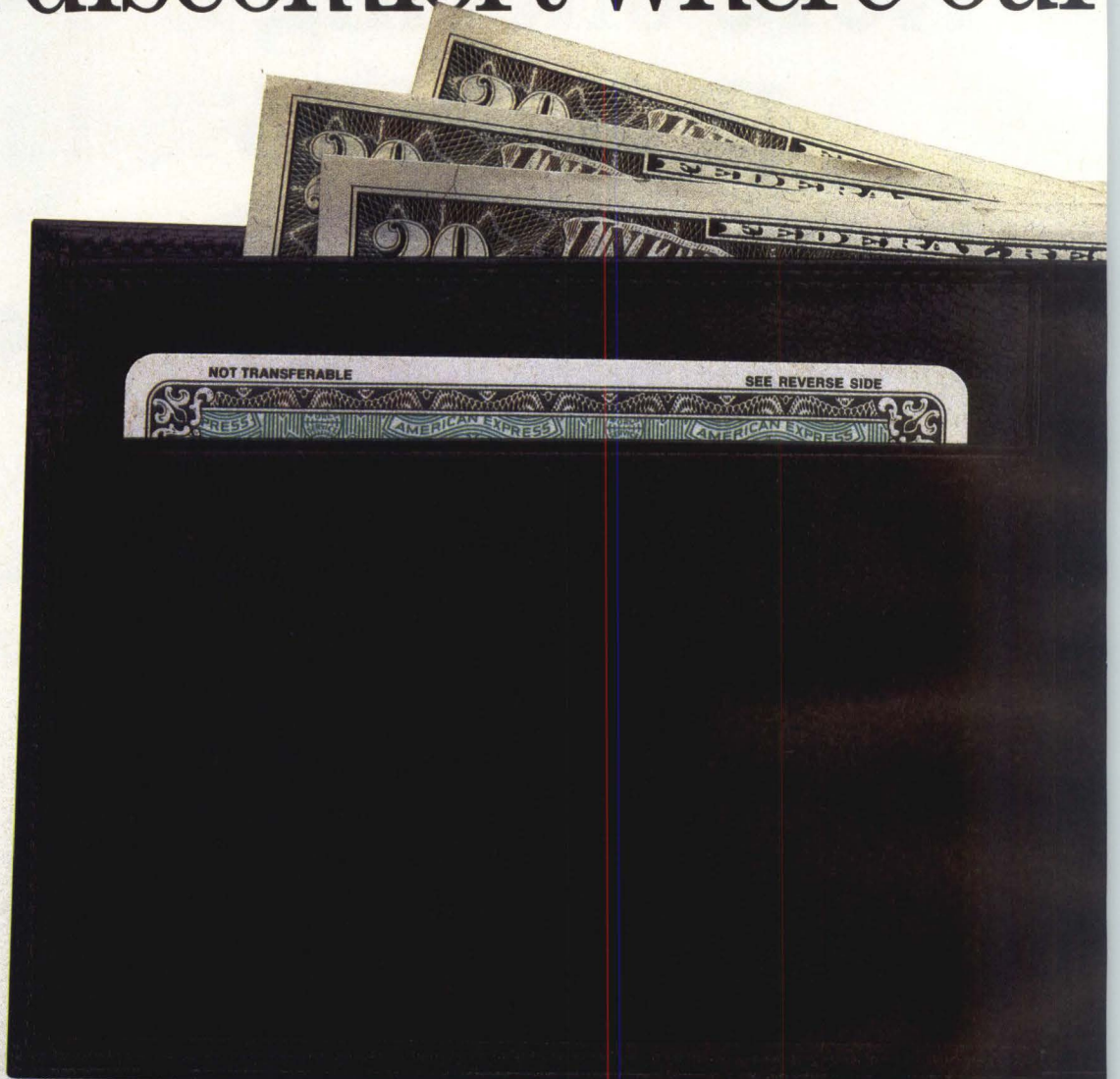

We applied ergonomics, the science of making you comfortable, to every aspect of our new Ampex 230 editing terminal.

We designed it with a 14" non-glare, tilt-and-swivel screen that's easy on your eyes. A sleek, spare shape that's compact on your desk. A low-profile, adjustable-slope, Selectric-style keyboard that's responsive to your touch.

Plus one more soothing feature:

Its price tag.

Fact is, for the money, the Ampex 230 offers quite a few features you won't find on terminals it emulates: Wyse 50, TeleVideo's 914, 924, 925 and 950*.

Check it out. You'll see a screen that's 2" bigger than TeleVideo's, an 80/132 column format instead of their 80, and 16 programmable function keys compared to 3 or 11 on TeleVideo's 914 or 950. You'll see Wyse doesn't

terminal. Designed to competition hurts you most.

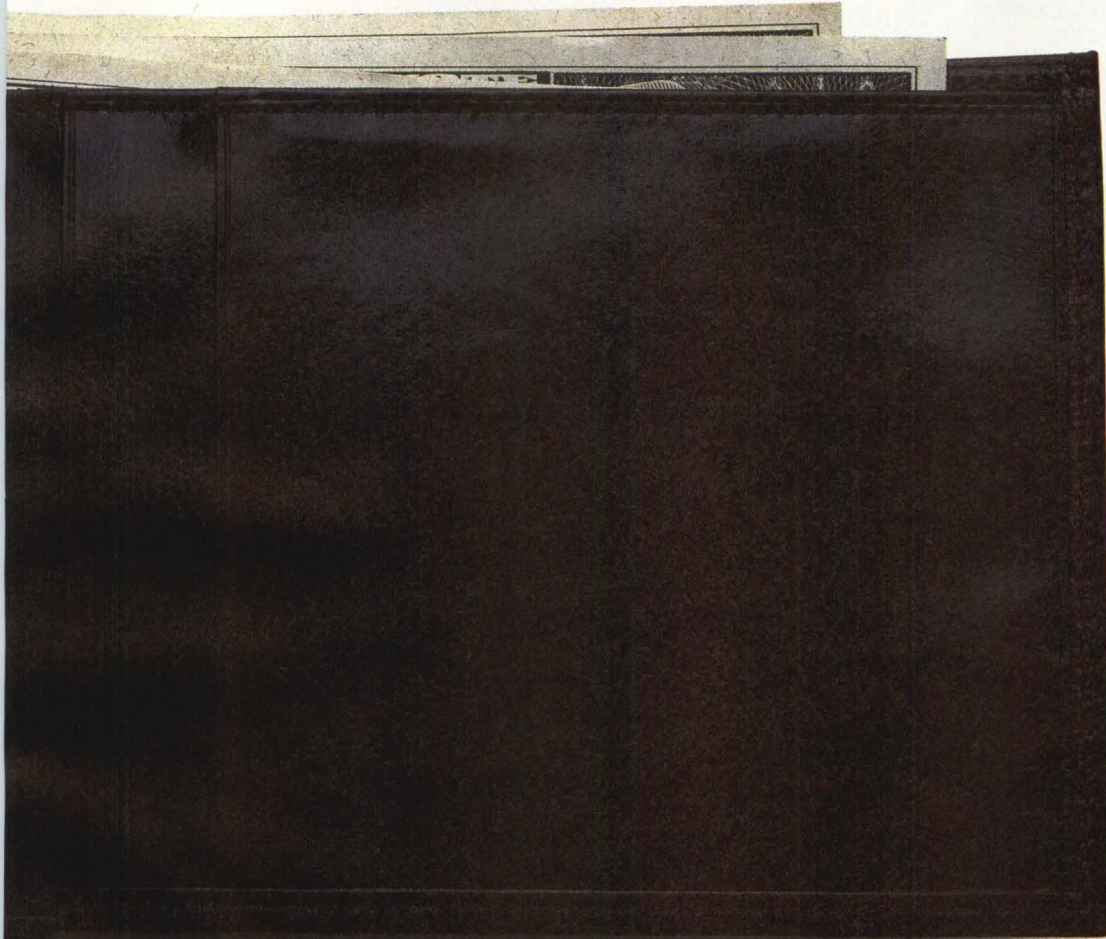

offer a standard second page of memory or non-embedded attributes. And neither one offers amber.

We do. At no extra cost.

What's more, we back our whole Ampex terminal family with worldwide service. A one-year warranty. Reliability above industry standards. Plus something else the competition can't match—our 30 years of video,



computer peripheral and manufacturing expertise. So call the Ampex Computer Products Division at (800) 621-0292 or (800) 821-9473

in California. See the terminal that makes both ergonomic and economic sense: Our new

Ampex 230. You'll find the green soothing.

Even if you choose amber.

AMPEX

Ampex Corporation • One of The Signal Companies

CIRCLE NO. 55 ON INQUIRY CARD



“LATER” IS TOO LATE.

The window of opportunity in voice applications processing is wide open.

The billion-dollar digital voice processing market is emerging now. As an aggressive PBX or computer OEM, are you ready to get your share?

You can be—if you start now by investigating the new DSC-2000 VoiceServer™ from Digital Sound Corp. It's the only available all-digital end-to-end applications processing system optimized for real-time voice capabilities. And it's got some powerful advantages going for it.

EARLY MARKET ENTRY R&D in voice processing is costly and time-consuming. But at DSC, our scientists have years of hardware and software experience in speech processing, minimizing your product development time.

And because the VoiceServer uses only industry-standard computer and telephony interfaces, integrating it into your system is easy.

PRODUCT EXCLUSIVITY You don't want another “me too” product. With the VoiceServer's Open System Architecture,™ Multibus and UNIX System V software, customization becomes simple. And our software packages for voice mail/file applications are just a starting point. Off-the-shelf software makes it easy to add concurrent voice, data and communications processing.

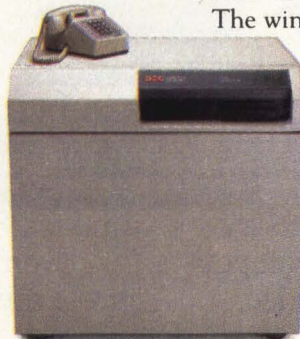

OBSOLETE PROOF DSC is already developing the next generation of digital voice applications: converting text to voice, recognizing spoken commands, and more. You can offer these enhancements to VoiceServer users as future options—without obsoleting your customer's system. Result: extended product life-cycle plus additional revenues for you.

MAXIMUM PROFITABILITY The VoiceServer costs about a fifth as much as other systems that don't do nearly as much. It delivers high-quality digitized speech at a third the bit rate of competitive products. It cost-effectively handles 200-4,000 stations.

Put all these figures together, and they spell low costs, and high profits for PBX or computer OEMs. We wouldn't want it any other way.

The window of opportunity in the digital voice applications market is wide open right now. Better call DSC and start locking in your share.

VOICESERVER™ by

DSC

Digital Sound Corporation
2030 Alameda Padre Serra
Santa Barbara, CA 93103
(805) 569-0700

Open System Architecture is a registered trademark of Digital Sound Corporation. Multibus is a registered trademark of Intel Corp. UNIX is a trademark of AT&T. ©1985 Digital Sound Corp.

CIRCLE NO. 56 ON INQUIRY CARD

MICRO SOFTWARE PROMOTES EASE OF USE

Analysts predict a healthy 63 percent annual growth rate for integrated software and a staggering 136 percent annual growth rate for environment managers

Robert H. Blissmer

Making personal computers easy to use is shaping up as one of the key marketing strategies for 1985 and beyond.

On the horizontal-market front, non-technical users are developing an interest in incorporating computers into their work, leisure and entertainment. Learning to master complex commands and wading through dense technical manuals, however, does not fit into these users' plans.

In the vertical markets, building customized application solutions to meet end-user needs is often not enough. Application software that is rich in functionality is getting so complex that success in the marketplace often lies in making that software easy to use.

What makes personal computers easy to use? The industry is addressing the question with a wide variety of software such as integrated packages, environment managers, user interfaces, programmer tool kits and operating system extensions. They offer choices ranging from pop-up menus in place of command-oriented interfaces to high-performance, graphics-based custom interfaces. According to Kim Evans, software analyst at Dataquest Inc., a San Jose, Calif., market research company, high-resolution graphics and high performance will be the two most important factors in determining the acceptance of new generations of application software.

Vast new markets will open up for systems that have rich functionality to solve complex problems and are the easiest to learn and use. Value-

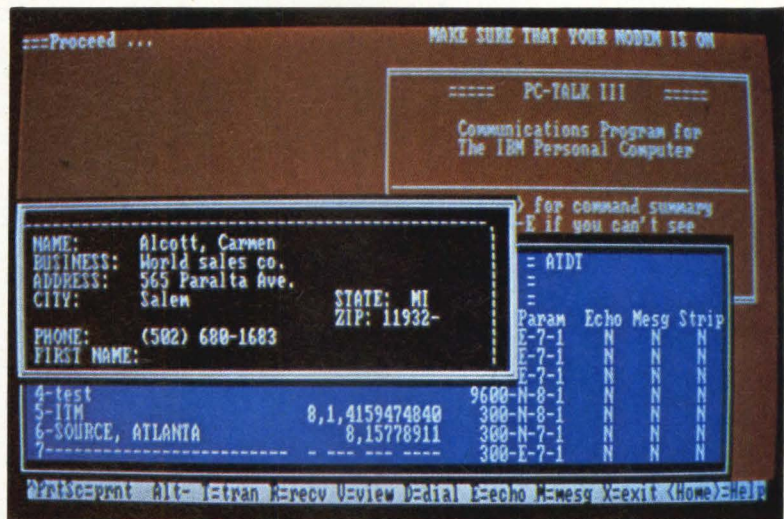

Concurrent PC-DOS displays each program in a window and allows a user to run up to four PC-DOS or CP/M application programs concurrently.

added resellers that incorporate ease of use into their products will thus gain a competitive edge over those that simply sell product and documentation.

Integrated means multiple functions

Integrated application software combines multiple functions, such as word processing, spreadsheet capabilities, database management, business graphics creation and communications, under a unified command structure so that all

STATE-OF-THE-MARKET REPORT:
PERSONAL COMPUTER SOFTWARE

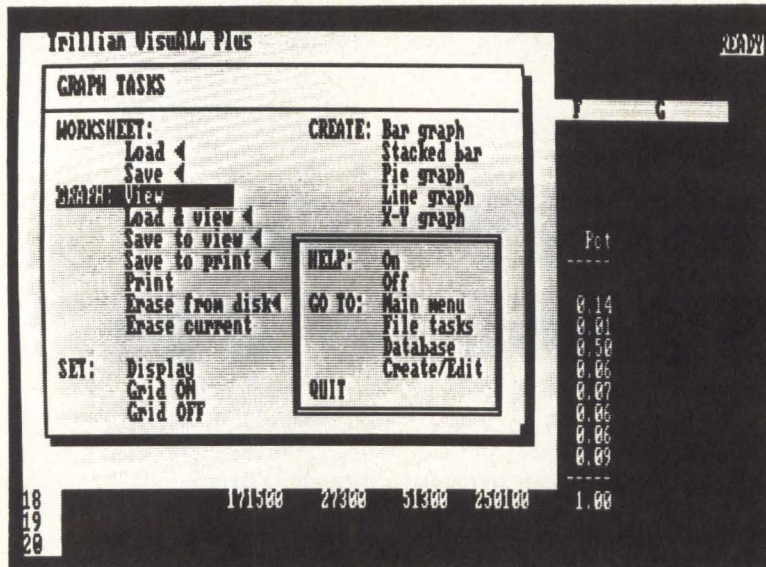

VisuALL displays a pop-up menu window that overlaps the application display. The user executes tasks by pointing to task names with cursor-control keys or a mouse.

functions are performed in a similar manner. Integration can be accomplished by a single multifunction program, such as Lotus Development Corp.'s Symphony or Ashton-Tate's Framework, or by a family of programs that share similar user interfaces, such as Software Publishing Corp.'s PFS:Series. In addition, integrated software shares data between functions and generally supports cut-and-paste operations, such as locating an address from a database, "cutting" it out and "pasting" it into a letter in word processing.

According to Ronnie Ward, executive vice president of Future Computing Inc., a Dallas market research company, "1984 was a difficult year for the multifunction program, as witnessed by the number of products that didn't make it." Ward gives the nod to family series-type integrated products, because the VAR has more options in customizing the software. VARs should note that a 1984 survey of software sales conducted by Future Computing shows that for every unit of Symphony sold through the retail channel, two units of a Software Publishing PFS product were sold. Dataquest estimates show the \$121 million market in integrated software in 1984 growing at an annual compound rate of 63.2 percent to \$1.4 billion in 1989.

Lotus' Symphony integrates word processing, spreadsheet capabilities, database management, business graphics creation and communications. It also features a command programming language for creating customized applications. Symphony uses the spreadsheet metaphor to store all data, including text. Symphony is a logical upgrade to Lotus' 1-2-3 software because it con-

tains all the features of 1-2-3 plus a word processor modeled after a popular Wang Laboratories Inc. word-processing program.

Late last year, Lotus began offering seminars for independent software developers to introduce them to Symphony's technical details. Symphony's open-ended structure allows independent software developers to develop vertical market and turnkey applications based on Symphony.

Lotus also will enter into collaborative agreements with other corporations. The result of one such agreement, a joint venture with Digital Communications Associates Inc., is a Symphony add-in that connects Symphony to the IBM Corp. 3270 display system and IBM System/34, /36 and /38 minicomputers for high-speed data transfer between the systems.

Ashton-Tate's Framework integrates word processing, spreadsheet capabilities, business graphics and database functions. Its unique feature, as its name suggests, is its use of the frame metaphor for storing information and organizing frames into an outline. A frame is different from a window in two respects. First, frames can be nested. A frame can contain as many as 32 other frames, and each nested frame can have 32 more frames. Second, frames can be linked and organized by an outline that joins frames to form a document.

'Fred' writes the software

Framework is written in a programming language called "Fred," which programmers can use to write additional software or to customize Framework for specific vertical-market applications. "Ashton-Tate has a reputation for actively working on joint-marketing ventures," says Karen Orton, OEM contract manager for Ashton-Tate of Culver City, Calif., "and is encouraging VARs and authorized resellers and marketers to build custom solutions."

Dataquest estimated 1984 sales in the integrated-software marketplace of 90,000 units for Symphony vs. 70,000 units for Framework. However, Future Computing figures that Symphony outsells Framework 4-to-1 in the retail channel.

Environment managers are programs that coordinate or supervise independent programs and that are specially designed to support the operating environment. The result is *integrating* software, which allows two or more programs to run under the same environment, as opposed to *integrated* software, which combines functions under the same user interface.

Environment managers can serve VARs in two ways: (1) as an integrating "umbrella," allowing

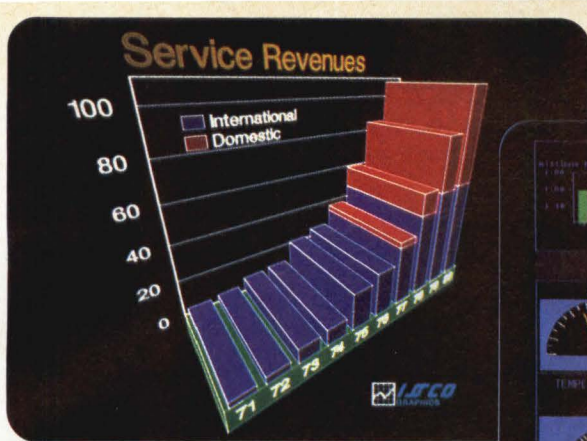

Screen images courtesy of ISSCO® Visual Intelligence Corp., PDA Engineering, and UNIRAS®, Inc.

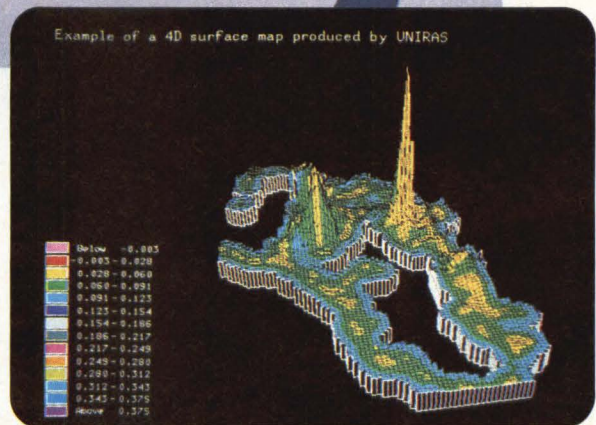
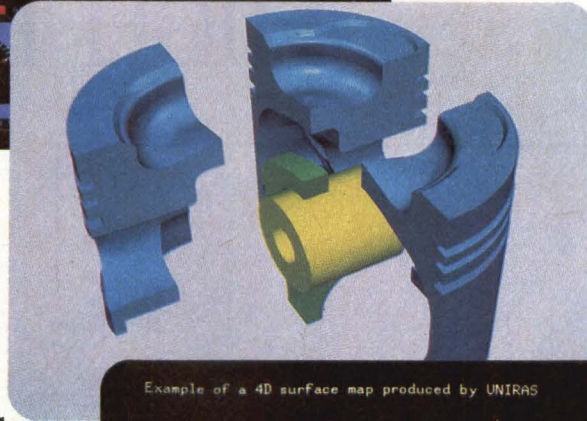
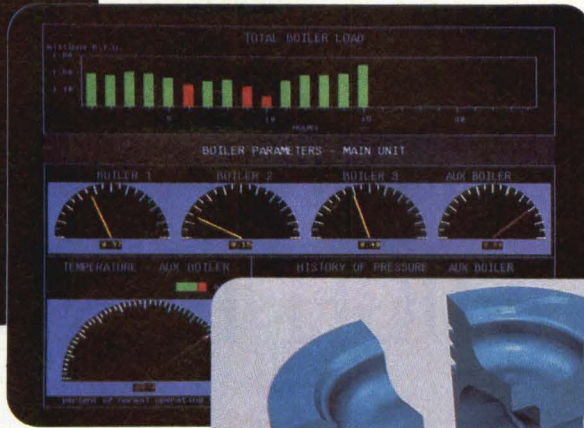

Raster's Model One/10.

High performance has rarely looked so good. Or cost so little.

Our high performance Model One/10 graphics terminal lets you run today's most popular engineering, technical and business presentation graphics software.

Programs like PATRAN, ANSYS, TEMPLATE, DI-3000, UNIRAS, DataViews, and TELL-A-GRAF, to name but a few.

What's more, Raster Technologies' Model One/10 is VT-100 compatible and emulates the Tektronix 4014.

And you don't have to pay a high price to get all its high performance features. Like a vector writing rate of over one million pixels/second. Support for 256 colors from a palette of 16.7 million with two additional overlay planes. Total image memory of 1024 x 512. 640 x 480 resolution on a 60 Hz flicker-free, non-interlaced 14" screen. Fully programmable look-up tables and more.

Just as important, you also get the application development tools made famous by the Model One family. With over 150 graphics commands, including local debugger, command interpreter, alphanumeric emulation and powerful local display list.

So call today. And watch your favorite programs for less.

Raster Technologies

The benchmark of computer graphics.

Nine Executive Park Drive
North Billerica, MA 01862
(617) 667-8900 TWX 710-347-0202
1-800-4RASTER



PATRAN is a trademark of PDA Engineering. TEMPLATE is a trademark of MEGATEK Corp. UNIRAS is a trademark of UNIRAS®, Inc. DataViews is a trademark of Visual Intelligence Corp. TELL-A-GRAF is a trademark of ISSCO. ANSYS is a trademark of SWANSON Analysis Corp. DI-3000 is a trademark of Precision Visuals, Inc.

CIRCLE NO. 57 ON INQUIRY CARD

WE WROTE THE BOOK ON HIGH PERFORMANCE.



VOLUME I

The Datasouth DS 180. The original high performance matrix printer. The printer that won international acclaim as the most rugged and dependable ever made.

And the printer made even better in the DS 180 Plus. Improved by enhancements like an 8-bit support capability and a new sound-dampening design.

The DS 180 Plus. The latest edition of the book we wrote on High Performance.

And that's only half the story.

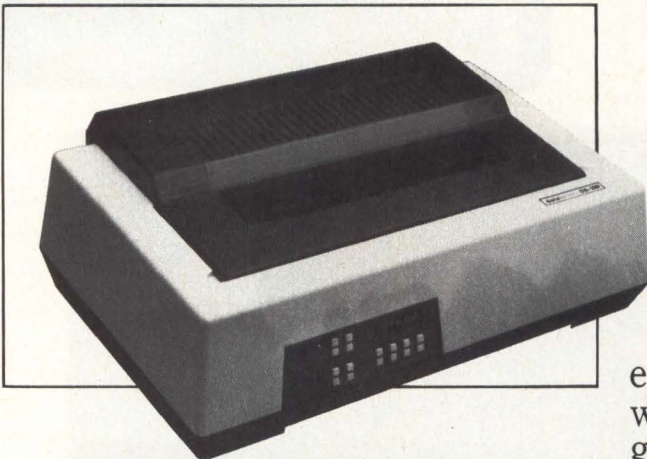

VOLUME II

The DS 220. The multi-mode matrix printer that brought Datasouth dependability to a variety of applications.

With servo-controlled logic and high speed tabbing to deliver faster data processing. Word processing copy to rival daisy-wheels. And high resolution dot addressable graphics.

The DS 220. The latest word in high performance multi-mode matrix printing.

From the company that wrote the whole book.

datasouth

H I G H P E R F O R M A N C E P R I N T E R S

AVAILABLE NATIONWIDE
THROUGH OUR NETWORK OF
SALES AND SERVICE DISTRIBUTORS

Datasouth Computer Corporation
Box 240947 • Charlotte, NC 28224
704/523-8500 • Tlx 6843018 DASOU UW

CALL TOLL FREE:
1-800-222-4528
Extension number 589

STATE-OF-THE-MARKET REPORT: PERSONAL COMPUTER SOFTWARE

several applications to be combined, and (2) in what Dataquest's Evans calls "democratization of the user interface," which means the ability of an environment manager to shield the user from the operating system and the hardware, as opposed to its integrating capabilities. Market estimates from Dataquest show environment managers growing at a 136 percent compound annual rate, from \$7 million in 1984 to \$513.3 million in 1989.

TopView, from IBM's Entry Systems Division, is a single-user, multitasking extension to IBM's PC-DOS that allows the user to run several application programs at the same time and switch from one task to another or to view data from different applications in windows on a display.

Although existing programs can run under TopView, they cannot take advantage of TopView's features. In addition, IBM does not license TopView to other hardware vendors, so many industry watchers sense the beginning of an IBM proprietary operating system.

The TopView Programmer's Toolkit is a set of utilities for developing TopView applications. The tool kit includes specifications for accessing TopView's functions from application programs, support for pointing devices and specifications for creating windows. IBM also publishes a TopView Application Guide, listing more than 200 compatible, non-IBM applications.

On the plus side, TopView has the IBM name and a large installed base of PCs. Future Computing projects that 75,000 TopView packages will be sold in 1985, 200,000 in 1986 and 378,000 in 1987. On the minus side, TopView does not yet support a graphics interface and reportedly slows the system's overall performance.

Microsoft Windows, from Microsoft Corp., is a graphics-oriented environment manager that supports applications using windows, graphics and pointing devices. It is an extension to MS-DOS that provides multitasking through a feature that Microsoft calls "non-pre-emptive scheduling." This feature prevents arbitrary interrupts from occurring while a program is executing and requires the application to give up control of the CPU through the use of a "yield" call to Windows.

Windows includes graphics device interfaces to provide application developers with the means to support a rich graphics environment on a variety of devices. Existing programs that use standard MS-DOS, basic input/output system or TopView extension calls can run under Windows. The Developer's Toolkit, containing the Programmer's Guide and Reference Manual,

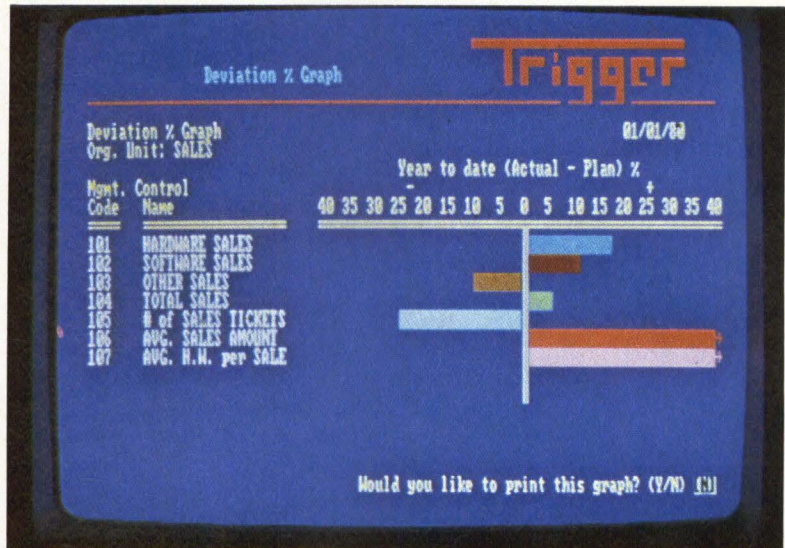

shows developers how to adapt Windows to different computers as well as how to rewrite applications.

In response to criticism that Windows is behind schedule, Rick Dill, product marketing group manager for Microsoft Corp. of Bellevue, Wash., says, "The January release of Windows was shipped to software developers on time, and the release has full application functionality with the final release, which will be shipped in June."

The Graphics Environment Manager (GEM) family of programs, from Digital Research Inc., is a graphics-based environment manager that transforms the text-based interface of single-tasking MS-DOS 2.0 and 3.0 environments into a Macintosh-like graphics interface. Technically, GEM is an operating system extension implemented as an application programming interface with windowing, data-interchange facilities, complete graphics-device support and user-interface primitives.

The GEM Desktop application program is a graphics interface that shields the user from DOS commands, a feature that Dataquest ranks very high in terms of user acceptance. GEM Desktop presents the user with a graphical representation of a desktop, complete with disks, a trash can, file folders and documents in user-controlled windows. A Programmer's Toolkit—a complete software development environment—allows programmers to develop turnkey applications.

Concurrent PC-DOS, also from Digital Research, is a multitasking operating system that allows a user to run as many as four PC-DOS or CP/M application programs at the same time. Concurrent PC-DOS uses fixed-time slicing to

Trigger's graphics mode displays exception and monitoring reports in a concise, easy-to-read form.

STATE-OF-THE-MARKET REPORT: PERSONAL COMPUTER SOFTWARE

Future Computing projects that 75,000 TopView packages will be sold in 1985, 200,000 in 1986 and 378,000 in 1987.

divide processor cycles among as many as four tasks that can reside simultaneously in memory. The user can view execution of the tasks through dynamic windows that can be scrolled, sized or placed anywhere on the screen.

Also included as a part of the system is a print spooler that can drive a printer and a plotter or two printers simultaneously, and a feature that allows two users to share the system.

User interfaces are important

User interfaces are independently written programs that place a shell or environment between the user and the application program. The large number of sales of the Macintosh computer from Apple Computer Inc. seems to indicate that users do want a graphical interface, including windows, pop-up or pull-down menus and pointing devices. On the broader horizontal front, graphical interfaces are simpler than the command-oriented interfaces provided by most application programs.

VisuALL, from Trillian Computer Corp., is a "menu-builder" user interface that incorporates a window environment with pop-up menus with or without the use of a mouse. The interface is wrapped around DOS and other programs, acting as a go-between between the software and the user. Software tasks are executed by pointing to their names in a pop-up window. While the menus are in use, they overlap the application that is being displayed. After a task is chosen, the menu disappears, and the original screen is restored.

Trillian markets three variations of the product. VisuALL Plus is a run-time version that includes interfaces to 1-2-3 and to MicroPro International Corp.'s WordStar and MS-DOS. The VisuALL Design Kit allows software developers to create window/pop-up menu interfaces

for any software programs. The Demo Generator is a high-level programming language that enables programmers to write "shows" that can run concurrently with other applications. For example, a show can act as a tutorial and run in parallel with the application software that is being demonstrated.

Clout, from Microrim, is a natural-language query program designed to work with files from many popular application software packages. Clout allows the user to analyze data from Microrim's R:base, dBASE II, PFS:File, 1-2-3, document interchange format files from VisiCorp's VisiCalc and Symphony, and SYLK files from Microsoft's Multiplan.

A user can adapt Clout to an application by adding as many as 500 phrases, formulas or synonyms to customize Clout's 300-word vocabulary. To access files created by programs other than R:base, a feature called FileGateway copies and translates files into a format that Clout understands. Clout is a query-only interface, and it is most useful for ad hoc queries.

Decision modeling proves popular

"Artificial intelligence," "knowledge bases" and "expert systems" are terms that are creeping into the lexicon of personal computer software. These are not formal AI programs. They use the conventional number crunching of spreadsheets and Boolean relational operations of databases but "hide" them behind an expert system-type user interface.

"Decision modeling" refers to the ability of the software to build decision-making models that incorporate such knowledge as plans, goals, decision-making criteria and values, with the ability to act upon that knowledge, such as "triggering" a response or choosing a course of action. Developers of decision-modeling software are promoting it as a new general-purpose category similar in scope to spreadsheets or database programs. According to Future Computing's Ward, "The value-added channel may be the best channel for these types of products, although their sales are still too small to show up in retail channel surveys."

Lightyear, from Lightyear Inc., Santa Clara, Calif., is a decision-modeling package designed to meet the needs of executives who want to analyze their decision-making processes. The program's three-tiered decision model functions somewhat as follows. The user first lists the categories, such as a list of employees up for review. Second, criteria for each category are, such as salary level, job qualifications and so on, are entered. Third, the user is asked to weigh the

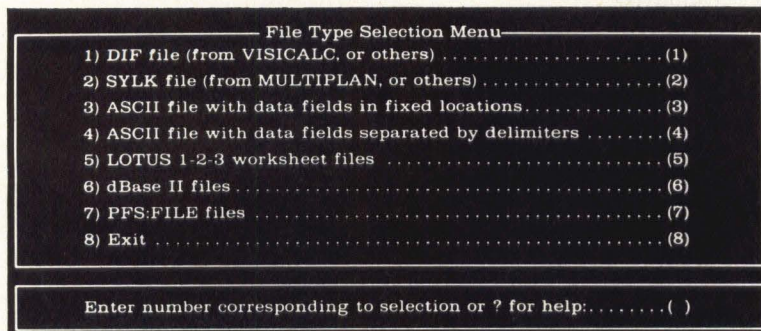

Clout features FileGateway, a program that allows the user to access files created by programs other than Microrim's R:base database-management program.

SyQuest- the best in Winchester. Inside and Out.

Fixed

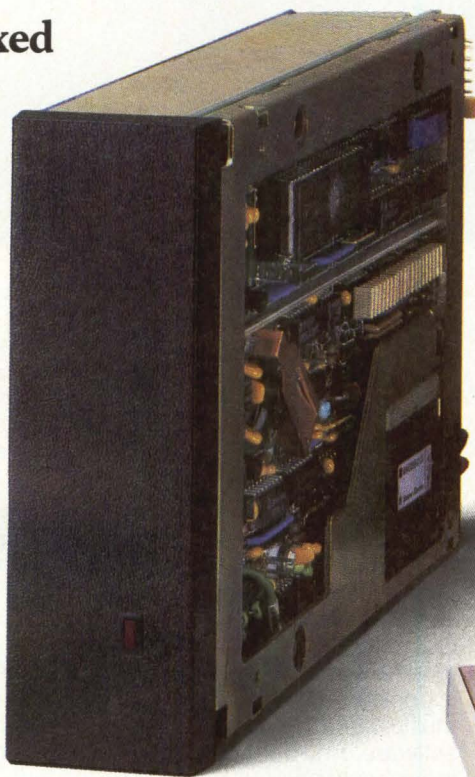

Removable

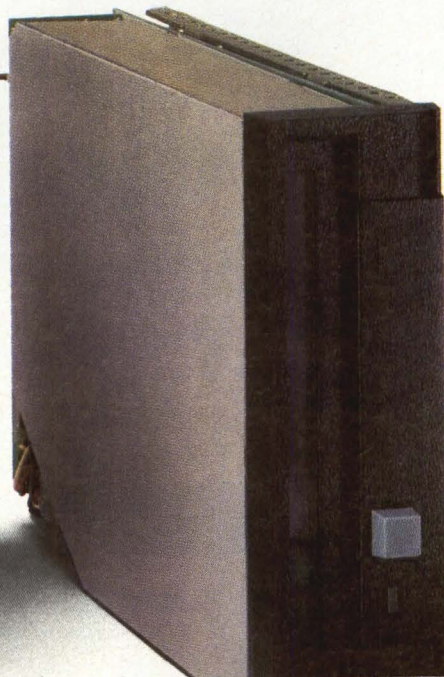

When you've already done the impossible in Winchester design and production, doing the difficult is no problem. That's why SyQuest can lay claim to the top quality half-height Winchester disk drives—removable *and* fixed.

SyQuest 6.38 and 12.76MByte removable cartridge Winchesters, the product many said couldn't be done, are setting the standard of the industry in quality, reliability and performance. Only 4.8 inches wide and 1.625 inches high, they can be configured for a sub 5 1/4-inch or standard 5 1/4-inch half-height footprint. More than 60,000 of these drives have been delivered to date for on-line, random access storage. Combining a unique stepper motor positioner with servo control and the ultrareliability of graphite-sputtered, plated media, SyQuest half-height cartridge drives make the impossible possible.

SyQuest half-height fixed disk drives give 25.5 and 38.2MBytes of data storage with the same innovative, yet conservative, design concept. Like our cartridge drives, they are tested and qualified far beyond industry standards. What other manufacturers are finding difficult, SyQuest can deliver today.

So when you need Winchester in a 5 1/4-inch footprint or smaller—come to the leader. SyQuest, the best in Winchester—inside and out.

SyQuest Technology, 47923 Warm Springs Blvd., Fremont, California 94539. (415) 490-7511, TWX 910-381-7027.

Model	Fixed/Removable	Unformatted	Formatted
SQ306RD	Removable	6.38MByte	5.00MByte
SQ312RD	Removable	12.76MByte	10.00MByte
SQ325F	Fixed	25.50MByte	20.00MByte
SQ338F	Fixed	38.20MByte	30.00MByte



SyQuest
TECHNOLOGY

Winchester at its best.

See us at Booth #3124 ★ NCC '85 McCormick Place East
CIRCLE NO. 59 ON INQUIRY CARD

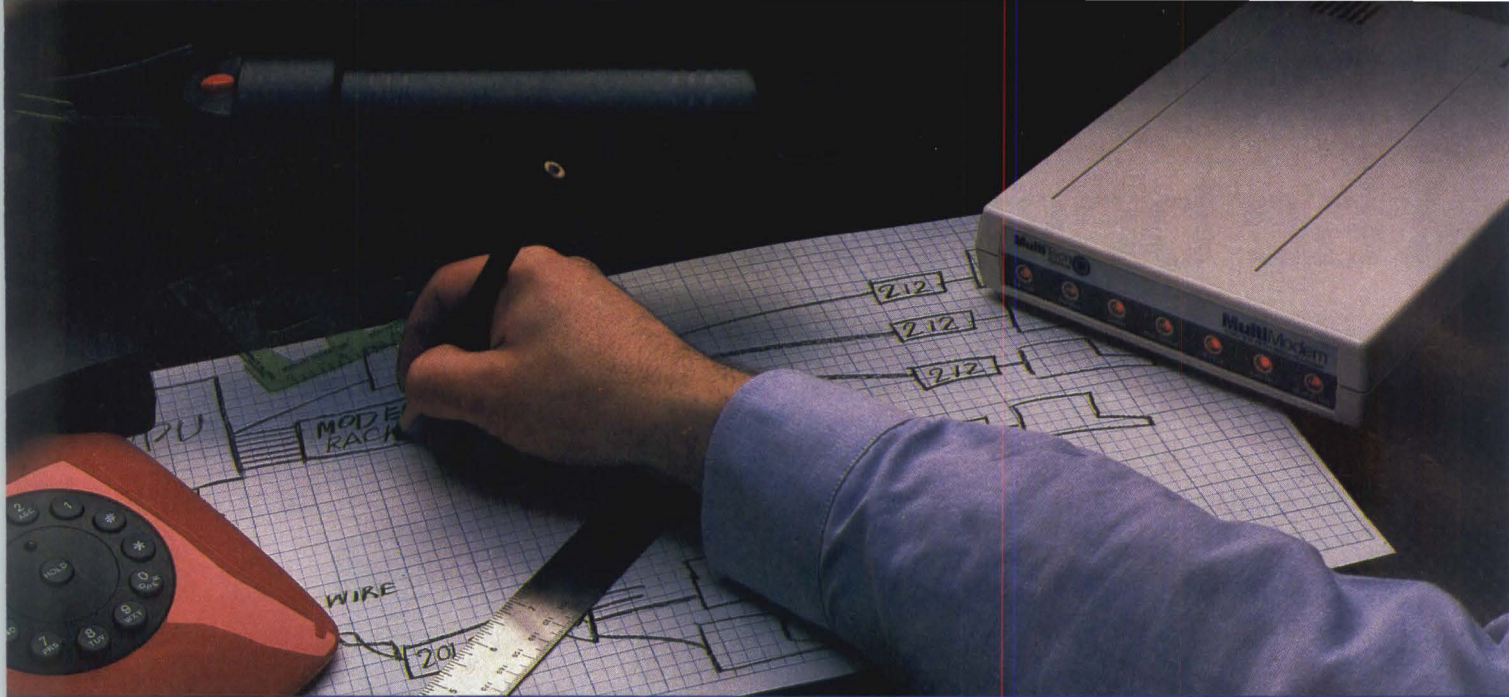

Is this the year of the Modem?

- If you aren't already including modems in your systems, maybe you should be. Because whether you do or not, there is an increasing user demand for on-line capability. This trend will make communications a selling advantage for you now, and an absolute necessity in the not-too-distant future. Communications can now expand the potential of your systems, without creating more headaches for you.

- When looking for a communications supplier, experience and support can be as important as price. Multi-Tech Systems has been providing modems and other datacomm equipment to systems integrators since 1970. Our Technical Support people are second to none. Our products include 300, 1200 and 2400 bps intelligent modems (Hayes-compatible autodial and auto-answer, in desktop, in-board and rack-mount versions), multiplexers, breakout boxes and communications software. And our prices (and margins) are right where they should be.

- So whether your systems are for your own use, or you sell systems to others, Multi-Tech modems can make them better. On-line software updates and maintenance make life easier for you, and on-line capability provides better system versatility for your users.

- Why not let Multi-Tech help make this year of the modem your best year yet?

CIRCLE NO. 60 ON INQUIRY CARD

MultiTech
Systems

The right answer every time.

82 Second Ave. S.E., New Brighton, MN 55112 (612) 631-3550. TWX: 910-563-3610

MultiTech
Systems

MultiModem
1200/300 BPS Intelligent Modem

STATE-OF-THE-MARKET REPORT:
PERSONAL COMPUTER SOFTWARE

alternatives, e.g., diversity of experience compared to length of employment. The program assigns numerical values to the criteria and weighted alternatives, and, after all the criteria and weighted alternatives have been entered, the program uses arithmetic in number-crunching fashion to produce a recommended course of action.

"Lightyear has just begun to address the needs of value adders in vertical markets," says Barry Smith, vice president of marketing for Lightyear. "We're working with a commodities trading expert and Dow Jones Inc. to develop an application for commodity traders and commodity buyers." Smith also says that VARs that are already marketing 1-2-3 and dBASE templates have shown an interest in building Lightyear models as an additional product in their offerings.

Trigger, from Thoughtware Inc., Coconut Grove, Fla., is a management-by-exception reporting and monitoring system that helps the user develop a plan, monitor the results, identify situations in which managerial action is needed and analyze the effectiveness of prior manage-

ment actions.

Thoughtware recently began implementing a value-added marketing program for Trigger. According to Jack Levine, president of Thoughtware, "Trigger is an ideal vehicle for people who have specific industry knowledge and is therefore a logical product for the value-added market. It can easily be tailored to a specific industry and become an easy-to-use vertical application." A real estate expert, for example, could create a Trigger template that would turn Trigger into a real estate-management and -reporting system.

The market for personal computer software continues to grow at astronomical rates. With such a wide variety of personal computer software companies gearing their products and marketing approaches toward VARs, and with last year's tightening of the retail channel, 1985 may turn out to be the year of the value-added channel for the personal computer industry. □

Interest Quotient (Circle One)
 High 468 Medium 469 Low 470

Robert H. Blissmer is a Brookline, Mass.-based consultant, writer and software designer.

BIG THINGS COME IN SMALL PACKAGES. BUT ONLY IF THEY'RE ON TIME.

DELTA DASH. SAME DAY DELIVERY OF SMALL PACKAGES.

When tomorrow's too late, little things can suddenly become very important.

And time sensitive.

So you turn to Delta DASH for same-day delivery.

Any package—under 70 lbs.

—that is shipped during normal business hours will arrive that same day.

But what about the time you waste taking the package to the airport? Or arranging for a courier service? Delta's got the answer.

DOOR TO DOOR PICK UP AND DELIVERY.

Delta DASH offers you door to door pick up and delivery. And DASH delivers to over 100 cities and over 10,000 communities—all over the U.S. So you know your package will get there.



If your package is larger than 70 lbs., call Delta Air Express. We'll guarantee your shipment on the flight specified.

So let Delta do the work for you. Just call Delta DASH toll-free at 800-638-7333; in Baltimore call 269-6393. With Delta DASH, time is on your side.

**SAME DAY DASH.
 DELTA TAKES IT THERE.™**



AZAK is more than a new standard. It's a foundation.

Behind every AZAK thin film disk is a commitment that assures its quality.

It's the commitment of a company to consistently provide a product with quality that meets or exceeds customer expectations — both at delivery and throughout the product's service life.

It's a commitment reflected in a new, \$30-million-plus manufacturing facility dedicated solely to hard disk production.

It's a commitment backed by the resources of the 800,000-square-foot ALCOA technical center — one of the largest of its kind in the world — where new alloys and manufacturing methods are constantly being developed.

And it's a commitment that recognizes only one certainty in the computer business: that today's standards will surely be replaced by next week's innovation. The Memory Products Division of The Stolle Corporation is uniquely positioned to be the source of innovations which will help expand the capacity of tomorrow's computers.

That's why AZAK not only represents a new standard in thin film media performance. It is the foundation for media to come.

AZAK 5¼-inch thin film disks are available now for your testing and evaluation. For complete technical information and samples, call 513-498-6215. Or, using your company letterhead, write Memory Products Division, STOLLE CORP., 1501 Michigan Street, Sidney, OH 45365.

AZAK

Thin Film Media

Every bit better.

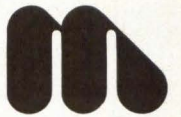
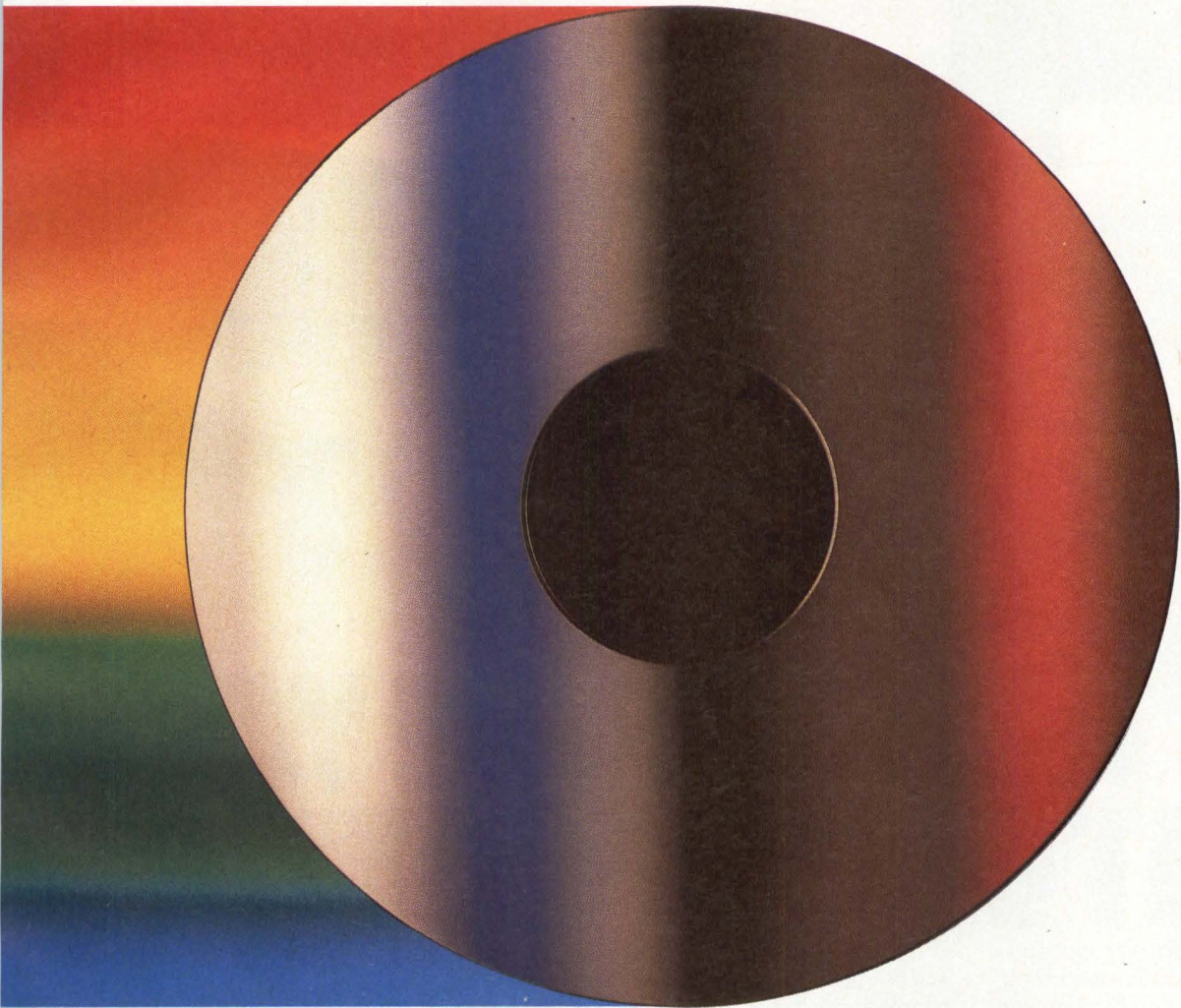

MEMORY
PRODUCTS
DIVISION

The Stolle
Corporation

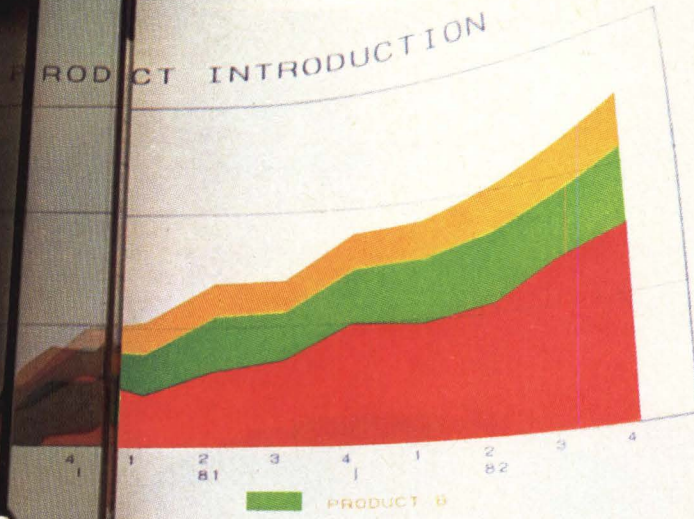

GET THE PICTURE WITH FACIT 6-PEN PLOTTERS

Multicolour graphics on paper and overhead transparency film are now a reality at a price every computer owner can afford – with the new Facit 4550 and Facit 4551 Pen Plotters.

The 6-pen cassette design provides instant colour changes with a multitude of colour set-ups. Longlife ballpoint for paper, oil-based fiber-tip for transparencies and water-based ceramic pens for high-quality CAD drawings are available with 8 to 12 different colours. Two pen-cassettes can be stored in pockets on top of the casing. The pens are securely sealed to prevent drying.

Business graphics, CAD, CAE, science and engineering plottings are handled with a character resolution as high as 10x10 elements per character. Facit 4550 accepts media sizes ISO A4 or 8 1/2 x 11", while Facit 4551 takes media up to ISO A3 or 11 x 17".

FRIENDS WITH ALL MAJOR COMPUTERS

With HP-Graphic Language emulation and serial/parallel interfaces, the plotters easily make friends with all major computer models on the market. Software packages include Lotus 1-2-3, Symphony, Fast Graphs, DR Draw/Graph, BPS, etc.

Symphony, Fast Graphs, DR Draw/Graph, BPS, etc.

Got the picture? Get it at your nearest Facit representative!

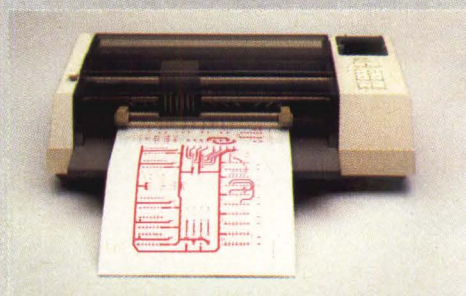

FACIT

CIRCLE NO. 62 ON INQUIRY CARD

Head Office: Facit AB, S-17291 Sundbyberg, Sweden. Phone: (8) 7643000. USA: Facit Inc. P.O. Box 334, Merrimack, NH 03054. Phone: (603) 424-8000

IBM, APPLE RULE OFFICE MARKET

Burgeoning to \$10 billion in 1984,
the office personal computer market boom shows no signs
of abating, despite minor shakeouts

William F. Ablondi and **Laura Lundquist**
Future Computing Inc.

From modest beginnings in the mid-1970s, the U.S. market for both office and home personal computer hardware and software grew to more than \$16 billion in 1984. The market is expected to grow at an average annual rate of 26 percent per year between now and 1989, reaching more than \$53 billion in 1989.

The phenomenal growth of the personal computer market has generated opportunities for start-up companies as well as for established manufacturers of larger computer systems and of other electronic or telecommunications equipment. Opportunities include software publishing and the manufacture of peripheral devices, computer furniture and accessories and supplies, in addition to making and selling the personal computers. Service-related businesses such as maintenance and training have sprung up, and an entirely new print publishing industry focusing on personal computers has evolved.

In 1984, the U.S. office market segment alone was valued at \$10 billion, representing approximately 2.7 million personal computers—that's nearly a million more units than in 1983. By the end of the decade, annual unit shipments will climb to about 10 million, generating revenues of over \$30 billion at the end-user level.

Floppy disk-based office personal computers accounted for 57 percent of the market in 1984, but their share will decrease to 44 percent by 1989. The market for Winchester disk personal computers, including local area network servers,

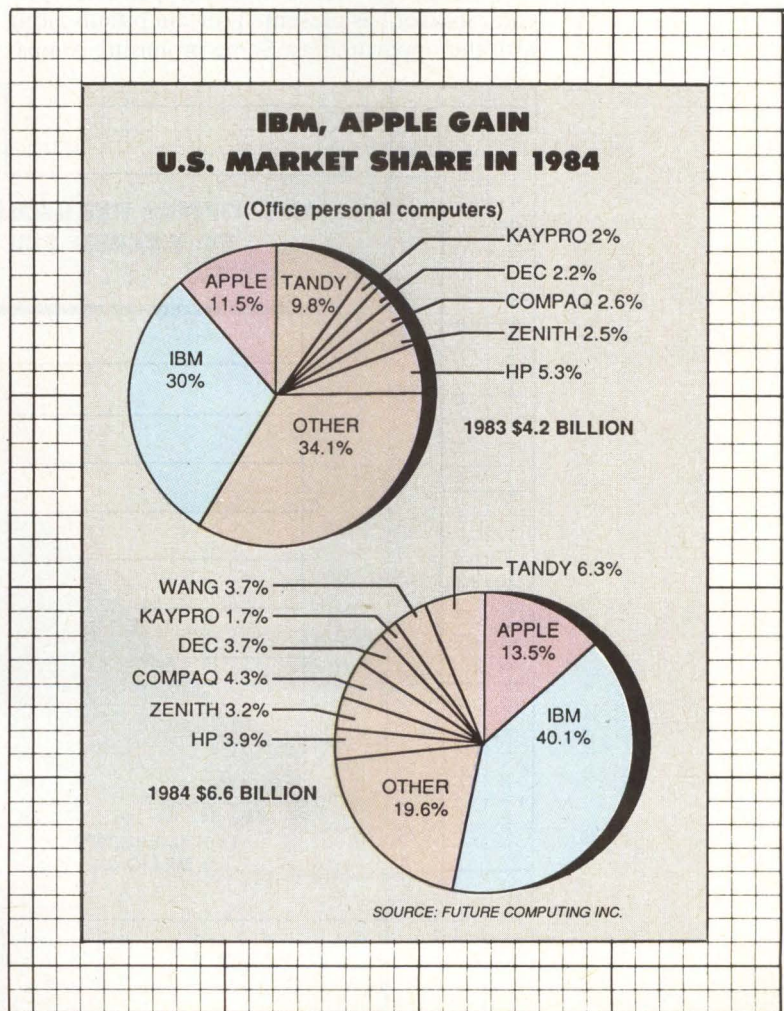

STATE-OF-THE-MARKET REPORT: **PERSONAL COMPUTERS**

In the late 1980s and early 1990s, the number of new entrants will dwindle, and a shakeout of competitors is likely.

shared processor systems and standalone personal computers, is growing at an annual rate of 28 percent and will increase from 40 percent of the market in 1984 to approximately 44 percent in 1989. Battery-powered personal computers will make up the remainder, accounting for about 11 percent of the office personal computer market value in 1989.

The ratio of Winchester disk personal computer shipments to floppy disk personal computer shipments in 1983 was 1-to-5. That ratio is steadily declining and will likely shrink from 1-to-4 in 1984 to 1-to-2.3 in 1989.

Battery-powered unit shipments in 1989 will be more than 12 times the 1984 total of 170,000. The percentage of battery-powered shipments that are briefcase-sized units will peak in 1986 at 54 percent, decreasing to 52 percent in the following years, as improving technology increases the functionality of book-sized computers.

The rapid growth of the office personal computer market has presented certain pitfalls along with the opportunities. Some promising compa-

nies have been forced to file bankruptcy, liquidate their assets or simply withdraw from the personal computer industry.

In 1983, Osborne Computer Corp., which introduced the first transportable computer, became the first well-known player within the industry to file for Chapter 11 bankruptcy. A reorganized Osborne has recently announced plans to stage a cautious comeback with the introduction of a personal computer called Vixen and with a possible stock offering.

Similarly, two of the top 10 U.S. computer manufacturers of 1983—Franklin Computer Corp. and Victor Technologies Inc.—declared Chapter 11 in 1984. Smaller companies to leave the industry in 1984 include Comterm Inc.'s Bytec division, Gavilan Computer Corp. and Otrona Corp.

In a young and rapidly expanding industry, there is a tendency to generalize from such failures and to blame the market environment rather than factors peculiar to the failed companies. Of the recent failures, three companies—Bytec, Gavilan and Otrona—were small, mod-

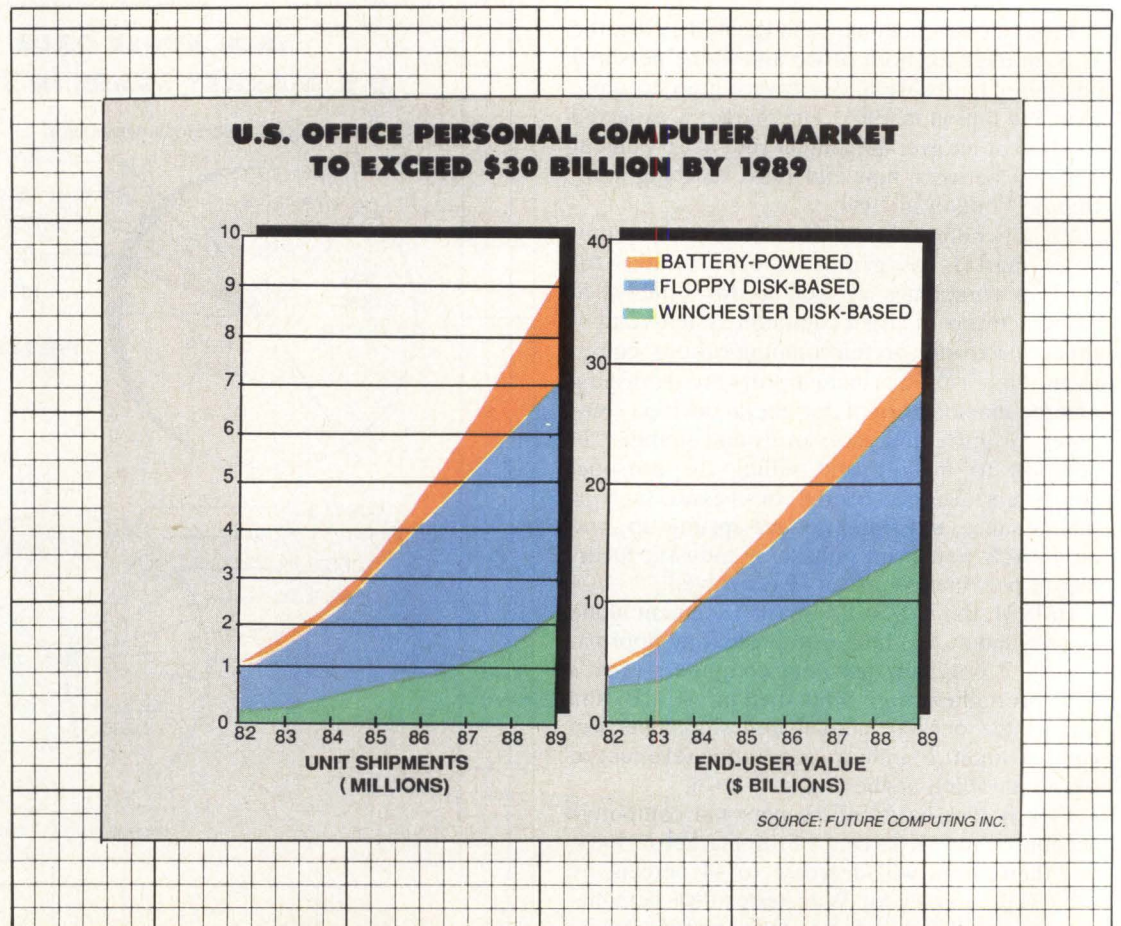

WHETSTONE[®] delivers 10 MIPS throughput:

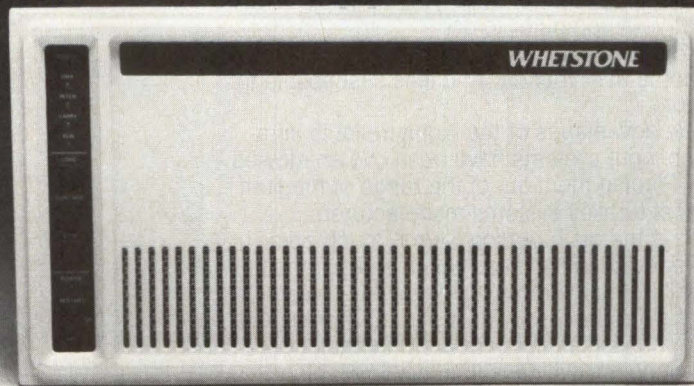

— today, not "someday."

That's right: 10 million instructions per second. Whetstone[®] is four times faster than any other minicomputer that's ever been built, and more than twice as fast as any ever designed. Which may save your system's life if you're searching for more power.

Like when productivity is declining because there's a bottleneck at the processor. Or when you've grown from eight terminals in your system to 32, and need still more. Or when your application demands real-time response, or interactivity, or graphics.

Fortunately, the help you need is available, now. Whetstone is completely documented and ready to ship within 30 days ARO. Not "in a few months," as some manufacturers have been known to say. No prolonged delivery schedules!

These comparisons demonstrate WHETSTONE's throughput capability:

But the comparison that really matters is the one that runs your own applications. Call us at 714/993-5300 and you'll receive the CPU that solves your throughput problems today — not "someday."

WHETSTONE. The mini-mainframe so fast, so powerful, we put its performance criterion right in the name.

Once you've made your own comparison, we believe you'll see why.

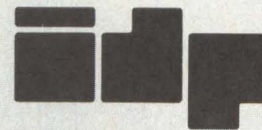

Integrated Digital Products

4208 East La Palma Avenue • Anaheim, California 92807
714/993-5300

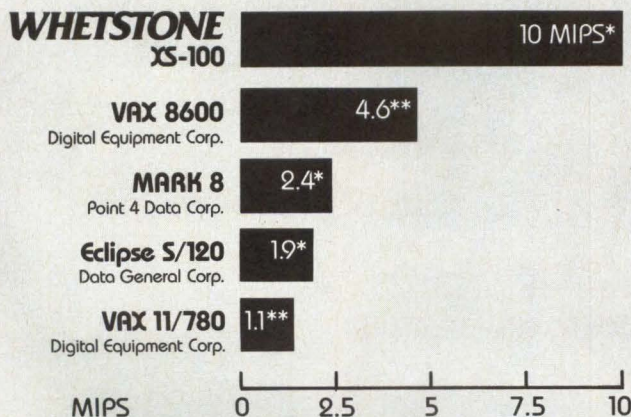

*Ratings derived from independent benchmark tests conducted by Command Control & Communications Corporation, Torrance, California.

**DEC Professional Magazine, December, 1984.

Features

- 100 nanosecond instruction execution (10 MIPS) with 33 nSec. subcycles. Also available in 125 nSec. and 150 nSec. versions.
- Cost-effective, hierarchical memory: 128-512 KB, high-speed (100 nSec.) main memory; up to 32 MB extended memory (500 nSec.) per processor.
- Advanced, pipelined architecture with fully-overlapped memory access and instruction execution.
- Continuous processing during channel transfers.
- Built-in self-test.

Trademarks: ownership. WHETSTONE: Integrated Digital Products Corp. VAX: Digital Equipment Corp. MARK 8: Point 4 Data Corp. Eclipse: Data General Corp.

© Copyright 1985, Integrated Digital Products Corp.

CIRCLE NO. 63 ON INQUIRY CARD



Our Smart-Frame™ will put you in touch.

Carroll Touch

a subsidiary of AMP Incorporated

In Touch with Technology

One of the easiest ways to interact with a computer is through a touch activated display. One that lets you merely point your finger at what you want your computer to do.

With touch, even the most complex application can become user friendly. And less susceptible to user error.

But the advantages of the highly reliable infrared touch input systems have been overshadowed by cost. Placing them out of the range of medium to low-cost turnkey systems manufacturers.

Which is the main reason Carroll Touch completely redesigned its line of touch input products.

We call it Smart-Frame™. Because it contains a powerful microprocessor built into the frame. And because it uses scanning infrared technology—a touch technology which is incredibly reliable, rugged, accurate, and fast. A technology Carroll Touch pioneered and refined.

As a result of the Smart-Frame design, Carroll Touch units contain 45 percent fewer components than before. Which means the cost to you is about 50 percent lower too.

We think that's pretty smart. And Carroll Touch did it just so you could get in touch. Today.

P.O. Box 1309
Round Rock, Texas 78680
512/244-3500, Telex 881906

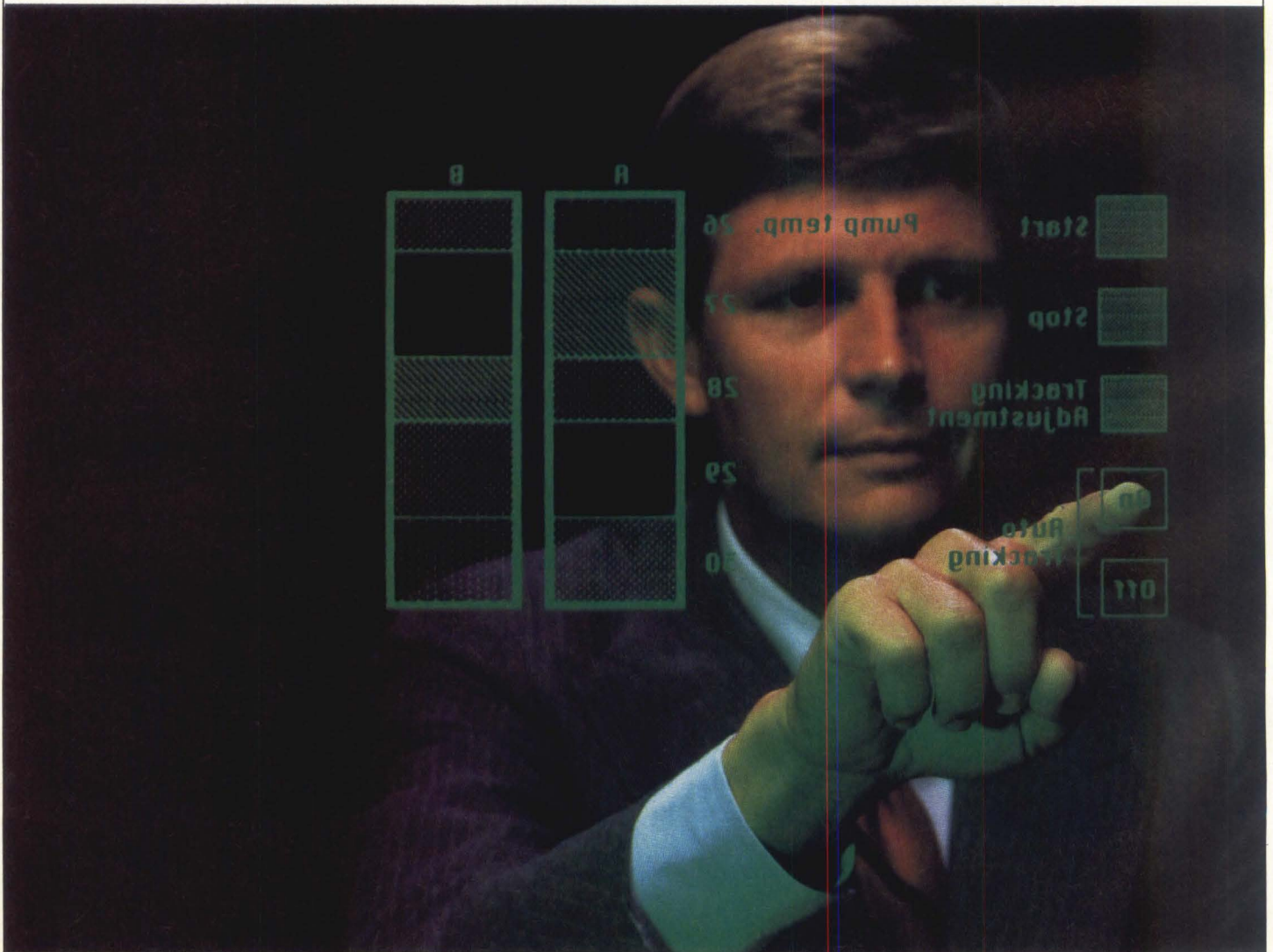

STATE-OF-THE-MARKET REPORT:
PERSONAL COMPUTERS

estly capitalized companies that were almost exclusively dependent on one product. The combination of these factors made them vulnerable to normal shifts in the market. A fourth company, Franklin, was severely damaged by the costly settlement of a lawsuit with Apple Computer Inc. over the design of Franklin's ROM BIOS.

Despite the emphasis given by the press to these failures, Future Computing does not believe that these occurrences are characteristic of an industry-wide shakeout in the industry.

The next three years should be a period of competitive turbulence in the personal computer industry, during which a number of companies enter the marketplace, as weaker competitors fail. Some of these new entrants—such as AT&T, ITT and Sperry Corp.—have much greater financial, technical and marketing resources than those companies that have recently dropped out.

In the late 1980s and early 1990s, the number of new entrants will dwindle, and a shakeout of competitors is likely. Although annual unit sales

will continue to increase, the growth curve will flatten as sales to first-time buyers decline in the late 1980s and annual unit sales become more dependent upon replacement sales. Future Computing estimates that the average user will keep a system four to five years before replacing it. As replacement sales become more important, manufacturers will shift to commodity marketing tactics to defend, and to resell to, their installed bases. Although there will be less room for marketing errors in the late 1980s and early 1990s, there will continue to be a number of successful participants at all industry levels.

Apple II leads

In 1983, the most popular office personal computer was clearly Apple Computer's Apple IIe, which sold more than 570,000 units that year. More than 50 percent of the IIes were purchased for use in offices. Next in unit sales was IBM Corp.'s PC, of which just under 400,000 units were sold in the United States in 1983. Following the IBM PC was the TRS-80

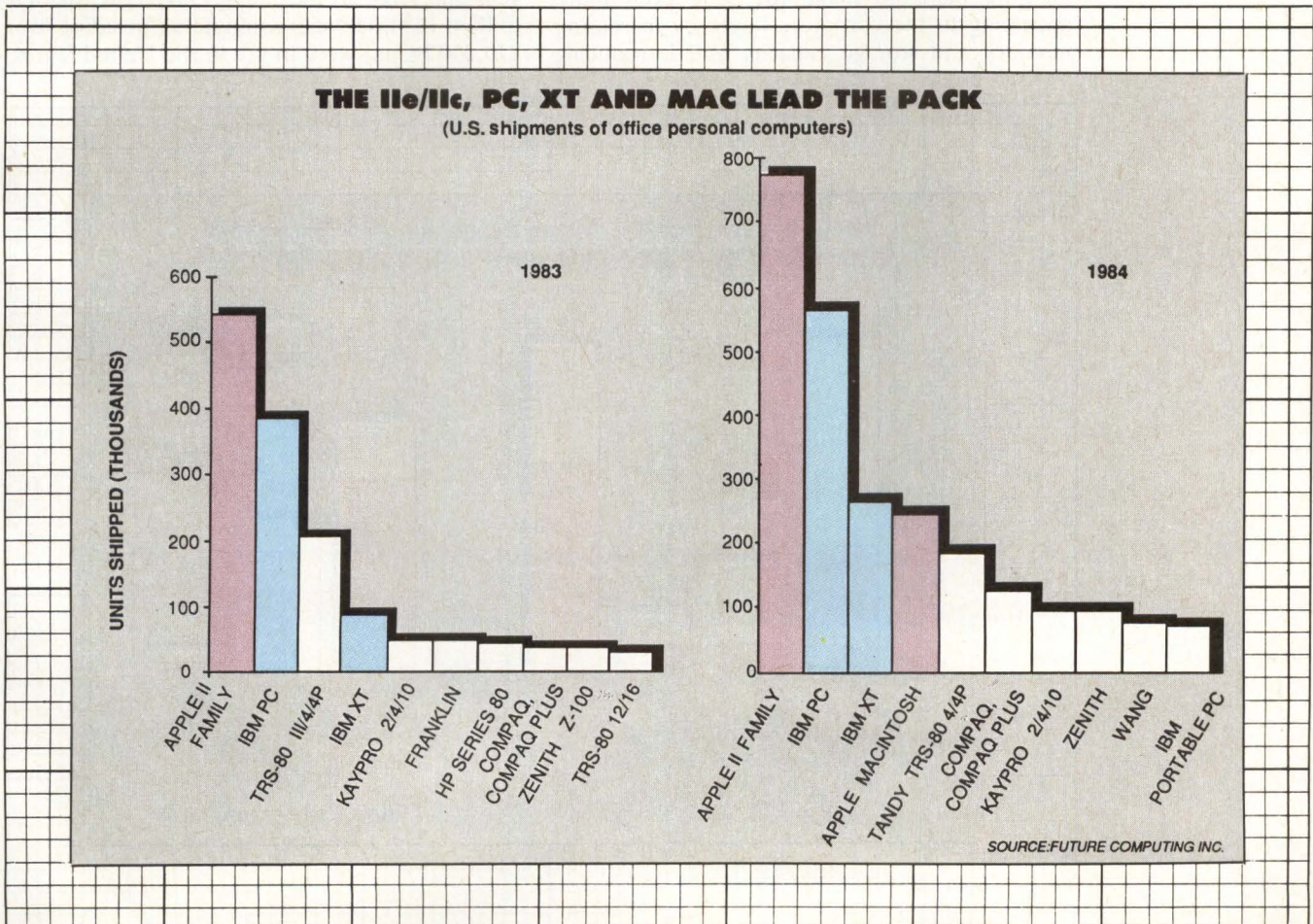

STATE-OF-THE-MARKET REPORT:
PERSONAL COMPUTERS

In 1984, the Apple II family of products again topped the list of leaders.

III/4P family of Tandy Corp.'s Radio Shack division, of which just over 200,000 units were sold.

Both IBM and Tandy had another product in the top 10 in 1983. IBM sold over 90,000 XT's, and Tandy sold nearly 37,000 TRS-80 models 12 and 16. Clearly, Apple, IBM and Tandy were that year's big three of the office personal computer industry.

In 1984, the Apple II family of products again topped the list of leaders. Although the Apple II family is now targeted primarily for home use, a substantial number of Apple IIs/IIs are being used in office applications.

The IBM PC was the next-best-selling office personal computer in 1984. Shipments of the PC totaled more than 565,000 units, a 40 percent growth in unit sales over 1983. The IBM PC/XT followed the PC in sales, with more than 275,000 units shipped in the United States in 1984. Sales of the Apple Macintosh totaled more than 230,000 in 1984 and should reach 500,000 by the end of this year. Apple recently began implementing plans to make the Mac even more appealing to the corporate buyer by increasing memory and storage capacity and introducing

the AppleTalk network. In addition, software for the Macintosh is growing in availability.

In 1983, Tandy's TRS-80 III/4P family was in third position. In 1984, it dropped to fifth place, with sales of over 180,000 units. The Compaq and Compaq Plus transportable from Compaq Computer Corp. sold over 125,000 units in 1984, putting the company in sixth place.

The total number of office personal computers in use in the United States grew from fewer than four million at the end of 1983 to over 6 million by the end of 1984.

The Apple II family had the largest installed office base at the end of 1984, with over 1.9 million units in the United States and more than 2.3 million units in use worldwide. Based on recent surveys, Future Computing estimates that about 50 percent of the Apple IIs/IIs are being used in offices.

With such a large percentage of the Apple II family in homes and educational institutions, the IBM PC family actually had the largest installed base of all personal computers in offices at year-end 1984. By the end of 1984, more than 1.9 million IBM personal computers (including over 270,000 PCjrs) were in use in the United States,

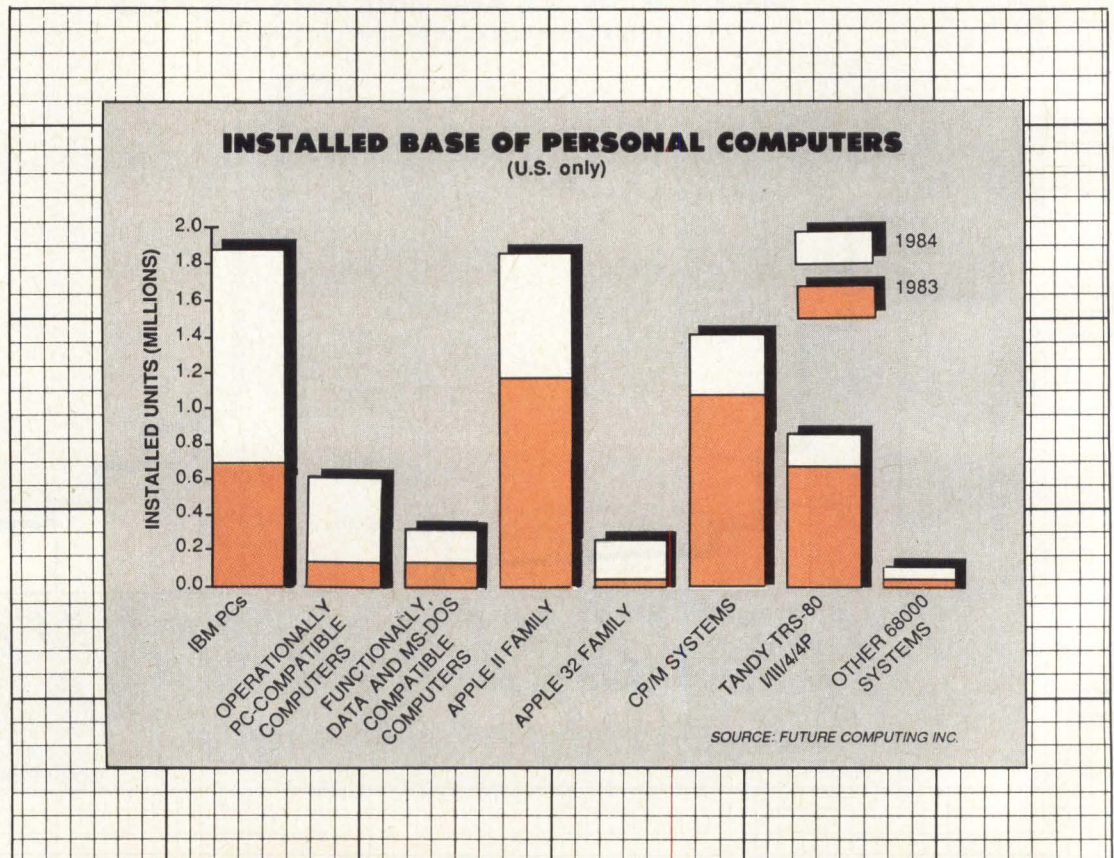

5¼" Technology

Mitsubishi Presents

High Volume. High Capacity.

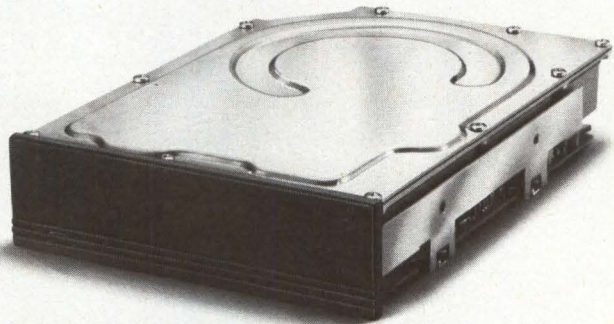
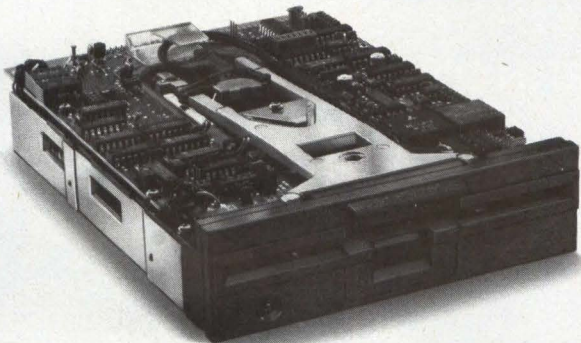

Mitsubishi floppy disk drives are being shipped in volume at a rate of more than 100,000 per month.

That's more than a million a year.

Why? Because we're meeting the requirements demanded by some of the fastest growing and biggest OEMs in the business.

A full-line of quality 5¼" floppy drives from ½ to 2 megabytes, plus 3½" and 8" models are available in quantity.

	.5	1	1.6	2 (Mb)	
3½"	MF351		Model Number		
	M4851				
5¼"	M4853				
					M4854
					M4855
8"					M2894
					M2896

Mitsubishi 5¼" half-height rigid disk drives are available with 12.75Mb and 25.5Mb of storage.

The MR521 and MR522 are rigid disk drives with the capacity and performance you want. Plus extra reliability.

Reliability. The kind Mitsubishi rigid and flexible disk drives are known for. You see, Mitsubishi isn't just a disk drive assembler. Our experience includes designing and manufacturing disk drive components such as read-write heads, spindle and stepper motors, ICs and more.

In fact, we've been producing disk drives for over 20 years. We over-spec to ensure quality. So if you are looking for high volume or high capacity, call the problem solvers at Mitsubishi.

For full information, contact Mitsubishi Electronics America, Inc., Computer Peripherals Division, 991 Knox Street, Torrance, CA 90502. Or call (213) 515-3993.

Mitsubishi Sales Offices

Atlanta, GA (404) 448-1263

Boston, MA (617) 938-1220

Dallas, TX (214) 258-1266

Los Angeles, CA (213) 515-3993

Minneapolis, MN (612) 938-7779

Salt Lake City, UT (801) 531-9481

Piscataway, NJ (201) 981-1414

Sunnyvale, CA (408) 730-5900

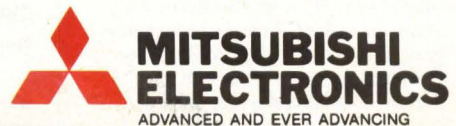

ADVANCED AND EVER ADVANCING

Visit us at NCC-Booth #6221

CIRCLE NO. 65 ON INQUIRY CARD

**STATE-OF-THE-MARKET REPORT:
PERSONAL COMPUTERS**

which is well over twice the 700,000 that were in use at the end of 1983.

The installed base of IBM PC-compatible computers also experienced significant growth in 1984. Growth of operationally PC-compatible computers far outstripped growth of functionally, data- and MS-DOS-compatible computers. (Operationally compatible computers, such as Compaq Computer's systems, are fully compatible with the IBM PC. Functionally compatible computers require some modification of software programs before they can run on the PC.)

Future Computing estimates that by the end of 1984, there were nearly 650,000 operationally compatible computers in use in the United States. Functionally and data-compatible computers, on the other hand, had an installed base of approximately 365,000 units. The preponderance of operationally compatible computers over functionally, data- and MS-DOS-compatible computers is expected to increase substantially as the marketing of a "PC-compatible" computer that is less than operationally compatible becomes less and less successful.

CP/M-based systems had the second largest installed base at year-end 1983, with nearly 1.1 million units in place. Only about 350,000 CP/M

systems were shipped in 1984, which caused the category to slip into third place behind the IBM PC family. Although the sale of CP/M-based systems has slowed, due primarily to their having been outstripped by faster systems, CP/M-based systems are still an important target for software development because of the large installed base.

Commodore Business Machines Inc. introduced a line of products at the January 1985 Consumer Electronics Show. The new high-end product of the line is the Commodore 128 personal computer, which has two microprocessors—the 8502 (6502-compatible) and the Z80A. This system can run either Commodore 64 or CP/M programs. If this product is successful, it could improve opportunities for software targeted for CP/M machines.

In 1983, the Apple 32-bit family consisted of only the Apple Lisa. In January 1984, the family received a boost with the introduction of the Macintosh. Approximately 230,000 Macintoshes were sold in 1984 in the United States, bringing the installed base of the Apple 32 family to about 260,000.

IBM was clearly the leading sales leader in 1984, with domestic personal computer revenues of approximately \$2.7 billion, excluding the

IBM was the clear leader with U.S. personal computer revenues of approximately \$2.7 billion in 1984, excluding the PCjr.

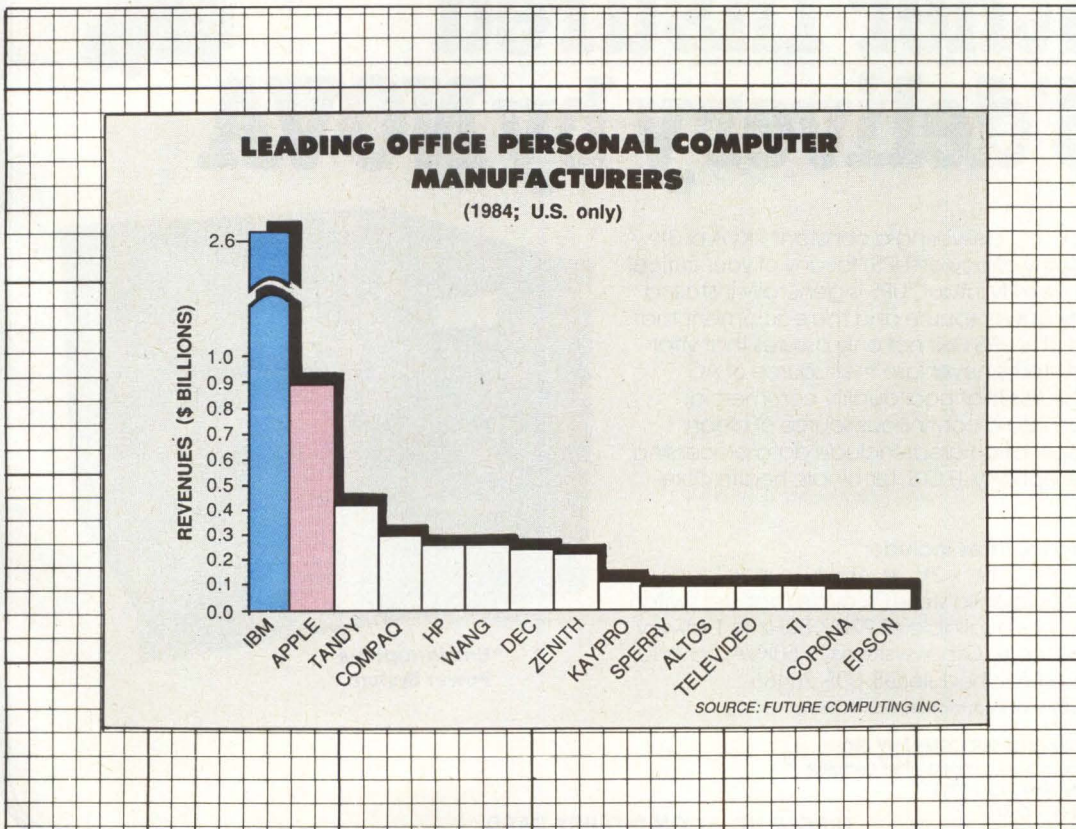

STATE-OF-THE-MARKET REPORT:
PERSONAL COMPUTERS

PCjr. The PCjr contributed nearly \$200 million more in revenues. Next in line was Apple, with 1984 revenues from the office marketplace of approximately \$900 million. When software and total Apple II family sales are included, Apple's total U.S. revenues reached more than \$1.5 billion for calendar year 1984.

Tandy's Radio Shack ranked third with more than \$420 million in office personal computer revenues. Office personal computer revenues represented about 50 percent of Tandy's total personal computer-related revenues in calendar year 1984, with the remainder being software, peripherals and home computers.

Compaq was No. 4 in sales of office personal computers in the United States in 1984. Sales of the Compaq and Compaq Plus transportables contributed more than 85 percent of revenue, with the Deskpro accounting for the remainder. Hewlett-Packard Co. followed Compaq with U.S. sales of approximately \$260 million in personal computer revenues for the year. International sales of HP products accounted for about

50 percent of the company's personal computer revenues.

The next three companies in order of sales—Wang Laboratories Inc., Digital Equipment Corp. and Zenith Data Systems—all had personal computer revenues exceeding \$200 million in 1984. Kaypro Corp., Sperry Corp., Altos Computer Systems, TeleVideo Systems Inc. and Texas Instruments Inc. followed. Corona Data Systems Inc. and Epson America Inc. did not quite reach the \$90 million level during 1984, nor did AT&T, which posted sales of \$70 million to \$75 million for its PC 6300. □

William F. Ablondi is vice president and **Laura Lundquist** is an analyst, Markets Group, with Future Computing Inc., Dallas.

Interest Quotient (Circle One)
High 471 Medium 472 Low 473

Another insured UPS* delivery by NOVA



Nova does it again . . . delivering a constant 2KVA or 3KVA uninterruptible supply of power (UPS) for any of your critical applications. The new "Mintaur" UPS is generally installed between the utility power source and the equipment that is to be protected. This UPS unit not only assures that vital equipment and systems never lose their source of AC power, but also assures that poor quality commercial power is converted into a continuous source of clean power. Typical application areas include data processing, process control, telephony, P.O.S. terminals, health care and banking.

Some outstanding features include:

- Compact size - 14" x 19" x 21"
- Ability to start loads up to 10x rating
- Internal solid state (1/4 cycle) transfer switch
- Systems available at 220V, 50Hz
- Delivery from stock
- Other systems to 50KVA, 1φ and 3φ
- GSA schedule GS-00F-70485



For additional information, call or write:

NOVA ELECTRIC MANUFACTURING COMPANY INC.
A subsidiary of Power Systems Group, Hobart Brothers Company
263 Hillside Avenue, Nutley, New Jersey 07110
(201) 661-3434 • Telex: 219-077

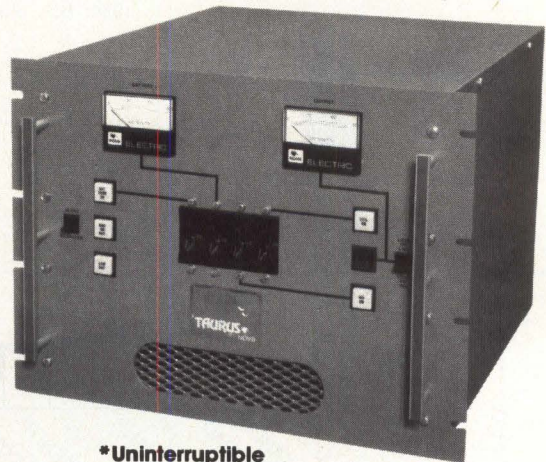

***Uninterruptible
Power System**

CIRCLE NO. 67 ON INQUIRY CARD

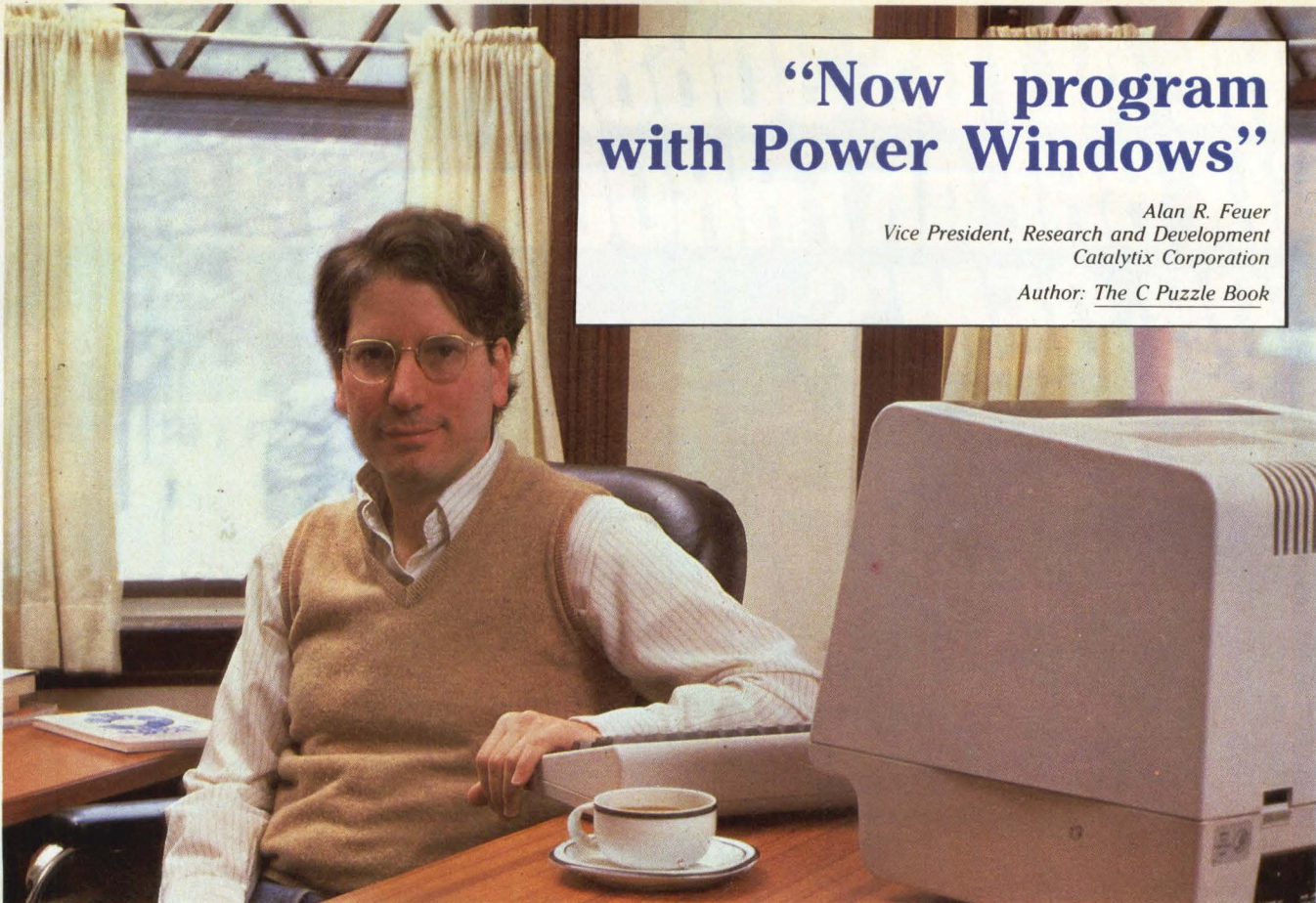

“Now I program with Power Windows”

Alan R. Feuer
Vice President, Research and Development
Catalytix Corporation

Author: *The C Puzzle Book*

CCA EMACS... The Most Powerful Editor Environment Available for Unix and VAX/VMS

“Programming with CCA EMACS, I can look at two or more files at once in different windows and then move text between them.”

Alan Feuer is just one of many demanding programmers who have discovered that CCA EMACS™ makes program editing and system development much easier and faster. And “power windows” are only part of the reason Alan Feuer uses CCA EMACS...

Unprecedented power, speed, functionality, extensibility, pliability, and consistency across systems and on any terminal are others. CCA EMACS includes close to 400 built-in commands which let you do any job with only a few keystrokes, even the kinds of things that are difficult or impossible with other editors. And with our full Common Lisp-based extension language, Elisp™, you can customize CCA EMACS to meet all your specific program needs.

CCA EMACS has two extensive recovery facilities to protect against system failures. Supported by a full online documentation package, including tutorial, the system can be used by beginners and experts alike.

This complete kit of editing tools runs under Berkeley Unix™ (4.1BSD and 4.2BSD), Bell Unix (Systems III and V), Xenix™, and VAX/VMS™. Binary prices range from \$380 to \$850 for Unix to \$1900 for VMS.

CCA Uniworks, Inc.

Productivity Tools for Programmers

20 William Street, Wellesley MA 02181

For more information or to place an order call our customer representatives at

800-222-0214

in MA (617) 235-2600
or mail this request form today.

Please send me information on:

- CCA EMACS The Safe C Development Tools
 AI Development Tools Your complete line of state-of-the-art programming tools

Please send license forms

Name _____

Title _____

Company _____

Address _____

City, State, Zip _____

Phone (____) _____

CCA UNIWORKS, INC.

20 William Street Wellesley, MA 02181

 A Crowntek Company

Unix, VAX and VMS and Xenix are trademarks of Bell Laboratories, Digital Equipment Corporation, and Microsoft Corporation, respectively. Safe C is a trademark of Catalytix Corporation. CCA EMACS and Elisp are trademarks of CCA Uniworks, Inc. **MM685**

THE ALTOS 3068, SIX BREAKTHROUGHS IN ONE FOR OEM'S.

CPU BOARD

32-bit MC68020 microprocessor running at 1.5 MIPS with no wait states; 8 Kb high speed cache memory; up to 16 MB virtual address space per program; optional floating point processor.

FILE PROCESSOR SUBSYSTEM

Controls 4 DMA channels for disk, tape, floppy, and parallel printer port; overlapped seeks on up to 3 disks.

RAM BOARD

Can be configured to OEM needs, up to 16MB using 1MB, 2MB, & 4MB boards.

BREAKTHROUGH PRICE/PERFORMANCE

Combining the 32-bit MC68020, multiple auxiliary processors, and a tuned version of UNIX™ System V, the 30-user 3068 "is capable of a performance that rivals large mini-computers." (Computerworld, April 1985). And it does it for a micro computer price - from \$7,000 for OEM quantities.

BREAKTHROUGH MODULARITY

"Using plug-in boards the way a personal computer does really sets Altos apart." (research firm Creative Strategies, Computerworld, April 1985). OEM's can choose from a wide range of modules: 10 to 40 serial ports; 1 to 16 MB of memory; 17 to 200 MB (formatted) hard disk storage.

BREAKTHROUGH HARDWARE DESIGN

"Altos is way ahead of everybody else." (Creative Strategies, Computerworld, April 1985): high speed 8 KB cache maximizes CPU speed, with no wait states; cache is simultaneously shared between many processors; high performance memory management supports demand paged virtual memory; on-board microprocessors handle all I/O processing.

SERIAL COMMUNICATION BOARD

8 MHz 8086 with 10 serial ports; 32 KB RAM on standard board supports Async. and LAN; 128 KB of additional RAM to support X.25, SNA or custom protocols.

STREAMING TAPE

60 MB, 90 IPS cartridge tape drive.

1.2 MB FLOPPY DISK DRIVE

HARD DISK

Expandable to over 200 MB (formatted) using up to three 17, 33, or 68 MB drives, each with its own power supply.

EXPANSION BOARD SLOTS

Up to three field installable boards can be added for more users or memory.

BREAKTHROUGH UNIX™ SUPPORT

To meet the most rigorous applications requirements, the 3068 incorporates demand paged virtual memory, record locking, and sophisticated interprocess communication. An optimizing C compiler, symbolic debugger, and a full set of development tools and languages form a complete development environment. Productivity tools include an integrated package of word processing, spreadsheet, DBM, graphics, and electronic mail.

UNIX is a trademark of Bell Labs

BREAKTHROUGH COMMUNICATIONS AND NETWORKING

With a variety of protocols and the Altos Worknet™ LAN, 3068 communications span PC's to mainframes. The standard communication board has 10 serial ports, an on-board micro-processor, and up to 128 KB of RAM. The system can be configured with up to four communications boards.

BREAKTHROUGH DIAGNOSTICS

Remote diagnostics minimize downtime by isolating problems to an easily exchanged Field Replaceable Unit.

CIRCLE NO. 69 ON INQUIRY CARD

Get a step ahead of your competition. Put our innovative supermicro engineering to work on your application.

In hardware, software, communications, service, and reliability, Altos has a breakthrough for you.

For more details on the 3068 please call:

1 (800) 538-7872

Inside California:

1 (800) 662-6265

Altos Computer Systems
2641 Orchard Parkway
San Jose, Calif. 95134



COMPUTER SYSTEMS

WORLD LEADER IN
MULTI-USER MICROSYSTEMS

You can't build tomorrow's systems with yesterday's drives.

You've seen one small disk drive, you've seen them all, right? Not exactly. One disk drive stands above all the rest.

It comes from Maxtor.

The company that refuses to produce disk drives merely as good as everybody else. Instead, we set new standards by producing the only 5¼" disk drives worthy of the next generation of supermicros. Winchester with 65 to 380 megabytes of storage. And average access times of less than 30 msec.

And we don't mean prototypes. We mean full production. So, you can build the systems of tomorrow, today. And that can be a big advantage.

For you. Or your competition.

Maxtor Corporation, 150 River Oaks Parkway,
San Jose, California 95134,
(408) 942-1700, TELEX: 171074.
Eastern Regional Sales Office:
(617) 872-8556.
Southwest Regional Sales Office:
(714) 859-3100.

Maxtor

CIRCLE NO. 70 ON INQUIRY CARD



IBM SPURS HIGH-END TAPE DRIVE MARKET

The tape drive market is shifting from large reel-to-reel units toward compact, high-performance cartridge-based drives. IBM may bring order to the 1/2-inch tape-cartridge chaos

Raymond C. Freeman Jr.
Freeman Associates Inc.

The market for removable tape storage—used primarily for Winchester backup—is undergoing a transition from conventional reels to tape cartridges. Quarter-inch tape-cartridge drives now command the low end of the market. IBM Corp. is aiming at the high end with its long-awaited 3480 1/2-inch tape-cartridge subsystem. OEM manufacturers are battling for the middle ground, using IBM's cartridge in smaller, lower cost machines.

The 1/4-inch tape-cartridge industry has been the early leader in building market demand for tape-cartridge drives. These manufacturers have been working together for nearly three years to define product standards. The Working Group for Quarter-Inch Cartridge Drive Compatibility (QIC) has spearheaded this effort. Formed in June 1982, QIC now has 15 member companies representing drive, media and controller manufacturers in the United States and Europe.

QIC's initial accomplishment was to specify a product class with capacities of 20M or 45M bytes. This class, popularly known as "QIC-24," after the recording format used, has risen to the 60M-byte capacity level through the use of the DC600 type of cartridge and its greater tape length. Paired with its companion interfaces, the intelligent QIC-02 and the basic-level QIC-36, QIC-24 machines are now widely supported by controller manufacturers.

As a result of the QIC efforts, standardized

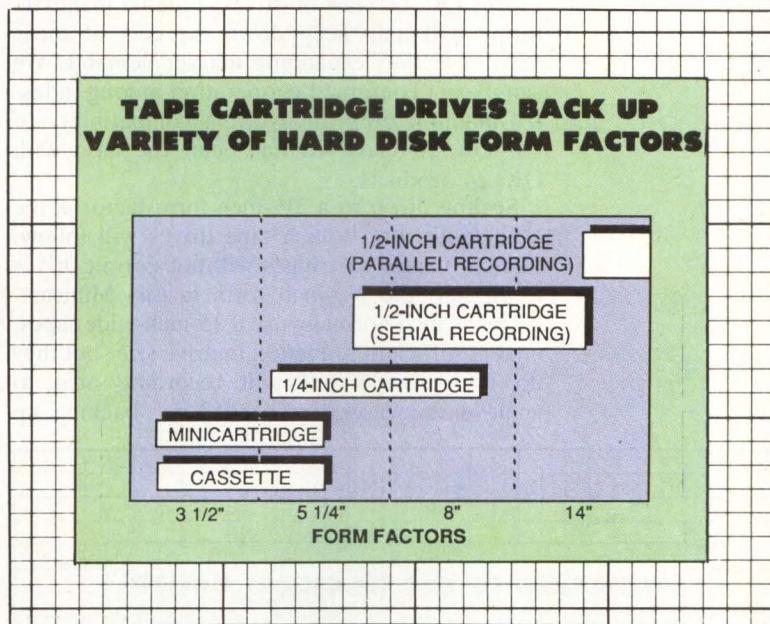

drives and controllers are available from various sources. Standardization has reduced the market risks involved in opting for 1/4-inch drives, simplified integration and helped bring down prices. In both form factor and capacity, 1/4-inch drives are well-suited for backing up and offloading 5 1/4-inch and low-end 8-inch fixed disk drives. For these reasons, the market has embraced 1/4-inch tape drives as a mainstream product class.

With the 60M-byte QIC-24 class now better established, manufacturers are turning their at-

STATE-OF-THE-MARKET REPORT: TAPE DRIVES

The 1/4-inch tape-cartridge industry has been the early leader in building market demand for tape-cartridge drives.

attention to future product requirements. QIC has laid the groundwork for moves in two directions. Higher capacity drives are sure to follow the QIC-24 class. A QIC-50 recording format, now developing as a standard, defines a 120M-byte product class, using an enhanced cartridge dubbed the DC600XTD. This next drive class will enable 1/4-inch products, as they increase in capacity, to serve as backup for higher-capacity 5 1/4-inch Winchesters, and will also permit 1/4-inch tape drives to continue serving low-end 8-inch Winchesters. Increased cartridge capacity will assure that a large percentage of data dumps can be done on one media unit.

The QIC-50 class will provide a sensible growth path for users who have established libraries of QIC-24 cartridges. They will still be able to read those cartridges on the new QIC-50 machines when they become available, since backward-read compatibility has been specified by the Working Group.

QIC is also at work to define a standard head for the QIC-50 class of drives. Volume manufacturing will help keep down the cost of these machines, thus expanding market demand. We can expect continued cooperation among industry manufacturers in assuring compatibility of the QIC-50 class, as has been the case with QIC-24 products.

Scaling down to a 3 1/2-inch form factor is the other path that 1/4-inch tape drives will follow. Standard-sized cartridges will not permit drives to fit into the 3 1/2-inch form factor. Minicartridges, which normally use 0.15-inch-wide tapes, enable sufficient reduction in drive size, but they do not provide sufficient recording area to achieve the capacities needed for backing up

tomorrow's disk drives. 3M of St. Paul, Minn., has attacked this limitation by upgrading the minicartridges to a new DC2000 configuration. The DC2000 uses 1/4-inch tape. The DC2000 also uses a longer tape load and incorporates the mechanical improvements developed by 3M for the DC600XTD full-sized cartridge.

A new class of 1/4-inch tape drive based on the DC2000 minicartridge should start moving into the market in 1986. This will provide appropriate capacity and form factor to match up with 20M-byte and larger 3 1/2-inch Winchesters as companies start shipping them in volume. The DC2000 class of drive may also serve some half-height, 5 1/4-inch Winchesters. This new class will not only permit more compact systems but will also reduce the amount of space required to store cartridges.

Competition for the DC2000 class of minicartridge drives will come from the data-cassette drive industry. Several manufacturers of high-performance cassettes and drives, taking their cue from the QIC Group, banded together as the Working Group for Data Cassette Drive Compatibility (D/CAS). They have proposed standards for recording format, drive interface and media for 10M-, 20M- and 45M-byte products. Their drives are compatible with QIC-02/QIC-24 controllers, thus simplifying integration.

3M improves media

3M has responded to increased market demand for 1/4-inch tape-cartridge drives by committing itself to their future improvement. 3M is developing higher performance coatings with fewer defects, improving tape tracking and reducing instantaneous speed variation. These cartridge improvements will support the advances being planned for future cartridge drives.

Availability of cartridges is also improving. 3M, which invented the 1/4-inch tape cartridge, still dominates the market and enjoys technological leadership. Data Electronics Inc. (DEI), the other current supplier of 1/4-inch tape cartridges, is now past its market-entry phase and is expanding its production capabilities. DEI offers innovative variations on standard cartridges and will offer a broad line of both full-sized cartridges and minicartridges. Cartrex Corp. has received venture funding and is developing a manufacturing facility for production of a modified 1/4-inch tape cartridge said to be compatible with the standard cartridge.

In addition to mainstream standards, several manufacturers also offer innovative variations on 1/4-inch drives to meet differing market requirements. Northern Telecom Inc. and Qantex

MEMBERS OF QIC WORKING GROUP

Adaptive Data Systems Inc.	Perex Ltd.
Alloy Computer Products Inc.	Qantex Corp.
Archive Corp.	Tandberg Data A/S Inc.
Cipher Data Products Inc.	Tallgrass Technologies Corp.
Data Electronics Inc.	3M Co.
Irwin Magnetic Systems Inc.	Wangtek Inc.
Kennedy Co.	Western Digital Corp.
Northern Telecom Inc.	

IN JULY THE INFORMATION WORLD WILL BE IN CHICAGO.

The 1985 National Computer Conference, July 15-18, Chicago, Illinois

Where Will You Be?

In today's highly-competitive world, everyone needs an edge. And in today's highly-electronic world, that edge is often the most up-to-date information technology.

That's why both computer specialists and business professionals will be at the 1985 National Computer Conference. Where tomorrow's technology is happening today. You'll find:

- The latest developments in hardware, software and services, focusing on applications.
- Over 700 major exhibitors showcasing the latest developments in the industry.
- 84 Technical Sessions on subjects such as Artificial Intelligence, Personal Computing and Networking.
- 27 Professional Development Seminars dealing with specific areas like Data Communications, Human Resource Management and Voice Processing.
- A Keynote Address, "Managing the Creation and Commercialization of Technology," given by Admiral B.R. (Bobby) Inman, President and CEO of Microelectronics & Computer Technology Corporation of Austin, Texas.

- Pioneer Day honoring the contributions of Argonne National Laboratory, Oak Ridge National Laboratory and the University of Illinois.
- And more!

Call 800-NCC-1985

To register or find out more details call 800-NCC-1985, or mail in this coupon today. NCC '85—We put you on top with today's Information Technology.



1985 National Computer Conference Technology's Expanding Horizons

- Yes!** I want to attend NCC '85! Please send me a registration form today!

Name _____
Title _____
Company _____
Address _____
City _____ State _____ Zip _____

- If you would like information about exhibiting at NCC '85, please check here.

Mail to: NCC '85 • 1899 Preston White Dr. • Reston, VA 22091

OR CALL TOLL-FREE 800-NCC-1985 AND REGISTER TODAY! Visa, MasterCard and American Express accepted. Register early and save \$25!

QUALITY AND INNOVATIVE TECHNOLOGY CAN WORK TOGETHER.

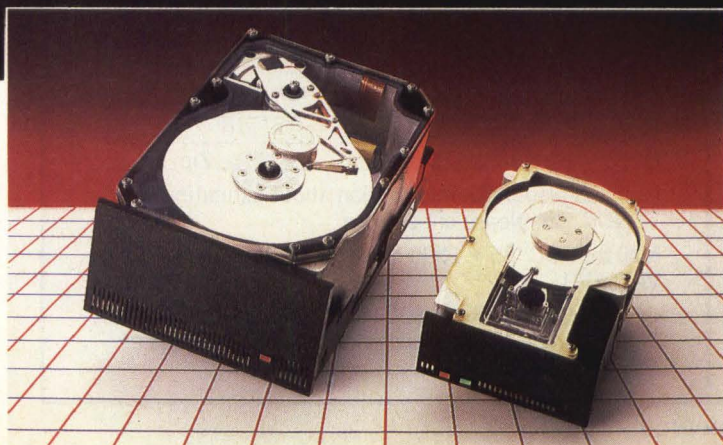
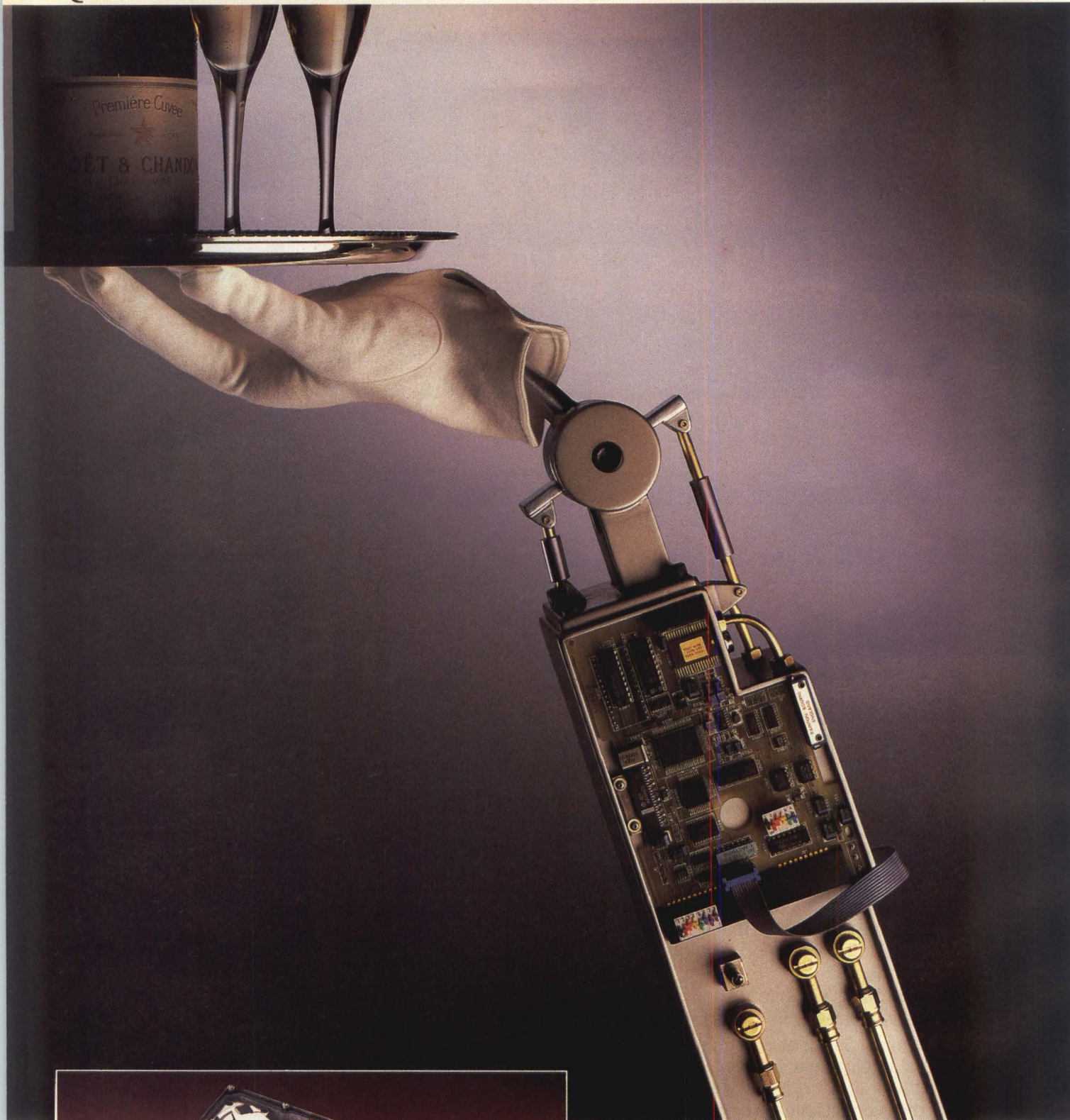

AS A COMPETITIVE OEM MANUFACTURER, YOU DEMAND EVEN HIGHER STANDARDS OF QUALITY AND INNOVATIVE TECHNOLOGY FROM YOUR EQUIPMENT SUPPLIERS.

NEWBURY DATA CAN MEET THAT DEMAND WITH A RANGE OF 5¼" AND 3½" DISK DRIVES THAT PROVIDE UNMATCHED STORAGE CAPACITY.

CLOSED LOOP VOICE COIL TECHNOLOGY GUARANTEES FAST ACCESS TIMES, WHILST ALL DRIVES ARE FITTED WITH INDUSTRY STANDARD INTERFACES: EITHER ST 506/412 OR THE NEW ENHANCED SMALL DEVICE INTERFACE (ESDI).

AND ALL BACKED BY THE KIND OF SERVICE AND SUPPORT YOU'D EXPECT FROM NEWBURY DATA, EUROPE'S LEADING PERIPHERALS MANUFACTURER.

SO IF YOU'RE THINKING OF DISK DRIVES, REMEMBER WE'VE BEEN PROVIDING 'HI-TECH' SOLUTIONS TO 'HI-TECH' PROBLEMS FOR NEARLY 30 YEARS.

Newbury Data
A member of the DRI Group

Plugging the world into peripherals

LEN KEHOE, 20, VERNON STREET, NORWOOD, MASSACHUSETTS 02062. TELEPHONE: 617 551 0280

STATE-OF-THE-MARKET REPORT: TAPE DRIVES

Corp. were first to tackle the 100M-byte capacity level. Tallgrass Technologies Corp., selling through retail channels, has achieved success with drives using its proprietary PC/T recording format. Other non-standard products are also offered as alternatives, including single-reel cartridge drives from Interdyne Co.

IBM shakes up 1/2-inch world

In the high-capacity (over 100M-byte) tape drive market, a demand for smaller, lower cost tape drives disrupted the 1/2-inch reel-to-reel world. The demand was reinforced by long-standing rumors that an announcement of such a drive by IBM was imminent. Several enterprising companies plunged into this "opportunity" with drives that used 1/2-inch tape and that were designed to fit into 8- and 5 1/4-inch form factors. Unfortunately, no two drives were compatible or used the same kind of tape cartridges.

The IBM announcement, in March 1984, largely upended these early initiatives. While the IBM 3480 1/2-inch tape-cartridge drive itself is aimed at the high-end market, as a companion for IBM 3380 disk drives, the IBM tape cartridge should quickly become adopted as the media standard for smaller, lower cost OEM drives as well.

Early market forays—by Digital Equipment Corp., Electronic Processors Inc., MegaTape Corp., Rosscomp Corp., Tandon Corp. and Tokyo Electric Co. (TEC)—are unlikely to become mainstream contenders. DEC may ship large quantities of its drive on its own systems, creating a sizable but unique interchange environment. The product is unlikely to appeal to the OEM market, however.

EPI's drive has not yet made it into production volumes. The company's link to Memorex Corp. is now of questionable value, since Memorex has bailed out of the OEM market. And Fujitsu America Inc., EPI's new partner, may not be able to push a non-standard product to widespread acceptance.

MegaTape, with its 330M- and 500M-byte capacities and ready availability of products, can carve out niche markets suited to the characteristics of its products, but growth in such markets will be limited. Rosscomp offers an engagingly simple design in either 5 1/4- or 8-inch form factors, with a variety of popular interfaces. Its offerings will have short-term appeal but will not stave off the inevitable adoption of the IBM tape cartridge as the new 1/2-inch media standard.

Tandon's 1/2-inch tape-cartridge project never made it to market. Its 50M-byte capacity level has now been usurped by the QIC-24 class of

HI/TC TENTATIVE SPECS FOR 1/2-INCH DRIVES	
Capacity (user)	240M bytes
Transfer rate	200bps
Intelligent interface	ADAPTEC, SCSI and/or IPI
Track addressability	yes
Block addressability	yes
Backup file	20 minutes, maximum
Form factor	5 1/4-inch or 8-inch
Head channels	two
Media	IBM tape cartridge or equivalent

1/4-inch drives. TEC's device, at 200M bytes, uses an endless loop of tape on a single reel. Because IBM will set the standard for this capacity range, unique approaches such as TEC's are unlikely to gain significant market penetration.

Standards remain the key

Many companies in the OEM industry have decided to cooperate in defining standards for a new class of 1/2-inch tape-cartridge drives using the IBM tape cartridge or equivalent. Most major manufacturers of 1/2-inch tape are expected to offer cartridges compatible with the IBM product, so the desire for multiple sources will be satisfied.

The Working Group for Half-inch Tape-Cartridge Drive Compatibility (HI/TC) is providing a forum for developing standards for this new OEM product class. Organized last November, the HI/TC group has nearly hammered out an agreement on a recording format, which will probably be based on serpentine recording with two active channels.

Head standards also are being developed by HI/TC to reduce drive cost and improve availability. Definition of one or more device interfaces will follow, so controller developments can move forward.

HI/TC formal members include Archive Corp., Computer Peripherals Inc., Kennedy Co., Perex Ltd., Pertec Peripherals Corp., Storage Technology Corp., Tallgrass Technologies Corp., Telex Computer Products Inc., and Wangtek Inc.

The sword hanging over HI/TC's head is the uncertainty about IBM's and Cipher Data Products Inc.'s intentions in the low-end 1/2-inch market. An announcement was made last fall of

STATE-OF-THE-MARKET REPORT:
TAPE DRIVES

The IBM tape cartridge should quickly become adopted as the media standard for smaller, lower cost OEM drives.

a joint development agreement for several products between IBM and Cipher. It is widely thought that Cipher is at work on small, low-cost, serial-recording drives incorporating the IBM tape cartridge. Such machines would be logical as attack vehicles on the OEM market because of the formidable strength of an IBM-Cipher alliance. If IBM were to adopt such drives for its own systems, a low-end standard would probably be declared in the process. Because of customarily tight lips on both sides of the IBM-Cipher agreement, no one knows what to expect or when to expect it. The HI/TC initiative reflects a determination not to simply wait and find out.

In terms of capacity, low-end 1/2-inch tape-cartridge drives, in whatever form they emerge, will pick up where 1/4-inch drives leave off. Buyers will make their choices depending on capacity, performance, form-factor and interchange requirements.

As these products enter the market, each will play its own role. Minicartridges will serve 3 1/2-inch and low-end 5 1/4-inch requirements, as will

data cassette drives. Full-sized 1/4-inch tape cartridges will address 5 1/4- and 8-inch hard disk needs. OEM 1/2-inch tape-cartridge drives will target high-end 5 1/4-, 8, 10 1/2- and 14-inch applications. High-end 1/2-inch tape-cartridge drives, compatible with IBM's 3480 will be used with top-of-the-line 14-inch disk drives. There will be room for all five product classes. Their expected popularity and the new wave of industry cooperation on standards will support the swing to tape cartridges. □

Raymond C. Freeman Jr., a contributing editor for *Mini-Micro Systems*, is president of Freeman Associates Inc., a Santa Barbara, Calif., data-storage management consulting and publishing company. He is a facilitator and spokesman for the QIC, D/CAS and HI/TC working groups.

Interest Quotient (Circle One)
High 474 Medium 475 Low 476

This Publication is available in Microform.

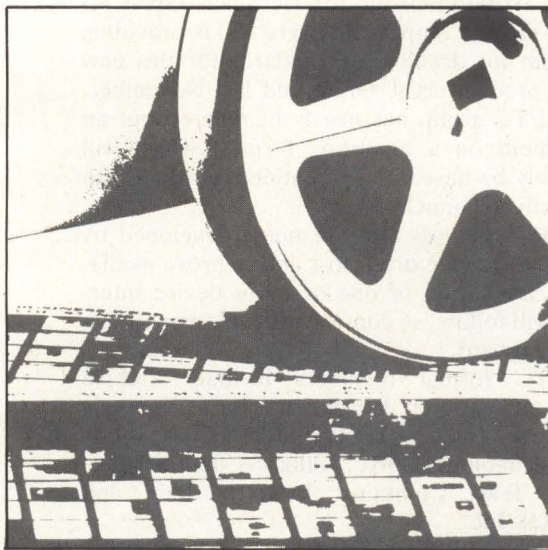

University Microfilms International

Please send additional information

for _____
(name of publication)

Name _____

Institution _____

Street _____

City _____

State _____ Zip _____

300 North Zeeb Road
Dept. P.R.
Ann Arbor, Mi. 48106



Not long ago, *PC Magazine* called MDBS III "The most complete and flexible data base management system available for microcomputers." That's a powerful statement. But then, MDBS III is an amazingly powerful software package. So powerful, in fact, that it lets you build mainframe-quality application systems on your micro or mini. MDBS III is not for beginners. It's for application developers with large data bases or complex data interrelationships who want to define data base structures in the most natural way—without resorting to redundancy or artificial constructs. It's for professionals who can appreciate its extensive data security and integrity features, transaction logging, ad hoc query and report writing capability and its ability to serve multiple simultaneous users. And if you want the power and the glory that only the world's most advanced data management system can provide, MDBS III is for you. For information on MDBS III and our professional consulting services, write or call Micro Data Base Systems, Inc., MDBS/Application Development Products, 85 West Algonquin Road, Suite 400, Arlington Heights, IL 60005. (800) 323-3629, or (312) 981-9200. **MDBS III. ABSOLUTE POWER.**

WE'LL GIVE YOU THE POWER.

YOU TAKE THE GLORY.

COMPAQ could have stopped here



...but we didn't.

Introducing the new COMPAQ DESKPRO 286™ More features, more speed, more power.

Most people think the IBM® Personal Computer-AT™ holds the records for speed, memory, and storage. But now COMPAQ® has created a personal computer that pushes the technology much further.

A faster computer

Most computer companies would have been satisfied with a computer that ran programs as fast as the IBM PC-AT. But not COMPAQ. The new COMPAQ DESKPRO 286 runs all the popular programs 30% faster.

Work alone or network

Most would have been content with 3 Megabytes of memory, the IBM PC-AT's maximum. But again, not COMPAQ. The COMPAQ DESKPRO 286 can expand to 8.2 Megabytes.

And most would have been comfortable with 40 Megabytes of storage, the IBM PC-AT's maximum. But we designed the COMPAQ DESKPRO 286 to expand up to 70 Megabytes so it can become a faster, more powerful network file server.

Like the IBM PC-AT, COMPAQ offers 360-K byte and high-capacity 1.2-Megabyte diskette drives. But

we didn't stop there. We offer you more. Like the *internal* fixed disk drive back-up system pioneered by COMPAQ, to protect all the data on your 20-, 30-, or 70-Megabyte fixed disk drive system. There's room to accommodate up to four storage devices.

No compromises

The COMPAQ DESKPRO 286 offers a monitor that displays both high-resolution text *and* graphics. To get the same feature with the IBM PC-AT, you'd have to pay considerably more.

In short, with the COMPAQ DESKPRO 286, you don't get compromises. Just a more powerful, more advanced, more complete personal computer for anyone who demands the utmost in performance.

And if you need all this power to go, we also offer it in a package half the size of an IBM PC-AT, complete with a handle. It's called the COMPAQ PORTABLE 286™.

Portable or desktop, COMPAQ offers computers without equal. Because we design them without compromise.

For a free brochure or the location of your nearest Authorized COMPAQ Computer Dealer, call toll-free 1-800-231-0900 and ask for operator 7.



It simply works better.

COMPAQ
DESKPRO 286™



OEMs... Is Your Input Strategy As Sound As Your CPU Strategy?



Computer users are demanding additional input devices from you. Key Tronic can help you meet the demand for these input devices, and minimize your development costs.

Key Tronic is integrating the most popular input devices into OEM keyboards. All processing is done in the keyboard and no additional system ports are required . . . using existing electronics saves money. Also, all input can be presented as a series

of key presses to assure compatibility with existing and future software.

Speech Recognition, Touch Pad, Mouse, Bar Code and Joy Disk are available to enhance your product with unique, value added benefits. Distinguish your product from the ordinary! Talk to your Key Tronic representative today.

A. Joy Disk — Four keys in one; rapid cursor control.

B. Touch Pad — Multi-purpose input device; programmable key pad, cursor control, drawing tablet.

C. Speech Recognition — Natural, language independent command entry. Hands free operation.

D. Mouse — Popular pointing and selecting tool.

E. Bar Code — Fast, accurate data capture.

“Feel the Key Tronic Touch”

key tronic

The Responsive Input Company

P.O. Box 14687 • Spokane, WA 99214 • USA
(509) 928-8000 • TWX 510-773-1885

CIRCLE NO. 74 ON INQUIRY CARD

VAR CHANNEL SKIRTS RETAIL LOGJAM

A niche marketing strategy through VARs provides an alternative to battling for retail shelf space

Evan Moltz

International Data Corp.

The microcomputer industry faces a predicament. Simply put, the retail channel cannot support the multitude of microcomputer vendors. Too many manufacturers are vying for shelf space in the major retail chains, such as ComputerLand, Businessland Inc., Entré Computer Center and Sears Business Systems Center, differentiating their products only by price. Nor is the retail channel sophisticated enough to sell multiuser or networked systems. And manufacturers cannot afford to be continually squeezed on margins by keeping up with IBM Corp.'s price cuts.

Developing a niche marketing strategy to satisfy the needs of a specific, targeted market is one possible solution. The value-added reseller is the primary distributor in these niche markets, providing manufacturers access to markets currently untapped by traditional retailers.

Because most VARs are well-established in the vertical markets they address (73 percent have been in business for three or more years), they provide manufacturers a specific industry-area access. VARs are specialists, offering a high level of professionalism, particularly with multiuser and networked products. The VAR channel's value-added focus makes it less susceptible to margin erosion than is the retail channel.

Unfortunately, there is no industry-wide definition of a VAR. Generally, the term refers to a sales organization that is not classified as retail and that in some way adds value. A possible reason for any misuse of the acronym may be that VARs have been perceived as occupying a higher level of distribution than retailers, leading

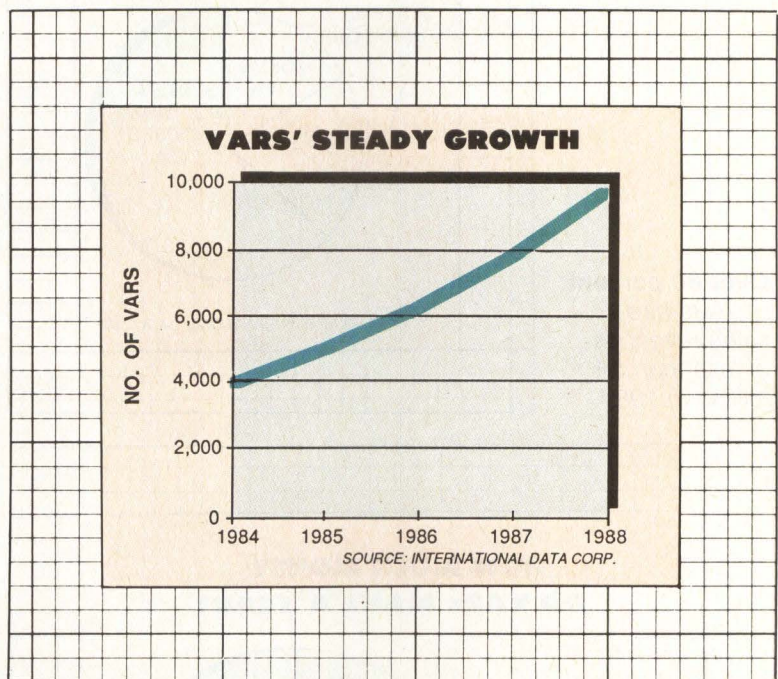

many non-VARs to appropriate the label.

As a result, "VAR" has become an umbrella term that now includes the traditional categories of computer resellers. In an effort to clarify, market research company International Data Corp. (IDC) defines a VAR as a non-retail organization that buys products from a manufacturer, adds tangible or intangible value and resells the products to the next tier of distribution or to the end user. (Tangible value can be in the form of either hardware or software; intangible value can be service, support, training or expertise in the given market niche.) What's actually added varies, depending on the size and type of the system, the level of integration

The number of VARs is expected to rise roughly 25 percent per year through 1988, with system integrators seeing the most growth.

STATE-OF-THE-MARKET REPORT: VALUE-ADDED RESELLER MARKET

provided and the end-user application.

The following categories of resellers fall under IDC's definition of a VAR:

- System integrators buy hardware from one vendor and software from another and customize the hardware and software to form a turnkey system, usually adding a front-end or forms generator, thus providing an integrated, turnkey small-business system.

- OEMs integrate a manufacturer's hardware with their own hardware and software and resell the package with a substantively unique identity.

- System houses develop their own software, buy hardware from a vendor and sell a complete solution.

Not all VARs fit neatly into one category, and VARs often have characteristics of several categories.

VARs comprise 63 percent system houses, 21 percent system integrators and 16 percent OEMs. The number of VARs is increasing at a rate of 25 percent per year. The number of system integrators is growing the fastest and is expected to be 2½ times larger than its current size by 1988.

Most VARs locate in areas close to manufacturers in order to share in the local technology base. This enables VARs to establish a closer relationship with primary suppliers. Of the VARs listed in IDC's VAR File, the largest concentration, 795, is in California. When these VARs are combined with those in the next four most VAR-populated states—New York, Massachusetts, Texas and New Jersey—they account for nearly half of all U.S. VARs.

Sixty-one percent of VARs sell to more than one vertical market but usually in the same application area (30 percent of all applications sold by VARs are accounting programs). Manufacturing, medical, banking, government and distribution are the top five vertical markets. These five represent 70 percent of the vertical markets targeted by VARs.

Of nearly 4,000 VARs surveyed, almost half had sales revenues of less than \$1 million. Because most VARs have low sales revenues (the average VAR moves 20 to 25 systems per year), it's costly for manufacturers to support them. As a result, 65 percent of the VARs that sell personal or supermicrocomputers to the end user buy their products from distributors.

Unfortunately, the VAR market may not be a panacea for manufacturers' distribution problems. In fact, many manufacturers will find this channel as difficult to penetrate as retail, because VARs are very selective. Vendors wanting to recruit VARs must realize that they can no longer dictate terms to VARs and just sell them hardware. They also must offer VARs the support necessary to sell their systems. □

More than half of all VARs are system/software houses.

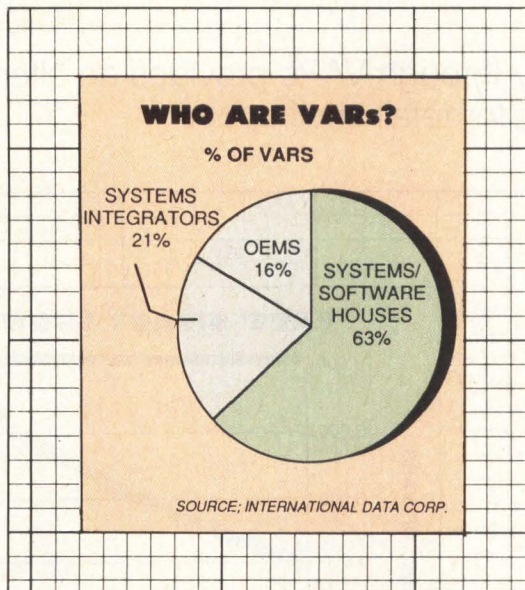

Over 80 percent of VARs had sales revenues of less than \$5 million in 1984.

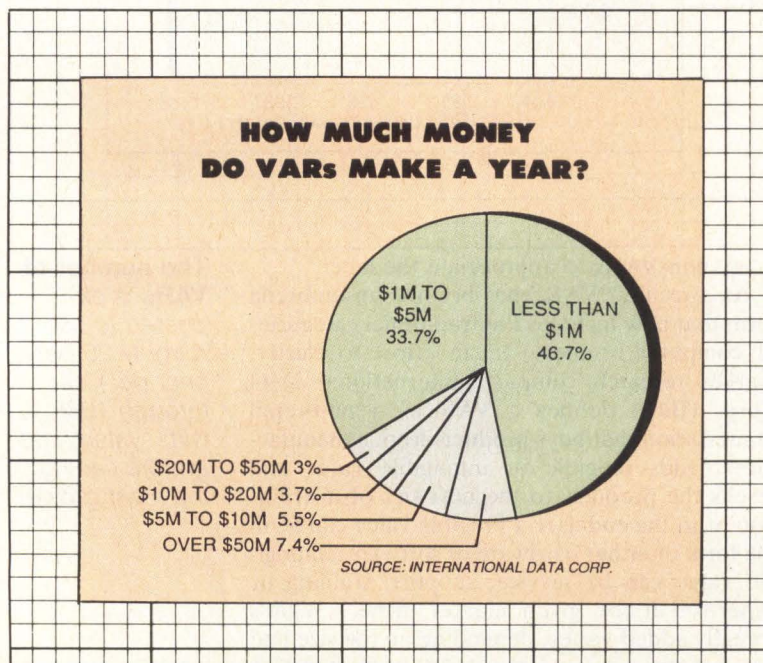

Evan Moltz is director of microservices at International Data Corp., Framingham, Mass., a market research and consulting company for the information-processing industry.

Interest Quotient (Circle One)
High 477 Medium 478 Low 479

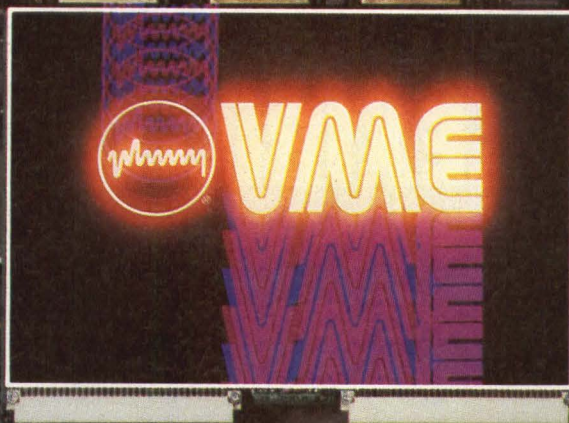

THE PEOPLE WHO GIVE VMEbus WHAT IT NEEDS MOST, GIVE YOU THE MOST VMEbus MEMORIES. PLESSEY.

Plessey Microsystems makes life easy for the VMEbus designer with the most comprehensive range of VME memories in the world. All backed by Plessey's worldwide resources, technical support services and total corporate commitment to VMEbus.

Plessey VME Memories for your systems. The Plessey VME memory range includes every popular memory technology, including DRAM, ROM/EPROM and fast static RAM. As shown in the accompanying table, our capacity range spans 128 Kbytes to 3 Mbytes with EDC and 4 Mbytes with parity DRAM. Plessey VME memories are available with full 32 bit support to take advantage of the MC68020 and NS32032. So, no matter what VME route you're taking, there's a Plessey memory to take you there better.

PLESSEY VMEBUS MEMORIES						
Maximum Capacity	Plessey Memory	Parity	EDC	Data Bits	Write Access nS	Read Access nS
4 Mbyte DRAM*	PME 2EP	•		8/16/32	150	270
3 Mbyte DRAM*	PME 1EA		•	8/16/32	150	300
2 Mbyte DRAM	PME 048D	•		8/16	190	300
1 Mbyte DRAM*	PME 512EP	•		8/16/32	150	270
3/4 Mbyte DRAM	PME 256EA		•	8/16/32	150	300
512 Kbyte DRAM	PME 012D	•		8/16	190	300
512 Kbyte EPROM or ROM; 128 Kbytes SRAM	PME CRR-1†			8/16	User Adjustable	
128 Kbytes SRAM	PME 128S†			8/16	140	140

* with optional daughter board
† on-board battery backup

Plessey VME: a continuing commitment. Plessey VME memories are just a part of the rapidly expanding range of Plessey VMEbus board level products which also includes single board computers; controllers, graphics and I/O boards; backplanes; power supplies; software and firmware, including

languages, operating systems and drivers; and of course that famed Plessey guarantee and backup. With even more Plessey VME on the way.

For details on Plessey VME memories or our other VMEbus products and capabilities, call or write Plessey Microsystems, One Blue Hill Plaza, Pearl River, NY 10965. (914) 735-4661 or toll-free (800) 368-2738. Or use the coupon below.

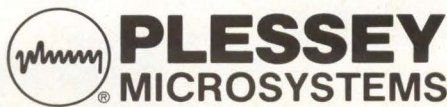

CIRCLE NO. 75 ON INQUIRY CARD

For additional information, clip and mail to Plessey Microsystems, One Blue Hill Plaza, Pearl River, NY 10965.

Name _____ Title _____
Company _____
Address _____
City _____ State _____ Phone _____
Zip _____

**EMULEX HAS
THE CORNERSTONE
FOR SYSTEM BUILDING
FLEXIBILITY.**

SCSI

EX
EMULEX

AND, WE'VE GOT ALL THE OTHER BUILDING BLOCKS, TOO.

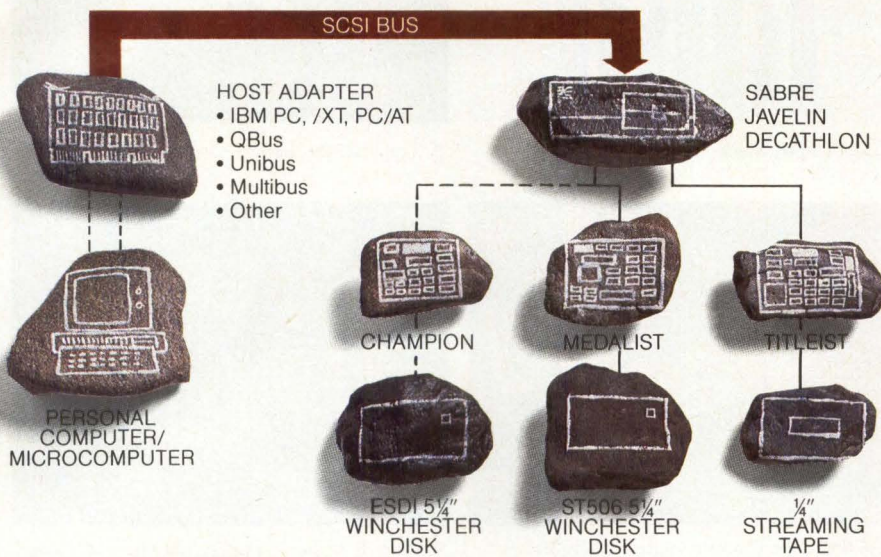

THE SCSI POTENTIAL. THERE'S PLENTY OF IT. SCSI allows you system building ease and maximum flexibility through the use of a common I/O bus and standard peripheral interface. All Emulex/SCSI-based products feature these enhancement benefits.

FEATURE	BENEFIT
Arbitration	Permits concurrent I/O operations between different devices by prioritizing bus usage.
Disconnect/Reselect	Maximizes bus utilization by providing devices an orderly scheme to release and regain bus control.
Copy	Permits data transfer between devices without host intervention.
Search Data	Used to search one or more logical blocks for less than, greater than or equal to a specified data pattern.
Reserve/Release	Device can be reserved for exclusive use by a single host in multiple host configuration.
High Level Command Set	Provides host with device independence for a given type of device.

With Emulex's SCSI products as the cornerstone for your mini/micro computer systems, you can continue to build on your investment. Our SCSI-based products offer you convenient building blocks with which to assemble, update, mix or interchange different types of peripheral storage devices to your computer system. Couple that with the industry's widest range of advanced products and you have the single best source for your system building needs. Products with performance, quality and reliability that's unsurpassed.

PUT MORE INTO YOUR SYSTEMS WITH EMULEX/SCSI MICRO SUBSYSTEMS.

Compact, versatile Emulex/SCSI micro subsystems provide you a variety of cost-effective storage and backup devices. Choose the enclosure you desire—desktop, rack or tower—disk size—36, 67 or 110 MB formatted capacity—and the type of backup most meaningful to your application. Top that off with the ability to interface virtually any CPU type and you have a powerful and complete storage solution.

SABRE, combines on-line storage and file backup capability in a compact unit housing a 5 1/4" Winchester disk drive and an 8" removable cartridge disk.

Javelin, an extremely versatile storage system designed to satisfy

a wide range of OEM and end user applications. Space accommodations for two SCSI peripherals, either one 5 1/4" disk drive and one 60 MB 1/4" cartridge tape streamer, or two disks.

Decathlon, available in a rack mount or an attractive tower/pedestal model, contains up to three 5 1/4" peripherals, with a choice of Winchester disks and a 60 MB 1/4" streaming tape drive.

EMULEX'S HOST ADAPTERS CAN FIT SCSI INTO YOUR PLANS.

Emulex/SCSI host adapters are available for QBus and Unibus systems, IEEE 796 Multibus systems, the IBM PC/XT and PC/AT and compatibles. We've designed these host adapters to take full advantage of the versatility and high performance of the SCSI.

GET MORE INTO YOUR SYSTEMS WITH EMULEX/SCSI CONTROLLERS.

Our Medalist and Champion SCSI controllers can interface any ST506 or ESDI 5 1/4" Winchester disk drive. And our Titleist can interface most 1/4" streaming tape drives.

EMULEX CAN FIT SCSI INTO YOUR PLANS.

If you're looking for a solid cornerstone and the widest range of building blocks to put together powerful and efficient mini/micro subsystems, then talk to Emulex.

For detailed information on Emulex/SCSI products, call toll free (800) 854-7112. In California (714) 662-5600. Or write: Emulex Corporation, 3545 Harbor Blvd., P.O. Box 6725, Costa Mesa, CA 92626.

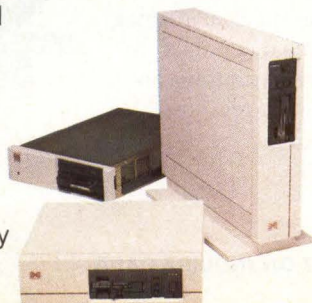

Yes! Please send me your new **Micro Products Handbook**.

My needs are: Immediate 60-120 days Info. only

Have Salesman call Quantity per year: _____

Specify Computer/Peripherals in use or planned:

DEC _____ Multibus _____

IBM _____ Other _____

Name _____

Title _____ Phone _____

Company _____

Address _____

City _____ State _____ Zip _____

MM



CIRCLE NO. 76 ON INQUIRY CARD

IBM PC, XT, AT are registered trademarks of International Business Machines Corporation. QBus and Unibus are registered trademarks of Digital Equipment Corporation.

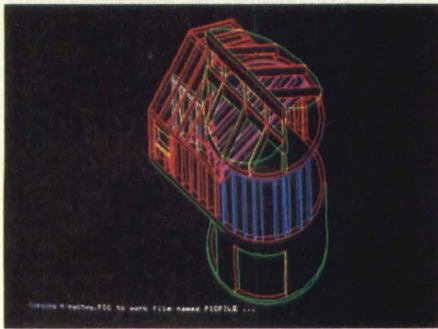

1. High Speed (MicroCAD Software)

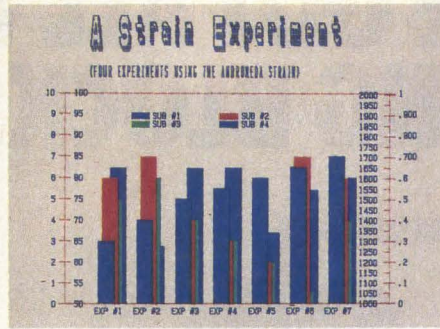

2. Dual Display Modes (Energraphics Software)

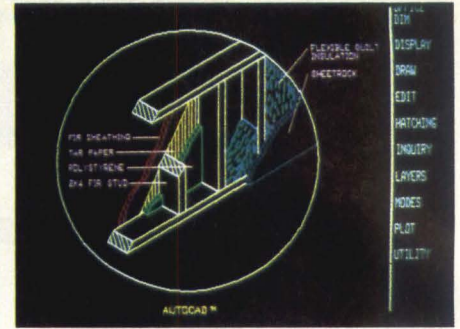

3. Simplified Processing (AutoCAD Software)

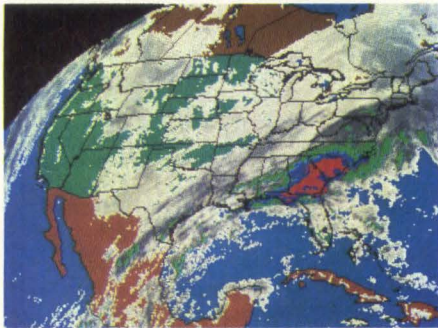

4. 9 Bit Planes (Courtesy WSI Inc., Bedford, MA)

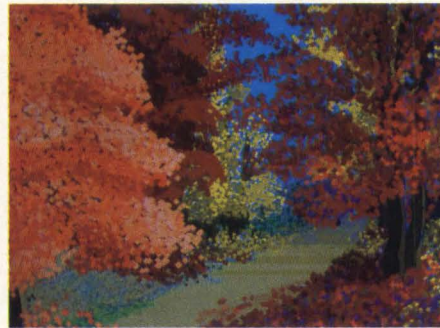

5. 16.8M Color Shades (Courtesy Catherine Del Tito, Wave Graphics)

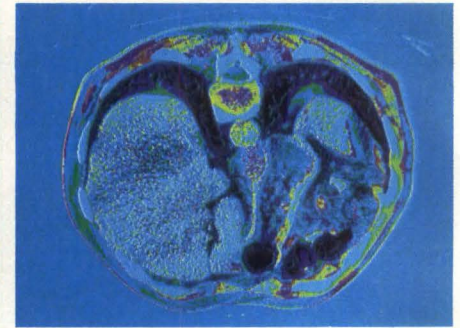

6. High Resolution (Courtesy University of North Carolina at Chapel Hill, Depts of Computer Science and Radiology)

Six reasons why professionals continue to choose Vectrix for quality IBM XT/PC graphics.

Even though IBM offers a color graphics card, professionals still choose Vectrix. It's not surprising. Especially once they've seen us in action. Professionals know that our VX/PC Board Set delivers the quality and performance they need for serious color graphics.

The VX/PC Board Set provides advanced features that help simplify sophisticated graphics design. Besides displaying 512 simultaneous colors from a palette of 16.8 million, the VX/PC supports an extensive library of on-board graphics macros for ease of programming and fast design, as well as full emulation of the IBM color card. And, an on-board 16-bit micro-

processor frees your computer to concentrate on other tasks.

But that's not all. Our 9 bit planes

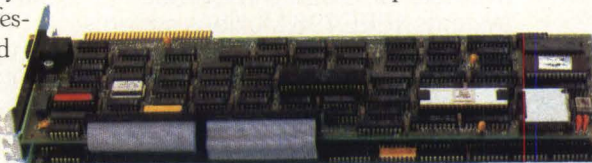

add an extra dimension of sharpness and clarity to your image that must really be seen to be appreciated. That's why it's not surprising to see Vectrix color cards in applications such as medical imaging, weather satellite data mapping, computer aided design and drafting, and graphics arts, to name a few.

What you will find most surprising, however, is the price. Our VX/PC Board Set was designed with the OEM in mind. So when comparing the performance of Vectrix with the competition, check the price too. You'll like what you see. For more information, contact Vectrix Corporation, 2606 Branchwood Drive, Greensboro, North Carolina 27408. Phone (919) 288-0520. Telex 574417.



Distributor inquiries welcome.

IBM XT, IBM AT, and IBM PC are trademarks of International Business Machines Corporation, White Plains, NY.
 MicroCAD is a trademark of Imagimedia Technologies, Inc., San Francisco, CA.
 AutoCAD is a trademark of AutoDesk, Inc., Sausalito, CA.
 EnerGraphics is a trademark of Enertronics Research, Inc., St. Louis, MO.

CIRCLE NO. 77 ON INQUIRY CARD

NCC PANELS STRESS INTERNATIONAL OUTLOOK

From The Windy City to the world:
The annual NCC conference offers more than 80 technical sessions
on AI, networks and architectures

Lynn Haber, Associate Editor

The broadening international scope of computer technology and the impact of denser circuitry, non-traditional architecture, increasingly diverse software and communications will be key topics at this year's National Computer Conference (NCC) scheduled for July 15 to 18 at Chicago's McCormick Place.

Retired U.S. Navy Adm. B.R. Inman, chairman, president and chief executive officer of Microelectronics and Computer Technology Corp., a research development venture in Austin, Texas, will deliver the keynote address, entitled "Managing the Creation and Commercialization of Technology."

"This is increasingly going to be an interna-

tional marketplace," says Inman. "The industry will need to take new approaches in order to effectively penetrate the markets opening up abroad."

Inman points out that the National Academy of Sciences identifies telecommunications, microelectronics, aerospace, materials, energy and biotechnology as six areas of emerging technology. Inman will discuss the creation of capital to take advantage of these technologies, as well as the speed with which technology moves from the laboratory to the marketplace.

The conference program will include more than 80 technical sessions addressing "Technology's Expanding Horizons," the conference theme. Program topics include "Artificial Intelligence," "Networking," "Personal Computing,"



Chicago's McCormick Place will host the 1985 National Computer Conference from July 15 to 18.



As the NCC keynote speaker, Adm. B. R. Inman will speak on creating and commercializing technology.

"Information Systems Management," "Software Systems" and "Future Architectures and Supercomputing."

In addition to exhibits by more than 700 manufacturers and the conference program itself, NCC will also feature 27 sessions labeled as Professional Development Seminars. According to Robert Gershon, seminar chairman, the sessions will offer in-depth discussions on critical areas of high-technology.

Topics include: "Fault-Tolerant Systems" by Omri Serlin of the ITOM International Co., "DP and CAD/CAM: Where's the Fit?" by Joel N. Orr of the CAD/CAM Institute, and "Artificial Intelligence: Vision, Brain and Robotics" and "Artificial Intelligence: Expert Systems and Natural Language Processing," both by professor Michael Arbib of the department of computer and information science at the University of Massachusetts at Amherst.

Another seminar will deal with the rise of the 32-bit standard microprocessor, which has resulted in a new generation of products. John Payne, director of strategic product development at National Semiconductor Corp., Santa Clara, Calif., will examine these trends in a session on "Multiprocessor Architecture."

"On an aggregate-performance level, a multiprocessor architecture exceeds what the higher performance minicomputers can do," says Payne. "And what's more, the price/performance is dramatically improved compared to minis," says Payne.

According to Payne, a new industry—the multicomputer—has been created as a result of multiprocessor architectures. The panel will examine how companies can incorporate existing standards, commonly used programming languages and current operating systems. The session also will look at how standards create new markets by allowing companies to quickly develop products.

AI rates top priority

Artificial intelligence, a primary concern at last year's NCC, still remains a high-priority topic because AI applications are just starting to become available. David R. Brodwin, a senior consultant at Arthur D. Little Inc., San Francisco, will chair a panel on "Artificial Intelligence for Personal Computers."

According to Brodwin, a half-dozen AI packages are now available that introduce this advanced concept to the personal computer user. "We've reached the point where personal computers are powerful enough—and AI developers clever enough—so that the two segments of the

industry are beginning to overlap," he comments.

Products such as Timm from General Research Corp., Clout from Microrim Inc. and M.1 from Teknowledge Inc. will be discussed. "These products illustrate the range of what's going on in this market segment today," says Brodwin. "We will look at these products, their commonalities, and determine what direction this market might take in the future."

Also included within the session will be a discussion of how AI relates to expert systems and natural languages. "There's a movement afoot to develop a system on a specialized hardware system, such as a symbolics machine, and then translate it down to a run-time version for the personal computer," Brodwin explains. "That will probably happen in calendar-year '85 and will dramatically speed up the use of AI on personal computers."

SNA connects at NCC

In honor of the 10th anniversary of IBM Corp.'s Systems Network Architecture, the industry giant, in conjunction with NCC, will present a session called "IBM's SNA: Meeting the Challenge of Change."

There will also be a discussion entitled "Arrival of LAN Operating Systems," led by Noel E. Schmidt, director of major products at Architecture Technology Corp., Minneapolis.

Schmidt maintains that one of the major obstacles preventing local area network technology from taking hold is the insufficient functionality of operating systems for developing applications on top of those networks.

"Now that a few products are available that provide the necessary functionality, we can discuss a few of the issues involved in selecting one of those systems, and the things people should look for in those products," Schmidt says. The panel also will look at several products, discuss their important features and consider what makes superior products.

Despite low attendance and a lack of new product announcements at other computer shows this year, officials from the American Federation of Information Processing Societies Inc.—the sponsors of NCC—remain optimistic about the conference. Although they won't speculate on the number of attendees, spokesmen point out that more than 700 exhibitors will be present. □

Interest Quotient (Circle One)
High 480 Medium 481 Low 482

Introducing the little backup with the 20 megabyte appetite.

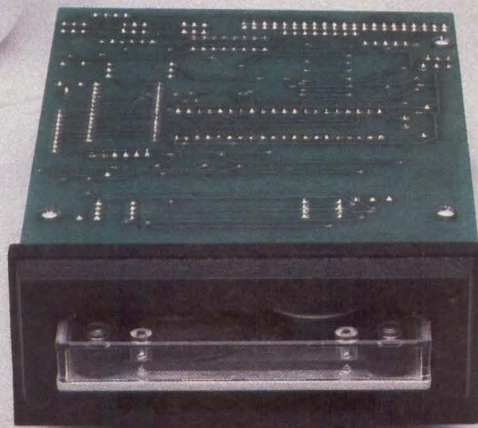

When Irwin came out with the Irwin 110 and 210 tape drives, both of which fit 10 megabytes of formatted capacity in a DC-1000™ cartridge, a lot of people said we bit off more than we could chew.

A lot of people ate their words.

Now we're backing you up with the Irwin 125 tape drive—20 megabytes of formatted data on a DC-1000 cartridge.

The Irwin Recipe: Simplicity, Reliability, and Ease of Use.

Because the Irwin 125 has a standard minifloppy interface, it daisy chains right onto your existing controller — without any additional cables, controllers or hardware. Add a simple software driver and an applications program for file transfer or streaming, and the Irwin 125 is ready to go.

And if you are PC DOS compatible we'll provide you with all the software required—without charge!

Irwin's closed-loop servo technology guarantees simpler operation, media interchangeability and greater reliability. With an error rate of 1 in 10^{11} and MTBF greater than

12,000 hours, the Irwin 125 is one of the most reliable, trouble-free back-up drives available anywhere today.

The Biggest Surprise is the Little Price.

Best of all, the cost of the Irwin 125 tape drive is about the same as a floppy disk drive. And it provides from 20 to 40 times the storage capacity on a single cartridge.

For those who don't need 20 megabytes of storage capacity, there's the Irwin 110, a 5 ¼ -inch half-high and the Irwin 210, a 3 ½ -inch form factor. We put a big byte in every backup we build.

If we've whetted your appetite, perhaps it's time you ordered a 125 tape drive for evaluation.

Irwin Magnetics. We back you up with integrity.

The DC-1000, 185 feet of .150" width tape, is a trademark of the 3M Company.

Irwin Magnetics
2311 Green Road
Ann Arbor, Michigan 48105
313/996-3300
TWX 810-223-6050

IRWIN™
IRWIN
MAGNETICS

CIRCLE NO. 78 ON INQUIRY CARD

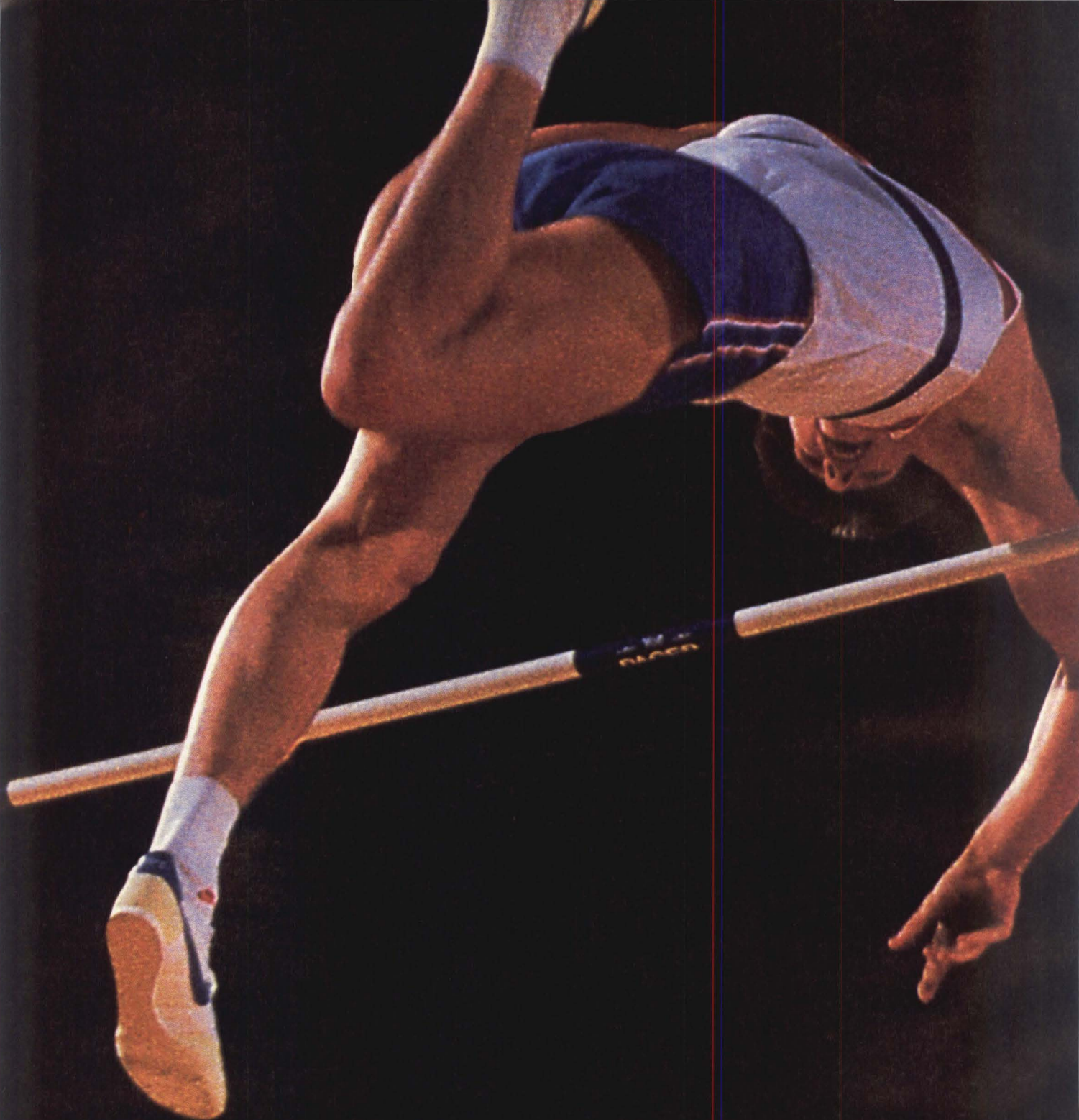

© 1985 Qume Corporation. VT 100 is a registered trademark of Digital Equipment Corporation, DEC, and VT 220 are trademarks of Digital Equipment Corporation. ANSI is designed to American National Standards Institute, Inc., ANSI X3.64-1979 guidelines.

Qume raises terminal standards. Again.

Qume's four new QVT™ alphanumeric terminals just passed the most gruelling test in terminal history — 25,000 hours without a single repair. That's more than double the 10,000-hour industry average. But that's not the first time Qume has raised standards. Nor the last.

Qume was first with affordable ergonomic design. First with a one-year end-user warranty. First in support. First in value. And now, first with unparalleled reliability in a full line of affordable terminals.

Our QVT 101™ is the first full-featured ASCII editing terminal under \$400. Our QVT 119™ is the most powerful ASCII terminal on the market. Together, they offer total ASCII flexibility.

In the DEC environment, Qume's new QVT 202™ ANSI terminal is a 100% VT 220 emulation with better ergonomics than the VT 220 itself. Our new QVT 201™ ANSI terminal provides 100% VT 100 emulation with VT 220 software compatibility. Both offer lower costs *plus* Qume's pace-setting quality.

Every QVT alphanumeric terminal is backed by Qume's resources and experience as an ITT company. You know we'll be there to support you from start to finish. For more information on Qume's full line of alphanumeric and graphics terminals, daisywheel printers, printer supplies, or disk drives, call (800) 223-2479. Or write Qume Corporation, 2350 Qume Drive, San Jose, CA 95131.



We'll be there.

Qume®
A Subsidiary of ITT

CIRCLE NO. 79 ON INQUIRY CARD

NEW PRODUCTS

SYSTEMS

Eileen Milauskas, Assistant Editor

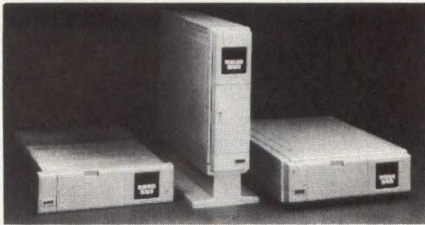

Micro works with Multibus

- Foundation Module
- 512K-byte memory
- 12M-byte Winchester

Multibus compatible, the SMS 8000 model 40 microcomputer system runs CP/M-86 operating system and application software developed for Intel's RMX 86 or XENIX operating systems. Employing either the 8086 or the 80286 processor, the system comes with 512K bytes of main memory, expandable to 6M bytes. Storage capacities include a 12M- to 128M-byte Winchester disk drive, a 1.2M-byte, 8-inch or 1.6M-byte, 5¼-inch floppy-disk drive and a 60M-byte streaming tape drive. An integrated, single-board Foundation Module, requiring no backplane slot, includes peripheral controller, backplane interface, parallel priority resolution circuitry and the Support Monitor Subsystem, which contains software used for system analysis, system utilities and diagnostics. \$5,900. **Scientific Micro Systems Inc.**, 339 N. Bernardo Ave., Mountain View, Calif. 94043, (415) 964-5700.

Circle 300

Display system meets IGES standard

- 512-color display
- 13-inch monitor
- Digitizer tablet

Accepting CAD/CAM drawings produced by IBM mainframe software such as CADAM and converted to the Initial Graphics Exchange Standard (IGES) data format, the Vectrix display system displays the drawings with variable view-

ing transformations, annotates and highlights the drawings and generates hard copy output without mainframe support. The base of the system includes a personal computer storing 256K bytes of main memory, one 360K-byte floppy disk and one 10M-byte hard disk, with two RS232C interfaces and one parallel printer interface. The proprietary VX/PC graphics processor supports 80 internal graphics primitives, 672-by-480-pixel resolution and 9-bit planes for 512-color display from a palette of 4,096 colors. The 13-inch, RGB monitor achieves a 42-Hz video-scan rate. Other system components include an 11-by-11-inch digitizer tablet with 200-point-per-inch resolution and an inkjet printer and plotter accommodating 8½-inch-wide rolled paper and four ink colors. Software executes personal-computing, communications, terminal-emulation, file-transfer, IGES-plotting and IGES data-conversion functions. \$17,000. **Vectrix Corp.**, 2606 Branchwood Drive, Greensboro, N.C. 27408, (919) 288-0520.

Circle 301

Workstations suit multiple protocols

- 650K-byte drive
- SNA, BSC compatible
- Dual processors

Compatible with 3270 SNA, 3270 BSC, 3780 and TTY-ASCII protocols, the Concept 1200 and 1400 workstations provide DEC VT100 terminal emulation. Accessing on-line information suppliers, public information utilities and mainframe environments, they support DISOSS and PROFS sessions. Equipped with 256K bytes of memory, the model 1200's dual-processor architecture facilitates compatibility; the 8088 microprocessor handles 16-bit MS-DOS software, while the Z80B delivers CP/M packages. Using the proprietary PC-Touch add-on board, it also runs PC-DOS programs. Both the 1200 and the 1400 run the H-DOS operating system and Lanier office-automation software. Employing the 8086 and Z80B microprocessors, the Concept 1400 operates as a dedicated word processor and as

a network workstation. Storing 512K bytes of memory, the system runs the CP/M operating system. A 650K-byte disk drive and a 10M-byte Winchester disk drive are supported by both models. \$3,200, Concept 1200; \$4,500, Concept 1400. **Lanier Business Products Inc.**, 1700 Chantilly Drive N.E., Atlanta, Ga. 30324, (404) 329-8000.

Circle 302



Graphics system emulates IBM 5080

- 256-color display
- VMEbus-based
- Antialiasing capability

Emulating the IBM 5080 Graphics System, the model 6080 workstation employs the VMEbus. Based on the proprietary OCEAN graphics engine, the system comes with 256K bytes of memory, expandable to 1.25M bytes. Its 19-inch, 60-Hz, non-interlaced display produces 256 colors from a palette of 4,096. Pixel resolution is 1,024 by 1,024; drawing speed, at 50 nsec. Compatible software includes CADAM Inc.'s CADAM and IPC packages, SDRC's CAEDS, McDonnell Douglas's Unigraphics and Precision Visual's DI-3000. Features include an antialiasing capability for vectors, multiple highlighting techniques, high-speed circle generation, hardware cursor, alphanumeric keyboard with 32 programmable function keys, 11-by-11-inch data tablet, eight continuous-turn control dials and optional local pan/zoom/scroll capability. \$18,000, monochrome system; \$22,000, 16-color system. **Adage Inc.**, 1 Fortune Drive, Billerica, Mass. 01821, (617) 667-7070.

Circle 303

Where does the Personal Terminal fit in?

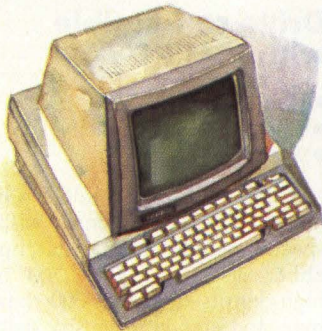

It fits everywhere big terminals won't. And everywhere a portable, low cost terminal will. Want proof? Call or send us a fitting application idea of your own, and we'll give you a free hands-on demonstration of the Personal Terminal. But be forewarned: where this terminal fits in, it invariably stays in.

For further information call TeleVideo® Terminals at (800) 538-8725. In California call (800) 345-8008.

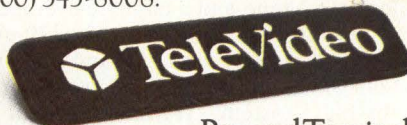
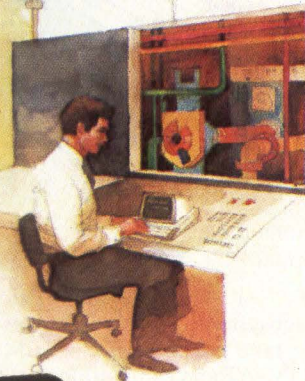

Personal Terminal
TeleVideo Systems, Inc.

The size of things to come.

Regional Sales Office: California/Santa Ana (714) 476-0244, California/Sunnyvale (408) 745-7760, Georgia/Atlanta (404) 447-1231, Illinois/Chicago (312) 397-5400, Massachusetts/Boston (617) 890-3282, New York/New York (516) 496-4777, Texas/Dallas (214) 258-6776.

CIRCLE NO. 80 ON INQUIRY CARD

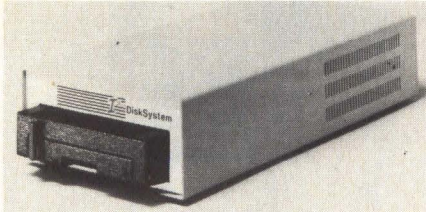

Subsystem provides removable storage

- Cartridge
- 10.5M bytes
- PC-AT-compatible

A removable cartridge disk system, the Winchester DiskSystem stores 10.5M bytes per cartridge and provides multi-user capability to the IBM PC-AT. Fitting into the B drive of PC-AT, the drive achieves a track-to-track access time of 22.5 msec and an average access time of 90 msec, including head-settling time. Data transfer rate is 5M bps. External version of the unit is available for the IBM PC in primary or slave-drive configuration. \$1,695. **Interface Inc.**, 21101 Osborne St., Canoga Park, Calif. 91304, (818) 341-7914. **Circle 304**

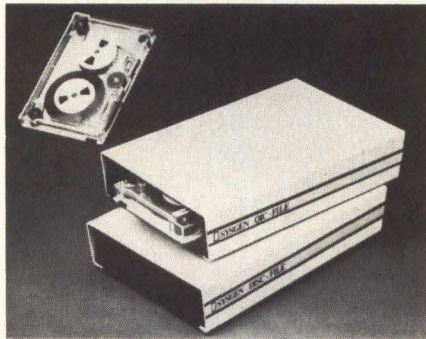

Subsystem executes tape backup

- 45M bytes
- IBM PC-compatible
- QIC-24 format

QIC-FILE, a half-height, cartridge-tape subsystem, offers 45M bytes of streaming tape backup for the IBM PC, PC/XT, PC-AT and compatible computers. Restoring and backing up data at 4M bytes per minute via 1/4-inch streaming tape, the system offers mirror-image and file-by-file backup. In file-by-file backup mode, files are archived by file, groups of files, date or time. Comment lines for each file can be created. Supporting the QIC-24 format, the unit records in a nine-track serpentine mode. A

“verification-on-the-fly,” error-correction feature checks and, if necessary, rewrites transferred data. \$1,395. **Sysgen Inc.**, 47853 Warm Springs Blvd., Fremont, Calif. 94539, (415) 490-6770.

Circle 305

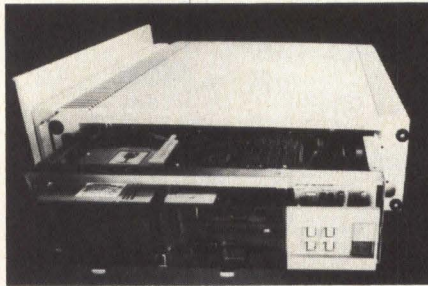

Upgrade kit suits DEC systems

- Streaming tape
- Floppy disk drive
- 22-bit addressing

Offering backup capabilities for DEC's Micro PDP-11 and MicroVAX, the Microsafe upgrade kit consists of a half-height, streaming-tape cartridge drive coupled with a half-height, floppy disk drive. Emulating DEC's TS11 controller command set, the unit executes RT11, 10M-byte file backup in 7 minutes and 10M-byte device backup in 3 minutes. RSX backup of 31M bytes is performed in 8 minutes. The system supports 22-bit addressing. \$3,500. **Micro Technology Inc.**, 1620 Miraloma Ave., Placentia, Calif. 92670, (714) 632-7580. **Circle 306**

Drives employ ST506 interface

- 10M, 12M bytes
- 11,000-hour MTBF
- Half-height

Incorporating the ST506 interface, the models 512 and 525, 5 1/4-inch, half-height Winchester disk drives store 10M and 12M bytes, respectively. Model 512, using a linear positioning system, achieves a 23-msec track-to-track access time and a 65-msec average access time. Model 525, offering a 20-msec track-to-track access time and an 85-msec average access time, employs a rotary positioning system. Transferring data at 5M bps, both models reach an 11,000-hour MTBF and are based on a direct-drive, brushless DC spindle motor, a dynamically balanced motor/spindle assembly and shock-mounted baseplate to reduce vi-

bration. The stepper and spindle motors are thermally isolated. \$375, model 512, Q1000; \$595, model 525, Q1000. **Disc Tech One Inc.**, 849 Ward Drive, Santa Barbara, Calif. 93111, (805) 964-3535.

Circle 307

File system adds streaming tape

- 30M-byte disk drive
- 45M-byte tape drive
- 64K-byte controller

Combining a 30M-byte hard disk drive with a 45M-byte streaming tape drive, the model 6097 disk/tape file system offers a 30M-byte image backup and restore in 7 minutes. Employing SCSI, the system includes a 64K-byte buffered controller and menu-driven tape utility, file-level restore capability to any device, media and data protection via a dedicated landing zone and 56-bit error detection and correction. \$5,700. **NCR Corp.**, Product Marketing, P.O. Box 20077, Wichita, Kan. 67208, (316) 688-8510. **Circle 308**

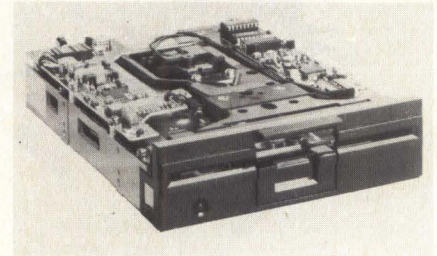

Drive compatible with IBM PC-AT

- Half-height
- 1M, 1.6M-byte capacity
- 96 tpi

The model M4854-1/3S 5 1/4-inch, half-height disk drive comes with a dual-speed, spindle motor that operates at either 360 rpm with 1.6M bytes and high-density media or 300 rpm with 1M byte and standard-density media. Plug-compatible with the IBM PC-AT, the unit has two magnetic heads and offers 10,416 bytes per track (high density) and 6,250 bytes per track (standard density). Track density is 96 tpi. A stepping motor and steel band facilitate a 3-msec track-to-track access time. \$160. **Mitsubishi Electronics America**, 991 Knox St., Torrance, Calif. 90502, (213) 515-3993.

Circle 309



**October 15, 1985 ...
thousands of
European computer
equipment resellers
will converge on
Amsterdam.**



They're coming to COMDEX/Europe to see, test and make agreements to sell the products you supply: computers, software accessories, peripherals, computer furniture, supplies, media and anything else that is used with, by or for computers.

COMDEX/Europe is the only computer event that

attracts all categories of computer related Independent Sales Organizations (ISOs) in all the countries of Europe.

If you do business in Europe, or if you would like to establish a presence in this booming, high-potential market, COMDEX/Europe '85 is the best opportunity to expand your distribution network and meet YOUR profit objectives.



For latest exhibit space availability information, call (617) 449-6600.

COMDEX/Europe '85
15-17 October 1985
RAI EXHIBITION CENTRE
Amsterdam, The Netherlands



World's leading producer of computer conferences and expositions including: COMDEX/Winter, COMDEX/Spring, COMDEX/Fall, COMDEX/Europe, COMDEX in JAPAN, INTERFACE, FEDERAL DP and COMMUNICATIONS Conference & Expo, The Nationwide COMPUTER SHOWCASE EXPOs and THE BYTE COMPUTER SHOWS.
©Copyright 1985 • 300 First Avenue, Needham, Massachusetts, USA 02194 • (617) 449-6600 • TELEX - 951176 • FAX (617) 449-6953
In Europe: World Trade Center, Tower C, 12th Floor, Strawinskylaan 1245, 1077 XX Amsterdam, The Netherlands • Telephone (31) 20-621941 • TELEX - 12358 • FAX (31) 20-621322

Offices in: Los Angeles San Francisco Washington, DC Amsterdam Tokyo

NEW PRODUCTS

PRINTERS

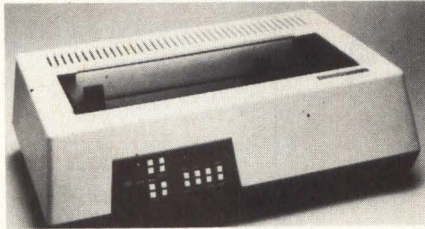

Printer emulates IBM 3287

- 180 cps
- SNA support
- Nine-wire printhead

The model CX3180 dot-matrix printer, which emulates the IBM 3287 printer, does not require an outboard protocol converter. It attaches directly to the IBM 3274 or 3276 cluster controller or 4331 display printer adapter via an IBM type A coaxial connector. It supports IBM BSC, SNA or SDLC environments as well as a transparent mode. Printing a 9-by-7-dot matrix at 180 cps, the bidirectional, logic-seeking unit generates 132 characters at 10 cpi, 158 characters at 12 cpi or 217 characters at 16.5 cpi. Its nine-wire printhead handles six-part forms and generates 500 million characters. Features include a Centronics-compatible parallel interface, LED indicators and a four-digit display prompt. Settings are stored in non-volatile memory. \$3,195. **Datasouth Computer Corp.**, 4216 Stuart Andrew Blvd., Charlotte, N.C. 28210, (704) 523-8500. **Circle 310**

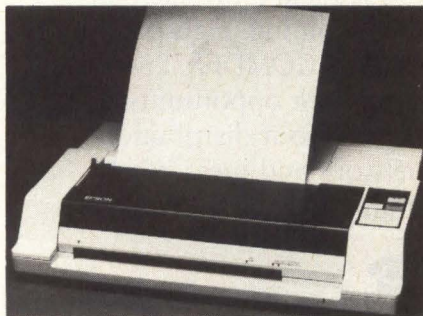

Plotter offers 42 commands

- 9 ips
- 10 colors
- Four pens

Compatible with Epson, IBM and Apple computer systems, this four-pen plotter provides 42 intelligent commands that reduce programming time required to produce pie charts, bar and line

graphs, circles, arrows and arcs. Operating at 9 ips, the unit plots four of 10 available colors on U.S. and international-size papers and on acetate for overhead projection displays. It comes with a parallel interface. \$599. **Epson America Inc.**, 3415 Kashiwa St., Torrance, Calif. 90505, (213) 539-9140. **Circle 311**

Matrix printer is Epson-compatible

- 130 cps
- 6-by-9-dot matrix
- 2K-byte buffer

Printing 130 cps, the Alphacom Aero impact dot-matrix printer is compatible with graphics and business software that uses Epson RX80 printing protocols. Employing a nine-wire printhead, the unit prints either 480 or 960 dots per line in an alphanumeric mode allowing 96 ASCII characters or bit-image mode in a 6-by-9-dot matrix. Superscripts, subscripts, double strike, enlarged and emphasized type, underlines and print modes may be mixed on the same line. Pin-on-platen and friction feeds accommodate perforated computer and regular bond paper. The unit can print an original and up to three copies. Operator controls include power, on-line, form-feed and line-feed. Features include self-test, 2K-byte data buffer and path-seeking logic. \$399.95. **Alphacom Inc.**, 2323 S. Bascom Ave., Campbell, Calif. 95008, (408) 559-8000. **Circle 312**

Printer creates presentation graphics

- Ink-jet printing
- 154 dpi
- Eight colors

Combining color printing and graphics processing, the LCP01 ink-jet printer forms business-presentation graphics on paper and transparencies. Employing the proprietary J-11 microprocessor and page-buffer memory, the printer requires 2 minutes to provide a hard-copy image on 8½-by-11-inch or European A4-size paper. The unit uses eight colors in up to 216 shades to produce 154-dpi resolution. Connecting to the host CPU via a standard RS232C interface, the printer feeds, processes and stacks 100 sheets of paper or 50 transparencies automatically. Noise level is 58 dB(a). The



proprietary DECslide, DECgraph, Data-trieve and PRO/Graphics Interface Descriptor Instruction Set (PRO/Gidis) software is supported as well as packages based on Remote Graphics Instruction Set, Gidis, North American Presentation Level Protocol and Bit-Map Image protocols. \$14,595. **Digital Equipment Corp.**, 146 Main St., Maynard, Mass. 01754, (617) 897-5111. **Circle 313**

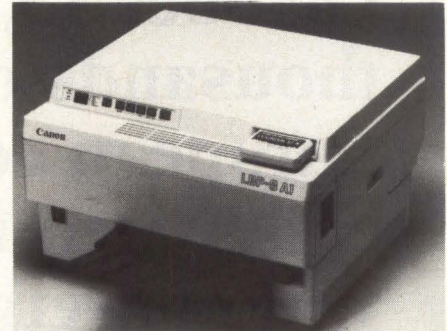

Laser printer generates 850 cps

- 300 dpi
- 55 dB(a)
- Electrophotography

The LBP-8 A1, a compact personal laser-beam printer, interfaces with IBM PC-compatible personal computers. Based on a laser-print engine and an electrophotography printing method, the unit uses a semiconductor laser, a rotating multifaceted mirror, focusing optics and replaceable proprietary EP cartridges. Printing over 850 cps or 8 ppm, the printer achieves 300-dpi resolution and operates at 55 dB(a). \$3,500. **Canon U.S.A. Inc. Copier Products Division**, 1 Canon Plaza, Lake Success, N.Y. 11042, (516) 488-6700. **Circle 314**

Get results with

Mini-Micro Systems

CAREER OPPORTUNITY SECTION...

When you advertise in **Mini-Micro Systems**, you can be sure of reaching only the people you are trying to recruit. Every reader is a potential employee. We reach the highest percentage of all significant personnel in our industry. You'll find us not only effective, but a more economical magazine.

for space reservation
contact:

Norma Lindahl
617-964-3030

TERMINALS

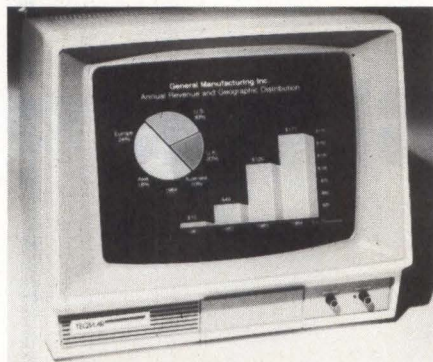

Monitor produces 640 by 480 pixels

- IBM PC-compatible
- High bandwidth
- 16 colors

Suited for engineering, software-development or CAD applications, the Tecmar color monitor's higher bandwidth and long-persistence phosphor reduces flicker and results in a more stable image. Working with the IBM PC and compatible systems, the monitor gene-

rates 16 colors and achieves 640-by-480-pixel resolution. The screen is switch-selectable from color to green for text material. The monitor complements the proprietary Graphics Master enhancement board, which is bundled with the PC Paintbrush software program. \$795. **Tecmar Inc.**, 6225 Cochran Road, Cleveland, Ohio 44139-3377, (216) 349-0600. **Circle 315**

Display station emulates IBM 5291

- Multifunction mouse
- Zoom control
- Light-pen function

The GBT 7700, an IBM System/34-, /36- and /38-compatible display station, offers an optional, 3-button mouse which features zoom control, vertical and horizontal scrolling, multidirectional cursor control and a light-pen function. Emulating the IBM 5291 terminal, the unit's 14-inch, green or amber screen displays 24 lines by 80 characters with a 25th



status line in a 7-by-9-dot matrix. Display features include automatic dimming with on/off and individual brightness and contrast control. Operator features include audible alarm volume on/off, keyboard clicker volume and on/off and operator-selectable, IBM 5291 and 5251 keyboard alarm/clicker emulation. A record/play mode consists of a 96-character memory. The terminal provides user-generated characters for custom design of the cursor symbol, alternate, displayed character sets and forms generation. \$1,650; \$150 for mouse. **General Business Technology Inc.**, 1891 McGaw Ave., Irvine, Calif. 92714, (714) 261-1891. **Circle 316**

C68 C COMPILER FOR MC680X0

- ▶ Hosted on Motorola, DEC, HP, Tektronix, and Alcyon Computers
- ▶ Generates highly optimized code
- ▶ Produces ROM-able tasks that execute stand alone or under OS
- ▶ Includes Assembler, Linking and Downline Loaders, and Runtime Libraries
- ▶ \$1495.00

Alcyon
CORPORATION

8716 Production Avenue • San Diego, CA 92121 • (619) 578-0860 TELEX 18-1776



Terminal handles spreadsheets

- Block mode
- 16 function keys
- 80, 132 columns

Accommodating word-processing, financial spreadsheets and editing functions, the ADM 12plus block-mode terminal is compatible with the TeleVideo 925, 950, 912 and 920 terminals and with the proprietary ADM 2, ADM 12 and ADM 13. The unit provides two pages of 80- or 132-column-by-24-line display memory, plus a 25th status line, or a choice of wide- and long-page memory

CIRCLE NO. 83 ON INQUIRY CARD

configurations. A four-page memory option adds a 158-column-by-48-line display memory format. Offering a 12-inch, green or amber screen, the terminal includes variable-speed, vertical and horizontal scrolling, 400 bytes of dynamically-allocated, function-key memory and 16 programmable function keys, shiftable to 32. \$745. **Lear Siegler Inc., Data Products Division**, 901 E. Ball Road, Anaheim, Calif. 92805, (714) 778-3500.

Circle 317

Terminal offers 64 function keys

- 80 or 132 columns
- Block graphics
- 14-inch screen

Accommodating office-automation applications such as word processing, data entry and information retrieval, model 955 displays 24 lines by 80 or 132 columns in a 7-by-9-dot matrix on a 14-inch, amber screen. Two sets of 32 programmable function keys permit switching between applications without reprogramming. Storing up to four pages of memory, the unit generates 128 ASCII and 128 graphics characters. Features include block graphics, vertical scrolling, silent convection cooling, software-selectable baud rates up to 38.4K bps, cursor control, embedded and non-embedded visual attributes, screen timeout and two RS232C serial interfaces. \$699. **Tele-Video Systems Inc.**, 550 E. Brokaw Road, San Jose, Calif. 95112, (408) 971-0255.

Circle 318

Editing terminal has multiple emulations

- 16 functions
- 14-inch screen
- Block mode

Emulating the Hazeltine 1500, the Lear Siegler ADM 3A/5 and the Tele-Video 910, the QVT-101 terminal provides 16 host or user-programmable functions and a 14-inch green screen. Features include block-mode data transmission, bidirectional printer port, RS232 interface, foreign character sets and a detached, low-profile, DIN-standard keyboard with adjustable height. Amber screen and current loop or RS422 interfaces are optional. \$400. **Qume Corp.**, 2350 Qume Drive, San Jose, Calif. 95131, (408) 942-4000.

Circle 319

SWITCHING TERMINALS A PROBLEM?



has a lineup of low cost, reliable RS232 interface problem solvers.



THE ANY-PORT-TO-ANY-PORT SMART SWITCH

- Allow more users to share the computer.
- Connect to multiple computer systems and equipment.

Here's an affordable way to switch up to eight RS232 ports in any interconnection. Any port can select any other port, with up to four pairs communicating at the same time. "User friendly" commands aid in port selection, port status and sign-off. The unit even signals you when the port you wanted is no longer busy. Push buttons define each port as either DTE or DCE, for quick and easy installation.

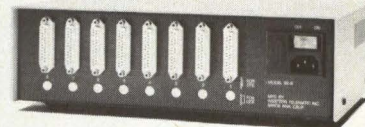

Model SS-8 = \$895.

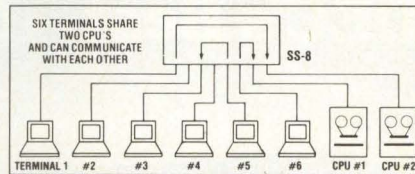
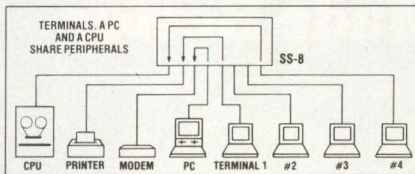

4 PORT PUSH BUTTON SWITCHING



Fed up with the hassle of plugging and unplugging data cables or running around flipping switches on a mechanical box? The TM-41 electronic switch is capable of switching common RS232 signals between 4 input ports and 1 output port to select a printer, modem or computer. **Model TM-41 = \$295.**

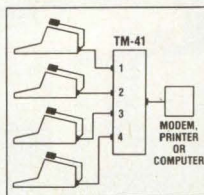

PRINTER SHARING UNIT



The PSU-41 allows up to 4 computers or CRTs to share one printer. It scans each port until the data has been sent to the printer, then resumes scanning. **Model PSU-41 = \$395.**

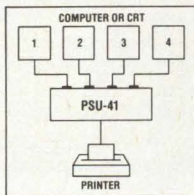

AB MINI SWITCH...\$89.00



The ABS provides economical push button switching between two ports A & B, and a common port.

4 TO 64 PORT CODE ACTIVATED SWITCHING



Let your computer do the switching... automatically!

The CAS-41 lets your computer select one or any combination of up to 4 RS232 ports by a user selectable code sequence. The CAS-161 offers the same capabilities with 16 ports which can expand to 32, 48 or 64 ports.

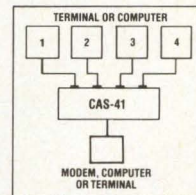

Model CAS-41 = \$395.
Model CAS-161 = \$795.

2 TERMINALS SIMULTANEOUSLY SHARE ONE MODEM!

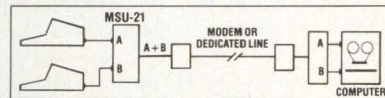

The MSU-21 allows 2 ASCII terminals to simultaneously share one modem or data line. **MSU-21 = \$295.**

AND MUCH MORE!

- Printer Buffers
- Data Cables
- Multiplexers
- Line Boosters

Send for your complete catalog. We are continuously adding new products, so if you don't see what you want, give us a call. We help hundreds of people solve their RS232 switching problems.

Call toll free for immediate information...

1-800-854-7226



western telematic inc.

2435 S. Anne St., Santa Ana, CA 92704 • (714) 979-0363 • Telex 467741

CIRCLE NO. 84 ON INQUIRY CARD

Network connects LANs, WANs

- Password protection
- 19.2K-bps support
- RS232 links

Based on the proprietary Compatible Communications Architecture protocol,

the FutureCom 2000 integrated area network connects multiple LANs and WANs into a single network. The network consists of the LS-2000 local server, the RS-2000 remote server and the NS-2000 network server. The local server concentrates data traffic from up to 32 devices on a LAN. The remote server establishes



virtual-circuit connections between user resources in WANs. Working with the network server, the remote server allows access to resources attached to LAN nodes. Dynamic resource access permits request to access to another resource on the same or different on-line nodes. The remote server uses logical names without needing to know where the resource resides. The remote server connects up to 32 channels, with four RS232 concentrated links. As a gateway node bridging different, and normally incompatible, transmission media, the network server functions as an Ethernet controller with one Ethernet link and up to four RS232 wide-area links. Providing password-protection security, the network supports 19.2K-bps data transfer speeds and asynchronous speeds from 300 to 9,600 bps per channel. \$5,800, NS-2000; \$4,300, LS-2000; \$3,800, RS-2000. **ComDesign Inc.**, 751 S. Kellogg Ave., Goleta, Calif. 93117-3880, (805) 964-9852. **Circle 320**



Concentrators handle 16 terminals

- X-on/X-off support
- CTS/DTR control
- 9,600-bps lines

Enabling from two to 16 asynchronous terminals to share a single transmission line, the Series B line of data concentra-

FREE SYSTEMS CATALOG
**Out of the Darkness...
 DEC's Best – Made Better**

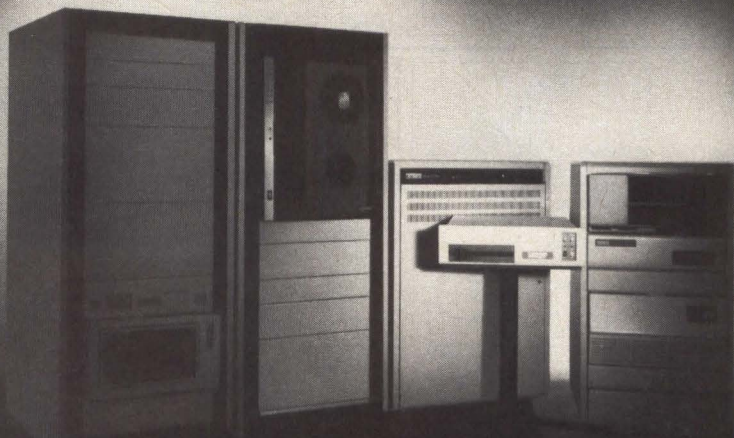

In the dark about detailed system configuration? At CDS we customize DEC-based systems to YOUR specifications, not vice-versa. And we use only the finest high performance equipment and high level applications. That's how we make the best systems even better!

Systems and software for Data

Acquisition, Process Control, Software Development and Office Automation based on equipment from DEC, Fujitsu, CDC, Cipher, Emulex, Sigma, Interlan, Data Translation and others.

So, call for a **FREE** catalog, or better yet, talk to a salesman. There's no need to feel like you are still in the dark.

**Cambridge
 Digital**

The Edge in Value-Added DEC Systems

800-343-5504

In MA call 617-491-2700 • In NY call 516-935-3111
 P.O. Box 568 • 65 Bent Street • Cambridge, MA 02139

tors buffers data prior to transmission, transmits variable-length blocks, checks data received on 9,600-bps lines and requests retransmission in the event of error. Features include command port, autobaud and speed conversion, satellite transmission optimization, data compression and diagnostics. The command port performs monitoring, test and control functions while the terminal-activated channel test allows any terminal attached to the concentrator to check the system. The concentrators support X-on/X-off or CTS/DTR flow control. \$1,450 to \$7,050, two-to-eight-channel versions. **Black Box Corp.**, P.O. Box 12800, Pittsburgh, Pa. 15241, (412) 746-5500. **Circle 321**

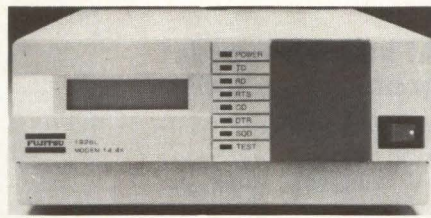

continual basis. It can bridge dropouts of up to 2 seconds. Features include LED indicators, an LCD, an eye-pattern generator and diagnostics that test six different loops and complete network bit-error rate. \$6,875. **Fujitsu America Inc.**, 3055 Orchard Drive, San Jose, Calif. 95134-2017, (408) 946-8777. **Circle 323**

Modem runs at 19.2K bps

- Multiplexer
- Addressable analogs
- Digital loopbacks

Operating synchronously at 9,600, 12K, 14.4K, 16.8K and 19.2K bps or asynchronously using an async-to-sync converter, the DSP 19200M data modem accommodates four-wire, type 3002 leased telephone lines with D1 conditioning. Offering an eight-port data multiplexer, the modem employs error correction based on trellis coding. Diagnostic tests include addressable analog and digital loopbacks, bit-error rate and polling tests with error-count display on the front panel. \$12,000. **NEC America Inc.**, 8 Old Sod Farm Road, Melville, N.Y. 11747, (516) 753-7000. **Circle 322**

Modem operates at 14.4K bps

- Full-duplex
- CCITT V.29 standard
- Six-channel multiplexer

Accommodating four-wire, leased lines, the model M1926L 14.4K-bps, full-duplex, Trellis-coded modem runs at fallback speeds of 9,600, 7,200 or 4,800 bps. Conforming to the CCITT V.29 standard, the modem includes a six-channel multiplexer that allows up to six 2,400-bps channels to be transmitted simultaneously over a single leased telephone line. The unit serves point-to-point, multipoint or multipoint polling system configurations and provides an automatic adaptive equalizer that adapts to transmission line characteristics on a

GIGADISC
DIRECT ACCESS TO MEMORY POWER



The GIGADISC laser optical disk system is built rugged enough for many industrial applications . . . smart enough for the sophisticated office automation and EDP environments.

GIGADISC's high-capacity storage capability will allow you to utilize laser optical disk technology in any application specifying low-cost mass storage. Today's requirements in the medical, military, office automation and EDP environments demand efficient, easy-to-access data storage with reliability only GIGADISC Memory Power can provide.

Call us before you design your next system.



GIGADISC

US Headquarters:
 210 Avenue I, Suite D
 Redondo Beach, CA 90277
 (213) 543-5537

European Headquarters:
 In France Call: (1) 630-24-72

A PC is a terrible thing to waste!



Is your PC being used productively? Or are you using it for non-processing tasks? Techtran's new 990 Disk Recorder, featuring IBM PC* compatibility, is a stand alone data recorder/terminal which allows your PC to do what it does best... **COMPUTING!**

Offering MS-DOS*, Z-DOS*, PC-DOS* media, directory, and file structure compatibility—your PC will be free for more productive tasks. Data recorded on the 990's disk can be processed on your PC...and it works the other way around too! Remote polling, unattended operation, two RS-232C ports, and data transfer speeds from 110-19,200 bps will give your PC the **PRODUCTIVE EDGE!**

CALL OR WRITE FOR MORE INFORMATION TODAY.



200 COMMERCE DRIVE ROCHESTER, NEW YORK 14623
PHONE (716) 334-9640/TWX 510-253-3246

*IBM PC and PC-DOS are registered trademarks of IBM Corporation.
Z-DOS is a registered trademark of Zenith Data Systems.
MS-DOS is a registered trademark of Microsoft Corporation.

CIRCLE NO. 87 ON INQUIRY CARD

NEW PRODUCTS SOFTWARE

AI software aids problem-solving

- 16,000 rules
- 256,000 facts
- IBM PC-compatible

Requiring no programming ability, Autologic software helps to solve diagnostic, policy-interpretation and decision-making problems by analyzing cases and producing logical, English-language rules for the expert. The software provides a means for an expert to incorporate knowledge in an "expert system" for subsequent use by a non-expert. Written in assembly language, the package consists of three parts: the development system, the knowledge modules and the playback module. It requires an IBM PC or PC-compatible for development or playback. Producing up to 16,000 production rules, the system stores 256,000 facts, 4,096 cases and conclusions and 512 conditions per case. A full expert system can be stored on a 5¼-inch floppy disk. Each question and answer is explained with a 736-character help screen. \$795, development system; \$150, playback utility. **KDS Corp.**, 934 Hunter Road, Wilmette, Ill. 60091, (312) 251-2621. **Circle 324**

Windowing software suits XENIX OS

- 10 windows
- Pan function
- Data-transfer facility

Operating on the IBM PC-AT and the

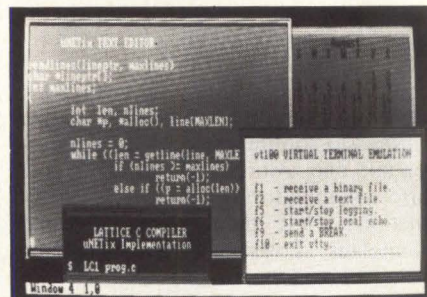

IBM PC/XT running the XENIX operating system, Viewnix software configures up to 10 windows that can be expanded, contracted or overlapped. A pan function scans over a larger, underlying window buffer should too much displayable data appear on the screen. A cut-and-paste capability facilitates integration of data between different applications while a data-transfer facility copies a block of data from one window and types it into a process running in another window. When in window-management mode, a status line displays the currently selected window-management function. Additional features include a border toggle, color monitor support and caps lock and numeric lock settings. \$249. **Five Paces Software Inc.**, 9635 Wendell Road, Dallas, Texas 75243, (214) 340-4933. **Circle 325**

Software executes problem-solving

- Report generator
- Linear analysis
- Calculus functions

ANSWERS TO MAY'S PUZZLE

	M	A	S	T	E	R	S	K	I	M	
H	A	C	K	E	R	B	E	E	E	L	
U	N	I	A	F	O	X	Y	M	E		
B	U	S	K	I	L	O	B	D	O	S	
A	R	M	D	O	T	O	U	R	S		
O	L	A	F	E	W	K	A	T	Y		
R	D	I	R	E	C	T	O	R	Y	D	
G	O	N	E	H	E	A	D	S	O		
H	A	L	F	E	A	R	S	E	T		
U	S	E	R	D	R	A	W	G	Y	M	
E	N	A	L	I	T	H	I	L	A		
S	E	M	E	T	B	A	C	K	U	P	
T	E	E	N	C	A	M	E	O	S		

H	A	L	O	N	A	A	I	S	S	S	C	A	N
L	M	T	H	G	I	L	H	G	I	H	O	A	
E	A	S	C	E	O	I	T	E	P	I	K	V	
V	R	W	S	N	N	L	C	T	T	P	S	I	
I	D	E	C	E	L	E	R	A	T	E	I	D	
T	I	O	T	R	N	E	Z	L	B	M	D	E	
C	D	N	M	A	G	I	S	U	E	L	X	O	
E	R	R	V	T	R	R	N	M	M	P	E	T	
P	L	A	N	E	O	B	O	I	O	E	M	A	
S	E	T	T	H	R	I	S	A	A	M	P		
R	M	S	E	S	S	Y	S	E	L	T	R	E	E
F	O	E	R	I	F	R	E	T	A	W	G	H	
P	E	T	Z	F	P	T	E	S	D	C	A	T	

NEW PRODUCTS
SOFTWARE

Running on the IBM PC, PC/XT and compatibles with 256K bytes of RAM, the Formula/one problem-solving package calculates complex mathematical equations. DOS-like commands permit on-screen editing of text and data while a "context-sensitive" HELP function provides on-line information clarifying the specific feature that the user is operating on the program. These two features enable setting up problems, varying assumptions, solving equations, plotting graphs and computing unknown variables in formulas and models. The package provides a full set of system-defined statistics, calculus functions and capabilities for performing multiple, linear-regressions analyses. A report generator creates customized displays, reports and graphs without intermediate word processing. Based on a Binary Code Decimal Arithmetic which ensures 14-digit accuracy, the program offers an error-locating feature. \$395. Alloy Computer Products Inc., 100 Pennsylvania Ave., Framingham, Mass. 01701, (617) 875-6100. **Circle 326**

Drafting system runs on VAXstation I

- Display control
- Geometric manipulation
- Database management

A 2-D drafting software system for use with DEC's VAXstation I workstation, ANVIL-3000D's geometric-construction capability creates points, lines, circles, conics, splines and polygons. It allows combinations of translations, rotations, duplications, mirroring, scaling and stretching for placement of entities created by construction. A display-control feature generates 3-D drawings, enhanced by isometric projection, automatic shaft end-view generation and sectioning with zoom capability. The package's Interactive Configurator defines the environment to only those portions of the software that relate to a particular design or drafting operation. The analysis portion of the software includes automatic calculation of perimeter, area, center of gravity, moments, radius of gyration and extent on any configuration. Database-management facilities support the Initial Graphics Exchange Standard. \$8,750. **Digital Equipment Corp.**, 146 Main St., Maynard, Mass. 01754, (617) 897-5111. **Circle 327**

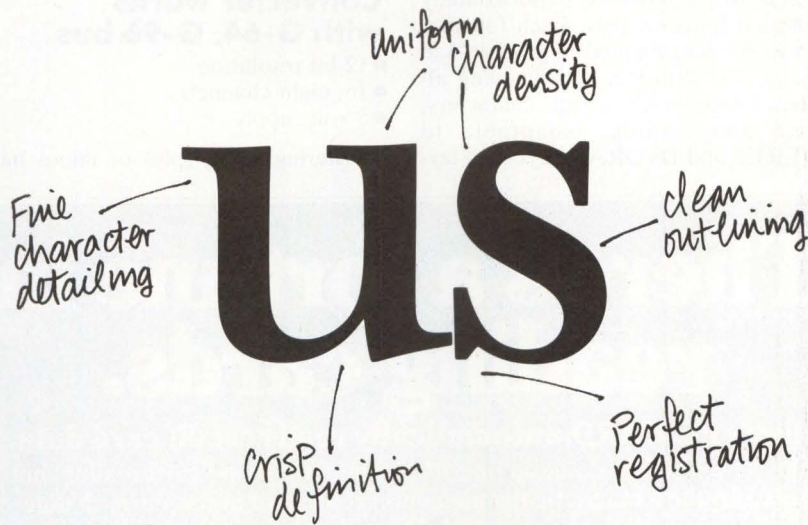
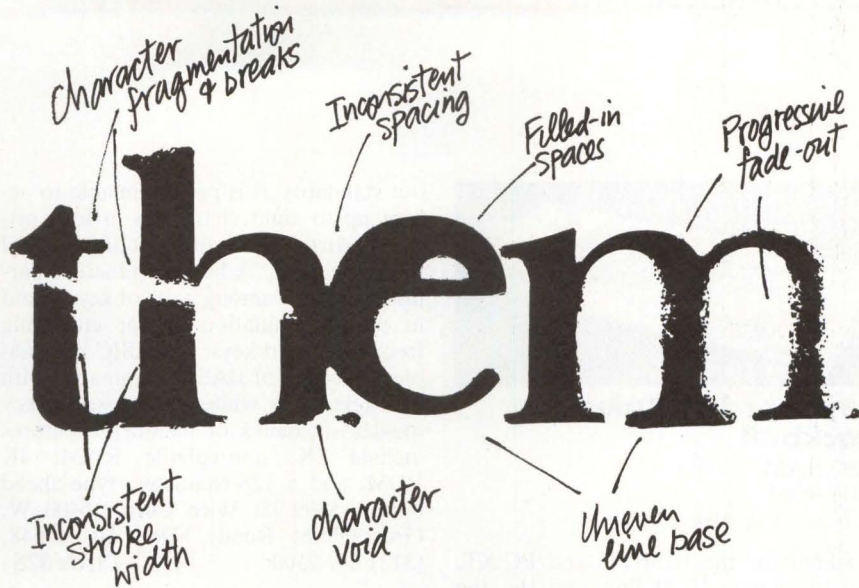

For letter-perfect printing every time, insist on authentic Qume multistrike ribbons and printwheels. Contact your supplies dealer or call (800) 223-2479 for more information.

Qume[®]
A Subsidiary of **ITT**



© 1985 Qume Corporation. Printed in U.S.A.

CIRCLE NO. 88 ON INQUIRY CARD



Keyboard includes trackball

- 2K RAM
- 4K ROM
- 10 function keys

Suited for the IBM PC and PC/XT, and the Apple II, II Plus and IIe, the combination SmartBoard intelligent keyboard and proprietary Smartball trackball allocates 252 bytes to 10 horizontally positioned function keys. Each function key can be programmed to contain 126 characters of information, including alphabet characters, control characters, spaces and returns. Adaptable to QWERTY and DVORAK keyboard lay-

out standards, it is programmable to accept up to eight characters in four primary directions and includes dual memory banks. A key-swap feature permits exchange among pairs of keys to aid in mouse emulation or for clustering frequently used keys. A BASIC key enables inputting of BASIC commands with two keystrokes while a mode-select key toggles six banks of memory. Features include 2K, non-volatile RAM; 4K ROM; and a 128-character, type-ahead buffer. \$399.95. **Wico Corp.**, 6400 W. Gross Point Road, Niles, Ill. 60648, (312) 647-7500. **Circle 328**

Converter works with G-64, G-96 bus

- 12-bit resolution
- 16, eight channels
- 5-volt supply

Offering 12-bit (plus or minus half a

bit) resolution, the GESADC-2 analog-to-digital converter conforms to the single-height, Eurocard form factor and is compatible with the G-64 and G-96 bus. Achieving a conversion time of 30µsec, the board accommodates 16 single-ended or eight differential channels. The unit is built around a hybrid analog module that incorporates an input multiplexer, input amplifier, sample and hold and a successive approximation converter. Equipped with a DC/DC converter, the board operates from a single 5-volt power supply and provides a floating analog power supply to the converter module. \$695. **Gespac Inc.**, Suite 11, 100 W. Hoover St., Mesa, Ariz. 85202, (602) 962-5559. **Circle 329**

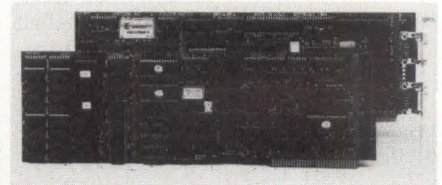

Controllers provide 16, 256 colors

- 68000 CPU
- IBM PC-compatible
- CAD/CAM applications

Drawing images at 1 million pixels per second, the M-16 and M-256 graphics controllers offer 16 and 256 colors, respectively, from a palette of 4,096. The controllers, employing the 68000 CPU, suit CAD/CAM/CAE, scientific-engineering, and business-presentation-graphics applications. Working with the proprietary 60-Hz, non-interlaced, model CD-1 RGB display, the controllers produce 640-by-480-pixel resolution. The units are IBM PC/XT- and PC-AT-compatible. \$2,250, M-16; \$2,850, M-256. **Verticom Inc.**, 545 Wedell Drive, Sunnyvale, Calif. 94089, (408) 747-1222. **Circle 330**

I/O board produces 64 colors

- Image processing
- 60-Hz input
- IBM PC-compatible

A video-frame grabber and display

There's a fortune in reading cards.

Alloy's PC-CARD automatically reads credit card data.

Alloy's PC-CARD is a hand operated magnetic stripe card reader that reads standard magnetically encoded credit card and security badge data into your IBM or compatible PC without using the keyboard.

Use PC-CARD for: Security access control. Password validation. Credit card sales and transactions. Data logging.

Make your fortune with the card reader from Alloy. Call (617) 875-6100 today.



Alloy Computer Products, Inc., 100 Pennsylvania Ave., Framingham, MA 01701, (617) 875-6100, TWX: 710-346-0394; Europe: Alloy Computer Products (Europe) Ltd., Cirencester, Gloucestershire, England, Tel: 0285-68709, Tlx: 43340

CIRCLE NO. 89 ON INQUIRY CARD

NEW PRODUCTS SUBASSEMBLIES



board for the IBM PC and PC/XT, the model DT2803 captures a 256-pixel-by-256-pixel-by-6-plane, black-and-white image. Its RGB output handles 64 colors by 64 intensities and includes cursor control. Combined with the proprietary Videolab software package, the board meets robotics, image-processing and graphic-arts requirements. Via RS170, 60-Hz or CCIRR, 50-Hz input signals, the board digitizes a video field every $\frac{1}{30}$ second. Captured images are converted at 5 MHz into 6-bit pixels, each pixel representing one of 64 possible gray levels. Four input look-up tables control color- and gray-level intensities. \$1,495. **Data Translation**, 100 Locke Drive, Marlboro, Mass. 01752, (617) 481-3700.

Circle 331

Disk emulator stores 2M bytes

- CP/M-compatible
- Parity checking
- Battery backup

A computer peripheral hardware and software disk-emulator package that increases computer-system operation rates, the SemiDisk stores 2M bytes and is expandable to 8M bytes. Acting as a disk drive, the board is compatible with the IBM PC, PC/XT and PC-AT; PC-compatible systems; the Epson QX-10 system; the S-100 bus and TRS-80 models II, 12 and 16. The standard driver software links into CP/M and CP/M B operating systems. Drivers are built into TP/M 3 and VALDOCS 2 operating systems. Features include arbitrary drive assignment, battery backup provision and parity checking. \$2,499. **SemiDisk Systems Inc.**, P.O. Box GG, Beaverton, Ore. 97075. (503) 642-3100.

Circle 332

MegaRam Disc Emulator

Revolutionary, Non-rotating,
Solid-state Replacement for
Fixed or Moving Head Discs.

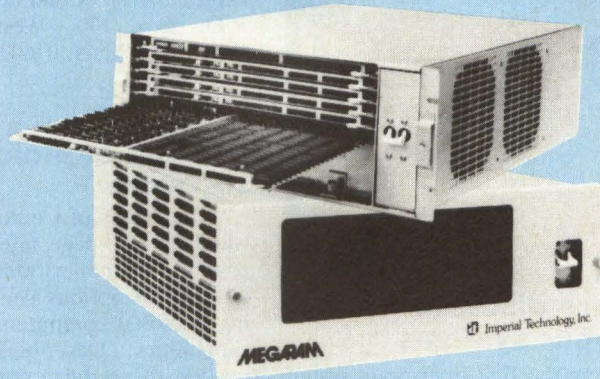

- Capacities from 2 megabytes to 40 megabytes in 2 megabyte increments.
- Up to 10 megabytes in a 7" chassis.
- Battery back-up.
- Streaming drive back-up in 7" chassis.

Advantages of The MegaRam Over Rotating Discs:

With no moving parts and easily replaceable sub-assemblies, the use of the solid-state MegaRam Disc Emulator assures dramatically increased performance and reliability. It further simplifies field maintenance.

Designed for use with the following computers:

- DEC • Data General • Sperry Univac (V77 Series)
- Hewlett Packard (HP1000 Series) • Modcomp
- SEL • CDC (System 17)

Replaces the Following Fixed Head Discs:

- DDC • Data Flux • Vermont Research
- Alpha Data

Typical Applications Include:

- Process Control • Mobile Equipment
- Telecommunications • Data Base Management
- Data Acquisition • Swapping Files • Automated Test Equipment • Graphics • Array Processors

Other configurations may also be available.
Please consult factory for information.



Imperial Technology, Inc.

831 S. Douglas Street • El Segundo,
California 90245 • Phone: (213) 536-0018

CIRCLE NO. 90 ON INQUIRY CARD

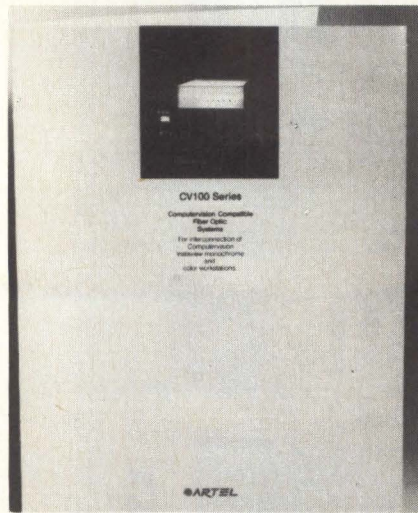

Brochure discusses fiber-optic systems

Describing the first fiber-optic system designed for Computervision Corp.'s Instaview color and monochrome CAD/

CAM workstations, the "CV100 Series" four-color brochure explains how the Artel fiber-optic systems replace coaxial and ribbon data cables used to interconnect the Computervision graphics processor and the Instaview workstations. The brochure discusses advantages of using fiber optics over coaxial and ribbon cables. **Artel Communications Corp.**, P.O. Box 100, West Side Station, Worcester, Mass. 01602, (617) 752-5690.

Circle 333

Booklet explains software

"The ABCs of Communications Software" is a 20-page reference guide that covers communications software and outlines the options available for expanding personal computer communications capabilities. Describing the hardware needed to establish communication between a personal computer and mainframes, minicomputers and other per-

sonal computers, the booklet discusses communication software capabilities, sending and receiving messages, modems, transmission speed, terminal emulation, text transfer and dialogue support. The booklet provides a glossary of 50 words and acronyms. **Software Synergy Inc.**, 466 Main St., New Rochelle, N.Y. 10801, (914) 633-0400.

Circle 334

Guide profiles public databases

A reference guide for comparing and selecting databases, the *Datapro Complete Guide to Dial-Up Databases* lists more than 1,400 publicly accessible databases in over 200 subjects, discusses 15 major on-line information services and reports on the latest technology affecting the industry. Arranged in alphabetical order by product name or acronym, each database profile provides a description and a name, address, telephone number and contact person of the organization that compiled the database, the type of organization, application emphasis, the scope of coverage, format of storage, frequency of updates, cost to the user, training, installation, documentation services and vendors. \$145. **Datapro Research Corp.**, 1805 Underwood Blvd., Delran, N.J. 08705, (800) 257-9406.

Circle 335

do you know!

INFORMATION ABOUT SAVING YOUR ELECTRONIC EQUIPMENT

Your Data Lines and Equipment are in Danger!

And they need protection...24 hours a day! At any time, in microseconds, your data lines, equipment and/or your data base, itself, can be destroyed.

The Cause High Voltage Transients. These destructive surges can be caused by lightning, power company switching, heavy machinery, etc. Directly coupled into a data line, these transients can cause immediate and cumulative damage to lines, sensitive equipment, or data base.

The Solution MCG Data Line Protectors. This mature, field proven family of protectors is expressly designed to guard signal/data/telephone equipment against transient overvoltage surges. The protectors interface between the data lines and the sensitive circuits to provide a sophisticated blend of high speed (5ns) voltage limiting and brute force protection. After each operation, they recover to a stand-by mode automatically.

MCG Data Line Protectors are designed for use with coaxial cable, single or twisted pairs, RS-232, -422 and -423, 20 ma loops and video lines.

Total Protection MCG provides the widest variety of data line protection devices available (protecting over 5,000,000 circuits to date). There is probably an existing model ideally suited to fulfill your particular need. So call or write today for cost effective insurance against data error and equipment downtime.



12 Burt Drive, Deer Park, NY 11729 • (516) 586-5125
Specialists in Circuit Protectors, Transients, Lightning & Surges.

Call or write for our **FREE CATALOG**



Directory details CAE software

A comprehensive guide for design and engineering professionals, *The PC Software and Systems Directory for Computer-Aided Engineering* specifies which software packages are available for which personal computers. The 82-page directory lists suppliers, applications, compatible hardware and prices of the software packages. Listings are cross-referenced by 20 different applications, such as integrated-circuit design, PCB design, 2-D drafting, 3-D design and solid modeling, as well as 28 types of systems, including IBM, IBM-compatible, Apple, DEC, HP and Wang personal computers. A 22-page matrix produces individual software packages available from more than 110 companies. \$79.00.

Management Roundtable Inc., 822 Boylston St., Chestnut Hill, Mass. 02167, (617) 232-8080.

Circle 336

The Computer Market:

We've taken control so you won't lose it.

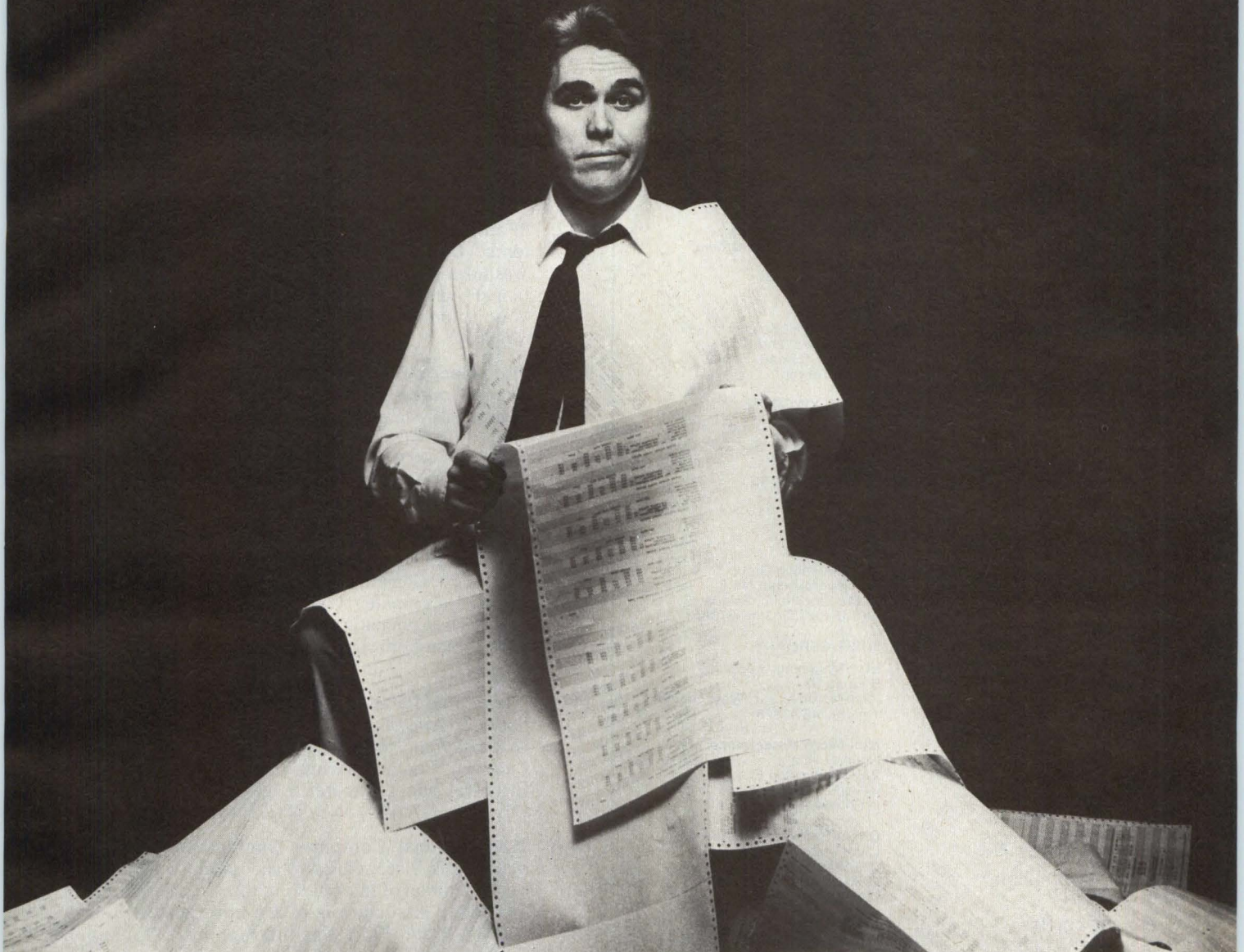

If the process of trying to reach the decision makers in the computer industry is overwhelming you with media data, start relaxing.

You do not have to buy space in every computer magazine published.

Cahners Publishing has developed a sophisticated *controlled* circulation system for its three computer publications which delivers the largest audience of documented buyers of computers and related products in business and industry.

Cahners computer publications guarantee you documented purchasing power, heavy passalong readership and over one million readers each month with minimum duplication.

Take *control* of your advertising dollars and reach the decision makers.



Sales Offices

Atlanta, (404) 955-6500; Boston, (617) 964-3030
Cherry Hill, NJ, (609) 751-0170; Chicago, (312) 635-8800; Dallas, (214) 980-0318; Denver, (303) 388-4511; Irvine, (714) 851-9422;
Los Angeles, (213) 826-5818; New York, (212) 686-0555; San Jose, (408) 243-8838;
Wayne, PA, (215) 293-1212.

CIRCLE NO. 92 ON INQUIRY CARD

Mini-Micro Systems

The leading magazine for computer professionals in the value-added market who integrate, configure and implement mini-micro computers and computer-based systems.

Business Computer Systems

The magazine for the buyers of business computers, peripherals, software, supplies and services for business applications—The Business Computer Management Team.

PC Products

The product review and evaluation magazine for the business users of IBM PC's and compatible computers.

Cahners Publishing Company

Publishers of 32 specialized business magazines in Building & Construction
Electronics & Computers Foodservice
 Manufacturing Medical/Health Care

REGIONAL SALES OFFICES

BOSTON

Robert K. Singer
National Sales Manager
Norma E. Lindahl
Assistant To The National
Sales Manager

John J. Fahey
Regional Manager
Katie Kress
Sales Coordinator
275 Washington St.
Newton, MA 02158
(617) 964-3030

PHILADELPHIA

Stephen B. Donohue
Regional Manager
1873 Route 70, Suite 302
Cherry Hill, NJ 08003
(609) 751-0170

ATLANTA

Larry Pullman
Regional Manager
6450 Powers Ferry Rd.,
Suite 170
Atlanta, GA 30339
(404) 955-6500

CHICAGO

Robert D. Wentz
Regional Manager
Marianne Majerus
Sales Coordinator
Cahners Plaza
1350 E. Touhy Ave.
P.O. Box 5080
Des Plaines, IL 60018
(312) 635-8800

DALLAS

Don Ward, Regional Manager
13740 Midway Suite 515
Dallas, TX 75234
(214) 980-0318

DENVER

John Huff
Regional Manager
270 St. Paul St.
Denver, CO 80206
(303) 388-4511

LOS ANGELES

Len Ganz
Regional Manager
12233 West Olympic Blvd.
Suite 236
Los Angeles, CA 90064
(213) 826-5818

ORANGE COUNTY

Debra Huisken
Regional Manager
2041 Business Center Dr.
Suite 109
Irvine, CA 92715
(714) 851-9422

SAN FRANCISCO

Frank Barbagallo
Northwestern Region Sales Manager
Rick Jamison
Regional Manager
Kathleen Maxwell
Sales Coordinator
Sherman Building, Suite 100
3031 Tisch Way
San Jose, CA 95128
(408) 243-8838

AUSTRIA

Elan Marketing Group
Neutor g. 2
P.O. Box 84
1010 Vienna, Austria
Tel: 43-222-663012 or -638461

BENELUX

Elan Marketing Group
Boschdijk 199B
5612 HB Eindhoven
The Netherlands
Tel: 32-40-455724

ISRAEL

Elan Marketing Group
13 Haifa St., P.O. Box 33439
Tel Aviv, Israel
Tel: 972-3-252967 or -268020
Telex: 341667

JAPAN

Kaoru Hara
General Manager
Trade Media Japan Inc.
R. 212 Azabu Heights
1-5-10 Roppongi Minato-ku,
106, Japan
Tel: (03) 587-0581

TAIWAN

Mr. Donald H. Shapiro
Trade Winds, 2nd Floor
132 Hsin Yi Road, Sec. 2
Taipei, Taiwan

UNITED KINGDOM

Elan Marketing Group
5th Floor, Suite 10
Chesham House
136 Regent St.
London W1R 5FA
Tel: 437-6900
Telex: 267653

SWEDEN

Elan Marketing Group
Humlegardsgatan Nr. 5
11446 Stockholm, Sweden
Tel: 46-8-677243 or -676243

WEST GERMANY

Elan Marketing Group
Sudring 53
7240 Norb/Neckar, West Germany
Tel: 49-7451-7828

Mini-Micro Marketplace

Norma Lindahl
275 Washington St.
Newton, MA 02158
(617) 964-3030

Direct-Response Postcards

Carol Flanagan
275 Washington St.
Newton, MA 02158
(617) 964-3030

Career Opportunities

Norma Lindahl
Recruitment Advertising Manager
275 Washington St.
Newton, MA 02158
(617) 964-3030

Cahners Magazine Division

J.A. Sheehan, President
William Platt
Executive Vice President
T.M. McDermott, Vice President
Electronics/Computer Group
Tom Dellamaria, VP/Production
Ira Siegel, VP/Research

Promotion Staff

Susan Rapaport
Marketing Communications Director
Mary Gregory
Promotion Manager
Liz Phillips
Promotion Assistant

Circulation

Denver, CO:
(303) 388-4511
Sherri Gronli
Group Manager

CALENDAR

JULY

- 8-12 "Foundations of Modern Telecommunications Systems" Course**, Washington, offered by the George Washington University Continuing Engineering Education Program. Contact: Shirley Forlenzo, George Washington University, Washington, D.C. 20052, (202) 676-8530.
- 9-12 "Knowledge-Based Systems and Artificial Intelligence Course,"** Los Angeles, offered by Integrated Computer Systems. Contact: Integrated Computer Systems, 6305 Arizona Place, P.O. Box 45405, Los Angeles, Calif. 90045, (800) 421-8166; inside California, (800) 352-8251. Also to be held July 23-26, Boston; July 30-August 2, San Diego.
- 10-12 World Computer Graphics '85 Exposition and Conference**, New York Coliseum, New York, sponsored by the World Computer Graphics Association and the National Computer Graphics Association. Contact: American Communications Group Inc., Suite 690, 8300 Greensboro Drive, McLean, Va. 22102, (703) 893-4545.
- 14-27 "Relational Database Machine Architecture" Seminar**, Les Arcs, France, cosponsored by Wayne State University and the NATO Advanced Study Institutes Program. Contact: Arun K. Sood, Department of Electrical and Computer Engineering, Wayne State University, Detroit, Mich. 48202, (313) 577-2150.
- 15-18 1985 National Computer Conference (NCC '85)**, McCormick Place, Chicago, sponsored by the American Federation of Information Processing Societies Inc. (AFIPS), Association of Computing Machinery (ACM), Data Processing Management Association (DPMA), IEEE Computer Society and Society for Computer Simulation (SCS). Contact: Cathy Shippert, AFIPS, 1899 Preston White Drive, Reston, Va. 22091, (703) 620-8926.
- 22-26 Summer Computer Simulation Conference and Exhibits**, Westin Hotel, Chicago, sponsored by The Society for Computer Simulation (SCS). Contact: Charles A. Pratt, SCS, P.O. Box 2228, La Jolla, Calif. 92038-2228, (619) 459-3888.
- 22-26 Siggraph '85: The Twelfth Annual Conference on Computer Graphics and Interactive Techniques**, San Francisco, sponsored by the Association for Computing Machinery's Special Interest Group on Computer Graphics in cooperation with Eurographics and the IEEE Technical Committee on Computer Graphics. Contact: Ellen Frisbie or Sheila Hoffmeyer, Conference Services Office, 111 E. Wacker Drive, Chicago, Ill. 60601, (312) 644-6610.

23-26 "Configuring Distributed Processing Systems" Course, Los Angeles, offered by Integrated Computer Systems. Contact: Integrated Computer Systems, 6305 Arizona Place, P.O. Box 45405, Los Angeles, Calif. 90045. Also to be held July 30-August 2, Washington.

AUGUST

5-8 "Digital Communications And Computer Network Systems" Course, Washington, offered by the George Washington Continuing Engineering Education Program. Contact: Shirley Forlenzo, George Washington University, Washington, D.C., 20052, (202) 676-8530.

7-9 National Computer Training and Education Conference and Exposition (COMTRED '85), Philadelphia Civic Center, Philadelphia, sponsored by National Computer Education Expositions Inc. (NCEE). Contact: NCEE, Suite 200, 1411 Walnut St., Philadelphia, Pa. 19102, (215) 972-8792.

13-15 Computer Graphics '85 East, Bayside Exposition Center, Boston, sponsored by the National Computer Graphics Association (NCGA). Contact: Chris Radiske, NCGA, Suite 601, 8401 Arlington Blvd., Fairfax, Va. 22031, (703) 698-9600.

26-29 Integrated Information Technology Conference and Exposition (INTECH '85), Moscone Center, San Francisco. Contact: Jill Nieman, National Trade Productions Inc., Suite 400, 2111 Eisenhower Ave., Alexandria, Va. 22314, (703) 683-8500 or (800) 638-8510.

SEPTEMBER

9-11 The Eighth Annual Federal Computer Conference, Washington, D.C. Convention Center, sponsored by the National Council for Education on Information Strategies. Contact: Dallas Kinney, Conference Communications, P.O. Box N, Wayland, Mass. 01778, (617) 358-5356.

16-20 FOC/LAN '85, The Ninth International Fiber Optic Communications and Local Area Networks Exposition, Brooks Hall/Civic Auditorium, San Francisco, organized by Information Gatekeepers Inc. Contact: Information Gatekeepers Inc., 138 Brighton Ave., Boston, Mass. 02134, (617) 787-1776.

OCTOBER

21-24 Computer Graphics '85, Atlanta, cosponsored by The World Computer Graphics Association and The National Computer Graphics Association. Contact: Christine A. Radiske or Holly Siprelle, NCGA, 8401 Arlington Blvd., Fairfax, Va. 22031, (703) 698-9600.

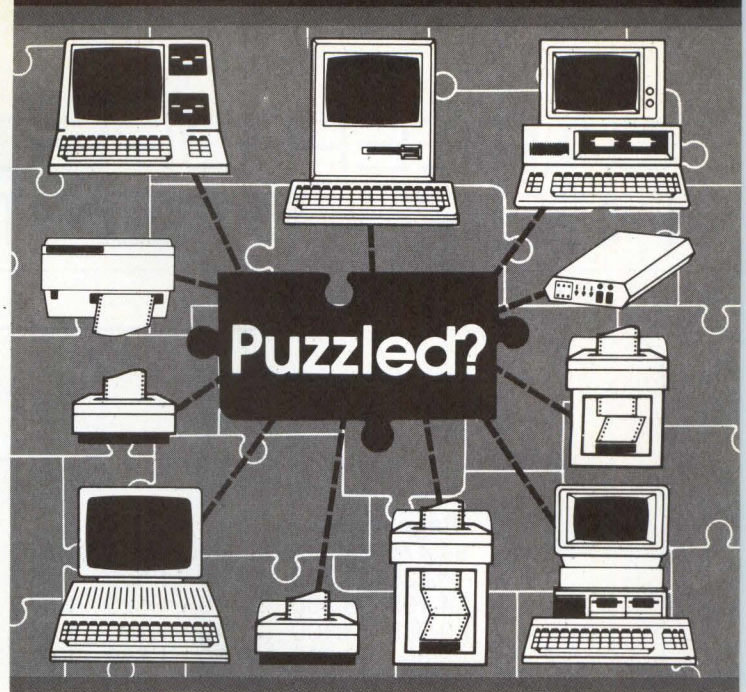

At last, there is an answer to your data communications puzzle . . . "THE PIPE"™ by Quasitronics.

"THE PIPE"™ is a new intelligent network controller that will solve your communications puzzle using your current hardware and software. Quasitronics' new controller has been specifically designed to piece together your puzzling array of microcomputers and peripherals.

"THE PIPE"™ connects up to 16 workstations or peripherals despite differences in transmission rate or protocol. And it fully supports RS-232, RS-422, and Centronics interfaces, all with equal ease. "THE PIPE's"™ expandability allows you to buy only the number of ports needed now and add extra ports later to meet your changing applications requirements.

"THE PIPE's"™ firmware controls all network links (one to one, one to many, or many to one) and communications parameters (baud rate, word length, parity, etc.). A 54k byte buffer is dynamically allocated for speed conversion, printer buffering, bulletin boards, private mail, and port data retention.

To learn how easily "THE PIPE"™ can solve YOUR communications puzzle, circle the reader service card or call toll-free 1-800/245-4192.

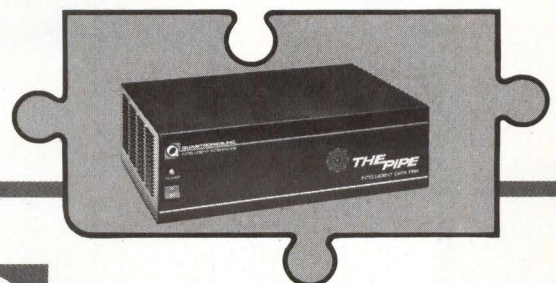

QUASITRONICS, INC.

211 Vandale Drive, Houston, PA 15342
412/745-2663 • Toll-Free: 800/245-4192

an Astrotech International Company

CIRCLE NO. 93 ON INQUIRY CARD

CAREER OPPORTUNITIES/ RECRUITMENT ADVERTISING

Rates

	Page	3/4	1/2	1/3	1/4	Col. Inch
1 x	\$4,475	\$3,425	\$2,340	\$1,750	\$1,170	\$120
3 x	4,235	3,300	2,245	1,690	1,105	110
6 x	4,105	3,200	2,175	1,625	1,075	105
9 x	3,985	3,100	2,110	1,575	1,040	100
12 x	3,850	3,005	2,050	1,560	1,015	95
15 x	3,735	2,915	1,985	1,510	980	85
18 x	3,590	2,800	1,910	1,495	950	80
24 x	3,525	2,750	1,875	1,430	925	75

Circulation

Over 130,000 technically sophisticated professionals in computer operations/systems management, data communications, engineering management, systems engineering/integrators, educators and systems programming specialists.

Recruitment
Hot Line

(617) 964-3030

Call your ad in—
we'll set the type
at no charge.

Mail Film to:

Norma Lindahl

Recruitment Advertising Manager

**Mini-Micro Systems
CAHNERS PUBLISHING CO.**
275 Washington St.
Newton, MA 02158

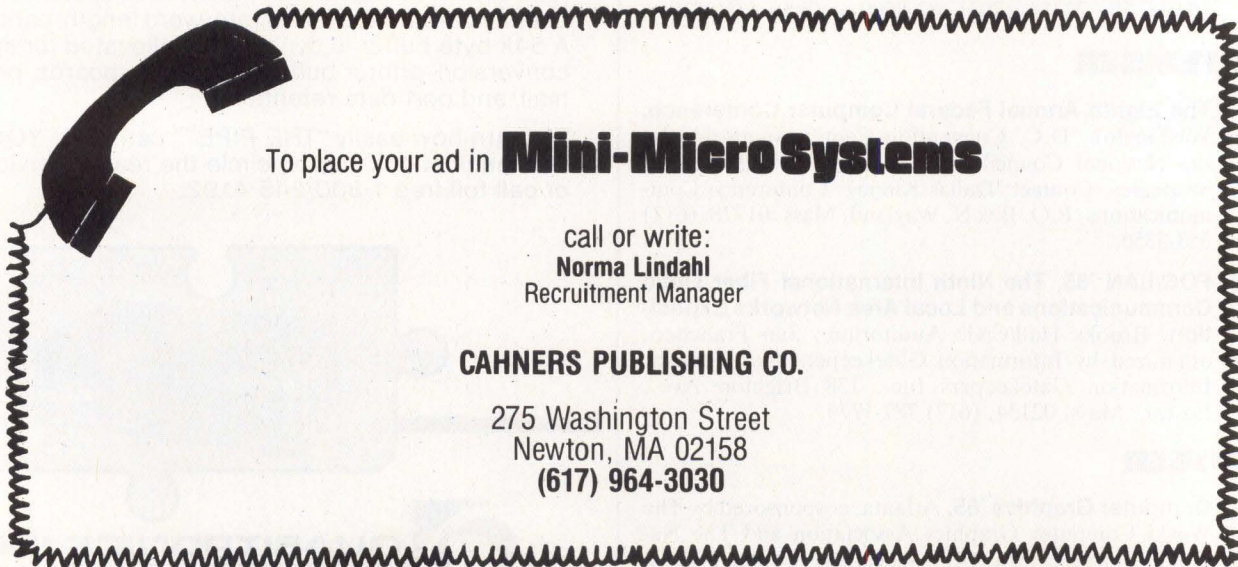

To place your ad in **Mini-Micro Systems**

call or write:
Norma Lindahl
Recruitment Manager

CAHNERS PUBLISHING CO.
275 Washington Street
Newton, MA 02158
(617) 964-3030

SOFTWARE ENGINEERS for Data Communications R&D — Join Racal-Milgo NOW in beautiful Ft. Lauderdale.

Racal-Milgo, one of the largest data communications companies in the world, has an enviable record of three decades of continuous growth. Our large, integrated network management systems are preferred by major Fortune 500 companies, the military, and government agencies.

Advanced software development... all of the current R&D "tools"... career growth... challenge... continuous learning... participation in decision making — they can all be YOURS when you join Racal-Milgo.

MULTIPLE OPENINGS AT MULTIPLE LEVELS — Fellow, Principal, Senior Software Engineers. Minimum requirements: MSCS degree and 3 years experience... or BSCS with 5 years... and developed skills in at least one of these disciplines:

- Communications Protocols
- Network Management System Software
- UNIX™ Operating System Kernel
- Real-Time Database Management
- Interprocessor Communication
- UNIX™ Tools and Utilities
- System Integrity/Fault Recovery
- System Testing

Racal-Milgo offers excellent salaries and complete company benefits, including 3 weeks of paid vacation, 100% paid tuition, life/medical/dental insurance, and a liberal relocation policy which includes MORTGAGE INTEREST DIFFERENTIAL.

For an interview, call Rebecca Larsen COLLECT: (305) 476-5448 — or send your resume to:

Racal-Milgo®

P.O. Box 407044 (13346) • Ft. Lauderdale, FL 33340

An EEO/Affirmative Action Employer UNIX is a trademark of Bell Labs.

Racal-Milgo employs over 3400 people. Our new 100-acre Harrison Park headquarters complex in Ft. Lauderdale provides an exceptionally attractive work environment.

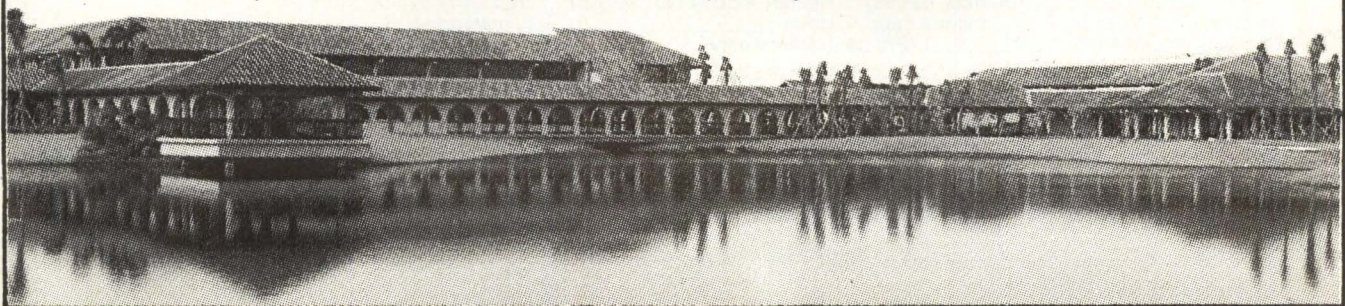

CIRCLE NO. 240 ON INQUIRY CARD

CLASSIFIED ADS

software

Z80 MADE E—Z

EZT, the most POWERFUL Z80* software debug tool available today for CP/M* systems features:

- Assembly Language Input.
- Disassembler.
- Direct Instruction Execution.
- Trace with Traps.
- Up to Seven Breakpoints.
- Search Mode.
- On Line Calculator.
- Binary, Octal, Decimal, Hex, ASCII.

\$29.95 includes complete 100 kbyte source program on diskette. Visa, MC, PO. or personal checks accepted.

TAYLOR MICRO TECHNOLOGY
1800 Mariposa Lane
Fullerton, CA 92633
(714) 773-4882

*registered trademarks of Zilog and Digital Research

CIRCLE NO. 225 ON INQUIRY CARD

Small ads do attract attention.

Contact: (617) 964-3030

software

PATENTS, TRADEMARKS and COPYRIGHTS

Software for filing complete applications for Design Patents, Trademarks and Copyrights. Computer generated forms, menu driven, information prompted. Just sign the forms and mail with required fee to the appropriate government office. Full documentation with Hot Lines. For IBM PC and Compatibles. Each program \$49.95; all 3 programs, \$99.95. Add \$5.00 for handling and shipping.

Send payment with order to: **PTC Forms, Steuben Drive, Jerico, NY 11753. Brochure available.**

CIRCLE NO. 226 ON INQUIRY CARD

inventions wanted

INVENTIONS, IDEAS, NEW PRODUCTS WANTED!

Presentation to industry. National Exposition.

Call: 1-800-528-6050, X831
ISC-MMS, 903 Liberty,
Pittsburgh, PA 15222

CIRCLE NO. 227 ON INQUIRY CARD

services

SOFTWARE DEVELOPERS

We have available time on an HP-3000 for your development and testing. Also we can provide you with a facility to demonstrate your product.

Our pricing is extremely reasonable at any level of resource requirement or length of commitment.

Located in the San Francisco Bay area, contact IER, Inc. at 415-968-2685.

CIRCLE NO. 228 ON INQUIRY CARD

miscellaneous

HEWLETT-PACKARD SOFTWARE DEVELOPERS & VENDORS

HP-3000 MAILING LIST

Available for purchase and/or rental, the best list outside of H-P! We have single and multiple rental pricing to suit your particular needs. Sub-sets by region, state and zip are available.

Contact us at: IER 415-968-2685

CIRCLE NO. 229 ON INQUIRY CARD

Copy Deadline: Call (617) 964-3030

Space reservations and advertising copy must be received by the 10th of the month preceding the issue date. Camera-ready mechanicals must be received by the

15th of the month preceding the issue date. For example, to appear in the February issue, copy must be received by January 10; mechanicals by January 15.

CLASSIFIED ADVERTISING ORDER FORM

Mini-Micro Systems classifieds reach more mini-micro people

Rates: \$90.00 per column inch (non-commissionable)
6x program earns 5% discount; 12x program earns 10% discount.

There is no charge for typesetting classified listings. Plan approximately 50 average words to a column inch, 8 lines of approximately 38 characters per line (3 inch maximum). Please send clean typewritten (double-spaced) copy.

Category: The following categories are available; be sure to specify the category you wish to be listed under: Business Opportunities, New Literature, Selling, Buying, Trading, Seminars, Services, Software, Supplies & Accessories. (Other categories may be employed at our discretion.)

Run this ad in _____ (number issues) Reader Inquiry No. YES NO
Ad size 1 col. wide by _____ inches deep Under _____ (category)
Check enclosed for \$ _____ (Pre-paid orders only)

Signature _____

Name _____ Title _____

Company _____ Telephone No. _____

Address _____

City _____ State _____ Zip _____

MAIL TO: Linda L. Lovett, Classified Advertising, Mini-Micro Systems,
Cahners Building, 275 Washington St., Newton, MA 02158

SYSTEM INTEGRATORS' NOTEBOOK

Tips that make dollars and sense

CREATE A LIMITED AREA NETWORK WITH RS232 PORTS, SWITCHES

Carl Warren, Western Editor

If you're planning on wiring together several systems or peripherals, you might want to consider a less-expensive alternative to local area networks: the RS232C "limited area network (LmAN)."

Unlike local area networks (LANs), which deliver data-transfer rates from 56K bits per second (bps) to 10M bps, LmANs operate at asynchronous serial speeds of 9,600 baud. Although relatively slow, 9,600 baud still delivers information in reasonable time. For example, a 10,000-character file transfers at 9,600 baud in slightly over 10 seconds, which is fast enough for common applications.

Another factor to consider when choosing between a LAN and a LmAN is the cost per connection. LAN connections range from \$200 to \$5,000, depending on the type of equipment. In contrast, a LmAN connection usually relies on the standard RS232C serial port found on most systems. Thus, the only hardware cost may be a serial cable with DB-25 connectors, which is available for less than \$100.

There are other costs associated with the LmAN, however. Typically, those costs are related to the type of extensions used (e.g., cables, switches, etc.), as well as to the complexity of the software.

You can extend the LmAN in a number of ways. On an IBM Corp. PC or similar system, you can add extra serial ports. The PC architecture allows up to two ports (COM1 and COM2), thus limiting the number of serial devices that can be attached. However, the serial ports can be ex-

tended to more than two devices by employing RS232C switches, which can be coupled together to form a matrix of devices.

RS232C switches typically come in two forms—dumb (manual) and intelligent—and range from two ports to as many as 16 ports. Thus, by adding switches, a single serial port can be extended to handle many devices.

Obviously, a manual switch isn't as convenient as an intelligent one because it requires human intervention and a detailed understanding of the network matrix. The typical intelligent switch allows defining attached devices by name, thus allowing access by simply requesting "printer1," for example. Multiple intelligent switches can be matrixed together to extend the network. As long as no conflicts in names exist, applications can get to any device on the matrix by name.

However, the software can be complex. Few application programs allow the proper passing of commands to a remote device from within an application. Examples of packages that do are Ashton-Tate's dBASE II/III and Framework.

Application programs such as MicroPro International Corp.'s Wordstar word-processing software will talk to just about any device if a special driver is incorporated in the user-defined function area. Thus, in print mode, you could pass an ASCII string by typing "PRINTERn," where n is the desired printer number somewhere on the LmAN matrix.

What's more, using intelligent RS232C switches allows you to use their built-in device commands for control. High-level languages such as

BASIC or Pascal can be employed to create the control program. In addition, you can create tailored files that use your LmAN matrix in different ways, and execute them as the application changes.

For systems that use MS-DOS, or a UNIX-like operating system that allows the creation of batch command files, you can be even more inventive. You could, for example, create a batch file that is a menu specifying a variety of devices and programs. This means that you would use the redirection functions of DOS to define a device.

Another method of creating a LmAN takes advantage of an intelligent add-in board on the system. For the IBM PC environment, the process is fairly simple. Numerous boards that provide 3270 emulation are available for the PC. Typically, these boards, such as the Emulex Corp. DCP88, provide asynchronous/synchronous ports, microprocessor control on the board and RAM for storing programs and data. Due to this extra onboard intelligence, these boards become ideal for creating LmANs.

Solved a hardware or software integration problem lately? If so, other *Mini-Micro Systems* readers would like to know about it. Please send your integration notes to Carl Warren, Western Editor, *Mini-Micro Systems*, Suite 236, 12233 W. Olympic Blvd., Los Angeles, Calif. 90064. (213) 826-5818, Ext. 307.

Interest Quotient (Circle One)
High 483 Medium 484 Low 485

ADVERTISERS INDEX

Alcatel Thomson Gigadisc	167	Mannesmann Tally	103
Alcyon Corp.	164	Maxtor Corp.	136
Alloy	62, 170	MCG Electronics	172
Altos Computer Systems	134-135	MDB Systems Inc.	16
American Federation of Information Processing Societies Inc. (AFIPS)	139	Megatek Corp.	107
Ampex Corp.-Computer Products Div.	108-109	Memory Products	120-121
Apollo Computer	42-43	Micro Data Base Systems Inc.	87, 143
Archive Corp.	68-69	Micro-Term	41
AT & T Electronic Photography & Imaging Center	91	Microware	56
Cambridge Digital Systems (Div. of Compumart)	166	Mini-Micro Systems	142, 163, 173
Canon U.S.A.	55	Mitsubishi Electronics America	129
Carroll Touch Technology	126	Multi-Tech	118
CCA/Uniworks Inc.	133	National Semiconductor Corp.	60-61
Charles River Data Systems	31	NCR Corp.	80-81
CIE Terminals	18-19, C3	Newbury Data	140
Compaq Computer Corp.	144-145	Nova Electric Manufacturing	132
Complete Management Systems (CMS)	72	Onyx & IMI Inc.	47
Computas	104	Output Technology	1
Control-C Software	62	Perkin-Elmer Corp.	12
CXI	100	Plessey Microsystems	149
Dataram	67	Quantum Corp.	74-75
Datasouth Computer Corp.	114	Quantum Software	5
Delta Airlines	119	Quasitronics	175
Digital Equipment Corp.	E2-E3	Qume	156-157, 169
Digital Sound Corp.	110	Rastor Technology	113
E + E Datacomm	79	RDS-Relational Database Systems	36-37
Electronic Processors Inc. (EPI)	82	Rodime	8
Emulex Corp.	28-29, 150-151	SBE Inc.	106
Facit Inc.	122	Shape Magnetronics Inc.	4
Flexible Computer	99	Siggraph	130
Fujitsu America Inc.	35, 88	Storage Technology	6-7
General Power	59	SyQuest Technology	117
Genicom	10-11	Tab Products	73
Hayes Microcomputer Products	20-21	Techtran Industries	168
Hewlett-Packard	52	Televideo Printers	76
Houston Instrument Div. of Bausch & Lomb	84	Televideo Terminals	159
Human Designed Systems Inc. (HDS)	92	Texas Instruments	70
Imperial Technology Inc.	171	Unify Corp.	94-95
Integrated Digital Products Corp.	125	Universal Data Systems	C4
Interface Group	161	Vectrix	152
Interphase Corp.	32	Verbex	96
Iomega Corp.	22	Western Telematic Inc.	165
Irwin Magnetics	155	Wyse Technology	50-51
JDL	49		
Keytronic	146	See p. 178 for Classified Advertisers	
Kierulff Electronics	44	See p. 176-177 for Career Opportunity Advertisers	
Lear Siegler Inc.	38	See p. 183-184 for Mini-Micro Marketplace	
Macrolink	15		

This index is provided as an additional service. The publisher does not assume any liability for errors or omissions.

MARKET TRACK

Sharon Hassell
Assistant Editor

Hard-copy graphics market to reach \$12.3 billion

The hard-copy graphics market—consisting of plotters, printers and camera systems—will be worth \$12.3 billion in 1990, according to a recent study by Venture Development Corp. (VDC), Natick, Mass. The 1990 figure represents a 78 percent increase over the 1984 market.

According to VDC, camera systems will be the fastest growing product segment of the hard-copy graphics market. Representing 2.1 percent of the market in 1984, camera systems including entry-level graphics, presentation graphics and commercial graphics will claim 10.7 percent of the 1990 market. Of the four types of camera systems, entry-level graphics will experience the most dramatic growth says VDC. Plotters, including drum, fixed-

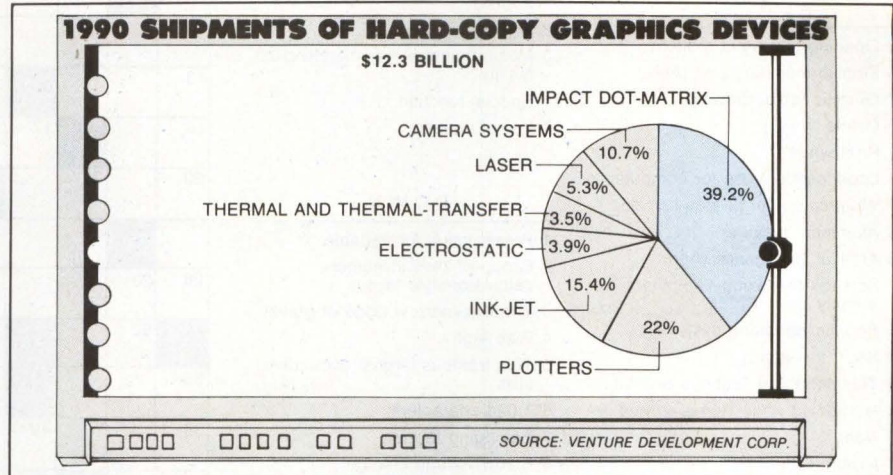

and moving-media flatbed devices, are expected to be the second fastest growth segment of the market.

Although camera systems and plotters will show the highest growth rates through 1990, graphics printers will continue to dominate the hard-copy graphics market. In 1984, impact dot-matrix graphics printers captured 59.8 percent of the market. In 1990, impact

printers' 39.2 percent share will still lead the market, but by a smaller margin.

The VDC study forecasts shipments in units and dollars through 1990 and profiles hard-copy graphics users. The study also gives industry background, a product and technology discussion, recommendations for competitive strategies and vendor profiles. □

Computer graphics boost art, design and drafting techniques

Computer graphics for art, design and drafting will become a mass market between 1985 and 1990 according to consulting company Davis Inc., Washington. Results of a recent Davis study indicate that by 1990, over 20 percent of all artists, designers and draftsmen will regularly use computer graphics to produce commercial art.

The end product in art, design and drafting, traditionally evolves from idea to finished form through a sequence of steps involving paper, pens, templates, transfer lettering and mounting boards. This creative evolution requires highly developed manual skills as well as expertise with low-technology transfer equipment such as photostat cameras.

In the past, these transfer functions proved easier to automate than did the

more creative steps in art and design. However, according to Davis, it is now more cost-effective to execute, store, process, transport and deliver visual information in a digital, computer graphics form than to use traditional creative methods and materials.

Davis says the shift toward increased use of computer graphics will affect art, design and drafting in several important ways. For example, mechanicals for transparencies will become computer graphics titles, charts, tables, diagrams, illustrations and special effects, and archives of maps and engineering drawings will become electronic databases for facilities and products. Press type, stock visuals and plastic templates will become digital typography, symbol and image libraries and electronic design and drafting func-

tions; typesetting, layout and paste-up will become electronic page makeup and image setting; and copy stands and photostat cameras will become solid-state cameras, scanners, computer-data replication and image processing.

According to the study, computer graphics technologies will first assist and then displace conventional methods of generating, changing, converting and distributing art, design and drafting products. Davis says the trend is toward low-cost computer graphics workstations that meld the features of audiovisual, print/publishing, architectural, engineering and design applications and provide capabilities to link personal workstations with remote production and distribution systems.

Interest Quotient (Circle One)
High 486 Medium 487 Low 488

ARTFUL INTELLIGENCE

By John K. Young

ACROSS

- 2 Opening to plug in modem
- 5 Finnish monetary unit (Abb.)
- 7 Graphic tablet drawing
- 9 Delete
- 11 Print wheel
- 13 Label scoffers use for computer
- 14 What computer pirates can do
- 15 Aluminum (Chem.)
- 16 Artificial intelligence (Abb.)
- 17 Science of making computers friendly
- 20 Popular operating system
- 22 Short for Albert
- 23 This John is a fictitious plaintiff
- 24 He fiddled while Rome burned
- 26 Near
- 27 Iridium (Chem.)
- 28 Interlocking repeating patterns
- 32 When it is
- 33 To port (Abb.)
- 34 Member of a people living in Latvia
- 35 Station (Abb.)
- 36 Male hacker
- 37 Capital of Norway
- 39 Computer accessory
- 43 Input/output (Abb.)
- 44 Lawrencium (Chem.)
- 45 Group formed to help computer beginners
- 46 Lowest ranking noncommissioned officer (Abb.)

- 47 Ancient Hebrew dry measure (Plural)
- 48 Slip
- 50 Multiterminal screen-handling facility
- 51 Special function
- 52 List of options

DOWN

- 1 Preset value for variable
- 2 Group of keys in numeric calculator-style layout
- 3 Winding, narrow ridge of gravel
- 4 Rise high
- 5 This frame is largest computer size
- 6 1,024 characters
- 7 Belonging to me
- 8 Sharp voltage change
- 10 Shower
- 11 Popular Broderbund game on disk
- 12 Schol half-year (Abb.)
- 15 British microcomputer
- 17 One's divorced spouses
- 18 British slammers
- 19 Very foolish persons
- 21 Stage of an insect between molts
- 25 Fell back into bad habits
- 26 One who bundles hay
- 29 Restaurant customer
- 30 Suffix used in forming names of certain alcohols

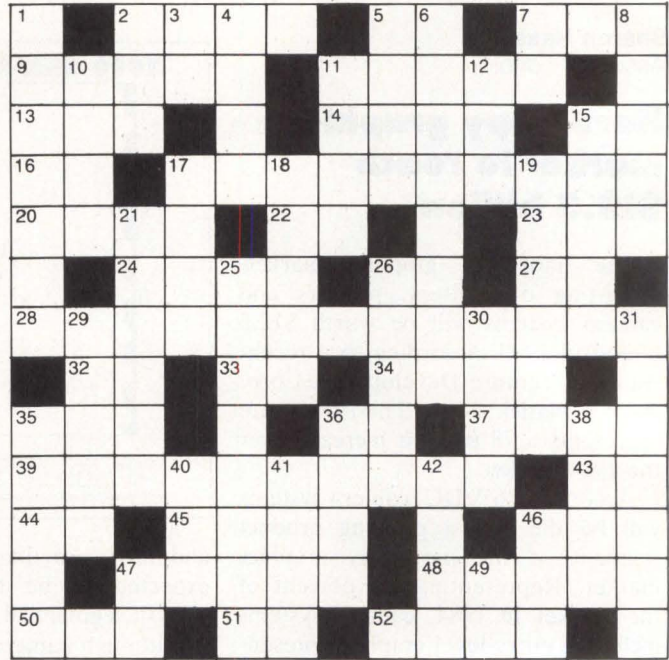

- 31 Programs that stores printer-directed characters
- 35 This kind of screen represents up-to-the-minute enhancement
- 36 Belonging to that girl
- 38 One smacks them to express great satisfaction
- 40 Suffix used in forming names for chemical elements
- 41 Heath robot
- 42 Manufactures Q-bus- and Unibus-compatible products
- 46 Heart of microcomputer
- 47 Word of affirmation intoned as part of mantra
- 49 A single

Y G U B E D D O S E A O C I
 R V A R E L E T T E S S A C
 O S K D E E P S C K R L I I
 M L O C G I L I B E S S U H
 E C C A A F H U M Y A I A P
 M R M H E P Y M D B T R D R
 R E W O A S A S T O R E I O
 E T D R P R N T A A M D N C
 T N G O G N A A A R T R E E
 N I E O M O L C A D C O P S
 I R R E L L O R T N O C O S
 O P N I K N G V I E D E R O
 P L K E V E I R T E R R T R

Analog	Datapack	Kilo	Programmers
BASIC	Debug	Memory	Pulse
Bug	Disk	Mode	Recorder
Byte	Field	Modem	Retrieve
Cassette	Game	Module	Speed
Character	Graphic	Pointer	Store
Code	Icon	Port	Tree
Controller	Key	Printer	VAR
Data	Keyboard	Processor	

Solution will be printed next month.

Answers to May's puzzles
 can be found on Page 168.

Interest Quotient (Circle One)
 High 489 Medium 490 Low 491

MINI-MICRO MARKETPLACE

A special section for advertisers of hardware, software and services.

Please circle reader service numbers for additional information.



"OL' RELIABLE"

Year after year, DP managers and field engineers rely on Texwipe TEXPADS. And with good reason—these disposable presaturated pads remove oxide, dirt and other harmful contaminants from tape transport heads and components safely AND reliably.

Send for FREE samples and catalog.



The Texwipe Company

650 East Crescent Avenue • P.O. Box 308
Upper Saddle River, NJ 07458
(201) 327-9100 • Telex 130370

CIRCLE NO. 200 ON INQUIRY CARD

IBM PC TAPE BACKUP



- Cipher 5210 Subsystem
- 25MB (formatted) capacity
- Menu Driven Software
- No Additional Card
- \$1025⁰⁰ with 6 mos. warranty

Available From:

Microware Inc.

41711 Joy Road • Canton, MI 48187
(313) 459-3557

CIRCLE NO. 201 ON INQUIRY CARD

ZX-5000™ EXTENDED RANGE™ SURGE SUPPRESSORS

The ZX-5000 Extended Range series surge suppressors provide the most advanced protection available on the market today against spikes, surges and noise disturbances.



UL LISTED

SUTTON DESIGNS INC.
COMPUTER SECURITY DIVISION
300 North Tioga • Ithaca, NY 14850
607-277-4301

CIRCLE NO. 202 ON INQUIRY CARD

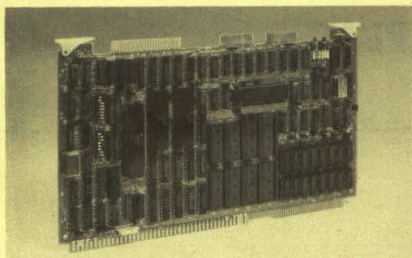

10 MHz Z8000™ PERFORMANCE

In addition to 10 MHz, the NEW MBx8000 SBC features a single width SBX connector for adding standard expansion modules, such as the SBSxFDC Floppy Controller. MBx8000 maintains all the capabilities of its predecessor, the MB8000: Z8001/Z8002 CPU 4/6/10 MHz; 32K/128K/512K DRAM; up to 48K static RAM or EEPROM; up to 128K EPROM; 2 RS-232 ports; 40 parallel I/O lines; six 16-bit counter-timers; etc. Z8000™ Zilog. SINGLE BOARD SOLUTIONS, 7669 Rainbow Drive, Cupertino, CA 95104. (408) 253-0181

CIRCLE NO. 203 ON INQUIRY CARD

for Serious Software Developers

TARGET MICROPROCESSORS

80286, 8086/80186, 8096, 8080/8085, 8051, 8048, Z8002, Z80, Z8, NSC 800, 9900, 68000/08/10, 6809, 6800/01/02, 6805, 6301, 6305, 6500, G65SCXX, G65SC1XX, R65C00, R6500/1, and others.

HOST COMPUTERS

DEC VAX, PDP-11, DG MV-Series, DG Eclipse, Apollo, UNIX Systems, IBM PC, Data General/ONE, HP 150, DEC Rainbow and others.

SOFTWARE TOOLS

C Compilers, Pascal Compilers, PLM Compiler, Assemblers, Linking Loaders, Librarians, Download, Communications, VT-100 Emulator, CPM/80 Emulator.

If you are a serious software developer, shopping for software development tools, call or write today for more information. 800-551-5554 in CA call (408) 733-2919



**MICROTEC®
RESEARCH**

3930 Freedom Circle, Suite 101, Santa Clara, CA 95054
Mailing Address: P.O. Box 60337, Sunnyvale, CA 94088
(408) 733-2919 Telex (ITT) 4990808

CIRCLE NO. 204 ON INQUIRY CARD



NEW DIGITAL TEMPERATURE TESTER MODEL 383

Complete temperature tester in one compact hand-held instrument. Features include 3" display, dual type J thermocouple inputs, differential/normal temperature mode, DC millivolt range, analog output. All these features and more in this unique instrument. Unit is supplied with 2 type J glass-braided thermocouples, test lead kit, 9v battery, and operator's manual. For more information, call 203/359-7613 or write Omega Engineering, One Omega Drive, Box 4047, Stamford, CT 06907.

CIRCLE NO. 205 ON INQUIRY CARD

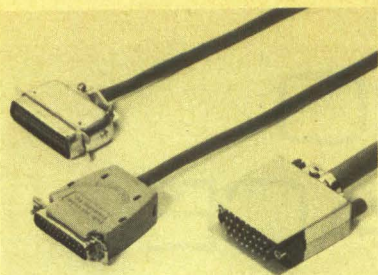

EIA AND 200 OTHER INTERFACE CABLES – Call on Data Set Cable for all types of cables and connectors, many in stock for immediate shipment . . . or order pinned to your specifications: ribbons, coax, twin-ax, TELCO, compatibles for IBM, DEC, H-P . . . to name just a few. EIA RS-232C cables – 25 conductors, all connected, \$16 plus 50¢/ft. Send for catalog. **Data Set Cable Co.**, 722 Danbury Road, Ridgefield, CT 06877 – (203) 438-9684. Also Las Vegas – (702) 382-6777.

CIRCLE NO. 206 ON INQUIRY CARD

IBM AT 3Mb COMBO CARD WITH LIFETIME WARRANTY*

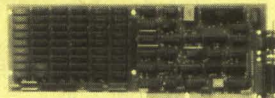

The AT Multifunction Card that can give you up to 3Mb of added memory plus added I/O features.
Expandable from 128K to 3Mb. Add memory as you need it. • IBM AT Compatible • Parallel Port • Serial Port • Spooler • Supports IBM VDISK • User Upgradable • Parity Checking Standard • Split Memory Addressing.
Complete with 128K RAM, Serial and Parallel Port \$449
AT RAM Expansion Card (9K) \$129
Additional RAM available at our low prices. **OTHER ADD ONS** 384K RAM/ Clock, 512K RAM Card, Spoolers, RAM Cards for PPCs and more.



4401 So. Tamarac Parkway / Denver, CO 80237 / 303-741-1778
ORDERING AND DEALER INFORMATION
800/525-7674
Stores in Denver & Chicago / *On all cards sold after June 1, 1984

CIRCLE NO. 207 ON INQUIRY CARD



8086 Software Development Tools That Don't Pin You Down

Tools
Compilers for Pascal, C, FORTRAN, and PL/M. Assemblers, Linkers, Locaters, Librarians, Downloaders and Communications, UNIQUE HIGH LEVEL LANGUAGE CROSS DEBUGGER, Support for VRTX™, MTOS™, RMX™

Targets
8086/80186/8088/80188/8087. 8080/8085/280/NSC 800.

Hosts
DEC VAX/VMS™, DG MV/Family, HP 9000/500 HP-UX.

For advanced tools that get your job done faster and reduce your costs, call (213) 546-5581 today.

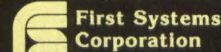

865 Manhattan Beach Blvd., Manhattan Beach, CA 90266.
(213) 546-4861. Telex (RCA) 298086.
™: Digital Equipment Corp. DEC, VAX, VMS. Hunter & Ready. VRTX. Industrial Programming: MTOS, Intel, iRMX.

CIRCLE NO. 208 ON INQUIRY CARD



THE RSX/VMS SPECIALISTS

THE LSI-11/73 BASED CM-300/Q22 COMPUTER SYSTEMS WITH RSX-11M+ SUPPORTING SUPERVISOR MODE LIBRARIES AND SEPARATE I AND D SPACE

THE MICRO-VAX I BRINGS VAX POWER AND HIGH PERFORMANCE TO THE Q-BUS

CM-300/Q22 computer systems are configured with DEC's LSI-11/73 CPU, giving these systems 11/70 PERFORMANCE AT LSI-11 PRICES. CM-300/Q22 systems can be configured with up to 1200MB of fixed Winchester disk, up to 4MB of main memory and up to 64 terminals. System back-up is provided by an industry standard 9 track 1/2" 1600 BPI tape drive. Optional software packages include Automatic Date/Time for RSX, Memory Assisted Disk, Cached Pseudo Disk, Memory Dump, Mail List, RSX, accounting software, FORTRAN 77, FMS-11, BASIC +2 and DATATRIEVE. An LSI-11/73 based 300MB system including RSX-11M+ license, media and documentation, with a VT220 terminal may be purchased for \$23,033.

MICRO/VAX I computer systems can be configured with up to 4MB of main memory, up to 31MB of fixed disk and up to 5 terminals. Prices start at \$13,740.

Call A.C.S. and let us configure a hardware/software solution for your specific problems.

ADVANCED COMPUTER SYSTEMS, Inc. 250 Prospect Street
Waltham, Massachusetts 02154
617-894-3278

CIRCLE NO. 209 ON INQUIRY CARD

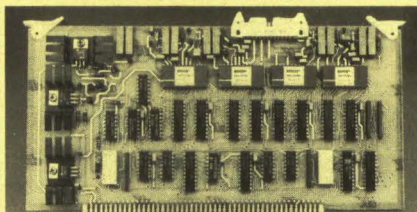

16 Bit/4 Channel D/A Board

The high resolution IEEE-696 test, measurement and control solution.

- Address channels individually or in any combination.
- Switch selectable 8 or 16 bit addressing.
- Power on initialization to one of two switch selectable reference levels.

NE Nathaniel Electronics P.O. BOX 51, NEW HAVEN, VT. 05472
phone: (404)-438-3998

CIRCLE NO. 210 ON INQUIRY CARD

Promote New Literature at a LOW COST

If you've got catalogs or literature, distribute them at a low cost in the MINI-MICRO MARKETPLACE.

Call Norma Lindahl
(617) 964-3030

CIRCLE NO. 211 ON INQUIRY CARD

ORDER FORM

Advertise in the **MINI-MICRO MARKETPLACE**
Please run my advertisement in the following issues

EFFECTIVE JANUARY 1985

1x	3x	6x	12x	18x
\$660	\$595	\$575	\$560	\$545
	24x	48x		
	\$525	\$505		

MATERIALS

- Glossy photo with 50-75 words.
We will typeset your ad at no charge.
- Camera ready artwork.
- Film negatives: right reading emulsion side down.

AD SIZE: 2 1/4" x 3 1/16"

COMPANY _____
ADDRESS _____
CITY _____ STATE _____ ZIP _____
TELEPHONE _____
SIGNATURE _____

Space reservation by the first week of the month proceeding issue date.

- Materials enclosed Materials to come Please send information

Send to: Norma Lindahl, **MINI-MICRO SYSTEMS**
275 Washington St.
Newton, MA 02158

15% Agency commission to accredited agencies. Please specify agency.

The terminal
on the right
outperforms the
competition.
And costs less.

The computer
on the left
doesn't care
about
the price.

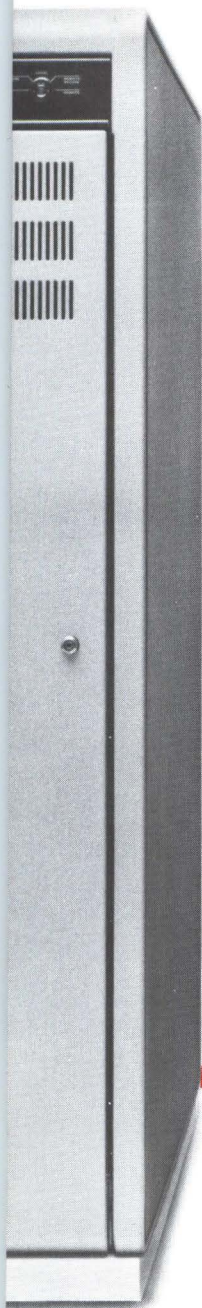

A computer is born to perform. No matter what the price.

You, however, have practicalities to think about. Making your computer perform the way it's meant to is one. Watching costs is another. And you have to blend the two to create the most valuable, cost effective system possible.

CIE Terminals has a video terminal that'll make you both happy. The CIT-220+.

It's a remarkably reliable piece of technology that years to show its stuff as much as the computer it's hooked up to. Something they'll both get plenty of chances to do. That's because the 220+ is so reliable, it's always up and running. Which



means your computer is, too.

The 220+ is compatible with the DEC VT220. But it's not comparable. That's where the plus is. You'll find no less than 20 improvements and additions that make the most of your computer.

And because the 220+'s price is in direct contrast to its high performance, you get the best value for your money. So although the computer doesn't care about the cost, you don't have to think about it, either. For more information on the CIT 220+, contact your distributor or CIE Terminals at 2505 McCabe Way, Irvine, CA 92714-6297 (800) 624-2516.

CIE TERMINALS
A C/TOH ELECTRONICS COMPANY

Because your computer is only as good as its peripherals.

© 1985 CIE Terminals

CIRCLE NO. 94 ON INQUIRY CARD

FULL DUPLEX

224

SYNCH/ASYNCH



2400/1200 bps for dial-up data communications

UDS reliability and cost effectiveness are now available in a fully digital, microprocessor-based 2400 bps full-duplex modem!

Our model 224 meets V.22bis specifications for synchronous or asynchronous operation. Its communications efficiency is further enhanced by WECO-compatible fallback capability to 1200 bps (212A). The ANSWER data rate is switch selectable from the front panel; for maximum communications flexibility, the ORIGINATE unit automatically senses the ANSWER modem's setting and transmits at that rate.

The UDS 224 is compatible with 2400 bps, full-duplex modems from most other manufacturers for operation over two-wire dial-up or dedicated telephone circuits. Packaged as a free-standing, desk-top device, it supports either permanent or controlled auto answering.

For detailed specifications and quantity prices, contact your nearest UDS Sales Office or Distributor. Universal Data Systems, 5000 Bradford Drive, Huntsville, AL 35805. Telephone 205/837-8100. Telex 752602 UDS HTV.

QUANTITY ONE PRICE
\$645



Universal Data Systems

 **MOTOROLA INC.**
Information Systems Group

Inquiry Hotline: 800/633-2252, ext. 372

UDS modems are offered nationally by leading distributors. Call the nearest UDS office for distributor listings in your area.
DISTRICT OFFICES: Atlanta, GA, 404/998-2715 • Aurora, CO, 303/368-9000 • Blue Bell, PA, 215/643-2336 • Boston, MA, 617/875-8868 • Columbus, OH, 614/895-3025 • East Brunswick, NJ, 201/238-1515 • Glenview, IL, 312/998-8180 • Houston, TX, 713/988-5506 • Huntsville, AL, 205/837-8100 • Issaquah, WA, 206/392-9600 • Mesa, AZ, 602/820-6611 • Minnetonka, MN, 612/938-9230 • Mountain View, CA, 415/969-3323 • Richardson, TX, 214/680-0002 • St. Louis, MO, 314/434-4919 • Silver Spring, MD, 301/942-8558 • Tampa, FL, 813/684-0615 • Thousand Oaks, CA, 805/496-3777 • Tustin, CA, 714/669-8001 • Willowdale, Ont, Can, 416/495-0008 • Ypsilanti, MI, 313/483-2682

CIRCLE NO. 95 ON INQUIRY CARD

Created by Dayner/Hall, Inc., Winter Park, Florida