

THE ELECTRONIC ENGINEER

a CHILTON publication / August 1972

Digital readouts course—Part 2
Sorting out the display technologies

Data communications feature:
Designing a minicomputer into your system

Packaging with ICs course—Part 6
Get that certificate by passing the exam

HOW MUCH DEFENSE IS ELECTRONICS?

Carlson of Sprague Electric throws a curve

30

20

10

9

8

7

1

0

5

10

PLUS
DATA
COMMUNICATIONS





Crystalonics FET analog gates in a steel plant?

That's right.

The best doesn't cost any more anymore.

Many of the heavy duty electrical controllers used in steel mills and other computerized industrial processes still use reed relays and associated driver circuits to interface with the computer logic circuits. *Our* controller customers have switched to FET analog gates, because the gates are 1000 times faster than reeds, last far longer, require less power, and operate directly from computer logic. The performance and life of their controllers are greatly improved, and the overall costs are comparable.

Crystalonics FET analog gates are also upping performance and holding the line on costs in TV studios, telephone multiplexers, automatic testers, oceanographic research equipment, programmed lighting controls, input/output multiplexers for computers, medical electronics equipment, music synthesizers, and audio recording studios.

Let our applications engineers help you to apply today's solid state technology to *your* needs. Crystalonics' 13 years of technological leadership in solid state switches, fotofets, and varactors is available *now*, off the shelf, and the best doesn't cost any more anymore.

Send now for our new catalog of Industrial Switching ICs to Teledyne Crystalonics • 147 Sherman Street • Cambridge, Mass. 02140 • Phone: 617-491-1670.

 **TELEDYNE**
CRYSTALONICS

CRYSTALONICS SALES REPS AND AGENTS

U.S. & CANADA: (201) 835-0332 / (203) 932-5656 / (205) 883-0140 / (206) 454-7422
(213) 466-6201 / (213) 469-5871 / (214) 231-6891 / (216) 221-0450 / (219) 485-0805
(301) 823-3603 / (303) 771-4920 / (305) 622-1383 / (312) 359-9599 / (314) 542-3657
(315) 458-4775 / (319) 363-6425 / (415) 964-5454 / (505) 268-0928 / (513) 299-4144
(514) 684-7755 / (516) 593-2628 / (602) 273-7387 / (609) 983-6660 / (612) 488-0201
(617) 731-0858 / (716) 342-1413

OVERSEAS: AUSTRALIA - 790-22846 / BELGIUM - 846-21169
DENMARK - 855-5052 / ENGLAND - 851-23894 / FINLAND - 857-121676
FRANCE - 842-62193 / GERMANY - 841-524506 / HOLLAND - 844-54512
ITALY - 843-34424 / JAPAN - 781-4419 / NORWAY - 856-18625
SWEDEN - 854-10338 / SWITZERLAND - 845-52042

Circle Reader Service #1

G P

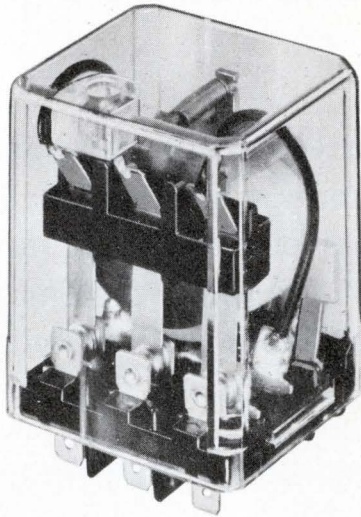

MAGNECRAFT'S NEW CLASS 388 GENERAL PURPOSE RELAY

Magnecraft is pleased to introduce the new Class 388 General Purpose Relay. This inexpensive, high performance line of stock relays offers many quality features found only in custom built versions. Available in either a covered plug-in or open style with a wide choice of AC or DC coil voltages and SPDT, DPDT, or 3PDT 10 amp contacts.

All Class 388 relays have 3-way pierced terminals. While spaced for standard plug-in mounting, the flat terminals (0.187" x 0.020") also accept quick-connect receptacles or direct soldering. For plug-in use, three types of chassis mounted sockets are available; quick-connect, solder, or printed circuit terminals. Covered plug-in version has a tough clear polycarbonate plastic cover.

In a highly competitive business, delivery can be a deciding factor. If delivery is important to you, be aware that Magnecraft ships better than 90% of all incoming orders for stock relays, received before noon, THE SAME DAY (substantiated by an independent auditing firm). In addition to our shipping record, most stock items are available off-the-shelf from our local distributor.

FREE!



DESIGNER'S CATALOG

The purpose of this 36-page catalog is to assist the design engineer in specifying the proper relay for a given application. The book completely describes General Purpose, Sensitive General Purpose, and Mechanical Power Relays. New products include the complete line of Class 388 General Purpose Relays.

Magnecraft[®] ELECTRIC COMPANY

5575 NORTH LYNCH AVENUE • CHICAGO, ILLINOIS 60630 • 312 • 282.5500 • TWX-910.221.5221

Sensitivity 10 mV

Stabilities to ± 5 parts in $10^{10}/24$ hrs.

Battery option

\$770 up, delivery 30 days

All models frequency expandable
Resolution to 9 digits or 0.1 Hz
Small size, 3½" H, ½ rack W
BCD output for systems use
Remote programming

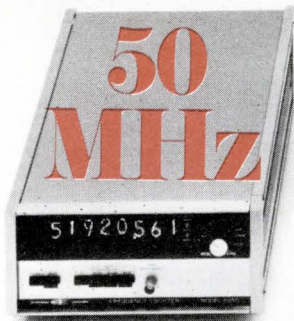

\$770



\$1,050



\$1,395



\$2,295

Now choose from the industry's widest selection of **frequency counters!** For details or a demo, contact your Scientific Devices office or Concord Instrument Division, 10 Systron Dr., Concord, CA 94520. Phone (415) 682-6161. In Europe: Systron-Donner GmbH Munich W-Germany; Systron-Donner Ltd., Leamington Spa UK

SYSTRON  DONNER

The Systron-Donner Instruments Group:

Alpha Scientific Computer Systems Concord Instruments Datapulse Kruse Electronics Microwave Trygon Electronics

THE ELECTRONIC ENGINEER

August 1972 Vol. 31 No. 8

Cover. With the binocular-sized laser rangefinder, the soldier scans the horizon for the future direction of military electronics. That future, according to Bruce Carlson, president of Sprague Electric Co., may be a lot rosier than the past three years have led many industry observers to believe. With the aid of the Carlson curve, a predicting tool based on the relationship between amount of money spent per man in the Armed Forces and the relative electronic sophistication of each nation's military forces, we examine the world's defense electronics market. Also looking at that market (see p. 12), with the aid of the Carlson curve, are presidential nominee George McGovern, former Deputy Defense Secretary David Packard, and Assistant Defense Secretaries Eberhardt Rechtin and Robert C. Moot.

- 6 Editorial
- 8 Up to Date
- 12 Challenge
- 27 Digital Readout Course
- 47 IC Packaging Course
- 51 IC Packaging Exam
- DC-1 Data Communications
- DC-5 Data Communications Feature
- DC-10 Data Communications Products
- DC-14 Data Communications News
- 70 Design Feature
- 73 Systems Products
- 78 Subsystems Products
- 84 Lab Products
- 86 Lit Items
- 95 Advertising Index
- 96 Samples

12 THE GREAT MILITARY ELECTRONICS PLOT: the Carlson curve J. McNichol

Can the future be predicted? It can, if it's the destiny of military electronics, says Sprague president Bruce Carlson. Here's a look at what such diverse experts as Carlson; past and present DoD brass Packard, Moot, and Rechtin; and Sen. McGovern say on where defense electronics is going.

27 DIGITAL READOUT COURSE—PART 2

Like gunslingers on the street of a western town, the different display technologies are trying to knock each other off, and you could be the winner. Aimed at the system designer who must make a readout decision, all the pluses and minuses of the different displays are presented.

- Introduction** Stephen A. Thompson, **The Electronic Engineer**
- Gas discharge: displays with a glow on** Richard Saxon, Burroughs Corp.
- Gas discharge: planar building blocks** Larry Pond, Sperry Rand Corp.
- Incandescents: directly viewed filaments** P. L. Farine, RCA Corp.
- Incandescents can be indirect** Stephen A. Thompson, **The Electronic Engineer**
- Vacuum fluorescent: the segmented CRT** R. T. Raago, Warner Electric Corp.
- LEDs** William Otsuka, Monsanto Corp.
- LED materials** Dick Ahrons, Opcoa Inc.
- The promise of liquid crystal** Edward Kornstein and Nunzio A. Luce, Optel Corp.
- Electroluminescent displays** R. D. Webb, Sigmatron, Inc.
- Where are we today?** Stephen A. Thompson, **The Electric Engineer**

47 PACKAGING WITH INTEGRATED CIRCUITS COURSE—PART 6

After learning, in the last installment, how to make and wire backplanes, it's easy to see how indispensable a computer is to test the thousands of interconnections. And after testing the backplanes, you're tested too (but not by computer) in the final exam for the course.

- Automatic test must be run by computer** Tom Healey, Instrumentation Engineering, Inc.
- Testing backplane wiring** Teradyne, Inc.
- Final course exam**

DATA COMMUNICATIONS following page 54

DC-5 CAN A MINI SOLVE YOUR COMMUNICATIONS PROBLEM? P. Goldstern

As a natural offshoot of the explosive growth of minicomputers, engineers are giving more consideration to mini's for their data communications systems. But what problems do EEs face with a mini system? To avoid the glitches, know your applications *and* your options.

70 BUILD YOUR OWN 4½-DIGIT DVM FOR \$141 Stephen A. Thompson

A hybrid A/D converter, some logic, readouts, and you've got your own DVM.



KEPCO TALKS POWER SUPPLY TECHNOLOGY:

DIGITAL CONTROL FOR ANALOG VOLTAGE

The interface between things analog and things digital is a fascinating subject that preoccupies a significant part of the electronics business. Products abound for converting digital control signals into analog ones and for digitizing the smoothly varying flow of ordinary things. Why then should we at Kepco feel a great need to introduce a new digital programming interface?

Because the things we control—power supplies—have some special requirements not otherwise satisfied by the available hardware.

1. Isolation . . . When you're controlling a 500-volt d-c power supply and want to be able to ground plus, minus or neither, you will appreciate an absolute separation of the digital and the analog circuits.
2. De-glitching . . . This rather amusing expression describes the process of getting rid of the switching transients in the D/A conversion process. Such transients, however, aren't very amusing when they're driving your kilowatt power supply into saturation!
3. Data Storage . . . If you're controlling lots of analog things (hopefully our power supplies among them), it's nice to have a little memory in each digital interface, so your expensive computer—or whatever—can go on and do other things.
4. Power . . . When you're worrying about system things, who wants to spend time fooling with $\pm 15V$ and $5V$ supplies and their stabilizers, grounding, etc.?
5. Mounting . . . A monolithic or discrete modular plug-in DAC requires that you have something to plug them into—a printed circuit card. . . .

Designing and debugging the card is a lot of work.

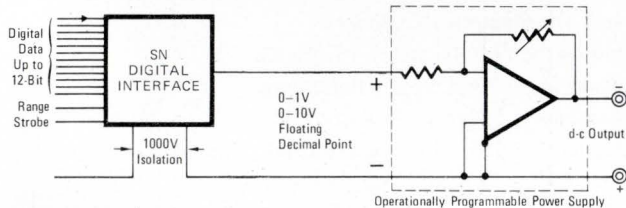

THE "SN" COUPLES TO A PROGRAMMABLE POWER SUPPLY IN PLACE OF ITS NORMALLY FIXED REFERENCE.

To help you solve these problems Kepco has designed the SN Digital Interface for our power supplies (and other analog-controlled devices) incorporating:

1. Optical isolation that can support up to 1000 volts.
2. A 6 microsecond, built-in delay-storage system to completely eliminate "glitches" (total settling time: 26 microseconds).
3. A latching memory, addressed by a separate strobe—so you can control what is placed in storage.
4. A self-powered system with built-in regulated power supplies including their transformer. . . just add 115/230V a-c.
5. All this is on a printed circuit card that can plug-in to a variety of bench, chassis and rack hardware. Additionally, all the I-C's, opto-couplers and the DAC plug into the SN's board, so you can maintain it yourself.

Five SN programming cards are offered—2-digit and 3-digit BCD and 8-, 10- or 12-bit binary.

We've published a nice brochure describing our SN programmers and would be delighted to have the opportunity to send it to you.

with KEPCO you're in control!

write Dept. EL-19

KEPCO, INC. • 131-38 SANFORD AVENUE • FLUSHING, N.Y. 11352 • (212) 461-7000

Circle Reader Service #4

THE ELECTRONIC ENGINEER

August 1972
Vol. 31 No. 8

Bernard M. Gittelman.....Publisher
Alberto Socolovsky.....Editor
Arthur J. Boyle.....Managing Editor
John E. Hickey, Jr.....Features Editor
Sheldon Edelman.....Western Editor S. F.
Stephen A. Thompson.....Western Editor L. A.
John McNichol.....New Directions Editor
Deborah P. Wilkins.....Assistant Editor
Dr. O. M. Salati.....Consultant
Anne Axe.....Editorial Assistant
Mae Moyer.....Editorial Reader Service
Andrew Mittelbrunn.....Chilton Art Director
Phae Featherston.....Artist
George Baker.....Washington News Bureau
Neil Regeimbal.....Washington News Bureau

Executive and Editorial Offices:

One Decker Square, Bala-Cynwyd, Pa. 19004
Tel: (215) SH 8-2000

Address Mail to:

56th & Chestnut Sts., Philadelphia, Pa. 19139

Western Offices:

Stephen A. Thompson
3727 W. 6th St., #202, Los Angeles, Calif. 90005
Tel: (213) DU 7-1271

Sheldon Z. Edelman

199 First St., Rm. 335, Los Altos, Calif. 94022
Tel: (415) 941-6655

Chilton Officers & Directors: Robert E. McKenna, Chairman; William A. Barbour, President; Richard H. Groves, K. Robert Brink, Executive Vice Presidents; John H. Kofron, Charles W. Hevner, Senior Vice Presidents; James Miades, Vice President, Finance; Thomas J. Casper, Spencer H. Collmann, John P. Kushnerick, Raymond O. Nelson, Eugene C. Beaudet, William A. Phair, David Acton, Donald P. Jones, Richard C. Sorlien, Directors; James A. Naughton, Vice President, Creative Services; Christian H. Miller, Secretary.

Monthly publication of Chilton Company, Chestnut & 56th Sts., Phila., Pa. 19139. (Area Code 215) SHERWOOD 8-2000. Controlled circulation postage paid at Philadelphia, Pa. \$1 a copy. Subscription rates U. S. and U. S. Possessions: 1 yr. \$12.00; 2 yrs. \$20.00. Canada 1 year \$14.00; 2 yrs. \$25.00. All other countries 1 yr. \$20.00; 2 yrs. \$35.00. © Chilton Company 1972. Title Reg. U.S. Patent Office. Reproduction or reprinting prohibited except by written authorization. Microfilm reproductions of **The Electronic Engineer** and its predecessors, **Electronic Industries** and **Tele-Tech**, may be obtained from University Microfilms, 313 N. First St., Ann Arbor, Mich.

The Chilton Electronics and Instrumentation Group

The Electronic Engineer
Instruments and Control Systems
Instrument & Apparatus News
Medical Electronics and Equipment News
Electronic Component News

Chilton

You've caused some trouble, boy . . .

We have a two-time winner on our editorial team—Jack McNichol, New Directions Editor. Jack, who came from Philco-Ford three years ago, has won the Tom Campbell Editorial Award, top prize for editors at the Chilton Company; publisher of **The Electronic Engineer**. He is a winner on two counts: as an editor, and as a man who looks for new directions for our reader, the electronic engineer. In this quest, Jack has spent a lot of time in Washington looking at the prospects, and the money available, for conversion of engineers from the declining aerospace and defense industries to new non-military areas such as pollution, transportation, housing, and health. Two of his articles "There is an EE in the White House" (April 1971), and "Will EEs join the war on pollution?" (July 1971), caught the judges' attention and won him the second prize in the 1971 Tom Campbell Editorial competition.



Looking for dollars, both within and outside the military budget, that will beget jobs for our readers, Jack is certainly no stranger to the military circuit. He feels at home in the long corridors of the Pentagon, and has sat through vital discussions in some of its more exclusive offices. That's where, together with Editor Alberto Socolovsky, two years ago, he interviewed David Packard, the electronic engineer who was at that time Number 2 man in the Pentagon.

Looking for systems opportunities both in and out of the military took Jack to an unlikely place, North Adams, Mass., headquarters for the components manufacturer, Sprague Electric Company. There he discussed with Bruce Carlson, President of Sprague, an idea Mr. Carlson had developed to predict the electronic dollars that go into weapons. Then, Jack took both the curve and the results of his discussion back to the Pentagon for comments. After mulling over the data, bouncing it in several offices, and getting a more complex answer the higher he went, a colonel snapped at Jack: "You've caused more trouble with this Carlson curve, boy . . ." Perhaps, but he feels the curve is useful to both our readers and the industry and, therefore, worth causing trouble. Both the Carlson curve and Jack's comments start on page 12. Read them, they're the comments of a winner.

Bernie Gittelman

Bernard Gittelman
Publisher

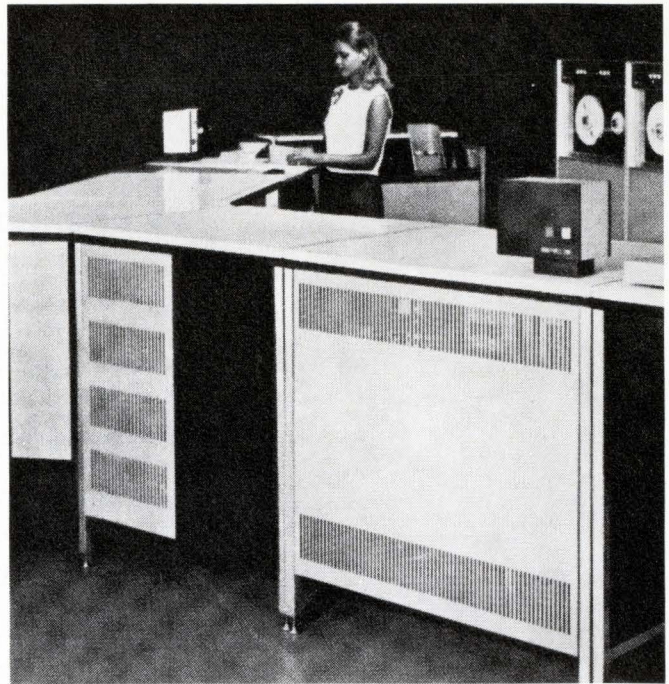

NOW
put backbone
in your housings
and sell
in your machines

First impressions often influence *final* decisions and acceptance. Even sophisticated machinery cries out for housing design that says . . . beauty purpose . . . versatility. And nothing says it better than unique Met-L-Wood® panels. They have the solid feel and characteristics of steel plate without the weight, and the beautiful, durable surface to help the machine sell itself.

Met-L-Wood panels are fast and easy to assemble . . . almost impossible to damage . . . add more sales appeal than any other material you can use. Get complete information. Send for Bulletin 661 today: MET-L-WOOD CORPORATION, 6755 West 65th Street, Chicago, Ill. 60638



MET-L-WOOD Corporation
STRUCTURAL LAMINATES SINCE 1925

Circle Reader Service #5

When the world is the environment, pay attention to standards

The manufacturer in Buenos Aires builds transformers and boasts that they "not only meet the (local) IRAM standards but also comply with NEMA standards." For him, NEMA (National Electrical Manufacturers Association) standards are a mark of quality and, he hopes, an entry ticket into an export market.

The manufacturer in New Delhi, who builds components by the Indian ISI standards, claims that his components also comply with "Mil Specs." He's referring, of course, to U.S. Military Specifications, and he uses them to promote his components as products.

If American standards have such wide acceptance, to the point of being used (and misused) as a sort of paragon, why the concern, which this magazine shares, about the apathy our industry seems to have towards international standards?

I'll tell you why we are concerned. We've said it before. We've published the reason time and again in this page, and we'll write it once more: in the next 10 years, the consumption of electronic products and equipment will increase almost twice as fast outside the United States as within. Therefore, if the U.S. electronics industry wants to maintain its position of leadership in the world; if it wants to participate in this tremendous growth and reap its benefits, it must pay the admission ticket: comply with local standards. And, since most industrialized and developing countries abroad subscribe to the standardization efforts of the International Electrotechnical Commission (IEC), it may turn out that U.S. participation in the IEC would be quite a bargain, compared to the nightmare it would be if the IEC didn't exist and we had to tailor export products to a motley array of local regulations for each country. Yet, the U.S. heed to international standards is still considered by many as some sort of a Communist plot against free enterprise, somehow mixed up with, and just as despicable as, the adoption of the Metric system. It's time to grow up, and enter the competitive arena of product development for an international market without handicaps. It is time to start paying attention to standards. And, it's time to become familiar with the efforts that ANSI (American National Standards Institute) is making to bring an American voice to the standardization forum of the world, and that tomorrow may mean the difference between a participation in, and contemplation of the international market.*

This is the simple lesson that manufacturers of record players learned long ago, when they furnished a 2¢ bushing with their equipment to speed up the capstan when their 60-Hz synchronous motor was plugged into a 50-Hz line. This is the lesson that manufacturers of instruments and power supplies only relatively recently learned, when they decided to spend a few pennies more for a tapped transformer that could operate at both 110 and 220 V. This is the lesson that manufacturers of potentiometers have yet to learn, or are learning the hard way, when their pots with ¼-in. shafts get locked out by a 6-mm panel hole.

If the whole world is going to be the environment, then think of standards as just another design constraint, not harder to predict, and much easier to solve, than any other environmental condition.

Alberto Socolovsky
Editor

*For more information, write to ANSI, 1430 Broadway, New York, N.Y. 10018.







16 NEW MULTIPLES

FROM THE POWER HOUSE Dual and Triple Output OEM Power Supplies

The most economical power/cost ratios in the power supply industry are now available in 16 new *multiple* output power supplies. These new units are specifically designed for computer, peripheral and instrument applications.

The same high quality components, low manufacturing costs, proven engineering design, reliability and economy incorporated in our highly successful single output OEM Series are here now in our new multiple output series and that means *multiple* satisfaction! We do it better for less, that's why Powertec is the leader in the OEM business. **EXCLUSIVE FEATURES:** Reliability • Economy • Proven Engineering Design • Low Manufacturing Costs • High Quality Components.

	MODEL NUMBER	OUTPUT POWER			100 PIECE** PRICE
		OUTPUT #1	OUTPUT #2	OUTPUT #3	
2K — DUAL OUTPUT	2K15D-1.3	+12V, 1.5A or +15V, 1.3A	-12V, 1.5A or -15V, 1.3A	NA	\$37.00
	*2K5D-3.0	5V, 3.0A or 6V, 2.5A	5V, 3.0A or 6V, 2.5A	NA	
Depth — 2.50	*2K5, 15D	5V, 3.0A or 6V, 2.5A	12V, 1.5A or 15V, 1.3A	NA	
Width — 7.87	*2K5, 24D	5V, 3.0A or 6V, 2.5A	18V, 1.0A or 20V, 1.0A or 24V, 1.0A	NA	
Height — 4.00					
2L — DUAL OUTPUT	2L15D-2.8	+12V, 3.0A or +15V, 2.8A	-12V, 3.0A or -15V, 2.8A	NA	\$65.00
	*2L5D-6.0	5V, 6.0A or 6V, 5.0A	5V, 6.0A or 6V, 5.0A	NA	
Depth — 2.75	*2L5, 15D	5V, 6.0A or 6V, 5.0A	12V, 3.0A or 15V, 2.8A	NA	
Width — 9.38	*2L5, 24D	5V, 6.0A or 6V, 5.0A	18V, 2.0A or 20V, 2.3A or 24V, 2.3A	NA	
Height — 4.88					
2R — TRIPLE OUTPUT	2R-70T	+12V, 1.5A or +15V, 1.3A	-12V, 1.5A or -15V, 1.3A	5V, 6.0A or 6V, 5.0A	\$69.00
	*2R-72T	5V, 3.0A or 6V, 2.5A	12V, 1.5A or 15V, 1.3A	5V, 6.0A or 6V, 5.0A	
Depth — 2.87	*2R-74T	5V, 3.0A or 6V, 2.5A	18V, 1.0A or 20V, 1.0A or 24V, 1.0A	5V, 6.0A or 6V, 5.0A	
Width — 11.00	*2R-76T	12V, 1.5A or 15V, 1.3A	18V, 1.0A or 20V, 1.0A or 24V, 1.0A	5V, 6.0A or 6V, 5.0A	
Height — 4.88					
2S — TRIPLE OUTPUT	2S-140T	+12V, 3.0A or +15V, 2.8A	-12V, 3.0A or -15V, 2.8A	5V, 12A or 6V, 8.0A	\$119.00
	*2S-142T	5V, 6.0A or 6V, 5.0A	12V, 3.0A or 15V, 2.8A	5V, 12A or 6V, 8.0A	
Depth — 4.00	*2S-144T	5V, 6.0A or 6V, 5.0A	18V, 2.0A or 20V, 2.3A or 24V, 2.3A	5V, 12A or 6V, 8.0A	
Width — 15.00	*2S-146T	12V, 3.0A or 15V, 2.8A	18V, 2.0A or 20V, 2.3A or 24V, 2.3A	5V, 12A or 6V, 8.0A	
Height — 4.88					

All outputs are floating, can be connected in any common configuration unless otherwise noted. Other voltages and currents available, consult factory for price and delivery.
*NON-STOCKED ** For quantities other than 100, contact factory.

SPECIFICATIONS: INPUT: 115VAC \pm 10V, 47-63 Hz • REGULATION: Line \pm .25%, Load \pm .25% • RIPPLE: 1mv RMS 5 & 15V • RESPONSE: 50 μ sec typical • TEMPERATURE: 0°C to 40°C derated to 71°C • O.L. PROTECTION: Current limit/foldback • Optional OVP available. **DELIVERY:** stocked models within 24 hours, 30 days for others.

Incidentally, if you don't see your exact model on the chart, we'll build an OEM *multiple* from stocked subassemblies in any voltage/current combination. Give us a call and we'll be glad to quote within 24 hours. Stay within the same size and power rating, and the price won't change.

POWERTEC INC. an Airtronics Subsidiary
9168 DeSoto Ave., Chatsworth, California 91311 • (213) 882-0004 • TWX (910) 494-2092

POWERTEC

Electroluminescence lights up . . . Universal Data Machines has awarded Sigmatron a major order for electroluminescent displays. The So. California manufacturer will supply \$3 million worth of readouts, mostly 0.5-in.-high digits, for desk top calculators.

Circle Reader Service #260

Commercial memory system . . . Fairchild's Systems Technology Div. is building a 1.5 million byte semiconductor memory subsystem for Interactive Data Corp.'s IBM System/360/67 computer. Incorporating their 256-bit bipolar LSI memory circuits, the semiconductor memory is Fairchild's first bipolar memory subsystem sold to a commercial user.

Circle Reader Service #261

Fighting fires electronically . . . Under a \$5-million contract, the Communications Systems Div. of North American Philips will provide the City of New York with a two-way voice communications system to aid in fighting fires. Initially, 3100 units will be installed.

Skylab puts new life in outer space . . . As the Apollo space program phases out, Skylab, the modular space station with reusable shuttle, will dominate the U.S. space program in the 70's, reports Frost & Sullivan, a market research consulting firm. The Skylab program is estimated at a cost of just \$5.5 billion. Frost & Sullivan's report, "The Space Market in the 70's," also contains an analysis and runout costs of existing and proposed programs such as Earth Resources Technology Satellites, (ERTS), Applications Technology Satellite (ATS), Helios, and the funding for the ten major groupings of the \$1.7 billion DoD space program. For information contact Frost & Sullivan Inc., 106 Fulton St., New York, N.Y. 10038.

Reemployment of aerospace engineers . . . The latest employment survey by the Aerospace Industries Association forecasts a continuing decline through Dec. 1972. The estimate for total aerospace employment is 887,000 by the end of 1972, which represents a decline of 37,000 from Dec. 1971. To offset this picture, the National Society for Professional Engineers (NSPE) has announced a Technology Utilization Project, intended to place aerospace/defense engineers in commercial or industrial positions. Funded by the U.S. Dept. of Labor, the seven-month program is a follow-on to NSPE's recently-completed Skills Conversion Research Project. Reemployment will be concentrated in twelve areas including food technology, environmental systems, construction, medicine, power/utility, transportation, criminal justice and systems analysis, and more. Companies and persons interested in participating in the program may get details from the National Society for Professional Engineers, 2029 K St. NW, Washington, D.C. 20006.

Figuring the future of electronics . . . More than one-third of 1985's world consumption of electronics equipment will be in the U.S., according to EIA analysts. The U.S. is expected to account for \$81 billion of the \$205 billion worldwide market. Growth of world electronics will average 10% a year between 1970 and 1975, and decline to 8.3% from 1980 to 1985. At \$121 billion, industrial products will make up the largest part of the 1985 market, with government and consumer markets trailing far behind at \$48 and \$36 billion. Copies of the forecast are available for \$50 from the EIA, 2001 Eye St. NW, Washington, D.C.

Politics, engineering style . . . Addressing the 1972 Democratic Platform Committee, the National Society for Professional Engineers (NSPE) and the Institute of Electrical and Electronics Engineers (IEEE) urged that solutions to engineering-oriented problems are the most critical challenges facing our nation this election year. Specifically cited were a full-scale attack on pollution, providing assistance for mass transit, an expanded program of research to build low- and medium-cost housing, continued space exploration with results in improved commercial and consumer products, and the most effective development of technology in the public interest.

Electronics in military contracts . . . In May, the Department of Defense issued contracts for electronic equipment and systems as follows: Air Force, \$44 million; Army, \$53 million; and Navy, \$64 million. Major areas were aircraft equipment and systems (\$38 million), missile systems (\$26 million), sonar and radar systems (\$24 million), and computers and computer-related equipment (\$18 million). The Navy awarded a contract for over \$12 million to Litton Systems Inc., for work on the Carrier Airborne Inertial Navigation Systems.

Bits of information . . . Fiat has placed an \$11.5 million order with **Honeywell** for three large-scale Series 6000 computer systems . . . **Although profits will lag** far behind, the computer services industry is expected to reach revenues of \$7.5 billion by 1976, according to the research and consulting firm, Creative Strategies Inc. . . . **Panasonic's** advanced Total Electronic Electro Tuning model for TV tuning features 10-key decimal selection with digital channel display, using binary-coded signals for switching preset voltages on varactor diodes.

The 14th Annual Conference of the Electronic Materials Committee of the Metallurgical Society of AIME will cover materials research for applications in displays, computers, and communications. The Conference takes place Aug. 28-30 in Boston . . . **Dr. R. S. Carlson**, pres. of **North American Rockwell Microelectronics Co.**, has noted that sales of electronics to the government, which were more than 60% of the industry's total sales in 1962, are now only a third of total industry sales.



APPROVED MIL-C-39010

Nytronics' history of technical leadership in inductors has a new chapter. The first company to extend the standard line concept to variable inductors has remained ahead in every subsequent step of refinement and miniaturization.

Today, there's a new place for a familiar group of inductors under highest reliability military specifications—MIL-C-39010

With sizes ranging from the world's smallest shielded inductor to the most complex variable inductor...shielded, unshielded, chip and variable, in hundreds of off-the-shelf values...it makes good sense to check first with Nytronics or your local distributor.

Now tested and approved to highest reliability military specifications.

Nytronics Standard Inductor Part Number	Standard Military Series	New High Reliability Qualification
SWD	MS90537	MIL-C-39010/01-0001 thru /03-0185
SWD	MS75037	MIL-C-39010/01-0001 thru /01-0046
SWD	MS75088	MIL-C-39010/02-0001 thru /02-0053
SWD	MS75089	MIL-C-39010/03-0001 thru /03-0185
RFC-SS	MS18130	MIL-C-39010/06-0001 thru /06-0061 /07-0001 thru /07-0037
RFC-S	MS75008	MIL-C-39010/04-0001 thru /04-0049 /05-0001 thru /05-0045



Nytronics, Inc.

ORANGE STREET, DARLINGTON, S. C. 29532
(803) 393-5421 • TWX 810-665-2182

Circle Reader Service #7

Machining circuits with lasers

With this new laser machining process you can design electronic circuit patterns directly into a ceramic substrate in one easy step. In the new process, a laser etches a circuit pattern into the substrate with the help of coded signals from a computer programmed to define the characteristics of the circuit pattern.

Coated with a thin film of conductive metal, the substrates are mounted to a circular drum. As the drum rotates, the substrates are exposed to a laser beam. One line at a time, the laser scans the entire length of each substrate. At the end of one complete rotation of the drum, a reflecting mirror directs the laser to the next line.

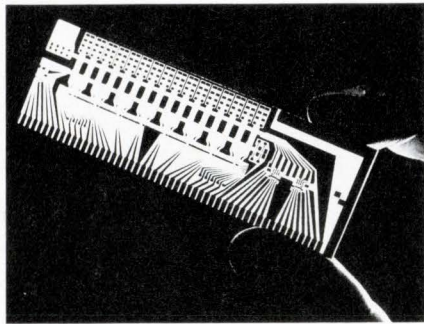

To inscribe the circuit pattern into the substrate, the focused laser beam vaporizes regions of the metal coating of each substrate. Whether an area is to be vaporized or left intact is determined by the coded signals in the computer.

Laser machining requires fewer processing steps than masking-and-etching processes, and does not need a clean room. Its depth of focus easily overcomes surface irregularities; the non-contact process avoids damaging the metal film; and since there are no photographic masks to wear out, the process may be repeated.

More information on the experimental process is available from Bell Laboratories, 600 Mountain Ave., Murray Hill, N.J. 07974.

Circle Reader Service #262

Flat CRT debuts

Combining forces, GTE Sylvania and Northrop have come up with a flat alphanumeric, 512-character (FTA-512) CRT display. The display is now being

demonstrated at private showings throughout the country to promote the development of products for commercial applications, and determine how it competes with other candidates for long-life displays.

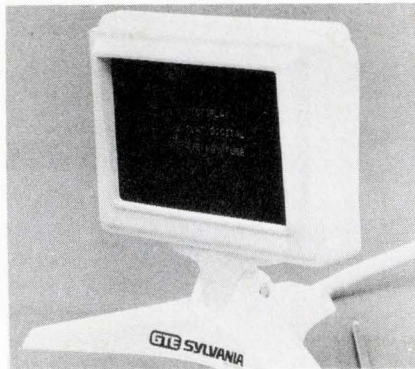

The digitally addressed, flat CRT is 2 in. thick and has 512 characters arranged in 16 rows of 32 characters each. Each character measures 0.18 x 0.25-in. (4.6 x 6.3 mm) and consists of a 5 x 7 dot matrix. Cathodic electrons accelerate through four switching plates that determine which dots will light up the face of the tube, providing a distortionless, slew-rate-free display.

GTE Sylvania's Electronic Components Group is accepting requests for samples and pricing them on an individual basis with a 90 to 120-day delivery. For complete details and samples information, write to GTE Sylvania Inc., Electronic Components Group, Electronic Tube Div., Seneca Falls, N.Y.

Circle Reader Service #263

TV games you emcee

A new idea in home entertainment turns any home TV set into an electronic playground for table tennis, football, battleship, and many other games. Called Odyssey, the electronic game consists of a computerized master control unit, two individual player controls, a printed circuit card and mylar overlay for each game, and an antenna/game switch.

To play a game, you tape the appropriate game board or playing field overlay onto the TV screen and insert the game's program card into the master control unit.

The game program card makes the interconnections that establish the "behavior" of the master control unit. The



self-moving or player manipulated images are light pulses produced by the master unit on the TV screen. These are dictated by signals passing from the control unit through a cable connected to the set's vhf antenna terminals. Participants control their "players" through individual control units.

Appearing on the market this month, Odyssey will be available at authorized Magnavox dealers for less than \$100. Magnavox Co., 345 Park Ave., New York, N.Y. 10022.

Circle Reader Service #264

Communications deficit

Falling farther and farther behind, the balance of U.S. trade in communications and electronic products continued unfavorably in 1971. At \$570 million, the deficit is more than three times that of 1970's \$181 million, according to the U.S. Dept. of Commerce.

For the first time, the U.S. experienced an unfavorable balance of trade in telephone and telegraph apparatus. The more than \$18 million deficit in this category is attributed to a rapid rise in imports from Japan (now \$30 million and up \$19 million from 1970) and an overall decline in exports of \$14 million (in 1970, this area had a favorable balance of nearly \$21 million).

The major problem, however, remains in the consumer products area, which ran an unfavorable balance of more than \$1.3 billion last year. With most of the imports coming from Japan, radios, TV sets, and tape recorders accounted for 65% of this deficit.

More details of the communications and electronic products trade deficit analysis are available from the U.S. Dept. of Commerce, Bureau of Domestic Commerce, Washington, D.C.

Circle Reader Service #265



Now, Helipot offers covered cermet trimmers for low-budget projects.

There's not much sense in using cheap wirewound or carbon trimmers anymore. Not when the new Helipot Series 91 Cermet Trimmers are available *off-the-shelf* for a few cents more.

These single-turn, $\frac{3}{8}$ " , covered trimmers come in 10 different mounting styles and 19 standard resistance values from 10 ohms to 2 megohms. Covered construction helps protect against moisture, corrosive atmospheres, dust, oil and other

contamination. Which means, in addition to cermet stability and better resolution, you get long-term dependable performance.

The breakthrough price is just 35¢ each in the 50,000 piece quantity, and they're equally well-priced in other quantities.

Send now for complete data on the Series 91 Trimmers... the finest of their class. We've made them for your projects where the budget may be tight, but you don't want to compromise performance.

Beckman®
INSTRUMENTS, INC.
HELIPOT DIVISION
Fullerton, California

HELPING SCIENCE AND INDUSTRY IMPROVE THE QUALITY OF LIFE

INTERNATIONAL SUBSIDIARIES: AMSTERDAM, CAPE TOWN, GENEVA, GLENROTHES, SCOTLAND, MEXICO CITY, MUNICH, PARIS, STOCKHOLM, TOKYO, VIENNA

Circle Reader Service #8

The great military electronics plot: The Carlson curve



Can the future of military electronics be charted? Bruce Carlson, president of Sprague Electric Co., thinks so.

Here's a dollars and cents analysis of defense's destiny with comments by former Deputy Defense Secretary David Packard, presidential nominee George McGovern, and Assistant Defense Secretaries Rechtin and Moot on that look into the future—the Carlson curve.

John McNichol, New Directions Editor

Will the August 1985 issue of **The Electronic Engineer** chronicle the slow demise and death rattle of that bulwark of the U.S. electronics industry—military electronics? Will contract cancellations continue to plague the job security of thousands of electronic engineers, as they did in 1970? The answer to the first question is an emphatic “no,” according to Bruce R. Carlson, president of the Sprague Electric Co. For the second question, he offers a prediction tool—the Carlson curve.

Carlson, the dynamic, gray-haired financial man who's been president of Sprague for the past three years, should know. In fact, he may be the world's greatest authority on the future of the military market—an ironic title for anyone associated with Sprague, which has traditionally been known as a components manufacturer, not at all dependent on defense procurement.

Genesis of a curve

As session organizer and subcommittee chairman of the Agenda Committee of the Electronic Industries Association's (EIA) top-level “Electronics 1985” meeting, Carlson shouldered the responsibility for getting a handle on the elusive world market for military electronics.*

*For more on “Electronics 1985,” which brought together some 300 top executives, see **The Electronic Engineer**, April 1972, pp. 20-21.



**THE
1024-BIT
TTL RAM
IS HERE**



Our new 93415 RAM: 1024x1 bit. TTL. 60ns access time at 0.5 mW/bit. And Isoplanar did it.

The 93415 RAM is the most complex monolithic bipolar read/write memory ever made.

This self-contained subsystem also features 30ns chip select access time, open collector (expandable) output, static TTL operation and decreasing power dissipation with rising temperature. Available now in prototype

quantities in 16-pin hermetic DIP.

What this means to designers of high-speed digital systems is that for the first time they have available a major TTL memory building block that can operate at speeds compatible with those of their systems' logic. Because it's static, the 93415 is simple to use, requires no complicated

peripheral electronics. And because of its functional density and capability, the 93415 gives the designer a fine opportunity to realize significant cost savings by 1) reducing package count, 2) reducing circuit board number and size, 3) reducing number of connections, 4) increasing system reliability.

Functional diagram of the 93415 TTL RAM

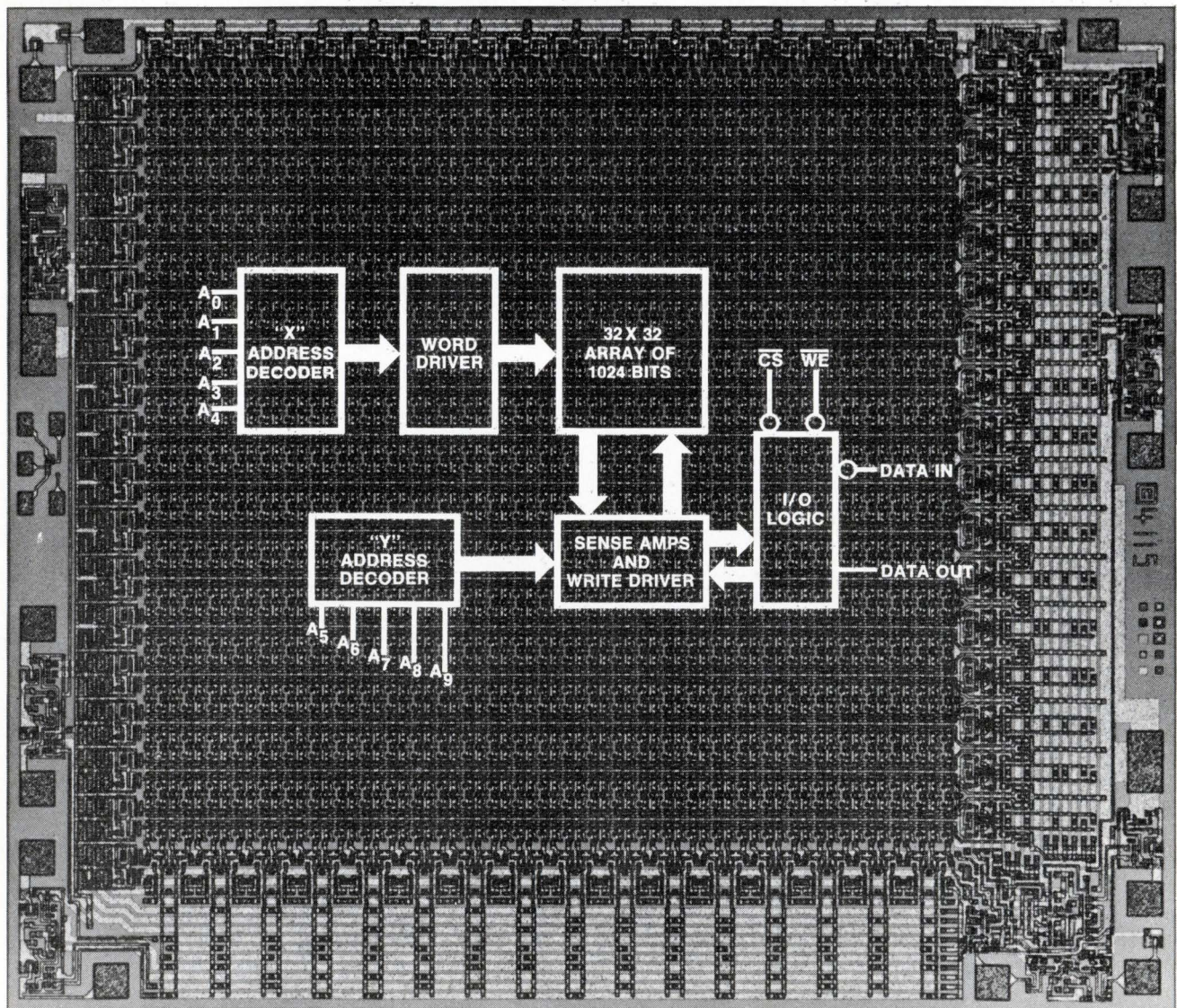

Significant Memory Applications

Some of the more exciting applications of 93415 are: as a fast writable control store for micro-programming, eliminating many present needs for fixed ROMs; as a large high-speed scratchpad to make multiprocessing more feasible; for simulation of long high-speed shift registers; for improvement of buffer or cache memory performance by increasing capacity without any power or size trade-off; and obviously for building cost-effective high-speed main-frame memories.

Isoplanar did it. Again

Our 93415 is the most recent, and most important, product of our isoplanar technology. Isoplanar proved itself last year with the successful introduction, and volume production, of our 93410 256-bit TTL RAM and our 95410, world's first 256-bit ECL RAM.

The introduction of the 93415, another industry first, is just one more demonstration of what isoplanar can do. Soon, isoplanar will do it again, with even more complex TTL and ECL memories.

What is Isoplanar? It's a bipolar fabrication process that replaces conventional planar P+ isolation diffusion with an insulating oxide. Result: High density. High yield. Low cost. Improved speed/power performance (from lower parasitic capacitance). Improved reliability (from planar surface). Isoplanar is the designer's assurance of proven reproducibility and deliverability.

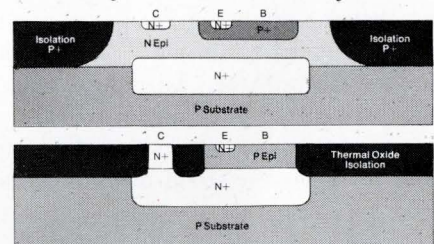

No space is required between base and collector regions and isolation in isoplanar bi-polar (bottom) compared to conventional planar bi-polar (top).

Fairchild Bipolar Memories

BIPOLAR READ/WRITE MEMORY APPLICATIONS SUMMARY					
ORGANIZATION	REGISTERS SYSTEM SPEED 5-30ns	SCRATCHPAD SYSTEM SPEED 15-60ns	CONTROL SYSTEM SPEED 20-70ns	BUFFER SYSTEM SPEED 50-80ns	MAIN SYSTEM SPEED > 75ns
8 x 1	(TTL) 9338, 93S39* (ECL) 9539*				
16 x 1		(TTL) 93407, 93433 (ECL) 95401			
16 x 4			(TTL) 93403 (ECL) 95400		
256 x 1				(TTL) 93410‡ (ECL) 95410‡	
1024 x 1				(TTL) 93415‡ (ECL) 95415‡*	

*IN DEVELOPMENT ‡ISOPANAR DEVICES.

Availability

Some 93415 RAMS are already out in the field in evaluation quantities. Prototype quantities are available now from your friendly Fairchild distributor at the following prices:

1-24 25-99 100-999
\$87.50 \$80.50 \$70.00

Volume shipments available during 4th quarter.

**MADE IN
FAIRCHILD**



Perhaps by hunch, he developed the premise that there should be a relationship between the amount of money spent per soldier and the electronics content of military expenditures. Intuitively, it makes sense; a nation with a low defense budget has little money available for sophisticated weapon systems of high electronics content.

But how to prove it? Carlson had to back this theory of electronic sophistication with hard facts. Yet, in the seemingly hard-fact-filled world of military electronics, facts do not abound. The Department of Defense calls only the strictly electronic systems, such as military communications, electronic but does not break out the electronics content of major systems. The EIA, through its Government Requirements Committee, estimates that content in its analyses of the government market, drawing on the experience of companies that do business with DoD, and forecasts the trend of electronics content in fu-

ture defense budgets.

The EIA figures show that 13% of the 1960 defense budget,* 18% of 1965's, and 14% of 1970's, went for electronics. But no similar figures were available for other countries; even when government expenditures could be obtained, they did not break out the military portion of that budget.

Between October 1971 and May of this year, when the "Electronics 1985" meeting was held in Chicago, Carlson and his experts dug through what limited in-

(continued on page 18)

*While the U.S. figures allowed Carlson to estimate the electronics content of the procurement budget, and to separate from the total budget non-procurement items such as aid to dependents, hospital care, salaries, etc., there is no comparable information available for foreign budgets. The effect of such items cannot be overestimated. The greatest authority on such costs, Comptroller Robert C. Moot, Assistant Secretary of Defense, told **The Electronic Engineer**, "Despite sharp reductions in personnel, pay and related costs continue to rise. In FY 1969 military basic pay and related items (such as separation pay, re-enlistment bonus, and FICA) amounted to \$14.2 billion, and went up to \$17.2 billion in FY 1972 despite a cut in military personnel of 931,000. This apparent contradiction is explained by pay raises. From FY 1969 to FY 1972 military pay rates are up 46.2%, more than offsetting the sharp personnel reductions."

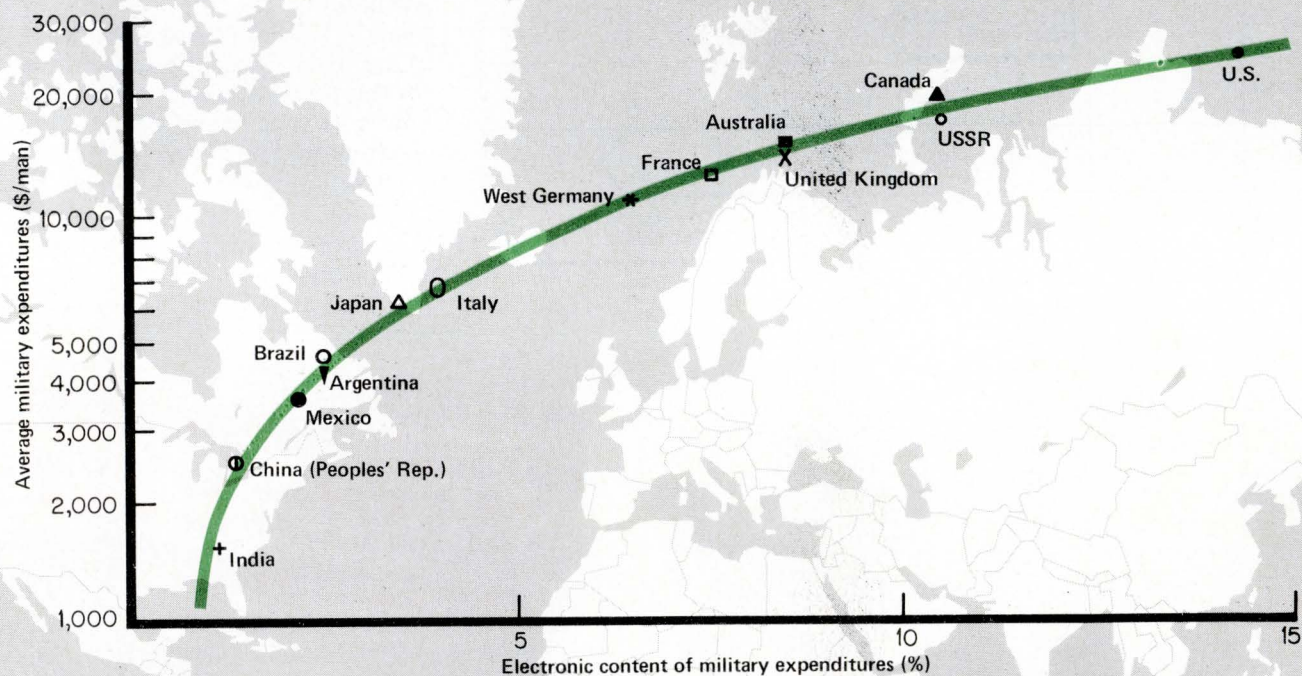

The Carlson curve: Carlson's curve is a tool for predicting the electronics content of military budgets. Bruce R. Carlson, president of Sprague Electric Co., recognized that there is a relationship between the size of the budget (or rather the \$ spent per man), and its electronic contents. What is more important, the relationship seems to apply to all countries in like fashion, unaffected by geographical location or value of currency.

Briefly, the curve shows that military expenditures per man (member of the Armed Forces) increase exponentially with the electronics content of those expenditures. In other words, for every percentage point electronic content in-

creases, the military investment per man has to increase even more.

Intuitively, Carlson's relationship makes sense because the more sophisticated weapons, which have the highest electronic content, are also the ones which demand more defense dollars per man. Indeed, his curve applies to the expenditures by any nation as they vary from year to year. As the graph shows, they depart little from a straight line, when plotted on semi-log paper. But his surprising conclusion is that the relationship also correlates from nation to nation. This may mean that all nations follow a similar path on military technology, in relation to its electronics content.

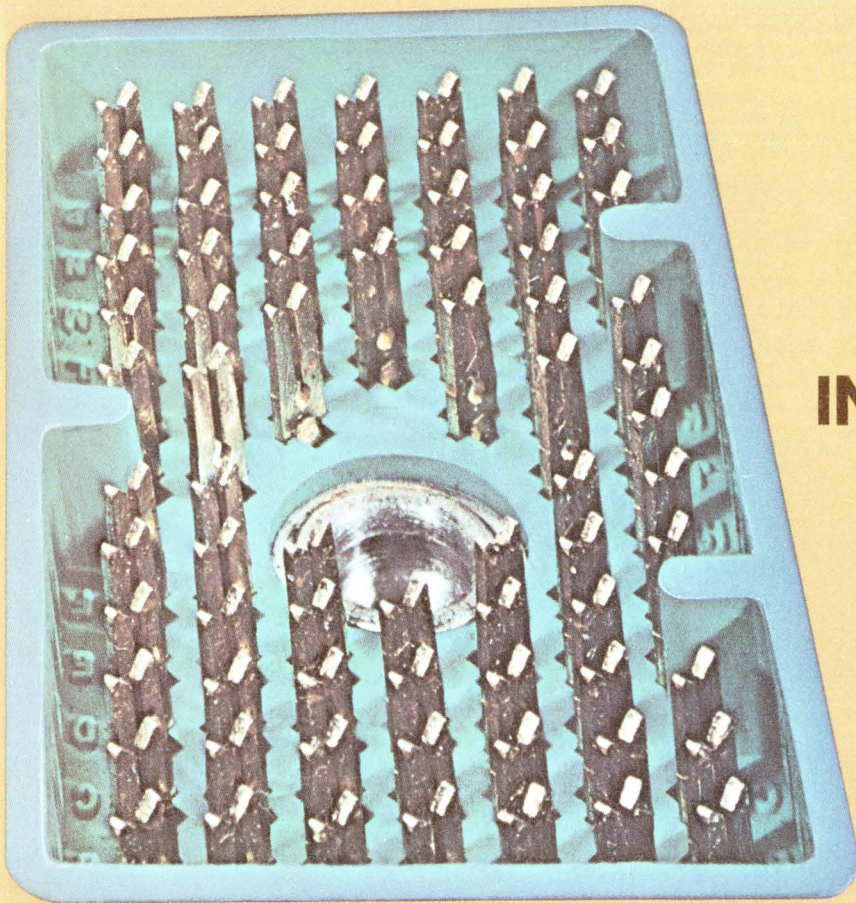

PACKS TWICE THE CONTACTS IN THE SAME SPACE AT ABOUT HALF THE COST

Elco's solution to the escalating packaging squeeze and packaging costs in electronic circuitry. A line-up of I/O rack and panel and cable-to-cable connectors with contact spacing on .100" and .125" centers.

On a performance/price basis, these high density connectors are your best buy. Quality is equal to or better than, and published prices are much less than those of their pin-and-socket counterparts.

Take the Series 8026 R/P and cable-to-cable connector that's equipped with the Elco high-reliability crimp-and-insert mini Varilok™ contact. Team a Series 8026 117-contact plug with its corresponding receptacle, and you have a 117-contact connector that's in the same envelope as a 56-contact connector on .150" spacing. But packing more than twice the contacts in the same space.

The 75-contact 8026 connector will fit in the same space as a 38-contact connector on .150" spacing. And the 8026 33-contact connector is one of the smallest 33-contact R/P connectors you've ever seen. For back-up, we offer Series 8026 connector with 55 and 79 contacts on .125" square grid.

For full details on these new connectors from Elco, contact your local Elco representative or distributor, or: Elco, Willow Grove Division, Willow Grove, Pa. 19090, (215) 659-7000 • Elco, Pacific Division, 2200 Park Place, El Segundo, Calif. 90245, (213) 675-3311.

For your I/O back-panel applications, Elco Series 5540 connectors are available in the same sizes as the 8026, but use the field-proven Varicon™ contact with .025" square wire-wrappable posts. They incorporate—as do the 8026's—a new female turnable jackscrew that eliminates any possibility of damage to plate contacts in difficult or blind mating situations. Both series use standardized polarizing and keying hardware to prevent unmatched plugs and receptacles from being mated.

And by no small coincidence, hardware standardization and using one contact for both sides lets you minimize your in-house and field stocking requirements, and allows you to use the same manufacturing set-up to assemble all sizes.

Besides helping you cope with your close-order circuits, these connectors will help you effect other cost economies. Like using your existing 8016 panel punches. Reducing inventory because they can do duty in R/P and cable-to-cable applications as well as be used as an I/O.

There's one more bonus. Immediate availability. Both series. All sizes. Another service in keeping with CONNECTRONICS, Elco's Total Connector Capability.

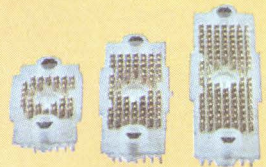

Series 5540 input-output plate receptacles with or without polarizing hardware. On .100" grid with 33, 75 and 117 contacts. On .125" grid with 55 and 79 contacts.



Polarizing hardware provides 36 polarization combinations per connector pair.

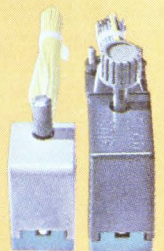

Metal covers for 33, 55, 75, 79 and 117-contact connectors have top and side cable entries.

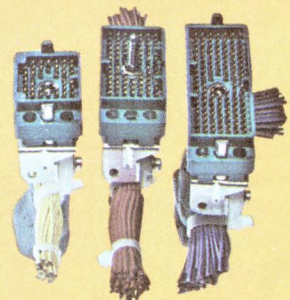

Cable strain relief clamps are adjustable for small and large cable bundles, can be mounted on plug and/or receptacle.



Circle Reader Service #10

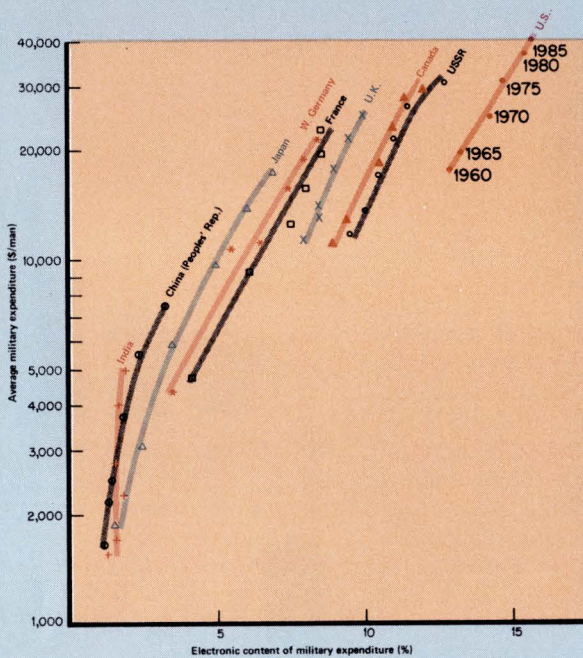

Defense dollars per man (member of the Armed Forces) increase exponentially with an increase in the electronics content of those dollars. This relationship, according to Carlson, applies to all nations independently of the value of their currency. Western nations seem to follow the exponential function more accurately than Russia, Japan, and China, which are undergoing more rapid changes in electronics content.

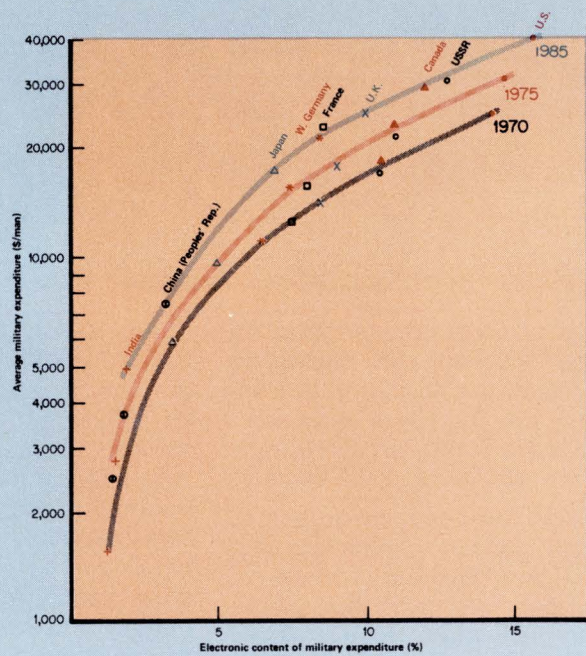

Snapshot of military electronics. For any one year, the points which relate electronics content vs expenditures per man, for all nations, seem to fall along a curve—the Carlson curve. This suggests that most nations apply approximately the same electronics technology to control essentially the same functions in their weapons.

formation they could uncover on the electronics budget of such countries as Brazil, Israel, the U.S.S.R., and Japan. Studies by such firms as Stanford Research Institute and Arthur D. Little were also consulted.

As they plotted the points for selected countries the relationship between expenditures per man and electronics content for defense budgets appear to fall more or less on a similar curve from India, which

spent \$1600 per man in 1970, to the U.S., which spent \$25,000. The Carlson curve was born.

But the curve is exponential

Highly developed nations, the U.S., Canada, the U.S.S.R., Australia, the United Kingdom, France, and West Germany, are all clustered at the top in the big money league. In the middle are the developed

(continued on page 20)

VIDAR INTRODUCES VIMAC. . .

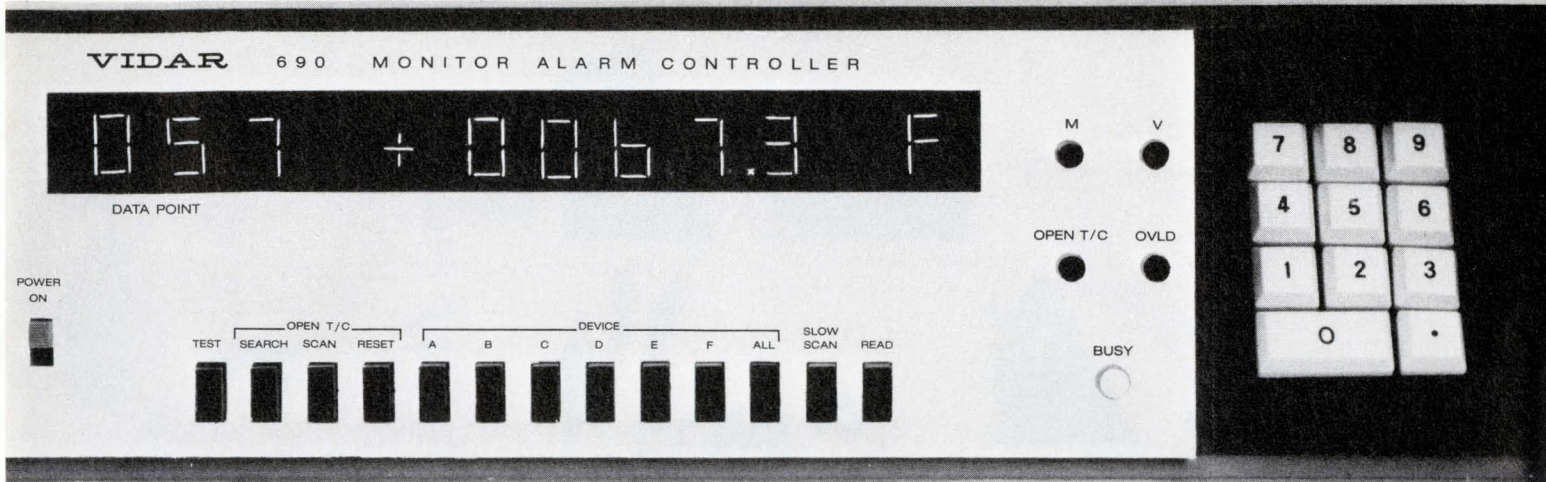

A New Concept-- Digital Interactive Monitoring

VIMAC, the new VIDAR 690 Monitor Alarm Controller terminal now makes it economically feasible for up to *seven* users to share *one* data acquisition system. Not only can one to 1000 channels be continuously monitored at up to seven operator-controlled VIDAR 690s, but each VIMAC terminal can: initiate system scans; call up data from any desired channel; continuously update for trend data. Used in conjunction with a VIDAR Digital Data Acquisition System (D-DAS), VIMAC will provide read-out in engineering units for temperature (C & F), millivolts, volts and optionally, ohms, vac, psi, ft/lb, and many other parameters. In addition, VIMAC displays pre-data, digital clock, or any five BCD devices.



The VIDAR Monitor Alarm Controller has special application in temperature measurement. If a thermocouple should open, VIMAC will alarm; this feature is relevant to other types of transducers. Operating in an "Open T/C Search" mode, the VIDAR 690 can command the D-DAS to stop scanning when an open T/C channel is reached; the data point is then displayed.

VIMAC application is universal and is a significant addition to an already comprehensive VIDAR systems capability. Find out how this new concept—digital interactive monitoring—can provide you with an *honorable solution* to your data acquisition problems. Circle the reader service number for a free brochure on VIMAC or write for details to Dick Kennedy, product manager, VIDAR, 77 Ortega Ave., Mountain View, Calif., 94040. **Circle Reader Service #11**

Offices in:

Atlanta (404)458-0993 • Boston (617)922-7192 • Chicago (312)539-4838 • Cleveland (216)267-0445 • Denver (303)986-1000
Los Angeles (805)498-6017 • New York (201)647-5888 • San Francisco (415)327-9270 • Washington, D.C. (703)534-6241

Contact head office for export

The Carlson curve:

It all depends on your point of view . . .*



Robert C. Moot, Assistant Secretary of Defense (Comptroller): "Despite sharp reductions in personnel, pay and related costs continue to rise. From FY 1969 to FY 1972 military pay rates are up 46.2%, more than offsetting the sharp personnel reductions of 931,000 (military) and 188,000 (civilian)."



Eberhardt Rechtin, Assistant Secretary of Defense (Telecommunications): "... more sophistication does not buy more defense."

George McGovern, U.S. Senator and the Democratic candidate for President: "There will be under my proposals severe cutbacks and even cancellations in programs with a high electronics content."



David Packard, Chairman of the Board of Hewlett-Packard Co. and former Deputy Secretary of Defense: "The current use of our 'smart bombs' in Viet Nam is a good example of a much smaller force being much more effective because of greatly increased use of electronics."

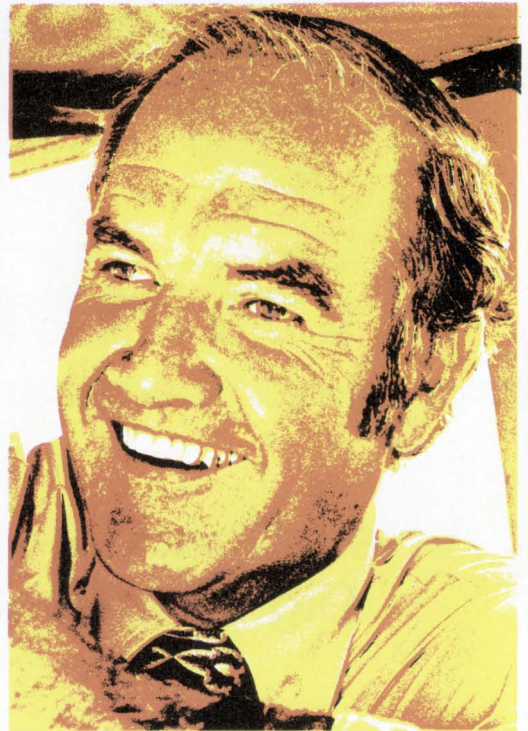

*As told to the editors of **The Electronic Engineer**.

nations, such as Italy and Japan (kept from top ranking by the peace terms of World War II). At the foot go the Middle Eastern and Latin American countries, Mainland China, and India.

Military electronics is like rock music

There's a two-fold meaning to the Carlson curve. One, the very fact that there is some pattern to how various nations spend their budget for defense electronics means that future spending can be predicted, short of complete peace or global war. Two, like music, which needs twice the power to increase the sound by 3 dB, military spending varies exponentially. Like the rock groups, the higher up in the curve a nation is, the more it must spend to increase the electronics content of its military budget.

How to smooth the transition from military to civilian systems

Carlson sees a steady growth in the expenditures-

per-man ratio for the U.S. rising from about \$25,000 in 1970 to \$40,000 in 1985. The accompanying increase in electronics content during the same period will go from 14.25% to almost 16%. Overseas, the same trend continues with some kind of inevitability.

What does this mean for the U.S. electronics industry caught between the slashed defense budgets of FY 1971 and 1972 and the less than dynamic civilian markets? Carlson's answer is to use the continuing and expanding need for defense electronics to carry your firm, while adjusting to the realities of the new civilian markets.

"There are opportunities for our electronic manufacturers to develop and produce equipment," states Carlson emphatically through the smoke of his ever-present cigar. "For instance, the NATO countries need the kind of sophisticated avionics and guidance systems we can supply.

"Unfortunately, the aerospace companies have



thought of themselves for decades as one-customer suppliers, and that one customer was the Department of Defense. Until recent years they just haven't thought of other outlets for their skills. But our study shows that opportunities do exist on a worldwide basis, and will continue to exist as the developing nations become more militarily sophisticated."

But will the rest of the world continue to buy the sophisticated gear the U.S. electronics industry has been noted for?

Without hesitation, Carlson responds, "Sure, and for one reason only: America, as the curve shows *par excellence*, has the technological edge in the military electronics area. So unless you assume the U.S.S.R. will export their military technology, which is doubtful for political reasons, the U.S. has a head and shoulders edge over anyone else, if we just capitalize on it."

Is Carlson slighting the conversion to civilian sectors of the market? Far from it. But the Sprague president spells out some hard facts. "Look, I'm not saying these companies shouldn't be trying the non-military markets. It's just that they should also broaden their existing marketplace by taking a worldwide view.

"It's fine to talk about technology transfer and the application of systems design techniques to urban problems, but these industries must keep together the skills and people they've gathered over the past 30 years. And these same companies can't do that now strictly with technological fallout; it's just not here yet.

"Another problem is marketing the technology transfer products: the market is as diffuse as the defense market is concentrated." Pausing, Carlson brings up an example from his locale. "These companies want to make the marketing shift to deal with the Board of Selectmen of Williamstown, Mass., to sell law enforcement electronic equipment or speed radar. However, it's a very different ballgame from selling the Defense Department when you have 40 men in Washington who have the right contacts. It'll take time to make the transition."

What if McGovern becomes President?

Despite Carlson's bullish stand on the future of U.S. defense electronics, there is one major fly in the ointment—the McGovern alternative defense budget. The Democratic Party candidate for President has made no secret of his plans to bring it down from its

present \$80 billion level to \$54.8 billion within the next two years.

Turning to a mini-calculator perched on his desk, Carlson keyed in the bad news for electronics companies. "Suppose McGovern's cuts brought expenditures per man down from \$25,000 to \$11,000. This would mean, if the rest of the priorities remained the same, that the electronics content would drop to 5%. Of course, if McGovern were to rearrange priorities, the electronics content might rise."

But what effect does George McGovern himself predict his budget will have on the electronics industry and the employment of electronic engineers? Acknowledging the U.S. preeminence as having "the greatest electronics industry component in its military expenditure," the Democratic candidate told **The Electronic Engineer**, "If the McGovern military budget were considered in isolation, there would be great cause for concern by the electronics industry. Although the greatest single cutback by far will be in funding active duty forces, there will be severe cutbacks and even cancellations in programs with high electronics content. However, if my program is considered as a whole, it does, I believe, offer some hope for the electronics industry."

That less than sanguine expression, "some hope," arises from McGovern's analysis of comparative R&D investments of the U.S. and the combined nations of Western Europe and Japan to respond to **The Electronic Engineer's** questions on the Carlson curve. In the analysis, the U.S. comes off a poor second: 1.1% of its GNP goes to non-military R&D, while 2.2% of the GNP of Western Europe and Japan goes for civilian-oriented R&D. Another McGovern finding: with a GNP only 20% larger than ours, Western Europe, Canada, and Japan together are able to employ twice as many technically trained people on "economically relevant R&D."

After giving his program, which involves such projects as a boost for civilian-oriented research and development, and attack on urban problems such as transit and clean air, patent reform, aiding defense contractors in converting to non-military areas, and a better run defense procurement policy to get away from the boom-or-bust cycle, McGovern told a few sad truths. "This . . . could never be a complete solution for scientists and engineers because few civilian industries are as R&D-intensive as the military. Even after successful conversion, there would not be enough jobs for all of the scientists and engineers."



Whether or not this conflicts with McGovern's statement on employment possibilities of "economically relevant R&D," remains to be seen.

Defense on Carlson

Outside of the electronics industry, the one group most interested in the implications of the Carlson curve is the Department of Defense. Newly appointed Dr. Eberhardt Rechtin, Assistant Secretary of Defense for Telecommunications, noted the trend of more advanced countries to obtain more sophisticated weapons. "It's a natural consequence of countries able to afford the expense and able to minimize the manpower devoted to defense purposes—a trend that dates back as far as the Egyptians."

But, according to Rechtin, there are limits. Pointing to such examples as the B-1, Trident, F-111, DD 963, and others, he developed his own theorem: a per unit price per weapon is reached when the unit price times the minimum number required is the maximum that can be afforded.

"Beyond some per unit cost, no matter how good the weapon, insufficient numbers are purchased to significantly affect the course of the battle," says Rechtin. "In brief, more sophistication does not buy more defense."

When he applies his theorem to the Defense Department, Rechtin sees weapon unit price pressure forcing electronics per unit costs down as the number of electronics units per weapon goes up. He notes the industry's response to this problem of cost limiting: LSI, automated production (to cut labor costs and rejects), and lesser power consumption, as in the AX and MSTOL* programs.

Although the telecommunications chief stresses his belief in the ability of the electronics industry to respond to any present-day demand from the military, he is unsure about the future. "The unanswerable question," suggests Rechtin, "is whether there would be an adequate response in the late 1970s—the period of great concern to today's strategists."

Packard on Carlson

While Rechtin may have doubts about the industry's reaction to military needs in the future, former Deputy Secretary of Defense, David Packard,

does not. "Our industry can meet any probable requirement because despite recent cutbacks there is a very strong base on which to expand."

Packard, now Chairman of the Board of Hewlett-Packard Co., talks of the Carlson curve with the expertise of a man who co-captained a major electronics firm and held the second highest post at the Department of Defense. (See "The Glory Days Are Over at DoD," *The Electronic Engineer*, Sept. 1970.) "The curve would not, in my opinion, hold true of all countries at all times because a quantum jump could be made by important technology or emphasis on a particular military requirement, e.g., electronic countermeasures."

But Packard hopes for the continuing rise of the curve. "There is much to be gained by emphasizing the capability of our military forces rather than their number," the multi-millionaire electronic executive states, pointing to current use of the so-called "smart bombs" in Viet Nam.

Although Chairman of the San Francisco Bay area "Citizens for Nixon" organization, his final remarks echo in part those of George McGovern. "Whether there is a natural limit to electronics content is hard to say. I would think not, in terms of the further improvement in capability that is possible. I would hope we'd reach a natural limit in our need for larger numbers of weapons with electronics content, and that our industry could devote more effort to a higher electronics content of devices more useful to humanity than weapons of war."

Weighing the intangibles

If nothing else came out of the highly touted "Electronics 1985" meeting than the Carlson curve, and this seems unlikely, the project must be deemed a great success. It gives planners, for the first time, a firm grasp of the potential of the military market amidst the SALT agreements, chronic inflation, and threats of global war.

What must be remembered, as Bruce Carlson brings out, is the old chicken and egg maxim. "One doesn't increase military expenditures per man," states Carlson, "to get a greater share of the electronics market. Leaders decide that a certain degree of strategic capability is necessary and therefore, a certain weapons system is required. To procure that system, it then becomes necessary to spend a certain amount of money which breaks out as expenditures per man."

*The AX is a light tactical aircraft which is presently in a "flyoff" competition between Northrop and Fairchild Hiller; the MSTOL (Medium Short Takeoff and Land) is a transport. Both proposed planes are intended for counter insurgency situations.

Pass the word... our XT wet tantalums are out of this world.

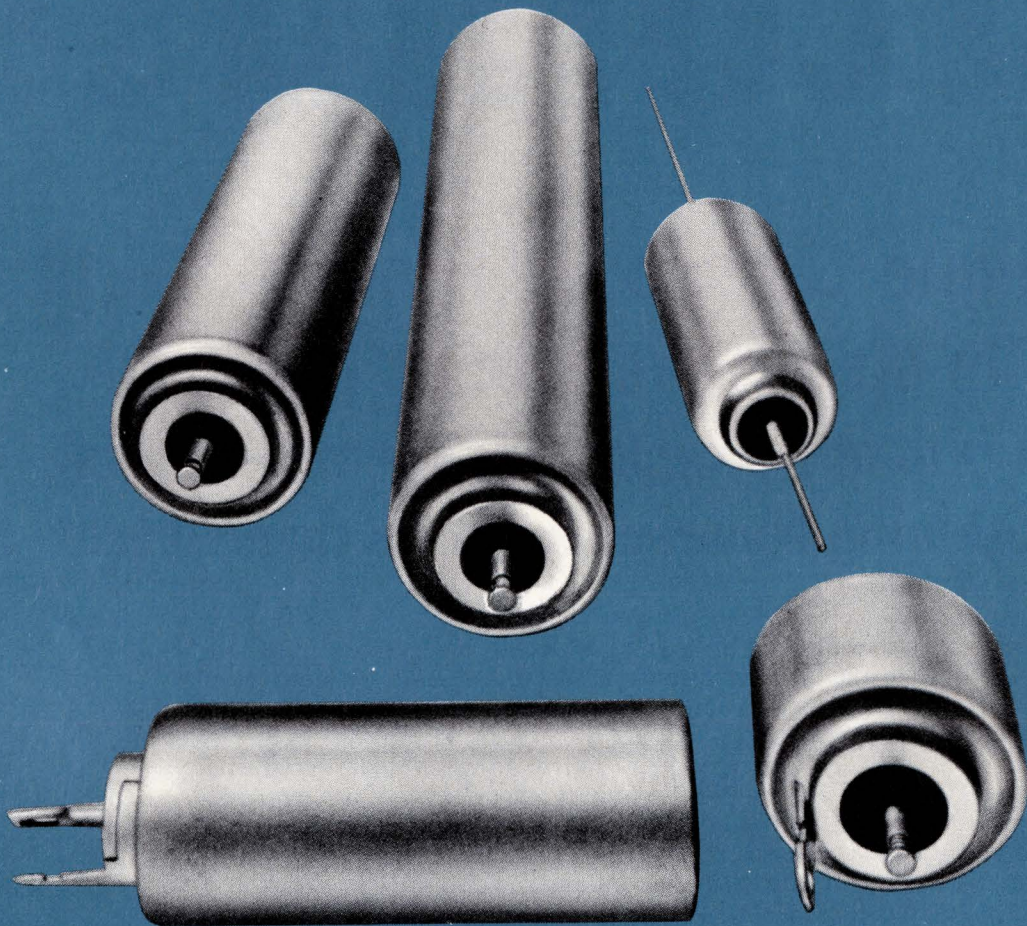

With reliability proven since 1949, our XT series of liquid-electrolyte high-temperature tantalum capacitors is widely used in aerospace, missile, and airborne equipment. Precision industrial components, too.

Rugged construction makes the XT series especially suitable in environmental extremes... from -55°C to $+175^{\circ}\text{C}$. The true hermetic glass-to-metal seal prevents penetration of vapor or liquids in amounts that could damage

internal construction. And double-case construction provides high resistance to corrosion.

Plus... excellent stability, long operating life at high temperatures. Great versatility with a broad line in a wide range of terminal arrangements. Long shelf life. High capacity—up to 2200 mfd in a single small case.

For detailed information and specifications, write for Bulletin 4-84. Or see your authorized Mallory distributor.

MALLORY

MALLORY CAPACITOR COMPANY

a division of P. R. MALLORY & CO. INC.
Indianapolis, Indiana 46208

Electrical and Electronic Components • Sequence Timers • Metallurgical Products • Batteries

automate

**Unique Gardner-Denver Grid-Drill™
drills electronic circuit boards
at a rate of 130 cycles per minute—at total
positioning accuracies of less than $\pm.0006$ "**

No other production machine drills so many holes so accurately in so short a time as this new n/c Gardner-Denver Grid-Drill. Perfect for multi-layer and through-hole plating, for computers of this generation—and the next.

Handles as many as four stacks of panels as large as 15" x 20" each. Drills hole sizes from .010" to .125". Fingertip control adjusts spindle speed from 10,000 to 50,000 rpm. Each spindle is programmed for "use" or "not use," allowing the use of one, all, or any combination of spindles for each cycle. Individual spindles are located in "packages," the spacing and number of which are dependent on the type and volume of work. Packages are customized to your application.

How's this for accuracy? Table location, over a 20" travel, is accurate within $\pm.0006$ ". Repeatability of positioning—within .0003". Spindle runout—within .0005" TIR.

Production rate, including table movement, spindle programming and drilling, is as high as 130 cycles with each spindle per minute.

Gardner-Denver is also the maker of the famous automatic Wire-Wrap® machine. Both machines spectacularly increase production—and lower the cost—of electronic equipment. Call for further information, or write for Bulletins 14-121 and 15-1.



GARDNER-DENVER

Gardner-Denver Company, Quincy, Illinois 62301





MAN6 — .6" high, the MAN6 looks an inch high from across the room. The complete, gapless font makes all ten digits and nine letters unmistakably clear. It should find application in many instruments, consumer electronics, and cockpit displays.

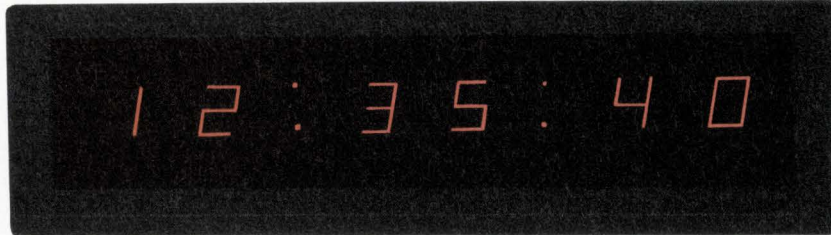

MAN1 — The standard of the industry, the .27" MAN1 is mounted on a 14-pin DIP and encapsulated in clear epoxy. Directly compatible with IC's, it is being used in a wide variety of alphanumeric display sockets. (Shown in a demonstration clock face.)

The Monsanto GaAsLITE Display display.



MDA6101 — Typical of our modules, the MDA6101 single-digit display module requires minimum space in computer, avionic and military systems. Contains a decoder-driver circuit designed to accept four-input BCD (8, 4, 2, 1) code and to provide .27" visual readout of decimal numbers and nine distinct letters. Provides decimal point input and has ripple-blanking input and blanking input/ripple-blanking output terminals for zero suppression and intensity control.

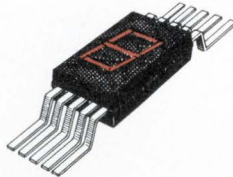

MAN3A — Encapsulated in transparent red epoxy, this small (.115") readout is very useful in desk calculator displays, portable instruments, and film annotation sockets. Displays ten digits and nine letters.

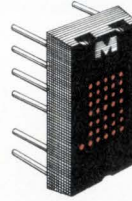

MAN2 — A 5 x 7 light-emitting-diode matrix, the .35" MAN2 alphanumeric displays the full 64-character ASCII code. Finds application as keyboard verifier, avionics display, in computer peripherals and has 2³⁴ bits available for film annotation work.

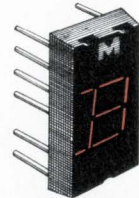

MAN1002 — A .27" 7-segment hexinumeric display, the MAN1002 provides all numbers and the letters A, B, C, D, E, F, H, I, J, L, O, P, S, and U for digital and cockpit readouts that require this capability. Like all our GaAsLITE displays, it is shock resistant and impervious to vibration.

We're displaying our array of light-emitting diode displays to point out the obvious: We've got them all.

Big GaAsLITEs—the new .6" MAN6.

Low-cost little MAN3's, in single-digit or multi-digit packages.

5 x 7 dot matrix MAN2's.

9-segment hexadecimal MAN1002's.

Red, green, and yellow.

And a line of display modules that will answer the industry's felt need: pre-designed display sub-assemblies for nixie retrofit, edge-card plug-ins, etc.

So what more can you look for in solid-state, TTL-compatible,

long-lived light-emitting-diode displays? They're all in stock at our distributors. And the time is right. Get into GaAsLITEs. Display your wisdom.

If you'd like more information on our expanding line of module display products, clip the coupon and shoot it in.

If you need more information on displays, circle the bingo card number below. And if you're smart enough already, just tuck this name into your head when you order displays: **Monsanto Commercial Products Co.**, Electronic Special Products, 10131 Bubb Road, Cupertino, California 95014.

FREE DISPLAY MODULE BROCHURE

Dear Monsanto:

I'm curious about your new line of display modules. Do some contain complete IC driving circuits? Send me the Module Brochure, please.

Name _____

Title _____

Company _____

Address _____

City/State/Zip _____

Monsanto

DIGITAL READOUTS COURSE: PART 2

The competitive confrontation

Choosing a display is not just an exercise in subjectivity and here are the hard facts to prove it.

Stephen A. Thompson, Western Editor

A device known officially as the Numerical Indicator Experimental Tube #1 was dubbed NIXIE (pronounced Nixie) during its development at the Burroughs Corp. The name has continued a synonym for digital display for many years. Like teletypes, core memories, and IBM cards, the Nixie has been obsoleted many times, yet more are sold today than ever before.

It turns out that many people make a distinction between "change" and "improvement." Some non-technical factors, price and familiarity, have a way of tempering breakthroughs as they travel the perilous path from "can replace" to "replaced." The term "inherent low cost" is inherent in technology descriptions. Achieving the inherent is another matter.

Though King Nixie shows no signs of expiring, there are a lot of contenders for the throne. In the past, displays were extensions of tube technology, and used existing capital equipment. Newer types,

specifically designed as displays, are planar, though many are still technically vacuum tubes. The widening acceptance of digital displays has led directly to multi-digit arrays and their obvious economies.

This chapter sorts out display technologies, thanks to contributions from many of the best in the business. Each section attempts to describe the virtues and limitations of a given type. Inter-technological sniping has been discouraged since there are enough advantages, and disadvantages to go around. Your application's match to a given technology's overall cost and characteristics, including decoding, driving, power supply, etc., is more important than any single spec. Considering the display as anything less than a subsystem is a serious mistake on your part.

A critical decision facing many designers, especially in consumer products, is whether they need good or adequate displays. Is million-hour life important? Cars only operate for about 3,000 hours. How many hours will your wife and kids operate that \$100 pocket calculator before it breaks down.

The old adage, believe only half of what you see and nothing that you hear, is a good guideline. Many vendors can pop open a suitcase with several types of displays and their own invariably looks the best. Perhaps we need a course in suitcase electronics. Care-

fully sorted sample shipments may look much more uniform than random production units. The best defense is a thorough knowledge of your system requirements so that you are specifying what has meaning to you.

When the articles begin to discuss the light output, you can refer to the illustration to see quickly what colors are available for a given technology. The relative output vs. wavelength of several light emitters is superimposed on the spectral response characteristic for the eye. You can see that a red display has to be a lot brighter than a green one for you to see it as well. You also cannot filter a color that is not present in the display.

The table at the end of the chapter lists the boundaries of several parameters for displays of all types and the manufacturers who supply them. Cost and decode/drive pricing is shown as best as it is known, but must be considered as a snapshot of a moving target.

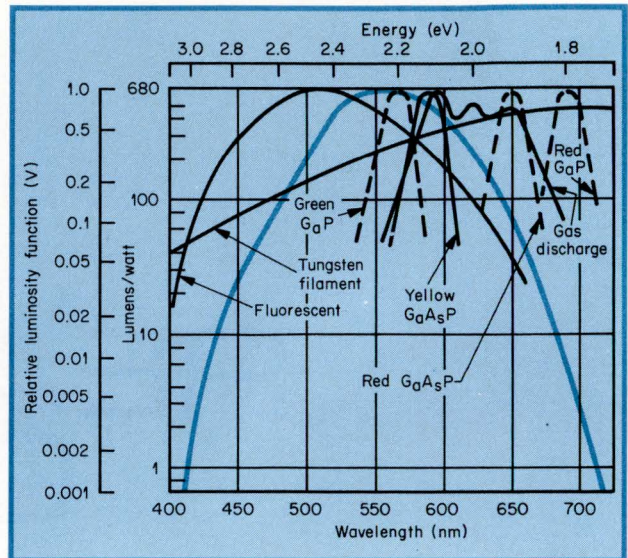

Gas discharge: displays with a glow on

Richard Saxon, Electronic Components Div.
Burroughs Corp.

After 18 years, the Nixie® tube remains the standard against which new displays are invariably compared. The Nixie, a gas-filled, cold-cathode display, has a common anode and several individual metallic cathodes. Numeric tubes contain 10 cathodes which are formed into the shapes of numerals 0 to 9. Alphanumeric tubes have 13 or 15 in-plane cathode segments, combinations of which form the 10 numerals, the letters A through Z, and many special symbols.

Multiplexing causes several tubes to appear continuously energized and reduces overall circuit cost. Generally, a refresh rate of 50 Hz or higher gives flicker-free performance, though lower rates are acceptable if the viewer remains stationary.

When the displays are multiplexed, the maximum duty cycle for each of the N indicators is 1/N. Without brightness compensation, the apparent brightness decreases as N increases. Since the light output of the Nixie is proportional to cathode current, you can maintain the brightness level when the duty cycle decreases by increasing the cathode current. At a duty factor of 5%, and an anode current of 15 mA, a typical B5750 series indicator appears as bright as it would under normal 3 mA dc operation and also

saves total power in the bargain.

The potential economies of multiplexing or time-sharing can only be achieved if a recirculating or sequential memory is already part of the digital system, such as in a calculator. Then the only additional readout components are the tubes, one anode driver per digit, and a common decoder/driver cathode circuit. The savings in cost and power per digit increase substantially as the number of tubes approaches the upper limit of about twenty. The memory also serves the secondary purpose of display refreshing.

In non-multiplexed or dc displays, the entire memory content must be available simultaneously in terms of dc levels, such as the outputs of flip-flop registers. In many situations, a dynamic register would still be required to perform serial arithmetic. Over four or five digits, this dual storage requirement, in addition to separate decoder-drivers for each tube's cathode, makes dc Nixie operation uneconomical.

Multi-digit displays

Panaplex and Panaplex II are representative of planar multi-digit tubes designed as low-cost displays for applications such as calculators and instruments. The different models range from 8 to 18 character positions. Panaplex has nine wire cathodes for dis-

playing seven or nine-segment characters, while Panaplex II uses seven screened thick-film cathodes. Nine segments make it possible to equally center all numerals. In a seven-segment display, the numeral 1 must be off center. Each digit position may also have a decimal point cathode, a comma cathode, or both. Reducing segment current dims either panel without affecting the brightness uniformity.

The most significant aspect of Panaplex II is that it can be driven directly from MOS circuits. Although each panel operates from +170 V dc, the turn-on voltage swing is as low as 25 V, at a peak current of only a few hundred microamps. That is about a third of the usual voltage swing needed in previous gas discharge displays and about one-tenth the other current displays. Power consumption averages less than 5 mW/segment.

There is a delay between voltage application and conduction (ionization), which is a function of the availability of charged particles and the applied voltage. The time required to ionize a digit in a multi-digit display is considerably less than for a single-digit display, since ions are available from adjacent digits. However, the first digit scanned does not receive the same supply of charged particles, particularly with leading zero blanking or at low scan rates. This is a result of the last digit scanned being farthest away, while ions from nearby digits have already decayed. To provide a uniformly bright display, the ionization delay time should be a relatively small part of a digit's duty cycle.

A twelve-digit, seven-segment display with decimal and comma, has 108 active conduction paths, each with its own ionizing and sustaining voltage. In properly fabricated displays the 108 characteristics are extremely uniform, so only a small potential difference need exist between on and off segments. Generally a 25-V swing provides a sufficient margin at useful scan rates.

The minimum cathode voltage swing required to drive the panel increases with supply voltage, cathode current, and scan rate. Since re-ionization time determines the minimum panel voltage, cathode driver voltage swing must be balanced against scan rate and power supply regulation. Although relatively small voltage swings are required, anodes and cathodes in a gas discharge device are separated by the tube drop of approximately 150 V. This necessitates a panel supply voltage and level shifting of cathode or anode drive signals.

All Panaplex life test data accumulated to date indicates longevity is at least as good as that for standard Nixie tubes. *(course continued on page 31)*

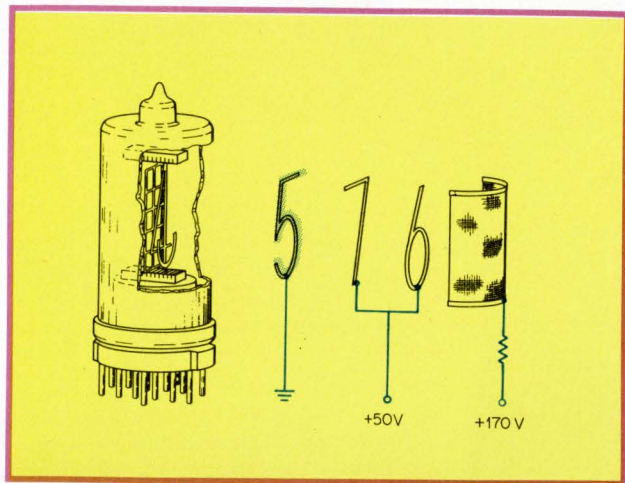

The numeric Nixie. Applying a sufficient negative voltage to any cathode with respect to the anode (~ 170 V) initiates an electrical discharge. Electrons flowing to the anode ionize inert gas molecules, producing light as a glow that assumes the shape of the cathode it surrounds. Off cathodes are biased with a potential 40 to 60 V more positive than the on cathode. This method reduces the turn-on voltage swing as compared to that of the cathodes when held at the anode voltage, and also eliminates the faint fuzzy glow that surrounds them when they are allowed to float.

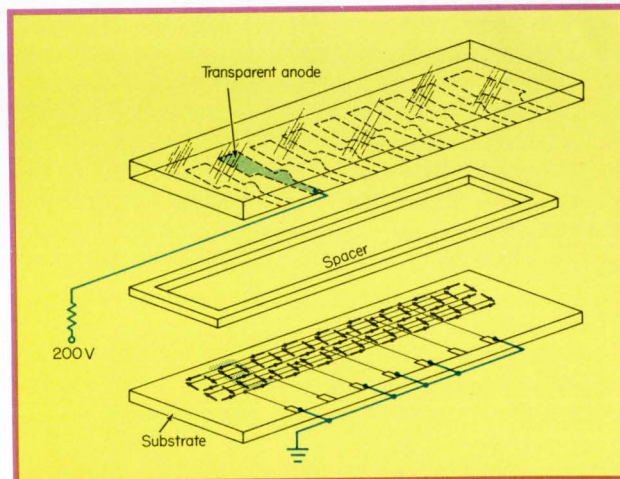

The Panaplex II, designed to operate in a strobed or time-shared mode, appears continuously energized at strobing rates above 80 Hz. A digit position is selected by driving that anode with a positive voltage pulse. At the same time, the appropriate cathode segments are driven negative, causing the potential difference to exceed the ionization voltage and initiating a glow discharge around the selected cathodes. Although similar cathode segments for all digits are at the same potential, glow discharges at those positions are prevented by holding other anodes at a potential below the sustaining voltage. Thus, each cathode-anode pair may be considered as a threshold device in an X-Y matrix. Pairs are selected by simultaneous address in two axes, much the same way a bit in a core memory is selected. Panaplex uses metal strips to form cathodes and screen anodes instead of a conductive glass coating.



864

Sperry displays have more eye appeal!

Panel meters, DVM's, instruments, calculators, computers, business machines and other equipment have more "buy appeal" with advanced Sperry displays† because they have more eye appeal where it really counts — right on the face of your product. These are the unique displays which produce continuous characters, with no irritating gaps or breaks between segments. Sperry displays are also better looking because character shape was determined by human factors engineering — with full consideration given to aspect ratio and form factors.

Sperry displays are brighter, sharper and easier to read than tube-type displays and the much publicized LED's. They have no screens, filaments or "off" numbers to impair readability. In fact, they're so much better looking that it is impossible to show the difference on the printed page. You have to see the actual display to fully appreciate

their excellent appearance. Compare them side-by-side with any other display. You'll find Sperry beats them all.

Sperry displays also come in colors — attractive, easy to read orange or red. Not always true of other types. And Sperry beauty is also more than skin deep. There's the wider viewing angle, low power consumption and proven reliability, not to overlook the cost — \$1.00** per digit in large OEM quantities for either the ½" or ⅓" display.

See for yourself.

Find out how great Sperry displays can look on your product. Check the reader service card for sample ⅓" and ½" self adhesive, printed display strips and complete technical information, or phone or write: Sperry Information Displays Division, Post Office 3579, Scottsdale, Arizona 85257. Telephone (602) 947-8371.



Sperry ½"



Sperry ⅓"



Nixie® ½"



LED ¼"

COMPARE THE BRIGHT, NO GAP APPEARANCE OF SPERRY DISPLAYS WITH ANY OTHER DISPLAY.

SPERRY
INFORMATION DISPLAYS

It's a whole new ball game in displays!

 **SPERRY RAND**

†Patent Pending
*NIXIE is the registered trademark of the Burroughs Corporation.
**Price is \$2.30 in 5,000 digit quantity.

Gas discharge: Planar building blocks

Larry Pond, Sperry Information Displays Div.
 Sperry Rand Corp.

Planar cold cathode, neon gas discharge, seven-segment displays, such as Sperry manufactures, form characters by sinking current through the appropriate segment combinations. They operate in either the dc or time multiplexed mode. Horizontally stackable 1½, 2, 2½ and 3-digit models, in both standard and keep-alive types, allow the user to get any field length (number of digits) he needs.

The keep-alive units have an internal cathode ion source that improves the overall performance in multiplex applications, dark environments, low temperature environments, and in applications using suppressed or blanked zeros. It remains on continuously and is not visible to the observer.

Voltage-current characteristics. These curves for the Sperry SP-700 are typical of all gas discharge displays. For a single isolated element, a very sharp threshold or firing voltage exists at 170 V. Below this limit no current flows and no light is emitted. Once the element fires, operating voltage drops to approximately 150 V and light output becomes a direct function of current, which is controlled by current regulating or current limiting cathode circuits. When additional elements are energized, current begins to flow at a much lower voltage because ions are available from energized elements nearby. The display is considered off (no light emitted) at 110 V, on (light starting to emit) at 130 V, and reaches the normal operating current range at approximately 150 V. Segment currents are measured in microamperes. During multiplex operation, the voltage levels required to fire, operate, and turn off the display are slightly higher than those in the dc mode shown.

Reliability of these displays is excellent. The SP-730 and SP-750 displays are listed as recognized components and under the Underwriters Laboratories categories of UL-478, Electronic Data Processing Equipment and UL-1114, Office Appliances and Business Equipment.

Segmented displays form continuous characters; there are no gaps between the segments. As a result of the pleasant overall aesthetic appearance, these displays have found wide application in consumer products such as digital clocks and electronic calculators.

The color is the broadband neon orange. At normal operation of 200 ft-L, they can be read in direct sunlight, or in a 10,000 ft-L field. The brightness may be varied from less than 100 to greater than 500 ft-L by varying segment currents or duty cycles.

(course continued on p. 34)

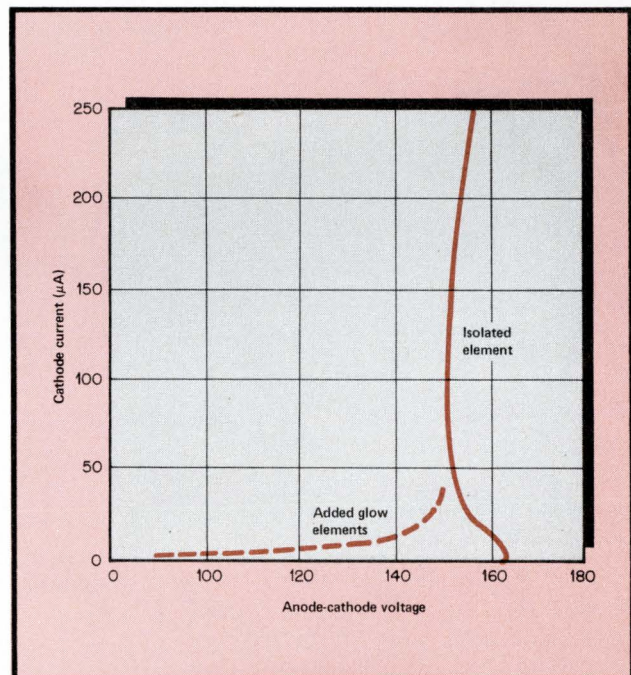
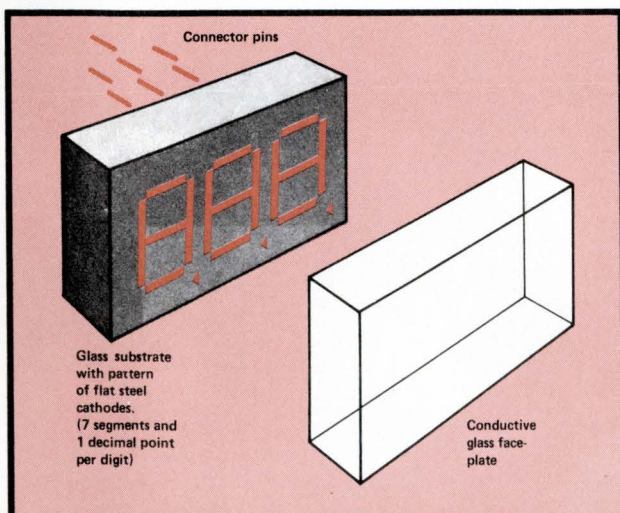

◀ **Low cost potential** of planar gas discharge displays. Parts consist of glass, metal, and neon gas. Each character has seven metal cathode segments on a glass substrate. The common anode is an invisible conductive coating on the glass viewing surface.

Two new P&B series
dry reed relays
give designers
9,627 options.

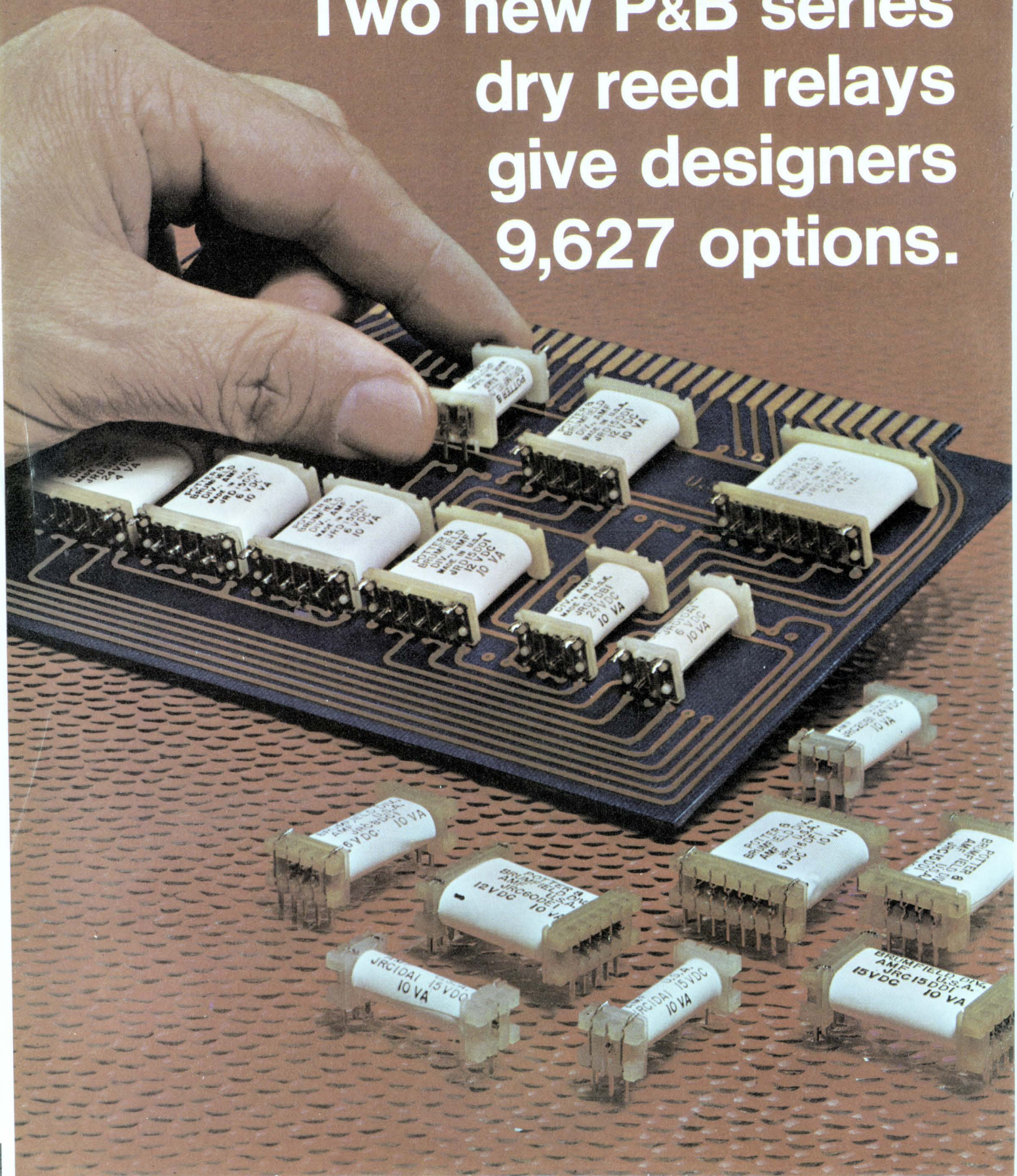

Now, your design work is simplified, your choice of dry reeds is broadened, with our new JRC and JRD series. And P&B Quality comes as a bonus.

With 9,627 options, these two new series of dry reed relays present printed circuit board designers new opportunities for creative engineering.

Each is miniature in size with terminals spaced on 1.0" centers.

Each offers a choice of contact arrangements and coil terminals.

Each is available now from authorized P&B electronic parts distributors.

Importantly, you get P&B quality at competitive prices in all quantities.

JRC reeds have terminals arranged for .100" x 1.00" grid spacing and feature a low profile (.36") to permit close stacking of pc boards. In-line termination is in keeping with the industry trend, and the JRC coil leads terminate at any of four corners. The terminals are supported by the bobbin, and any forces encountered are transmitted to the stand-off flange to prevent stressing the glass seal of the capsule.

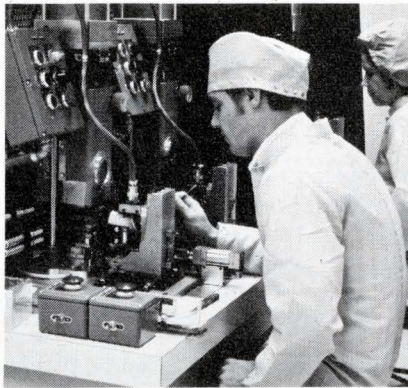

P&B precision assembly machines make it possible to control gap variance in reeds to within 2/10,000ths of an inch. (1/10th the thickness of a human hair.)

Contact configurations are available in Form A (SPST-NO), Form B (SPST-NC) and combinations of Forms A and B. For DC restive loads, the contacts have a maximum rating of 10 watts, .5 ampere, and 200 volts. Typical operate speeds at 25°C are 1 millisecond including bounce for pick-up and .05 millisecond drop-

out. Available coil voltages range from 3 to 48VDC.

The JRC series may be ordered with 1, 2, 3, 4, 5 or 6 cavity bobbins.

New JRD dry reed relays offer design engineers the option of .150" x 1.00" grid spacing. Slightly larger than the JRC package, the JRD's are similar except they offer, in addition to Forms A and B, a true Form C (SPDT) contact configuration. JRD's may be ordered in 1, 2, 4 or 6 cavity bobbins.

JRC and JRD open style, dry reed relays are produced to exacting tolerances and provide design engineers with a wide selection of contact configurations for logic circuitry, instrumentation and low voltage applications. Both series are available with or without magnetic shielding.

For complete information, or advice, and for your copy of the 226 page relay catalog, write Potter & Brumfield Division, AMF Incorporated, Princeton, Indiana 47670. Or, simply call 812 385-5251.

Replacements for IBM Reed Relays. While not identical in all aspects, JRD Reed Relays have the same terminal spacings and electrical characteristics as those manufactured by IBM.

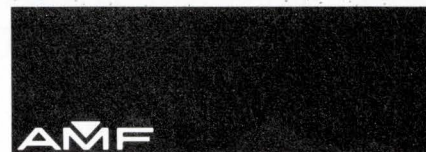
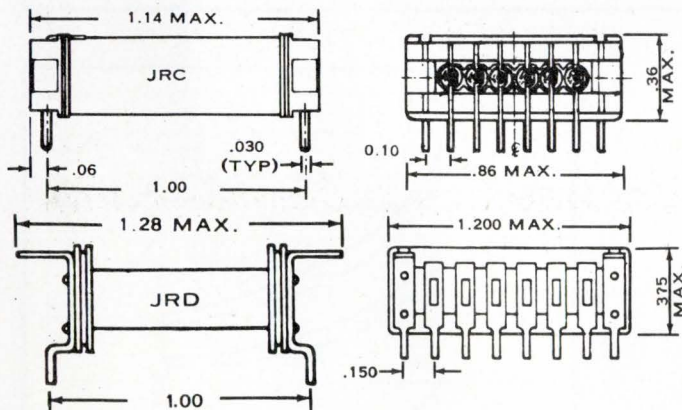

Potter & Brumfield

**P&B makes more of more kinds of relays
than anybody in the business.**

Anybody.

Circle Reader Service #16

Incandescents: directly viewed filaments

P. L. Farine, Special Products Engineering and Services
RCA Corp., Somerville, N.J.

Incandescent filament displays, such as RCA's Numitron[®], operate in ac, dc, or multiplex modes. Such displays provide the following advantages:

- high-contrast, clutter-free display viewed against a dark background
- wide viewing angle (120°)
- use standard low-cost sockets or solder directly onto PC boards
- freedom from induced or radiated interference
- compatibility with IC decoder/drivers (2.5-5.0 V)
- moderate to low power consumption (500 mW-

175 mW).

Their form factors vary from flat rectangular packages to miniature and subminiature vacuum tube envelopes. These displays generate enough light to be used in strong sunlight, and users have a wide color filter choice since the output spectrum covers the whole visible range. Filters can enhance the contrast ratio, causing segments to appear as sharply defined lines, or can diffuse the line width.

Since directly viewed incandescents operate at lower temperatures than incandescent lamps, they are far more reliable. Their ruggedness and proven reliability has served well in avionics, panel meter scales, cash registers, tachometers, clocks, and industrial controls. Reinforcing the ruggedness is the

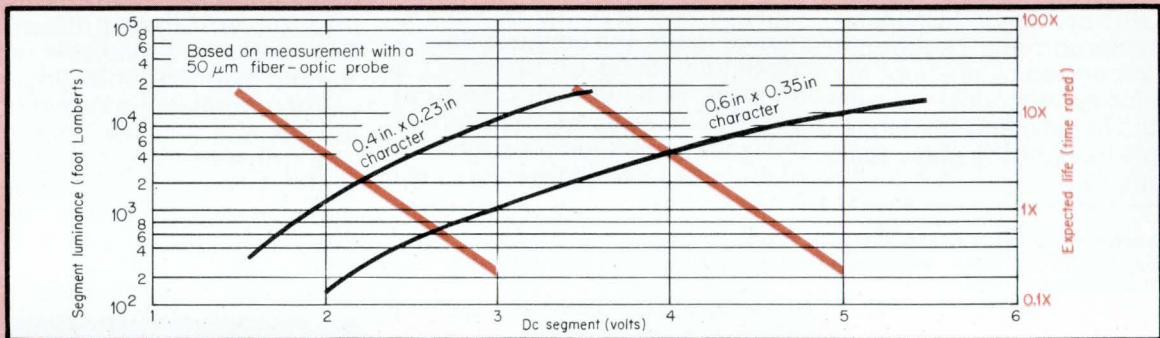

Segment luminance and life characteristics. A wide range of voltage variable luminance is possible by making a tradeoff with filament life. Normal expected life is about 100,000 hours.

Peak segment current and voltage at two brightness levels is shown as a function of duty factor. Integrated power averages an almost constant 107 mW and 35 mW per segment for normal brightness, and about 74% of that for one-half brightness.

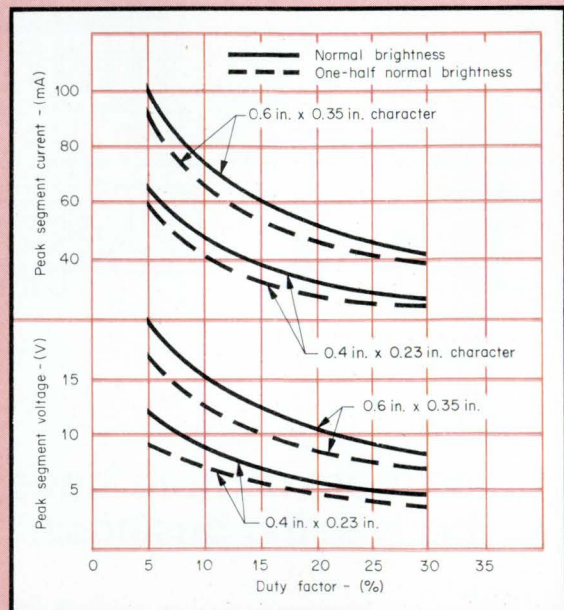

structure with pins protruding through a high contrast black substrate to rigidly support the low mass, single-helical coil segments. Since segment mass is extremely small, shock ratings of 200 g and vibration of 20 g in the 60 to 500 Hz region is obtainable.

Operating at temperatures of 1100 to 1350°C, compared to 2500°C for a tungsten filament lamp, the vapor pressure of the tungsten alloy wire is nearly zero, so evaporation is negligible. The low temperature keeps other parts relatively cool, minimizing outgassing. Typical envelope temperatures run 14°C above ambient.

Since coil segments are essentially wire-wound resistors, changing the voltage varies the brightness. Filament wire diameter and coil size are so small that the temperature rise time is 8-15 ms and the fall time is 10-20 ms. In-rush current does not degrade life, for while it may exceed rated current by a factor of five to eight, its duration is short (approximately 10 ms) and it declines to the steady-state value as the filament warms up. Temperature never exceeds the

steady state value. Pulsing the segments during strobing (at the appropriate duty cycle), also does not degrade life. The long thermal time constant helps to smooth out flicker. To avoid flicker, operate at 40 Hz or above.

Some filaments permanently sag after a sustained over-voltage. Manufacturers usually burn in the displays at rated voltage to relieve stresses, detect any sag, and call out early failures. Differences in sag resistance in readouts from different manufacturers occur because each has his own proprietary coil treatment.

Cost-effective multiplexing is possible at pulse voltages significantly higher than maximum recommended dc values. However, exceeding the breakdown voltage rating and the maximum output current rating of the decoder/driver must be avoided. Since the incandescent segments are resistors, isolation diodes are needed in series with each one to prevent simultaneous lighting of coil segments in adjacent devices. *(Course continued on next page)*

Bastard BOKER'S WASHERS Spacers and Shims

**FREE 48 Page
Stock Die List**
Hundreds of Sizes

Any quantity
from Stock Dies
NO DIE COST



ANY Material
I.D., .027" to 1.637"
O.D., .086" to 1.935" Thickness .004" to .190"

Over 1600 stock die sizes. Low die cost for non-stock sizes. Send print or phone for prompt quote.

BOKER'S COMPLETE STAMPING SERVICE

Tooling, production, welding, secondary operations, inspection, metallurgical lab. Quantities from a handful to a carload. Send print for prompt quote.

Stamping Specialists **BOKER'S, INC.** Since 1919
Phone 612-729-9365

3106 Snelling Ave S Minneapolis, 55406

* Low Cost Isolated Data Couplers

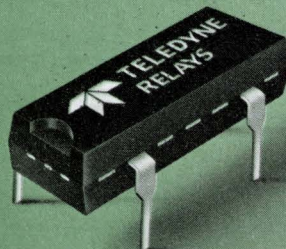

100% SOLID STATE DIP RELAYS FOR

- Computer interfacing
- Telecommunications

Teledyne offers a broad family of SPST isolated data couplers for switching analog or digital signals and AC or DC power.

Model 640-1 Switches bipolar analog or digital signals up to $\pm 50V$ at ± 100 ma from logic inputs. Up to 100 KHz switching rate with a saturation resistance of 5 ohms max. Dielectric strength 1000 VAC(P-P).

Model 641-1 & 641-2 Switches 115VAC(-1) or 230VAC(-2) loads up to 1 amp from logic inputs. Dielectric strength 2500VRMS.

Model 643-1 & 643-2 Switches 60VDC(-1) or 250VDC(-2) loads up to 0.4 amps from logic level inputs. Up to 100 KHz switching rate with saturation resistance of 5 ohms max. Dielectric strength 1000 VAC (P-P).

Write or phone for additional information.

**TELEDYNE
RELAYS**

3155 West El Segundo Boulevard,
Hawthorne, California 90250
Telephone (213) 679-2205

* Less than \$5.00 at 1000 pcs. and \$3.00 at 10,000 pcs. for most models.

Incandescents can be indirect

Stephen A. Thompson, Western Editor

Incandescent filaments can function strictly as light sources, with other components determining the shape and size of the characters. Two methods are the back-lighted and rear-projection displays.

Back-lighted displays use individual lamps for each character segment. The lamps fit into highly reflective cavities and light travels to the viewing surface through an air cavity, polycarbonate pipe, or fiber optic bundle. With this method, virtually any size, shape, and color is possible.

Many lamps are IC voltage compatible, and lifetime and brightness are both voltage variable. Packages are engineered for heat dissipation, easy color filter changes, quick lamp replacement, end-stacking to any length, panel mounting, and have plenty of room for decoder/driver circuitry. They mate to cable connectors, PC boards, IC sockets, etc.

Because of sufficient contrast, displays can be viewed in direct sunlight. The fiber optic types concentrate light into relatively small areas efficiently, permitting very bright displays. Also, this lets you de-rate the lamps for longer life. Only light that enters a fiber within an included angle of about 67° is transmitted, so only light within that angle is available at the other end. Fiber ends must be coated with a highly refractive compound to widen the viewing angle.

In some cases, LEDs are replacing lamps in back-lighted displays. They offer better shock and vibration protection than standard incandescent lamps.

Rear projection

Rear-projection readouts use an incandescent lamp and lens matrix in association with high contrast film to generate displays on a rear-projection viewing screen. They were the first single-plane, digital display modules.

These displays feature high contrast and allow engineers a wide selection of voltage and current combinations, as well as character sizes, shapes, and colors. In general, the projection readout requires a voltage of 28 V or less, and a 100-300 mA power supply. The nature of the readout is such that panel space per decade is minimized with some sacrifice in depth.

Because anything photographically reproducible can be displayed, the display has a message-per-lamp

(continued on page 38)

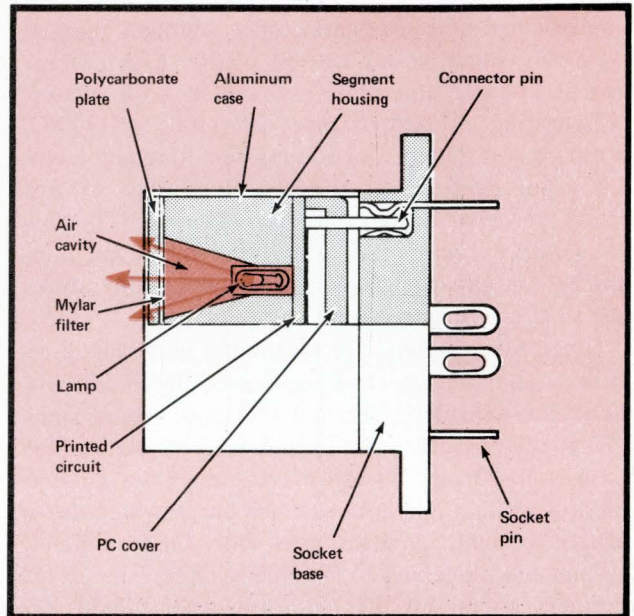

A typical back-lit display, courtesy of Readouts Inc.

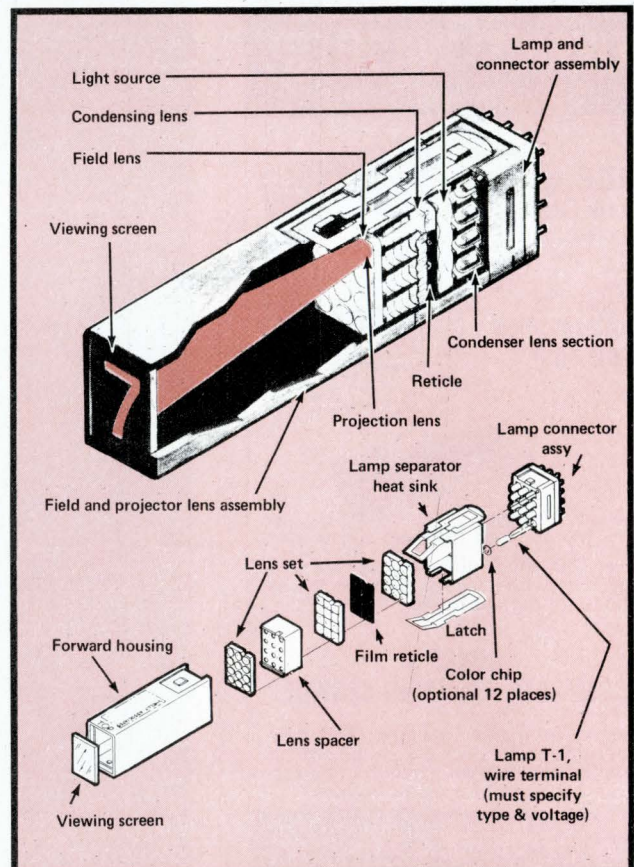

Rear-projection display, courtesy of Shelly Associates, Inc.

We've turned the world of displays upside down

NEW PANAPLEX II™ PANEL DISPLAY

lowest cost... lowest power MOS compatibility

- Lowest power—average power less than 5 milliwatts per segment
- Lowest cost—\$1.00 per digit*
- MOS compatibility—cathodes and anodes can be driven from MOS circuits

There is a lot of talk about displays—new technologies, new innovations, a lot of good new things just “over the horizon.” But the fact is that the PANAPLEX II panel display, representing a technology that grew from the NIXIE® tube, is the best numeric display available now.

Only PANAPLEX II panels switch on voltage and current low enough for direct MOS compatibility Cut power requirements to milliwatts And cut costs down to \$1.00 per digit.* Characters are bright and readable and can be custom-tailored for numerous applications . . . including annunciators requiring special fonts. We packed 8 to 16 digits into a 0.2”—thick (not including tubulation) in-plane display panel for calculators, cash registers, special instruments, you name it.

PANAPLEX II PANEL DISPLAY — More than another new readout, a whole new way of looking at numeric displays.

For additional information write: Burroughs Corporation, Electronic Components Division, P.O. Box 1226, Plainfield, N.J. 07061; or call our special applications assistance number, (201) 757-3400.

*50,000 tube quantity.

Leader in the World of Displays

Circle Reader Service #22

Burroughs



capability. It can display a function or meaning assigned to a set of numeric data, or display specific instructions and formation to an operator without referring to auxiliary codes or cross-reference charts. It is failsafe, in that if a lamp fails, nothing is displayed, rather than incomplete or incorrect data. Since only lamps are replaced, not entire characters, the maintenance cost is low.

Non-standard display arrays carry a cost of artwork and film that must be included as part of the acquisition cost. The further off-axis a character gets, the more distorted it becomes because the pro-

jection screen is only on-axis with the center of the module. The result is keystoneing, the effect you notice when you tilt a slide projector and one end of the picture becomes wider than the other.

Compensation to prevent keystoneing at the artwork stage is expensive. The effect can be minimized by moving the most distortion-sensitive images toward the center and making them smaller. While the effect is still there, it is not as noticeable. Those displays that use one lamp and lens, and move the film so that the character is always on-axis, overcome this, but introduce moving mechanical parts.

Vacuum fluorescent: the segmented CRT

R. T. Raago, Tung-Sol Div.
Warner Electric Corp.

The beauty of the vacuum fluorescent readout is that next to the light bulb it is the simplest electronic display. With low voltage and current requirements, it is adaptable to portable, battery-powered equipment. It has MOS compatibility, full color versatility, and

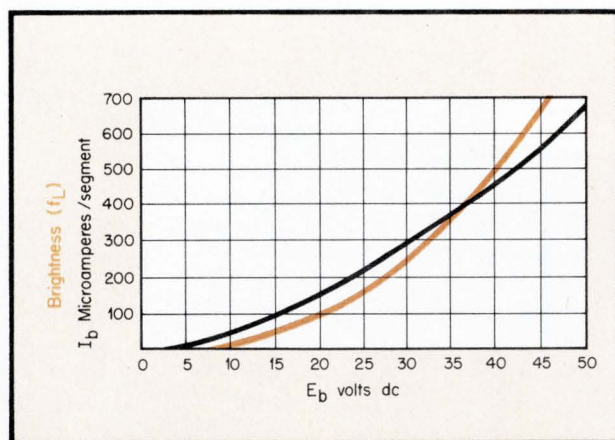

Power and brightness characteristics per segment of typical vacuum fluorescent tube. Light output is near 150 ft-L at an anode voltage, E_b , of 25 V. At this operating point, the total power required for a figure 8 is 117 mW: 45 mW for the display and 72 mW for filament power, which is always on. Brightness saturates between 60 and 80 V and 700-800 ft-L, but substantial segment heating takes place, decreasing phosphor efficiency. A brightness of 50 ft-L is achievable at about 15 V.

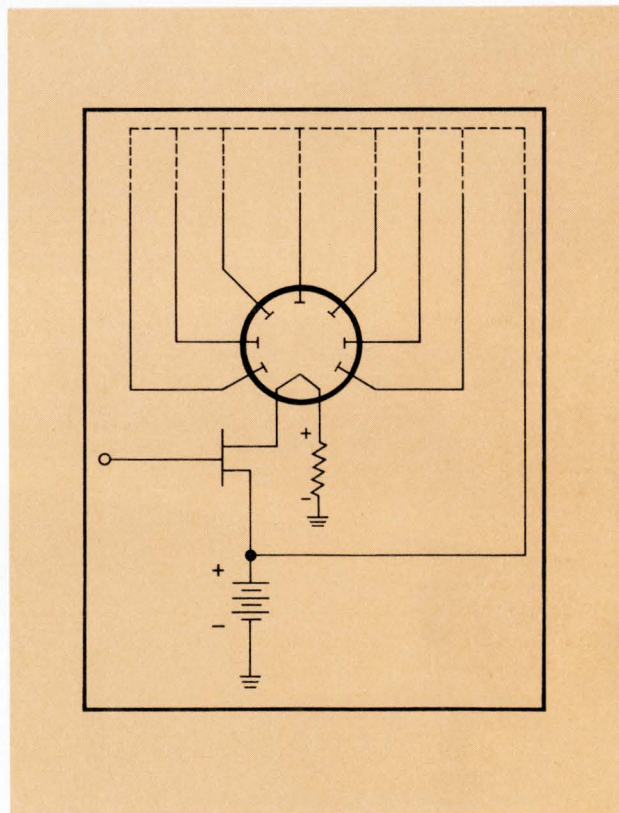

One method to accomplish strobing is to turn the transistor on and off. As long as the transistor conducts, the filament and series resistor act as a voltage divider. The filament is lighted and at the same potential as the anodes, thus the readout is not conducting. Turning the transistor off drops the other side of the filament to almost ground potential and the readout begins to conduct.

can be multiplexed. This display is a vacuum diode with a common cathode consisting of two very fine parallel wire filaments. Typically, seven phosphor coated anodes form a figure eight at a predetermined distance behind the filaments, and single digit or multi-digit array structures are sealed into glass envelopes.

Connecting the proper positive voltage to any combination of these anodes with respect to the cathode causes electron bombardment of the selected phosphors, which emit light to generate one of 10 digits or 14 letters. Since all characters are formed in one plane near the tube wall, the parallax-free viewing angle exceeds 150°, while the viewing distance can exceed 40 ft.

Though the filaments are between the viewer and the anodes, they are very small, about 0.4 mil, and operate from 600 to 700°C, just at the threshold of incandescence. They disappear completely when the background segment is illuminated. Since they are spring loaded, they maintain their geometry when they elongate from thermal expansion.

The use of different phosphors for different colors is impractical because very few phosphors operate efficiently at the low accelerating voltages required. Using filters makes all readouts interchangeable in

any display and keeps manufacturing costs to a minimum.

Segment current follows the typical 3/2 power law, so brightness is proportional to anode voltage. The ability of MOS to handle 30 V at currents to a few milliamps, and the ability of the fluorescent display to respond, result in an ideal marriage between them.

Thermal inertia of the filament prevents instantaneous turn-off by opening the cathode circuit. Therefore, strobing must work on switching the potential differences between anode and cathode from zero volts to the operating voltage. By taking advantage of the thermal inertia concept, we can bias a common filament supply for several tubes to anode potential, and as the logic information is fed into each readout, reverse the bias.

These displays have the following advantages:

- full alphanumeric capability with 14-16 segments
- wide range of character sizes
- many digits per envelope
- continuous-looking characters
- variety in font and style
- voltage compatible with MOS or direct operation from 115-V lines.

LEDs

William Otsuka

Monsanto Co., Cupertino, Calif.

Most light emitting diode (LED) readouts are fabricated from discrete diodes arranged in bar segment arrays or dot matrices. The forward biasing of selected groups of diodes lights up the desired character. Though small monolithic displays do exist, material cost prohibits this approach much above a 0.1 in. character height.

Being ICs themselves, LEDs are obviously IC compatible and therefore easily drivable. Several displays offer LEDs and decode/drive electronics in the same package. Voltage and current levels are low; size can be very small when needed; and although flat packages are the rule, even DIPs are used. Brightness is current variable, permitting use in a wide range of ambient lighting. Because the emission spectrum is very narrow, external optical filters can provide character enhancement and permit use in very high illumination environments.

Operating principles

Semiconductor compounds are preferred for LEDs over the more familiar elemental germanium or sili-

con materials, because their p-n junctions form much better light emitters. A semiconductor-theory explanation for this significant difference can be made in terms of energy-band properties.

Consider large current (electron) flows in forward-biased p-n diode junctions. In germanium and silicon—called “indirect gap” materials—electrons traveling from the n-side conduction band to the p-side valence band cannot maintain their momentum, and they give up most of their energy in the form of lattice-vibration heating (phonons). In GaAs—called a “direct gap” material—electrons can make the transition directly without changing momentum, so they can give up most of their energy in the form of quanta of light (photons). Ternary compounds of GaAsP with less than 45% phosphorous are also direct-gap materials; with more than 45%, they are less efficient emitters and special processing such as nitrogen doping is used to improve emission characteristics.

Light output is monochromatic, i.e., covering a very narrow wavelength band. Wavelength, or color, depends upon a material's band-gap energy value.
(continued on next page)

FUSES

for protection of Electronic Devices

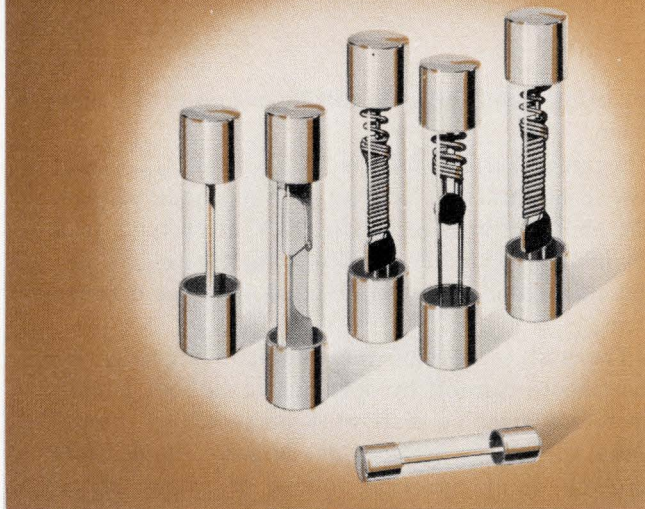

There is a complete line of BUSS Quality fuses in $\frac{1}{4} \times 1$ inch, $\frac{1}{4} \times 1\frac{1}{4}$ inch, and miniature sizes, with standard and pigtail types available in quick-acting or dual-element slow blowing varieties.

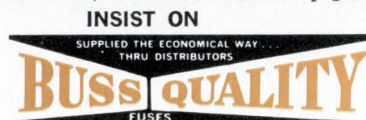

Write for BUSS Form SFB

Bussmann Mfg. Division, McGraw-Edison Co., St. Louis, Mo. 63107

Tron Rectifier Fuses

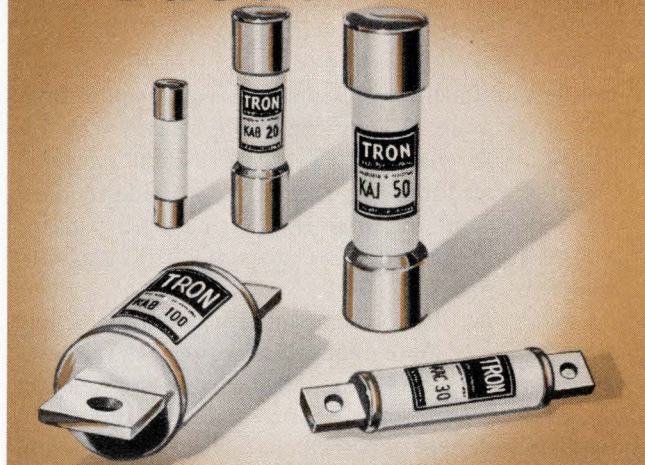

Available in sizes from $\frac{1}{2}$ to 1000 amps for voltages up to 1500, TRON Rectifier Fuses are ideal for protecting variable speed drives, inverters, battery chargers, plating power supplies, power controls, and any other application where fast opening and great current limitation are required.

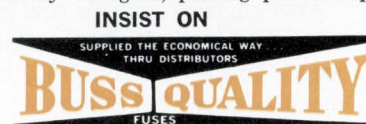

Write for BUSS Form TRFS

Bussmann Mfg. Division, McGraw-Edison Co., St. Louis, Mo. 63107

BUSS: The Complete Line of Fuses and . . .

Noticeable light output also accompanies the high reverse-current flow induced by a reverse-polarity breakdown voltage. However, the light emitting mechanism is quite different, and operating an LED this way can damage the device.

Turn-on and turn-off speeds of much less than 1μ s are inherent because of the spontaneous nature of the light emitting mechanism. Light output increases with drive current, which depends directly upon the active emitting area. Since a smaller emitting area

reduces the drive current needed, it is possible to achieve a larger character size by optical means, without needing significantly increased current. All kinds of reflecting and magnifying packaging are used to maximize available light.

Direct operation of LED readouts is practical in some simple applications. In most cases, however, considerable circuit economy is achieved through use of multiplexing techniques and pulsed rather than steady-state operation.

LED materials

Dick Ahrons,

Opcoa Inc.

The two major commercial LED materials are gallium arsenide phosphide (GaAsP) on a host material of gallium arsenide (GaAs), and gallium phosphide (GaP). Both types are good red emitters, while green emitting products are attainable from GaP.

In the visible spectrum, GaAs or GaAsP is

opaque. From green through red, GaP is transparent. This feature allows light to reflect many times inside the crystal, without appreciable absorption, and finally escape. This transparency contributes to the material's efficiency.

Doping GaP with zinc oxide forms red light-emitting iso-electronic traps. The quantum efficiency, i.e., photons out to electrons in, is about 1%, compared

to 0.15% for GaAsP. Because the response of the eye differs with wavelength, the 10:1 power efficiency advantage of GaP over GaAsP is reduced to 3:1/4:1 in luminous efficiency. For a typical small pellet, GaP emits about 5 millilumens vs. about 1.5 millilumens for GaAsP, both at a drive current of 20 mA.

Because GaAsP is opaque, the p-n junction must be close to the top surface, making the device a surface emitter. Most segment (bar) readouts use dif-

fused junctions in the form of squares or dots on the bar of GaAsP. In the case of GaP, which is transparent, the junction does not have to be close to the surface. A small 0.015-in. chip can be used in a rectangular reflector to obtain a bar of light 0.15 x 0.025 in. by making use of light emitted from the sides of the pellet as well as the top. Since only one small LED pellet is used in each segment, this method promises low cost readouts.

The promise of liquid crystals

Edward Kornstein & Nunzio A. Luce

Optel Corp., Princeton, N.J.

Liquid crystal (LC) displays do not generate light; they scatter ambient light. This feature provides significant advantages, such as low power and use despite high ambient lighting. Because of the flexibility

of size and shape, advertising displays, scoreboards and annunciator panels can all be made with liquid crystal. All indications are that liquid crystals could be the lowest cost display in a few years.

The hurdles

The key ingredients required for a viable and suc-

.. Fuseholders of Unquestioned High Quality

FUSEBLOCKS



There is a full line of BUSS Quality fuseblocks in bakelite, phenolic, and porcelain, with solder, screw-type, or quick-connect terminals.

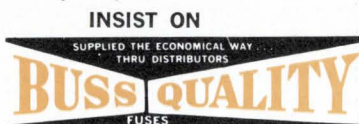

Write for BUSS Form SFB

Bussmann Mfg. Division, McGraw-Edison Co., St. Louis, Mo. 63107

FUSEHOLDERS



BUSS has a complete line of fuseholders to cover every application. It includes lamp indicating and alarm activating types, space-saving panel mounted types, in-line holders, RFI-shielded types, and a full line of military types. Most are available with quick-connect terminals.



Write for BUSS Form SFB

Bussmann Mfg. Division, McGraw-Edison Co., St. Louis, Mo. 63107

cessful LC product will be materials development to extend the temperature range; packaging techniques to extend the life; and electronic interfaces to allow direct MOS IC drive.

In general, liquid crystal molecules are rod shaped and have an electric dipole movement that controls their behavior in an electric field. The most used electro-optical effects are dynamic scattering and field effects.

Fabricating good LC material presents a real challenge. It must be very stable and very pure with precise levels of uniformly distributed dopants added to produce the ions for dynamic scattering. Special surface agents and treatments must be included to in-

sure that the molecules maintain their alignment at the electrode boundaries. The useful operating range is typically about 0 to 55°C. The package must also be clean and hermetic. For uniform response times, plate spacing must be held constant at 10% over the active area.

Electrical phenomena

Long life requires ac drive in the range of 20-40 Hz, though materials can operate from 16-100 Hz. Dc driving results in unwanted electrochemical processes, such as electroplating of the electrode structures.

Dynamic scattering material is linear, i.e., no

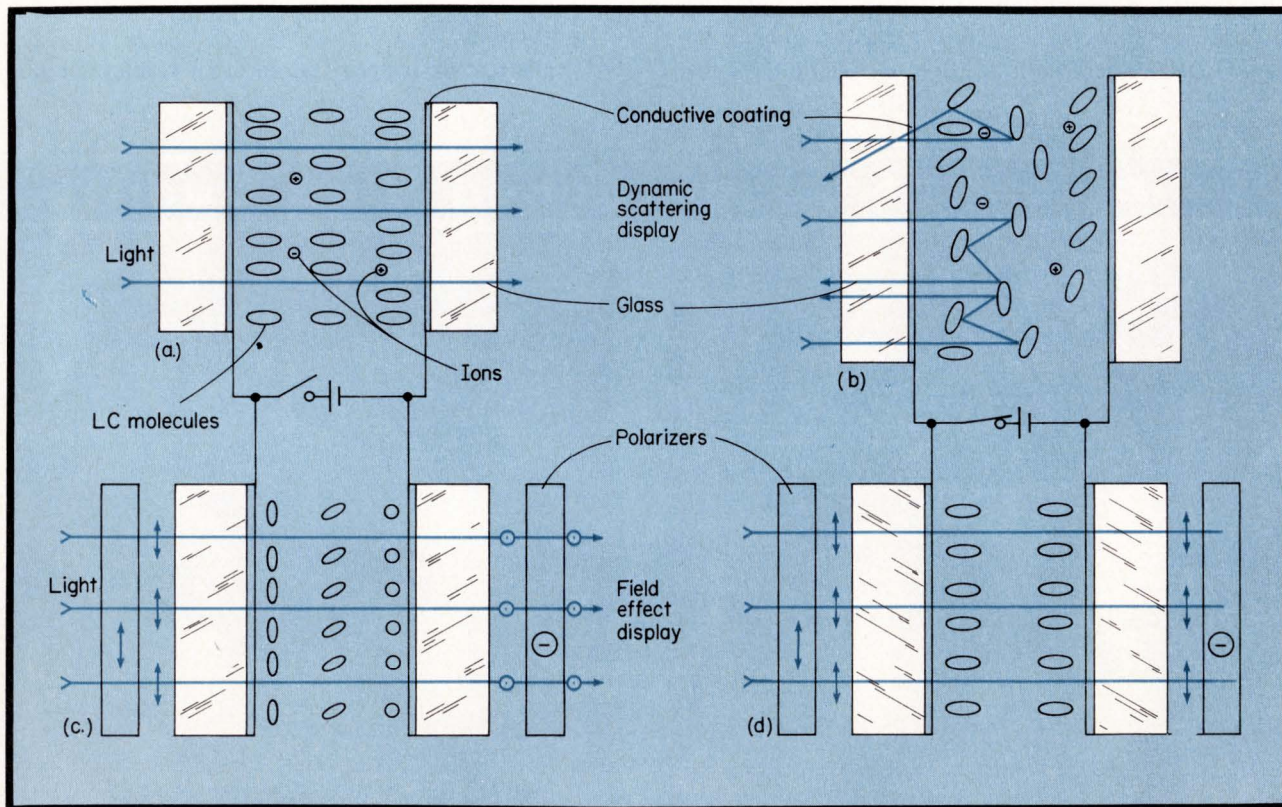

Liquid crystal display mechanisms. Consider that an observer looks from the left. In the dynamic type (top), with no voltage applied (a), molecules line up so that light passes through. When display voltage is applied (b), molecules tend to be perpendicular to the light and ion migration disorders them, causing light scattering in the activated areas. In the reflective-type display, the second electrode is a highly reflective material such as aluminum. In transmissive displays, the observer is to the right and both conductors are transparent.

In transmissive field-effect displays (bottom), electrodes are treated to cause molecules to line up as in (c). Polarized light rotates 90° within the liquid and passes through a crossed polarizer on the other side. An applied field (d) lines

up the molecules so that light is unaffected and blocked by the crossed polarizer. This provides an observer to the right with a light display on a dark background. Paralleling the polarizers reverses the contrast. A reflective display can be made by placing a mirror after the second polarizer.

Dynamic displays take 12-30 V and currents of 20-30 $\mu\text{A}/\text{cm}^2$, with some watch displays as low as 6 $\mu\text{A}/\text{cm}^2$. Field effect types operate down to 5 V and draw essentially zero current. In dynamic reflective displays, double scattering provides 140° or more of viewing angle. Dynamic transmissive types give less because of the single light pass. Field-effect displays have smaller viewing angles because of the polarizers, especially in the reflective mode.

sharp voltage threshold. In addition, each segment is electrically hundreds of megohms of resistance, shunted by tens or hundreds of picofarads capacitance. Capacitive coupling and lack of sharp threshold results in crosstalk between segments. Since standard multiplexing circuits are useless for these reasons, special techniques are being developed. Because the display requires an ac drive, bi-directional switches are needed to activate segments.

Lifetime

Properly purified and handled liquid crystal materials last many years, so life is strictly a function of manufacturing technique. Tests indicate that 10,000 h life is readily achievable and 40,000 h appears to be possible.

The failure mode seems to be indicated by gradual yellowing and contrast degradation. Displays subject to failure can be identified by very carefully measuring the current drain over several weeks. If current tends to rise, shorter life is probable.

Temperature and possibly fatigue, over a period of time, degrade the capability of molecules in field-effect units to return to a specific orientation when the field is removed. This shows up as an inability to turn a segment off.

Mounting

Reflective displays must be carefully mounted to prevent specular (direct) reflection of incident light into an observer's eye. This is possible for instruments with a fixed relation to an observer, such as calculators. Units subject to varied angles of incident light and viewing should be position adjustable.

Since an LC modifies ambient light, contrast ratios have no meaning unless the measurement technique

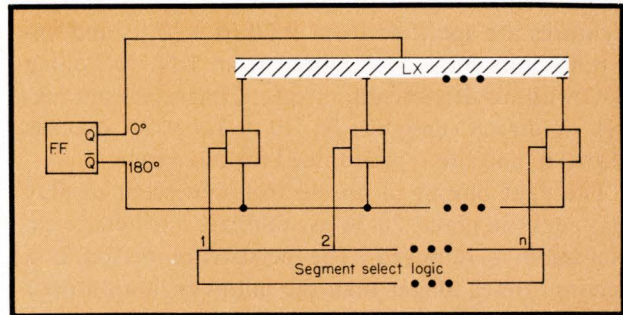

A simple ac switching circuit. The bi-directional switches each have a p-channel and an n-channel FET connected in parallel. One output (Q) of the flip-flop, used as the ac source, is connected to the display common. The other output (Q̄) connects to the common side of all the switches. The switch outputs are connected to the display segments. When a switch is turned on, current flows through the display in one direction for one half cycle and reverses on the next. Since the switches are symmetrical, there is no apparent dc offset on the display. Switch leakage in the off state must be less than 10 nA because of the high impedance of the display segments.

is specified. One method is to set a detector normal to a reflective display with a collimated light source at 45°, and measure segment brightness with the display on and off. Under these conditions a ratio of 10:1 is visually satisfactory and 15:1 or 20:1 gives an excellent and extremely crisp looking display.

Even though LC displays can be driven directly from MOS chips, those used for other types of displays are not appropriate. This means that special chips must be designed and the instrument functions may as well be included in the chip. This has been done in the timepiece and DVM markets where the designer has buried the decode/drive circuit cost in the LSI chip. Interface circuits for existing designs may fall into the 50-75¢/digit category.

Electroluminescent displays

R. D. Webb

Sigmatron, Inc., Santa Barbara, Calif.

Certain solids exhibit electroluminescence, i.e., light emission when an electric field is applied. Micron-thin light-emitting films (LEF) of such polycrystalline

phosphors are relatively insensitive to temperature, variations, shock, and vibration. Displays made from these films have virtually no limit as to size or form. For example, displays based on ZnS:Mn powder have been made with digits from 0.03 to 10 in. and in

arrays containing up to 80-digits. Operating temperatures are specified from -70 to $+70^{\circ}\text{C}$, and operating units have been cycled from LN_2 to boiling H_2O with no detrimental effects. Characters are legible in direct sunlight. At 10 ft-L, MTBF exceeds 25,000 h, and life is guaranteed for one year.

The light output of an electroluminescent display that peaks in about $20\text{-}30\ \mu\text{s}$ stabilizes until electrical excitation is removed. The persistence period is a hundred times longer than the initial excitation peri-

od. This is very important because it means that the LEF has an integral memory of 2-3 ms and is ideal for multiplexing with a 1% duty cycle.

Brightness can be controlled by frequency, duty cycle, and/or amplitude of excitation pulses. Although continuous duty cycle operation is possible, the LEF is most suitable for low intensity applications. In normal and high brightness cases, pulse drive is recommended, since continuous excitation decreases life.

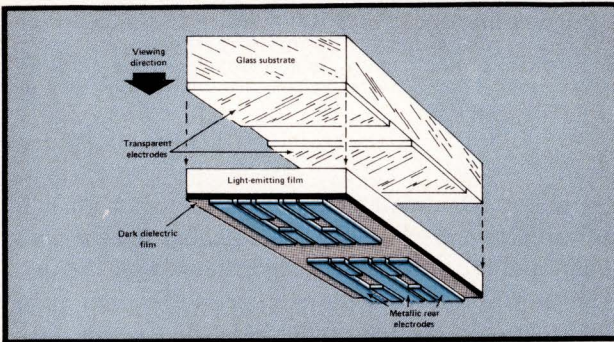

Light-emitting film cross-section. A phosphor thin film is synthesized on a double-strength window-pane substrate that is pre-coated with transparent electrodes. A light absorbing dielectric layer behind ambient illumination provides a high contrast dark background for the yellow-orange (5800 Å peak) display.

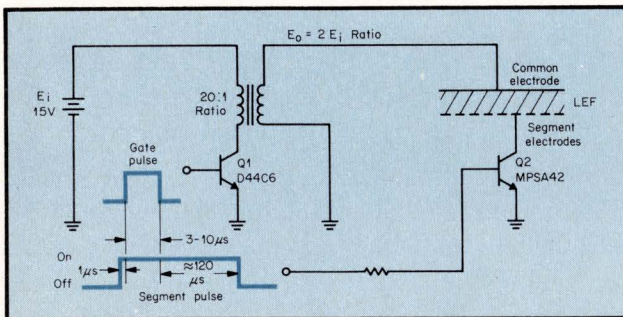

Pulse drive circuit. Pulsing transistor Q1 on stores energy in the magnetic field of the inexpensive pulse transformer. Turning Q1 off causes the field to collapse, inducing ringing in the reactive circuit of the secondary. A suitable turns ratio converts any dc source voltage to a useful output pulse. Grounding Q2 selects a display segment. Transistor Q2 should have a breakdown voltage of one-half to one-third the excitation voltage, and should turn on slightly before Q1 ($1\ \mu\text{s}$). This avoids the possibility of turning on at the peak of the induced voltage oscillation, when dI/dt is maximum. Q2 should turn off after about four cycles.

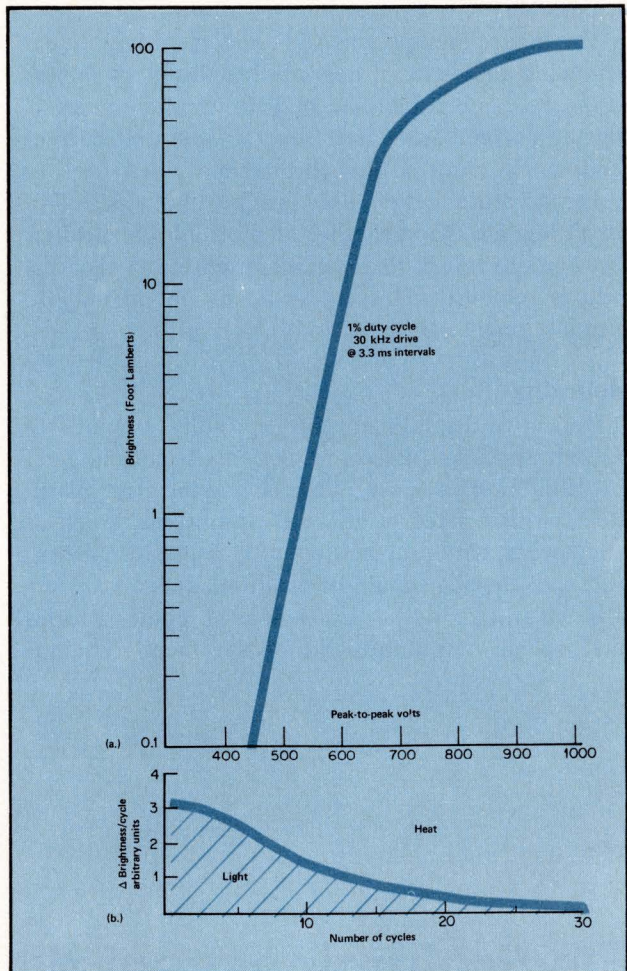

Brightness-voltage characteristic. Unlike bulk phosphor displays, brightness is very voltage sensitive below saturation. At 50 ft-L, a 10% voltage change changes brightness by a factor of four (a). Operating slightly above the bend, at 650 V pk-pk, with a reduced duty cycle, gives good efficiency and safe voltage margins. The preferred waveform is a burst of one to four sinewave cycles at 30 kHz, repeated at one millisecond intervals. Beyond that (b), the proportion of energy converted to light decreases in favor of thermal dissipation, which could damage the panel.

Where are we today?

In order to determine just where the display technology is at present, we queried over 40 manufacturers. Their answers are tabulated in Table I. There are a few cases of blatant irresponsibility, such as the two light-emitting diode manufacturers reporting that LED life is infinite, even though they are known to degrade with time. Many LED vendors also do not consider a bond or package failure a display failure. Unfortunately for these manufacturers, users disagree. Gas discharge vendors could make a better case for infinite life on grounds that there has never been a gas failure; it's always the cathode or the glass or something else. Fortunately, they have better sense.

A summary of Lloyd Taylor's remarks at the June symposium of the Society for Information Display (SID) is given in Table III. As president of Optimized Technology, Inc., Santa Clara, Calif., he currently ships 25,000 calculators a month that retail for below \$100, and he buys 3 million displays a year. His ranking bears out the general trend shown at lower volume in the data we were able to collect.

(continued on next page)

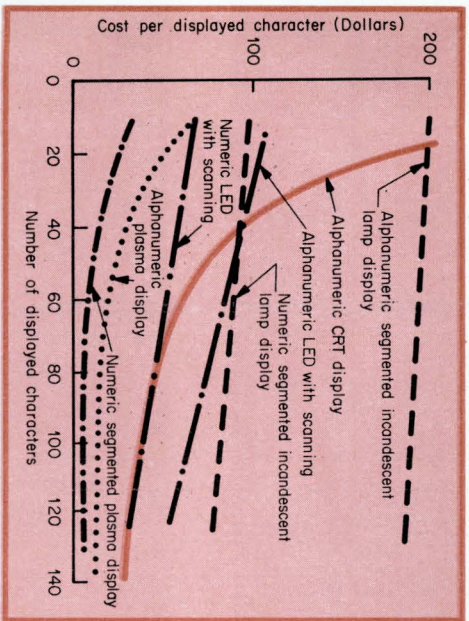

Cost comparison of display technologies applicable to airborne displays.

This table represents data collected from over 40 display manufacturers. The lowest and highest values for each parameter are listed. For example, all manufacturers of gas discharge numeric displays spec lifetime at between 10,000 and 20,000 hours.

Table I DISPLAY TECHNOLOGY - THE STATE OF THE ART

	No. of digits/module	Cost of A of display only (digit/(\$))	Cost of decoder/driver (digit/(\$))	Total cost A of integrated display (digit/(\$))	Character height (in)	Character style	Color(s)	Maximum viewing distance (ft)		Maximum viewing angle (degrees)	Display voltage B (volts)	Figure 8 power C (watts)	No. of digits which can be multiplexed	Life (Hours x 10 ⁵)
								Indoor	Outdoor					
NUMERICS														
Gas discharge	1-32	1.48- 3.75	0.42 ⁵ -1.50	2.02- 5.83	0.2-0.55	7-S, FF	Neon orange	15-40	8-20	60-65	160-250	0.005-0.562	10-16	1-2
Incandescent														
Directly viewed	1-20	1.95-11.00	1.00-5.75	2.95-16.75	0.38-0.71	7-S	Any	20-35	5-32	50-70	2.5-5	0.2-0.755	8-16	0.5-2.5
Back lighted	1-9	4.50 ¹ -19.00	4.50-11.00	10.00-26.00	0.32-3.00	7-S	Any	10-85	10-40	60-85	2.5-28	0.72-0.9	None-all	0.05-1
Rear projection	1-1	14.40-76.00	No data	No data	0.38-3.38	FF	Any	No data	No data	No data	5-28	No data	No data	No data
Vacuum fluorescent	1-13	1.35- 2.77	1.50-2.00	4.25-4.55	0.18-0.57	7-S	Green plus some filters	8-40	5-8	60-75	20-50	0.07-0.172	8-16	0.1-1.5
Cathode ray tube	1 ^D	22.50	No data	No data	0.62 ^D	FF	Green, red, blue	No data	No data	No data	Special ^D	No data	No data	No data
Light emitting diode	1-6	2.95-18.75	0.35 ⁵ -10.00	3.78-27.50	0.1-0.77	7-S, DM	Red, green, yellow	3.3-49	4-40	45-90	1.6-5	0.048-1.25	2-100	1-infinite
Liquid crystal	3-8	2.00- 5.00	1.43-9.12	6.27-12.10 ⁴	0.18-0.65	7-S	White or filtered	8-30	8-30	70	12-60	> 0.001-0.001	0-4	0.1-
Electroluminescent	9-21	1.05- 2.10	No data	No data	0.25-0.45	7-S	Yellow-orange	15-25	5-10	80	650	0.096-0.15	50	0.25
ALPHANUMERICS														
Gas discharge	16-80	3.91 ¹ -11.00 ¹	No data	3.91 ¹	0.2-0.4	DM	Neon orange	No data	No data	No data	200-250	0.278-0.8	16-80	No data
Incandescent														
Directly viewed	1-1	8.10-22.00	45.00-	56.40-67.00	0.31-0.62	16-S	Any	15-25	3-21	50-60	5	0.28-0.63	12	1-2.5
Back lighted	1-any	23.00-32.00	No data	32.00	0.32-0.75	16-S	Any	10-15	10-15	75	4.5-5	0.72-4.8	None-all	0.05-1
Rear projection	1 ^D	91.57	No data	No data	0.45 ^D	FF	Any	No data	No data	No data	5 ^D	No data	No data	No data
Cathode ray tube	1 ^D	55.00	No data	No data	0.62 ^D	FF	Green	No data	No data	No data	Special ^D	No data	No data	No data
Light emitting diode	1-5	10.00-39.00	11.50 ⁵	21.50-39.00	0.27-0.35	DM	Red	9.2-26	8	60-75	1.2-12	0.084-2.55	10-any #	1-10
Electroluminescent	9 ^D	4.00	No data ⁶	No data	0.45 ^D	13-S	Yellow-orange	20	7	80	650	0.144	50	0.25

A 1,000 quantity, unless otherwise specified.

B Some displays require several voltages. Voltage listed is for light emitting portion.

D Only one display reported.

E 7-S, 7 segments; FF, fully formed; DM, dot matrix; 16-S, 16 segments; 13-S, 13 segments.

1. 100 quantity

2. 100-999 quantity

3. 1-24 quantity

4. Combined cost of 2&3.

5. Some displays include cost of decoder-drivers.

6. No standard IC. Must be made from discretes.



Another user speaks

What is the cost per digit as a function of the number of digits displayed? That is a good question that was surveyed by D. R. Strandt of the Delco Electronics Division of General Motors for an Airborne Alphanumeric Control and Display Unit (CDU).* The Delco search was for an 18-character, high-brightness, alphanumeric display in a high reliability,

*E. R. Strandt, "Design of a Low Cost, Compact, Versatile Airborne, Plasma Alphanumeric Control and Display Unit." 1972 SID International Symposium Digest of Technical Papers, Vol. III, pp. 42-43.

non-calculator type of application. The results of his study are shown in the graph. His calculations include the cost of (1) the display, (2) its electronic components, (3) circuit card fabrication, assembly, and test, (4) interconnection and packaging, (5) contrast enhancement filter, and (6) power supply requirements. This is an excellent list of what must be considered when pricing the display subsystem. Items (3) through (6) must be included and are not trivial.

**Table II
DISPLAY MANUFACTURERS BY TECHNOLOGY**

Company*	Gas discharge	Hot filament	Back-Lit	Rear projection	Vac. fluorescent	CRT	LED	Liquid crystal	Electroluminescent	Reader Service No.	Company*	Gas discharge	Hot filament	Back-Lit	Rear projection	Vac. fluorescent	CRT	LED	Liquid crystal	Electroluminescent	Reader Service No.	
Alco	X		X							201	Major Data				X							222
Am. Micro-Systems								X		202	Master Specialties			X								223
Amperex	X									203	Monsanto								X			224
Bowmar							X			204	Motorola								X			225
Burroughs	X									205	National Electronics	X										226
Chicago Miniature		X					X			206	NRMEC									X		227
Diametrics		X								207	Opcoa								X			228
Dialight	X	X					X			208	Optel									X		229
Discon			X							209	Penn Keystone			X								230
Display General				X						210	Pinlites		X									231
Electrons			X							211	Raytheon	X										232
Fairchild MOD							X			212	RCA		X									233
Ferranti Electric							X			213	Readouts	X	X									234
General Electric					X		X			214	Shelly	X	X	X								235
Hewlett-Packard							X			215	Sperry	X										236
IEE		X	X		X		X			216	Sigmatron										X	237
Ilixco								X		217	Signalite	X										238
Info-Lite			X							218	Texas Instruments								X			239
Legi				X						219	Tronix								X			240
Litronix							X			220	Tung-Sol			X	X							241
Luminetics		X								221												

**Table III
HIGH VOLUME COST PER DIGIT FOR CALCULATOR DISPLAYS**

Technology	Display	Decoder-Driver	Total	Comments
Cold cathode	\$0.90	50-60¢	\$1.40-1.50	Lowest cost display today
Vacuum fluorescent	1.00	40-45¢	1.40-1.45	Must be sorted by brightness. Blanked digits stay brighter later in life
Hot filament	1.50-2.00	50¢	2.00-2.50	
LED	1.75-1.85	35¢	2.10-2.20	Must be graded for brightness.
Liquid crystal	Not available.			
Electroluminescent	Maximum life obtained is 3,000 hours. Not acceptable.			

COURSE: Packaging with ICs

Part 6

Automatic tests must be run by computer

Tom Healey,
Instrumentation Engineering, Inc.
Franklin Lakes, N.J.

No form of manual testing can begin to satisfy today's testing requirements for printed wiring boards, let alone backplanes, with their intricate wiring patterns. Thus, automatic testing of electronic circuit boards, sub-assemblies and systems has all but replaced manual testing as a vital production and quality assurance tool.

The main advantage of automatic testing is *cost savings*, because, when compared with manual testing

- It requires a lower level of technical skills from an operator;
- increases "throughput" per dollar invested;
- improves product quality assurance through more thorough and standardized tests;
- can decrease testing time up to 30 times;
- reduces not only direct-labor costs, but also the capital investment required to establish service repair facilities.

Automatic testing is particularly important for printed circuit boards, subassemblies and systems. As a matter of fact, it's easy to show the dramatic effect increased complexity has in causing failures of these boards. If a manufacturer produces boards holding 50 integrated circuits and 2% of his incoming ICs are faulty, then *63.6% of his boards will fail final test* (without including problems caused by incorrect component placement, wiring errors, soldering errors, etc.).

Board failure, therefore, is principally a function of complexity (particularly the number of ICs) and of the failure rate of the individual components. The table below indicates the probability of failure under several different conditions. Interestingly, if ICs have only a 1% failure rate on a board containing fifty of them, 39.5% of these boards will fail initial test. Actual experience in industry is frequently worse.

PROBABILITY OF INITIAL BOARD FAILURE

IC failure rate	ICs per board		
	30	50	100
1%	25.9%	39.5%	63.3%
2%	45.4%	63.6%	86.8%
5%	78.6%	92.3%	99.4%

The solution is obviously to *identify* failures and *isolate* them, in order to repair inexpensively. Testing costs vary, depending on the number of units tested. The graph below, from a study by Texas Instruments, indicates that for most board lot sizes, it is more economical to use computerized (stored program) test systems. (*Course continues on p. 48*)

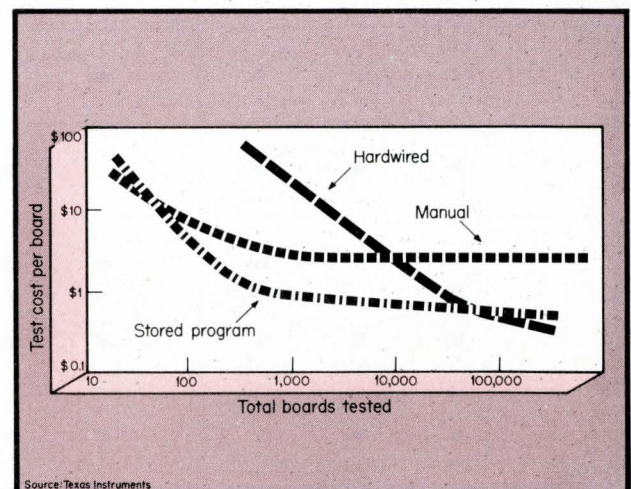

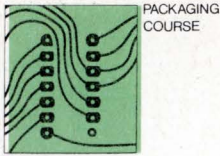

PART 6

Testing backplane wiring

Contributed by Teradyne, Inc.
Boston, Mass.

Backplane testing, or, for that matter, the testing of any complex interconnection scheme, can be reduced to the general problem of testing a network of n nodes. The number of possible point-to-point interconnections in such a network is

$$\frac{n!}{2!(n-2)!}$$

Even a small backplane can have more than 1000 nodes. The number of possible interconnections, therefore, builds up very rapidly and requires a computer to test them.

Before testing, however, the computer must "learn" the correct interconnection scheme. While any computer can accept this information from input commands, a much more efficient method is to learn it by testing a properly wired panel. The Teradyne N131 works on this principle. It "studies" the interconnection scheme in an unknown network by applying stimuli to all pins in sequence while simultaneously monitoring the entire network to establish continuity paths. Typically, this network mapping takes less than half a minute for a 2000-pin network.

In practice, the above mapping is conducted on a backplane or network known to be good. The computer stores it in its memory, and manipulates it from then on as data. To read the list of connections, the user can ask the system to print out a "run list" of the interconnection scheme stored in its memory. This list identifies the networks as the system has learned them, and is thus very useful when diagnosing failures. To map a network, the computer subdivides the entire assembly under test into families and groups defined by the user, with each pin identified by a

family name, group number, and a pin number. A network is defined by the system in terms of all the pins that share a common continuity path. For example, the following output statement (from the run list) means that Network 1 interconnects pins 1 in groups 1, 2, 2, & 4 of Family A, groups 1, 2, & 4 of Family B, and groups 1, 2, & 3 of Family C.

FAMILY-GROUP-POINT

```
A-01-01 A-02-01 A-03-01 A-04-01 B-01-01
B-03-01 B-04-01 C-01-01 C-02-01 C-03-01
```

A group is a continuous number of points (or pins) and a family is a sequential number of groups having something in common. The numbers or letters assigned to these points, groups, and families may be arbitrarily chosen by the user of the system.

When testing an unknown network, the N131 will discover any unintended open or short circuit involving any pin, whether that pin is normally used or unused, and it will print out an error message in plain English precisely locating the fault. The figure below shows some of the many types of wiring errors that are detected, along with the corresponding error messages. Note that, in the fourth test (after Network 4), two unused pins were found incorrectly connected together. When the system detects such a fault, the diagnostic statement describes it as the formation of a new network. (The word NET 9 in the example assumes that eight networks have already been assigned.) Such error messages, used in conjunction with the run list, enable the operator to pin-point the wiring defect quickly.

CORRECT	ACTUAL	ERROR MESSAGE
<p>NET 1</p> <p>A-1-01 A-1-02 A-1-03</p>		<p>UNUSED POINT A-1-03 SHORTED TO NET 1</p>
<p>NET 2</p> <p>A-1-01 A-1-02 A-1-03</p>		<p>POINT A-1-03 OPENED FROM NET 2</p>
<p>NET 3</p> <p>A-2-01 A-2-02 A-2-03</p>		<p>POINT B-2-06 FROM NET 4 SHORTED TO NET 3</p>
<p>NET 4</p> <p>B-2-04 B-2-05 B-2-06</p>		<p>UNUSED POINT C-3-01 PART OF NEW NET 9 UNUSED POINT C-3-02 PART OF NEW NET 9</p>
<p>C-3-01 C-3-02 C-3-03</p>		

Announcing a reliable way to come in under budget.

Our new commercial Series 8 miniature manual switches provide quality construction and reliable performance at a low cost.

The positive detent action is a good example of our quality construction. It assures you of excellent tactile feedback.

For safer operation, there's maximum separation between the terminals and the metal mounting and operating elements. And our case, using superior arc-resistant materials, has excellent compartmentation to isolate individual internal circuits.

There's a choice of toggles (select from lever styles and colored, slip-on caps), paddles and rockers (snap-in mounting and choice of colored buttons), and lighted rockers. Also select from pushbuttons with colored buttons in two sizes.

All this makes the Series 8 perfect for jobs where money and space are limited, but performance standards aren't. Communications equipment, test and measuring devices, computer peripheral and business equipment are examples. Series 8 switches are rated 6 amps, 125 VAC.

For additional information, see your MICRO SWITCH Branch Office or Authorized Distributor (Yellow Pages, "Switches, Electric"). Or write for our Series 8 Product Brochure.

MICRO SWITCH makes your ideas work.

MICRO SWITCH

FREEPORT, ILLINOIS 61032
A DIVISION OF HONEYWELL



...SIMPLIFIES POWER SUPPLY REQUIREMENTS

A Simple McMOS System Power Supply

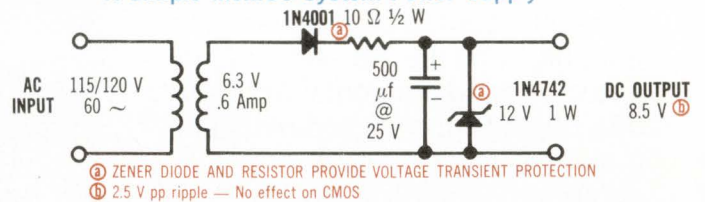

EXPANDING McMOS FAMILY

Motorola Device #	Function	Replaces Pin-for-Pin	New Low Price (100-999)
MC14001AL/CL	Quad 2-input NOR Gate	CD4001AD/AE	3.40/ .78
MC14002AL/CL	Dual 4-input NOR Gate	CD4002AD/AE	3.40/ .78
MC14011AL/CL	Quad 2-input NAND Gate	CD4011AD/AE	3.40/ .78
MC14012AL/CL	Dual 4-input NAND Gate	CD4012AD/AE	3.40/ .78
MC14013AL/CL	Dual Type D Flip-Flop	CD4013AD/AE	4.75/ 1.62
MC14015AL/CL	Dual 4-bit static SR, serial in/parallel out	CD4015AD/AE	10.15/ 4.24
MC14021AL/CL	8-bit static SR, serial or parallel in/serial out	CD4021AD/AE	9.75/ 4.24
MC14025AL/CL	Triple 3 NOR Gate	CD4025AD/AE	3.40/ .78
MC14027AL/CL	Dual J-K Flip-Flop	CD4027AD/AE	5.25/ 2.50
MC14501AL/CL	Triple Gate	—	4.30/ 1.69
MC14507AL/CL	Quad exclusive OR Gate	CD4030AD/AE	3.79/ 1.63
MC14508AL/CL	Dual 4-bit Latch	—	24.70/ 13.75
MC14510AL/CL	BCD Up/Down Counter	—	11.47/ 6.35
MC14512AL/CL	8-channel Data Select	—	7.20/ 4.00
MC14514AL/CL	4-bit Latch/4-to-16 Line Decoder (Hi)	—	24.70/ 13.75
MC14515AL/CL	4-bit Latch/4-to-16 Line Decoder (Low)	—	24.70/ 13.75
MC14518AL/CL	Dual BCD Up Counter	—	12.90/ 7.20
MC14519AL/CL	4-bit AND/OR Select, Quad excl NOR Gate	—	4.75/ 1.91
MC14520AL/CL	Dual Binary Up Counter	—	11.47/ 6.35
MCM14505AL/CL	64-bit RAM	—	31.30/ 17.50
> Recent Introductions <			
MC14007AL/CL	Dual Pair and Inverter	CD4007AD/AE	2.65/ .78
MC14009AL/CL	Hex Inverter/Buffer	CD4009AD/AE	5.25/ 1.69
MC14010AL/CL	Hex Inverter	CD4010AD/AE	5.25/ 1.69
MC14023AL/CL	Triple 3 NAND Gate	CD4023AD/AE	3.40/ .78
MC14040AL/CL	12 Stage Binary Counter	CD4040AD/AE	10.20/ 5.40
MC14506AL/CL	Expandable A.O.I.	—	4.64/ 2.24
MC14516AL/CL	Binary Up/Down Counter	—	11.47/ 6.35
MC14522AL/CL	Programmable BCD	—	11.85/ 6.60
MC14526AL/CL	Divide-by-N 4-bit Counter	—	11.85/ 6.60
MC14527AL/CL	Programmable Binary	—	11.85/ 6.60
MC14527AL/CL	Divide-by-N 4-bit Counter	—	11.85/ 6.60
MC14527AL/CL	BCD Rate Multiplier	—	11.85/ 6.60
> August and September Introductions <			
MC14000AL/CL	Dual 3-Input NOR plus Inverter	CD4000AD/AE	3.10/ .78
MC14006AL/CL	18-bit Shift Register	CD4006AD/AE	9.10/ 3.89
MC14008AL/CL	4-bit Full Adder	CD4008AD/AE	10.15/ 4.02
MC14016AL/CL	Quad Analog Switch/Quad Multiplexer	CD4016AD/AE	5.15/ 1.62
MC14028AL/CL	BCD Decimal Decoder	CD4028AD/AE	7.92/ 3.67
MC14032AL/CL	Triple Full Adder (pos)	CD4032AD/AE	6.91/ 4.24
MC14038AL/CL	Triple Full Adder (neg)	CD4038AD/AE	6.91/ 4.24

*TRADEMARK OF MOTOROLA INC.

Time was, when power supply requirements were significant design and cost considerations in logic systems. Complementary MOS has changed all that.

This simple, inexpensive[†] supply can power a 10,000 gate or equivalent McMOS* system at 100 kHz, provide voltage transient protection, and work from ac line voltage as low as 100 V. Only CMOS has the combination of low power dissipation and wide supply voltage range to carry that off. No other logic form even comes close.

Time was, too, when there was only one major CMOS source with enough functions for complete system design, and some of those devices looked more like custom parts thrown into the standard bin to build up a list. McMOS has changed all that.

McMOS is the CMOS family that second sources popular existing system-oriented types, with improvements. McMOS also develops and introduces imaginative original circuits where the best of what's already available doesn't meet system needs. This balanced approach to CMOS family planning has produced a line of thirty device types stocked and available by mid-year where there were only seven at the start of 1972. Additional types are far enough along to insure a complement of more than 45 system-oriented devices by year's end, with all available in both AL Series (power supply range 3 V to 18 V and $T_A = -55^\circ$ to $+125^\circ\text{C}$) and CL Series (3 V to 18 V and -40° to $+85^\circ\text{C}$).

McMOS has new low prices, too.

This is the year of McMOS . . . the low-power logic of the seventies. The brochure, McMOS '72 tells lots more about McMOS. Get one simply by circling the reader service number or by writing to Motorola Semiconductor Products Inc., P. O. Box 20912, Phoenix, Az. 85036. Bonus! — while it lasts — special McMOS wall chart poster with interface diagrams.

[†]Total component cost < \$3.75, low 100-up quantities, June price lists.

 **MOTOROLA MOS**
Directions in digital designs

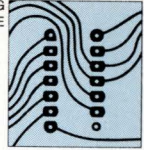

Test your IQ about packaging with ICs

We hope you have profited from this course on "Packaging with integrated circuits." Now is the time to show how much you have, by applying your knowledge to the multiple-choice questions below. The quiz is open-book. You can go back, read, and reread the chapters. After all, the purpose of this exam is not to save on completion certificates, but to increase your proficiency in packaging.

Please enclose \$1.00 to cover the costs of handling and grading your exam, and printing the certificate. Mail to:

Packaging Test
The Electronic Engineer
Chilton Company
One Decker Square
Bala Cynwyd, Pa. 19004

1. Dual-in-line packages are used (a) exclusively for semiconductor ICs; (b) exclusively for semiconductor ICs and hybrid ICs; (c) for semiconductor ICs, hybrid ICs, and passive components such as resistor networks; (d) for semiconductor ICs, hybrid ICs, passive components, relays, and switches.
 - a.
 - b.
 - c.
 - d.

2. In simple layouts using few ICs, which IC package provides the highest density at the printed-wiring board? (a) the TO-package because it's round, and its leads go through the board; (b) the flatpack because it's square, smaller, and its leads lie flat on the board; (c) the dual-in-line, because it's mounted above the board, and therefore allows crossovers.
 - a.
 - b.
 - c.

3. In complex layouts using dozens of ICs, which IC package provides the highest density at the printed-wiring board? (a) the TO-package because it's round, and its leads go through the board; (b) the flatpack because it's square, smaller, and its leads lie flat on the board; (c) the dual-in-line, because it's mounted above the board, and therefore allows crossovers.
 - a.
 - b.
 - c.

4. Which type of encapsulation is more economical for mass production of IC packages? (a) plastic; (b) hermetic brazing; (c) epoxy; (d) TO-size metallic can.
 - a.
 - b.
 - c.
 - d.

5. It is cheaper to mount a dual-in-line-packaged network of resistors than an equivalent number of discrete resistors (a) for any quantity, because the cost per resistor is lower for DIPs; (b) above a certain quantity, because the cost per DIP-packaged resistor is higher, but the cost of insertion for DIPs is about the same or slightly lower than for a discrete resistor; (c) below a certain quantity, because the cost per DIP-packaged resistor is lower, but the cost of insertion for DIPs is much higher; (d) because the cost per resistor is the same, but the cost of insertion is much lower for DIPs.
 - a.
 - b.
 - c.
 - d.

6. Automatic insertion of components is economical (a) only when inserting tens of thousands of components in identical PW boards; (b) for short runs, to aid the operator in finding the location of components; (c) both of the above; (d) for runs from 500 to 1000 identical printed-wiring boards.
 - a.
 - b.
 - c.
 - d.

7. If we include the time spent for rework in hand assembly of printed-wiring boards, (a) computer-controlled automatic insertion can speed up assembly by a factor of 30 to 40:1; (b) a pantograph can speed up assembly by a factor of 30 to 40:1; (c) neither of the above.
 - a.
 - b.
 - c.

8. Single-sided printed-wiring boards are more popular in (a) electronic countermeasures equipment; (b) radio and TV sets; (c) large central processors for high speed computers; (d) minicomputers.
 - a.
 - b.
 - c.
 - d.

EXAM

9. Printed-and-etched circuit boards suffer from the following reliability problem: (a) The etchant is too strong, and usually attacks the copper conductors through pinholes in the photoresist; (b) traces of positive resist remain after the washing cycle, and prevent the copper conductors from tinning when dipped in solder; (c) the etchant is too light, and usually leaves copper filaments on the board which short circuit other conductors; (d) solder slivers, which may produce shorts, form in those places where the etchant undercuts the edge of copper conductors.
10. Compared with double-sided pw boards, the cost of multilayer boards in production quantities is (a) 10 to 15% higher per layer; (b) twice as high, regardless of the number of layers; (c) double for up to two layers plus 50% more for each additional layer; (d) lower, because of the savings in weight and area.
11. Flat conductor cables (FCC) yield major savings over a harness of round wires because (a) they are lighter; (b) they cost less, for the same cross section; (c) there's no need to make a harness; (d) the connectors for FCC cost less; (e) no savings.
12. When using 14-lead DIPS, an average density of two packages per square inch can be obtained with (a) single-sided printed-wiring boards; (b) double-sided boards; (c) multilayer boards; (d) pre-fabricated "socket" boards.
13. The main advantage of pin-in boards over socket-boards for ICs is (a) low profile; (b) cost; (c) more suitable for LSI packages; (d) accept not only DIPS, but also TO packages and flat packs; (e) more suitable for solderless wrapping.
14. For DIPS, the main advantage that insertion in sockets offers over direct soldering to the boards, is (a) flexibility to design changes; (b) cost, for any quantity; (c) cost, for quantities under 500 boards of one hundred 14-lead DIPS each; (d) cost, for quantities over 500 boards of one hundred 14-lead DIPS each; (e) low profile.
15. If you have to wire 100 panels with 250 wraps each in one week, and there is little time for rework and quality control, the most economical approach is to use (a) fully automatic machines; (b) semiautomatic machines; (c) hand wiring; (d) either hand wiring or semiautomatic machines, depending on the skill of your programmers and of your operators.
16. Which of these wraps is acceptable?

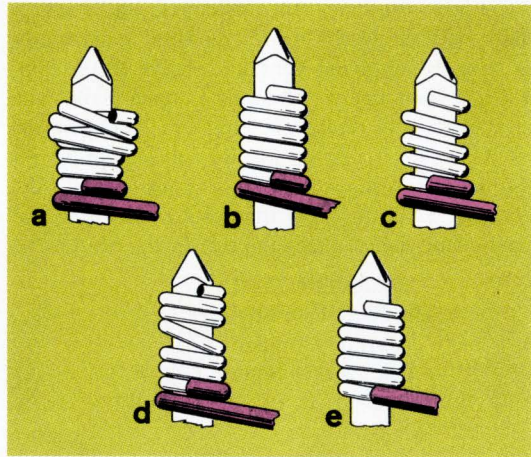

17. An advantage of Termini-Point® over Wire-Wrap® is that it (a) can be applied to both square or rectangular posts; (b) frees one of the wiring levels for modifications; (c) can handle solid and stranded wire; (d) is more reliable, according to Mil-Spec HBK-217.
18. The characteristic impedance of backplane interconnections, either soldered or solderless, can be estimated because they resemble (a) a system of single wires near a ground plane; (b) a parallel-wire system; (c) true coax; (d) strip-line.
19. When a single, *quiet* line, runs parallel to another single, *active* line, the signal in the active line (a) is not affected, because the reflection for both the even and odd modes of the signal cancel out; (b) goes down by the amount of back crosstalk; (c) increases by the amount of back crosstalk; (d) increases by the amount of forward crosstalk.

20. If the heat generated in an electronic package is less than 0.04 W/cm^2 of surface area at ambient pressure, it is sufficient to cool it with (a) natural cooling; (b) natural cooling plus metallic fins and radiators; (c) forced air; (d) Freon® pumped through the equipment; (e) heat pipes.

- a.
- b.
- c.
- d.
- e.

21. Integrated circuits mounted under the hood of an automobile can encounter temperatures (a) higher than the usual military top limit of 125C; (b) lower than the usual military low limit of -55C; (c) both; (d) neither.

- a.
- b.
- c.
- d.

22. To test 1000 identical printed-wiring boards which hold ICs, the most economical tester is (a) manual; (b) automatic, run by a stored-program computer; (c) automatic, hard-wired; (d) automatic, adaptive.

- a.
- b.
- c.
- d.

23. Suppose the Production Department is assembling a run of identical printed circuit boards, holding 70 ICs each. The IC failure rate is 1%/1000 hs. One day, Purchasing tells you another semiconductor manufacturer is quoting 10% less for the same ICs. You question what's their failure rate, and the answer is 2%. If you accept them, would the probability of initial board failure (a) increase by 20%; (b) increase from about 45% to about 67%; (c) increase from about 35% to about 56%; (d) increase from about 54% to about 78%; (e) increase from about 61% to about 70%?

- a.
- b.
- c.
- d.
- e.

Don't forget to fill in your name and address, and enclose \$1.00 to defray expenses.

Please send my certificate to:

Name: _____
 Company: _____ Title: _____
 Street: _____
 City: _____
 State: _____ Zip Code: _____

Packaging Course Reprint

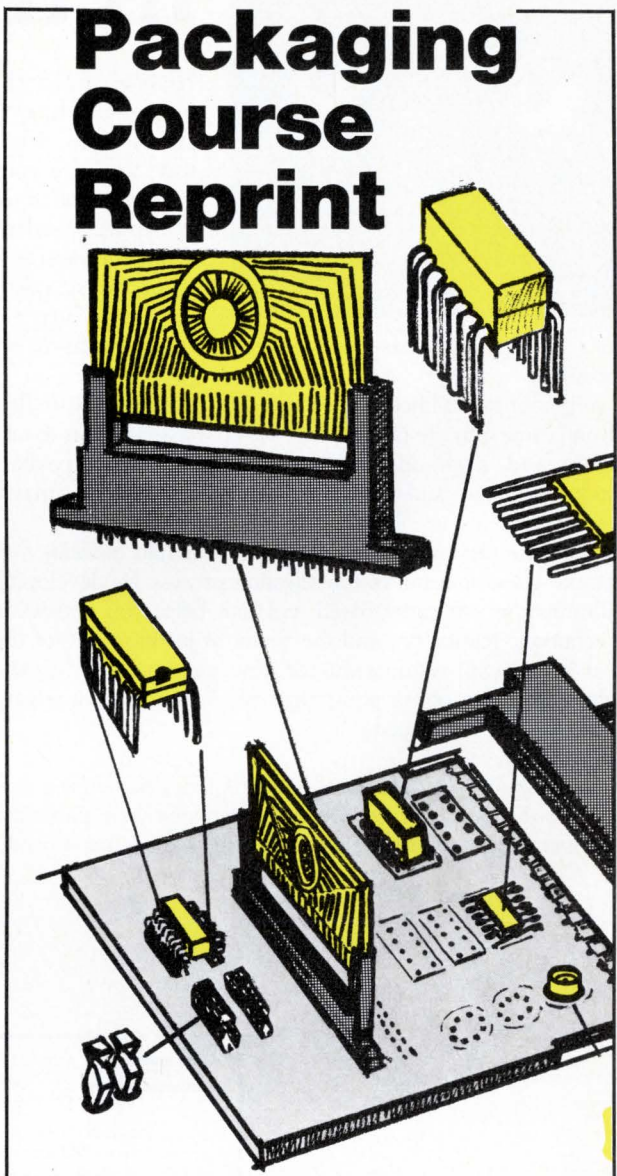

Upon its completion in *The Electronic Engineer*, the entire course on PACKAGING WITH ICs will be reprinted and bound with its own cover for permanent reference. A limited number of copies of the course will be available at \$6.00 each. In order to guarantee your copy and to aid us in planning, please fill out the coupon below. Send it today to **The Electronic Engineer**, One Decker Square, Bala-Cynwyd, Pa. 19004. Do not send your remittance now. We will notify you when your reserved copy is available.

Please reserve . . . copies of the PACKAGING COURSE at \$6.00 per copy.

Name _____
 Address _____
 Company _____
 City _____ State _____ Zip _____

All cats look the same in the dark.

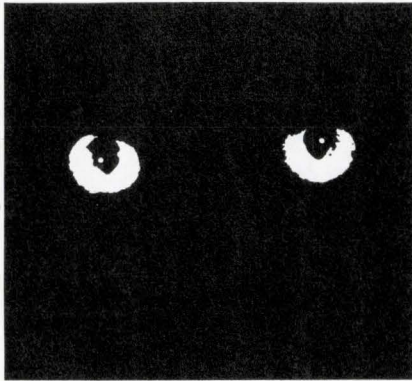

Heaven help the man who has to choose one, when the "cats" are computer automated test systems. Nailing down the most efficient, least costly system to suit the

plant's requirements has been expensive and tough—if not impossible.

Equipment capabilities, system speed, hardware/software flexibility all come into the picture. But the boardroom wants to take a hard-nosed, profit-oriented look at capital outlay, payback periods, overhead, and the impact of cost savings over current test methods.

At last one test system manufacturer, Fairchild Systems, has taken the guesswork out of the selection process. By developing an illuminating computer-based tool that helps you determine the economic feasibility—and the financial justification—of the pre-use testing of semiconductor devices. And matches the results to the level of our equipment you will find most advantageous for all concerned.

We call it SAVE.

System Analysis of Value Economics. A fancy name for a simplified mathematical procedure that simulates your particular plant operations over a wide range of testing situations—incom-

ing inspection, QA, PCB, wafer and final production testing.

SAVE consists of easy-to-fill-in forms, which take you step by step through all your applications, configurations, number of stations, even the number of daily work shifts. Types and quantities of devices used are considered, with your average rate of untested defectives balanced in.

Your completed forms are fed through Fairchild Systems' SAVE-programmed computer. To deliver hard data on total comparative costs for test equipment replacement, system costs, operating expenses, including payback period and actual net savings realized.

The SAVE read-out is also useful for evaluating alternative system configurations as they relate to the customer's operation, to provide cost-effective solutions. And because SAVE offers in-depth simulation of system test operations, a plant designer can also use this capability to maximize his software/hardware utilization, his operating policies, and to "fine tune" his system for optimum performance.

And finally, the computerized analysis helps you establish the most economical, most productive level of test equipment from our optimized Sentry series—the large-scale Fairchild Systems with unmatched speed, sophistication and flexibility. From MOS to bipolar, from IC's to discretes, or LSI—with software compatible to all, and the lowest throughput costs in the field—the Sentry family offers you total semiconductor testing capability with enormous expansion and adaptability options. And SAVE shows you how to make the most of it.

FAIRCHILD SYSTEMS TECHNOLOGY	Fairchild Systems 3500 Deer Creek Road Palo Alto, California 94302
<input type="checkbox"/>	Please send us your SAVE Economic Analysis Kit for semiconductor test systems.
<input type="checkbox"/>	with details on your modular testers.
<input type="checkbox"/>	with details on your Sentry Systems.
<input type="checkbox"/>	Call us immediately for individual application assistance.
Name _____	
Title _____	
Company _____	
Street _____	
City _____ State _____	
Zip _____ Telephone _____	

Fairchild Systems

Fairchild Systems Technology, a division of Fairchild Camera & Instrument Corporation.

AUGUST 1972

DATA COMMUNICATIONS



Does a minicomputer fit into your data communications plans? Before you answer, take a look at these applications' cautions and design alternatives.

Data communications news and products

**Our terminal capabilities outnumber
your problems.**

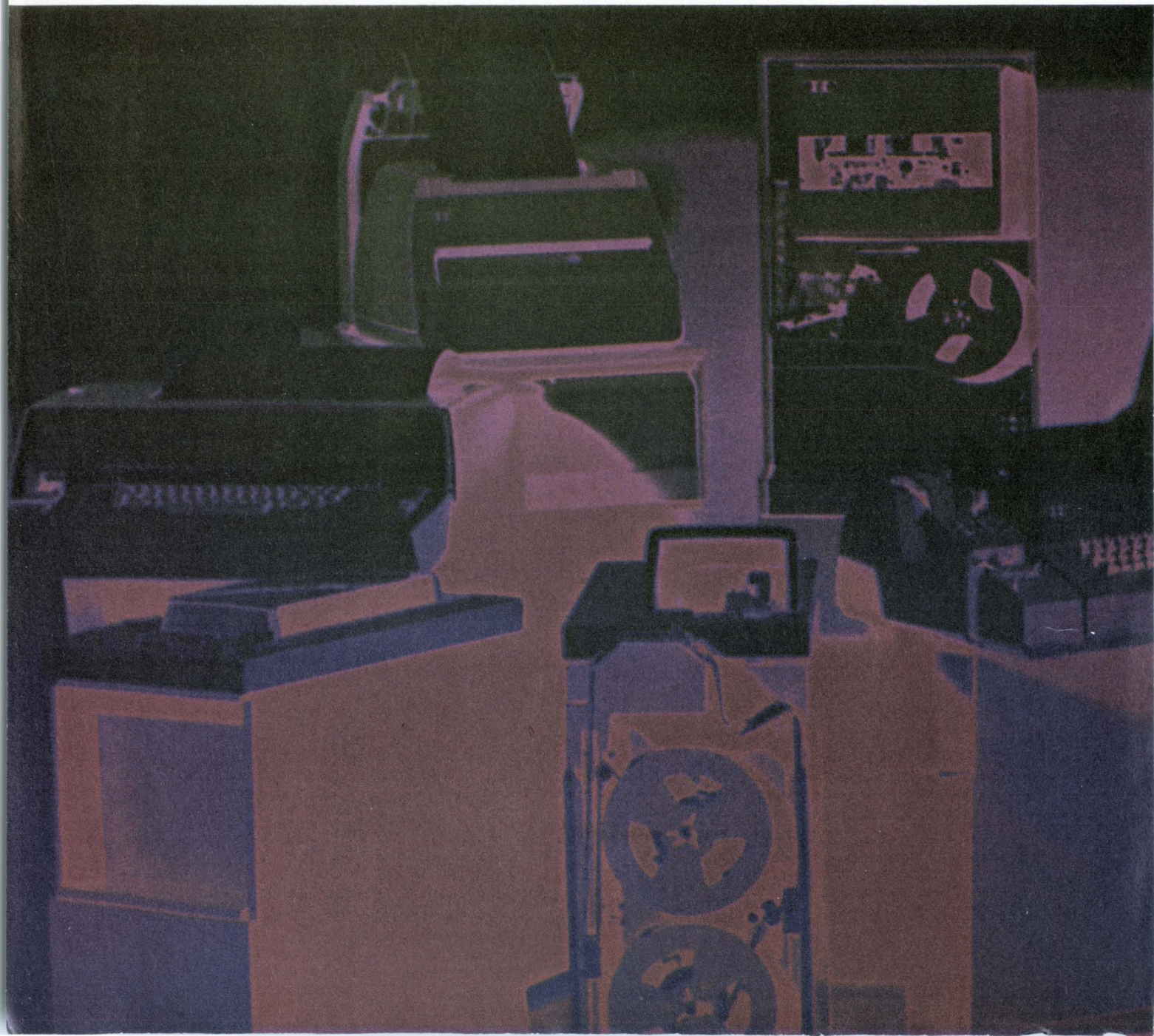

The answer to your remote-computing needs is probably right on this page.

Like our model 33. Economy and reliability have made it the most popular data terminal of its kind. Or like our new wide-platen model 38. We loaded it with big machine features but we left off the big machine price tag. For high-volume operations, our model 35 is built to run day and night, year in and year out. And if your system is highly complex, our model 37 delivers the utmost in flexibility and vocabulary.

To move information on-line at speeds up to 2400 wpm, all our keyboard terminals are compatible with the Teletype® 4210 mag tape data terminal. We also manufacture paper tape senders and receivers with speeds up to 2400 wpm.

To make sure you get what you need, we sell assembled ASR, KSR and RO terminals, as well as components—printers, keyboards, readers and punches.

You can also select from three different interface options: a built-in modem; a current interface; and an EIA Standard R-232-C interface.

Platen widths range all the way up to 15 inches.

Besides alphanumeric, we can give you Greek letters, algebraic and chemical symbols, as well as special graphics.

We also cover error detection and station control with a complete group of solid-state accessories.

And our machines never have to stand alone. Our applications engineers will work with you to make sure the terminal you buy from us is exactly what you need. And our maintenance

Circle Reader Service #23

people are ready to make sure things keep running smoothly.

So whatever data terminal problems you're up against, come to us for help. Because when it comes to flexibility, reliability and economy, you can't beat the machines that carry our name.

It takes more than manufacturing facilities to build the machines Teletype Corporation offers. It also takes commitment. From people who think service is as important as sales. In terminals for computers and point-to-point communications.

That's why we invented a new name for who we are and what we make. The computer-cations people.



For more information about any Teletype product, write or call **TERMINAL CENTRAL**: Teletype Corporation, Dept. 55C, 5555 Touhy Avenue, Skokie, Illinois 60076. Phone 312/982-2500

Teletype is a trademark registered in the United States Patent Office.



Still paying for oscillator stability you don't need?

Plug in our K1065A instead. Medium stability and price. 1 to 5 MHz range: 3×10^{-8} stability for -20° to $+55^{\circ}\text{C}$; less than 5×10^{-9} aging per day. Prototype quantities available for immediate delivery in 1.0 MHz and 5.0 MHz. Details available from Motorola Component Products Dept., 4545 W. Augusta Blvd., Chicago, Ill. 60651.  **MOTOROLA**

Can a mini solve your communications problem?

Knowing your application is only half the battle. You must also choose the best design option for a successful system.

Peter Goldstern

Digital Equipment Corp., Maynard, Mass.

Increasingly, minicomputers are being used in applications involving data communications. And since data communications systems promise to become even more important for even more varied uses than is presently the case, there is considerable interest in what a mini can do in data communications. For instance, how should you configure a system to perform data communication functions, and what problems are likely to crop up in configuring such a system?

What are the applications?

Perhaps the most encompassing phrase in data communications is "message processing," which actually includes a variety of related functions. The simplest of these functions is data concentrating. This action saves on line costs and hardware by combining a number of slow-speed lines into a single output that is transmitted over a high-speed line.

Allied to this, and in one way an extension of this idea, is that of data gathering. Here, a mini-computer contacts devices, stores the data on tape, and/or transmits this data to the applications computer. Not only software, but also the correct storage devices—magnetic tape or disk—are required for such a system to work efficiently.

Message switching is a step more sophisticated than either merely gathering or transmitting data. In this applications, the minicomputer acts as a "traffic cop" to identify the source of a message, its destination, and makes sure that the message reaches its destination, if possible. When the minicomputer receives an incoming message, it determines whether the message is addressed to a valid destination. If not, the mini must signal back that the addressed destination is incorrect. The case of the correctly addressed data is a little more complicated, depending upon the organization of the message switching system. If the data can be transmitted, there is no problem. If the circuits are busy, however, one of two processes can occur, depending upon the degree of sophistication of the minicomputer system used. In the simpler system, when the output circuit is occupied, the system merely informs the user that his signal did not go through (in this respect, equivalent to the "busy signal" of a telephone). The more sophisticated system transfers the data to a high-speed mass storage device, usually a magnetic disk. The minicomputer keeps trying the circuit until it is free and then "plays back" the data from the storage device. With dedicated communications lines there is no problem of connection to the computer or terminals. However, with dial lines (telephone, Telex, or TWX), the system must respond to incoming calls by answering, and it must be able to "dial out" to make connection to its destination.

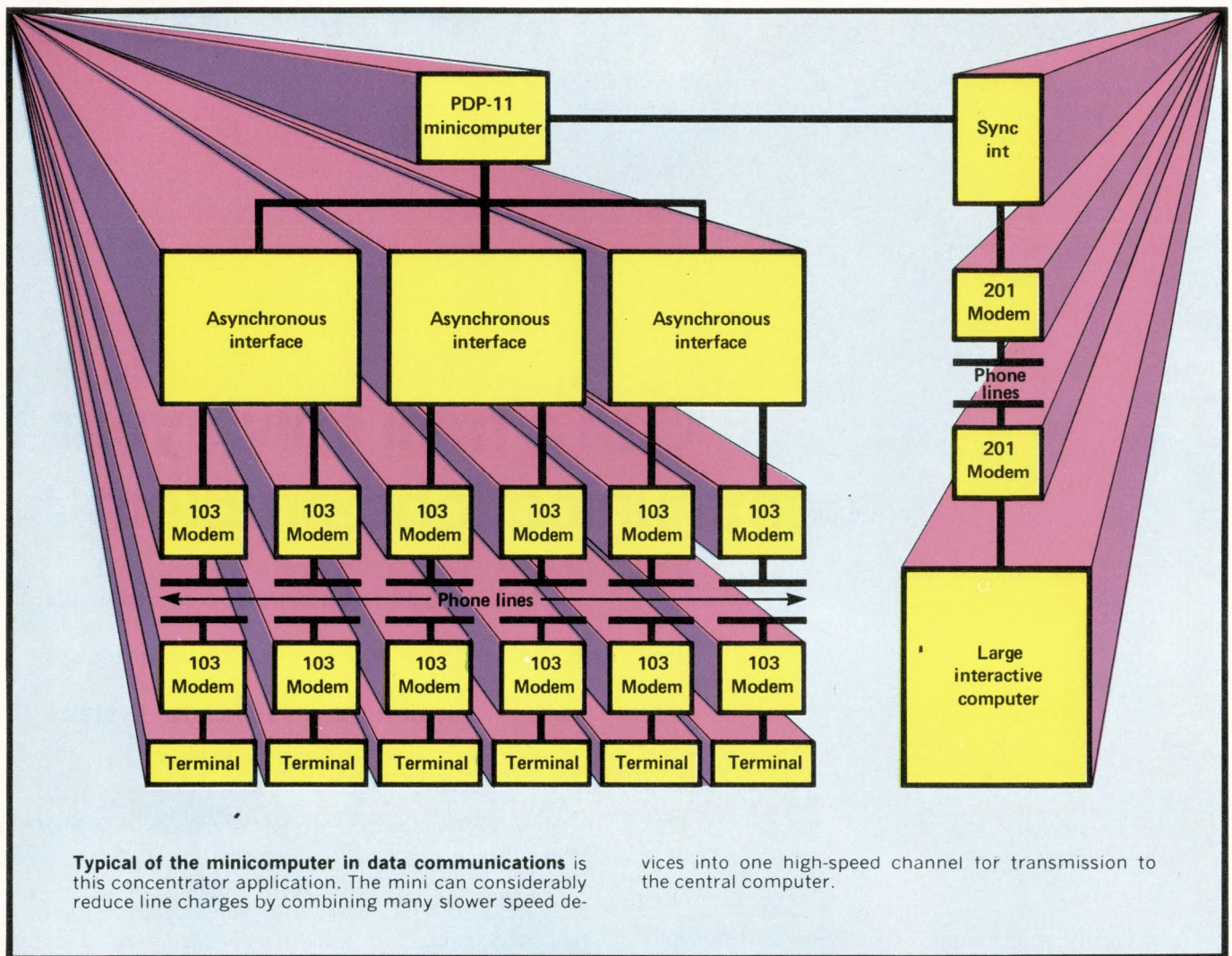

Another form of message processing is termed "front-end processing." In this mode, the minicomputer not only acts as a traffic controller, it also does some of the work usually performed by the application computers. For example, the front-end processor may convert many different codes to one uniform code so that the application computer does not have to store the conversion programs itself. This frees more of the application computer's internal storage for processing, thus making it effectively a more powerful machine.

Implementing the system

One solution to the problem of choosing the correct mini for a communications function is to buy a complete "package" from a manufacturer. In some cases, both computer manufacturers and communication equipment manufacturers market complete systems to perform data communications functions. These "turn-key" packages have the marked advantage that the manufacturer guarantees the whole operation, including both hardware and software, will work as a system. Planning such a system becomes

merely a matter of looking at the whole system as a "black box" and worrying about only with what goes in and comes out. With this approach, the manufacturer will support (that is, provide service for) the system as a system. On the other hand, a minicomputer manufacturer, for example, cannot support a system configured by somebody else without charging an exorbitant rate—if he will do it at all.

A second, and allied, approach is to get a manufacturer to "custom design" a system. While such a system would not be as inexpensive as a standard system—the manufacturer still would be able to do all the appropriate interfacing from standard parts. Further, the manufacturer could develop the software more easily because of his familiarity with his computers. And finally, he would still support the system as a system.

A third approach is to contract an outside firm (systems house) to develop a whole turn-key system. Unlike a manufacturer, a systems house is not locked in on particular hardware and thus can select with less prejudice. But a systems house will have to develop the system from scratch, including all docu-

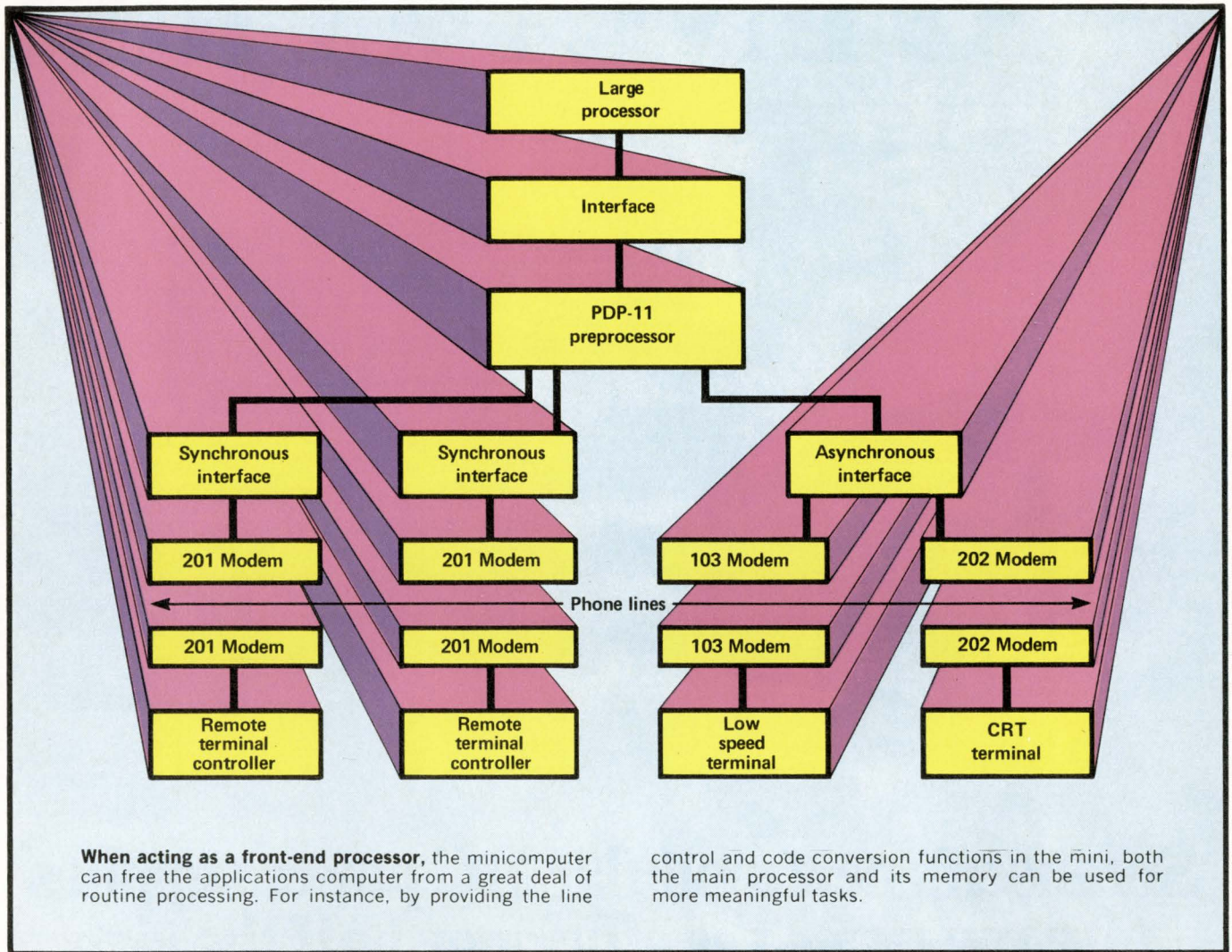

mentation, support material, and diagnostic programs. The systems house (or the user) would also have to take responsibility for maintenance of the system. Replacement parts, which may be more difficult to come by, will usually cost more.

Another approach is for the potential user to buy the hardware and contract with a programming firm to develop the required programs. Here, the user is committing himself to the support of the system; and the software house is obliged only to deliver programs that will just meet the contracted specifications. Such software might not allow room for expansion, should the demands on the system require it.

A new technique is that of the user "rolling his own" system. This recent development grew out of the introduction of the modular approach to minicomputer communication equipment. Here, some standard minicomputer configurations, both software and hardware permit the user to build up his own system. With the proper software packages, the user can take a minicomputer and have a foundation that he can "fine tune" to his particular problem.

And the manufacturer will support the computer and the basic software package, forming an element of systems support that was previously lacking.

Before a potential user commits himself to a data communications system, he should ask himself the following:

- Will the system remain in its present form, or is it likely to require expansion?
- Who will do the actual maintenance on the system?
- If I build the system myself, will total knowledge of the system's components and operations be available? If not, am I creating an "indispensable" position?
- If I have an outside concern build it, what kind of backup support will I require? Where will I get it?
- In choosing the computer, are other mini's being used for similar applications? Or if none are, are any being used in related applications?

These questions, plus the guidelines discussed previously, will go far in helping any potential user determine how he can approach the problem of using minicomputer data communication systems.

STM. Not just

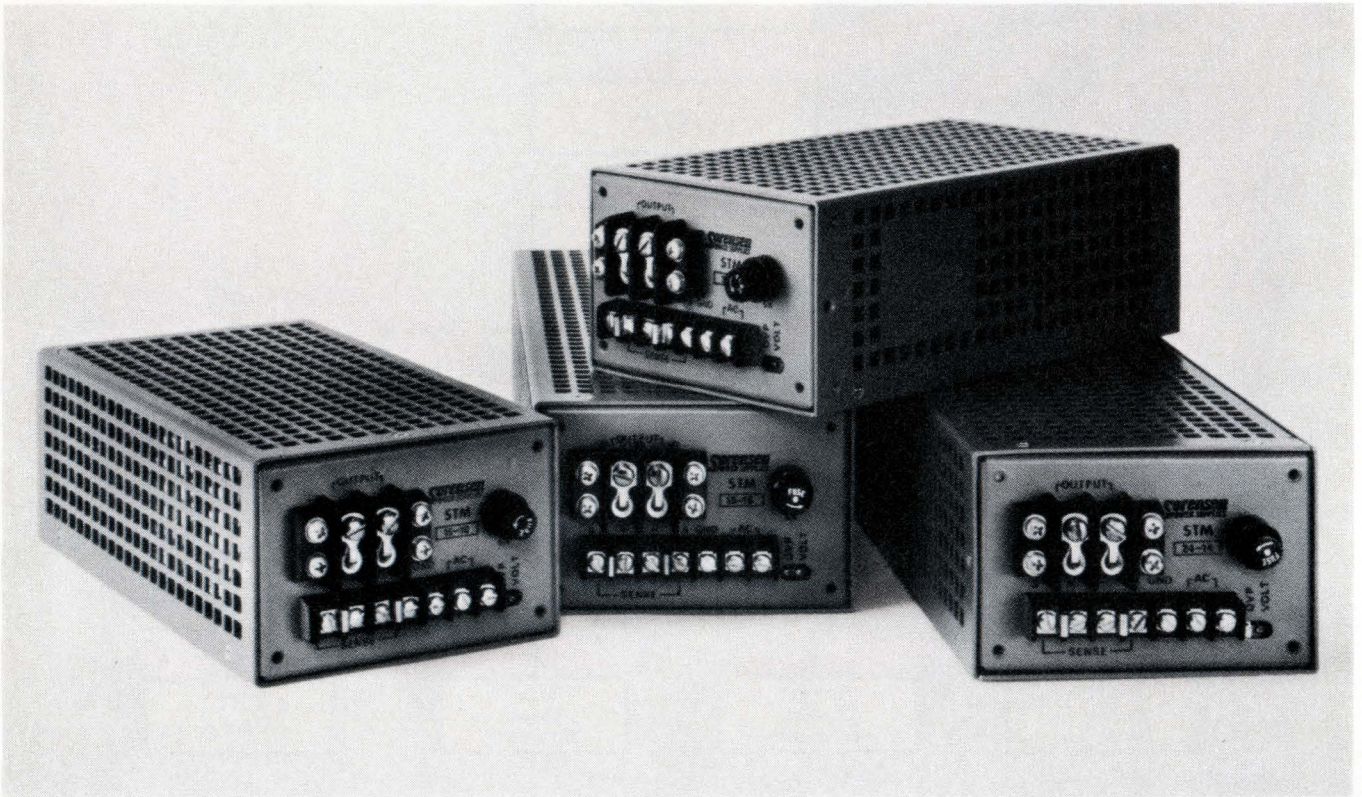

Sorensen's new modular DC power supplies give you twice the efficiency, half the size, for equivalent power ratings.

- **Efficiencies as high as 75%.**
- **Unequaled power outputs — standard package sizes.**
- **Low heat dissipation — eliminates external cooling.**
- **Excellent performance — check the specs.**
- **Built-in overvoltage protection — all units.**
- **Computer optimized filtering — superior RFI and noise performance.**
- **20 models now available — 20 more to come.**

Compared with competitive series-pass power supplies, Sorensen's STM switching-transistor power supplies provide unequalled space and money-saving benefits. And, unlike competitive units, STM power supplies offer overvoltage protection as a standard rather than an optional extra-cost feature.

Sorensen STM's are backed by our world-wide reputation for excellence. For more information write Sorensen Company, a unit of the Raytheon Company, 676 Island Pond Road, Manchester, New Hampshire 03103. Telephone (603) 668-1600. Or, TWX 710-220-1339.

another black box.

Package Size: Module III - 3-5/16" x 5-1/8" x 9-1/2" - Weight: 6.5 lbs.

Model	OUTPUT VOLTAGE Set Range		OUTPUT CURRENT (A _{dc})*				VOLTAGE REGULATION (comb. line and load)	RIPPLE rms p-p**		INPUT POWER					Price†
										AC		DC			
	min.	max.	40°C	50°C	60°C	71°C		Volts	Amps at 115 V	Freq. (Hz)	Volts	Amps at 150 V _{dc}			
STM3.5-24	3.0	4.5	24	19.4	14.9	9.6	.05%	5 mv	50 mv	105-132	1.8	50-440	150±15%	1.5	\$229
STM5-24	4.5	6.0	24	19.4	14.9	9.6	.05%	5 mv	50 mv	105-132	2.3	50-440	150±15%	1.5	229
STM9-12	6.0	10	12	9.7	7.5	4.8	.05%	3 mv	50 mv	105-132	2.1	50-440	150±15%	1.5	239
STM12-12	9.5	13.5	12	9.7	7.5	4.8	.05%	3 mv	50 mv	105-132	2.9	50-440	150±15%	1.5	249
STM15-10	13	17	10	8.1	6.2	4.0	.05%	3 mv	50 mv	105-132	2.7	50-440	150±15%	1.8	239
STM18-10	16	20	10	8.1	6.2	4.0	.05%	3 mv	50 mv	105-132	3.2	50-440	150±15%	1.8	249
STM24-8.5	19	25	8.5	6.8	5.3	3.4	.05%	3 mv	50 mv	105-132	3.3	50-440	150±15%	1.9	249
STM28-7	24	30	7.0	5.6	4.3	2.8	.05%	3 mv	50 mv	105-132	3.2	50-440	150±15%	1.9	249
STM36-4	29	43	4.0	3.2	2.5	1.6	.05%	3 mv	50 mv	105-132	4.0	50-440	150±15%	1.9	259
STM48-4	42	56	4.0	3.2	2.5	1.6	.05%	3 mv	50 mv	105-132	4.0	50-440	150±15%	1.9	269

Package Size: Module IV - 3-5/16" x 5-1/8" x 14" - Weight: 9.0 lbs.

STM3.5-36	3.0	4.5	36	29.1	22.3	14.4	.05%	5 mv	50 mv	105-132	3.8	50-440	150±15%	2.2	319
STM5-36	4.5	6.0	36	29.1	22.3	14.4	.05%	5 mv	50 mv	105-132	4.2	50-440	150±15%	2.5	324
STM9-20	6.0	10	20	16.2	12.4	8.0	.05%	3 mv	50 mv	105-132	3.8	50-440	150±15%	2.2	299
STM12-20	9.5	13.5	20	16.2	12.4	8.0	.05%	3 mv	50 mv	105-132	4.8	50-440	150±15%	2.8	289
STM15-15	13	17	15	12.1	9.3	6.0	.05%	3 mv	50 mv	105-132	4.3	50-440	150±15%	2.6	289
STM18-15	16	20	15	12.1	9.3	6.0	.05%	3 mv	50 mv	105-132	5.0	50-440	150±15%	3.0	299
STM24-13	19	25	13	10.5	8.0	5.2	.05%	3 mv	50 mv	105-132	5.5	50-440	150±15%	3.2	309
STM28-11	24	30	11	8.9	6.8	4.4	.05%	3 mv	50 mv	105-132	5.5	50-440	150±15%	3.2	309
STM36-6	29	43	6.0	4.8	3.7	2.4	.05%	3 mv	50 mv	105-132	4.5	50-440	150±15%	2.6	329
STM48-6	42	56	6.0	4.8	3.7	2.4	.05%	3 mv	50 mv	105-132	5.5	50-440	150±15%	3.2	329

*Free - air rating - no external heatsink **Worst case. Typically less than 30 mv †U.S.A. list prices

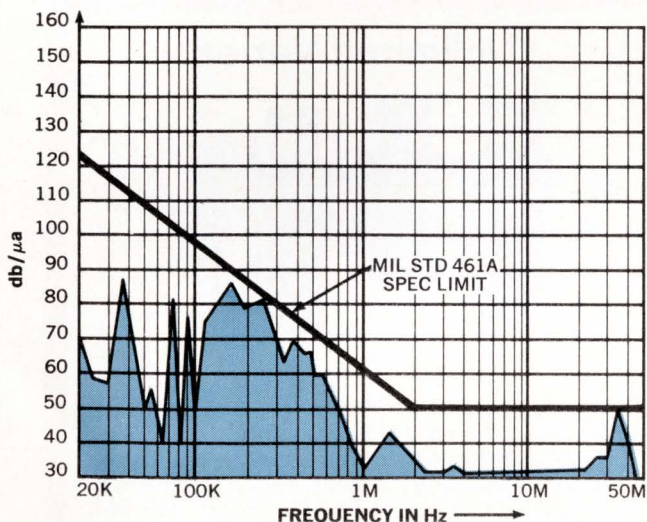

DC Load Leads, Conducted Current Level in db above a Microamp/MHz

Specification	Sorensen STM5-24	Brand "X"
Size	3 ⁵ / ₁₆ x 5 ¹ / ₈ x 9 ¹ / ₂	4 ¹⁵ / ₁₆ x 7 ¹ / ₂ x 9 ³ / ₈
Volume	160 in ³	344 in ³
Price	\$229	\$235
Efficiency	58%	29%
Regulation (line & load combined)	0.05%	0.2%
Temperature Coefficient	0.01 % / °C	0.03% / °C
Overload Protection	Current limiting-adjustable electronic	
Overvoltage Protection	Built-in adjustable, all models	Optional @ \$30 (except built-in, fixed, on 5-volt model only)

Compare this point-by-point spec-check between Sorensen's STM5-24 and Brand "X."

Sorensen POWER SUPPLIES

DATA COMMUNICATIONS PRODUCTS

Programmable front end processor acts as multi-job workhorse

A programmable front end processor, recently announced by Digital Equipment Corp., can be programmed to handle many of the data communications tasks normally performed by the central computer in a teleprocessing network. This means that the front end processor will do line control, message concentration, code conversion, message switching and error control, leaving the host computer for more productive work.

The DECcomm 11D23 is capable of handling data transmission between IBM 360/370 computers and as many as 300 remote terminals.

Touted as a highly flexible system for individual data communications requirements, the minimum DECcomm 11D23 system consists of a PDP-11/20 mini with a 16k byte memory, an ASR 33 Teletype, a programmable 360/370-to-PDP-11 channel interface, a line clock, a serial line interface, and COMTEX

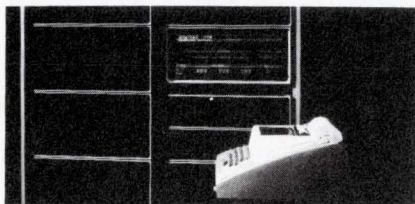

The DECcomm 11D23 programmable front end processor for IBM 360/370 computers relieves the host computer in a teleprocessing network of such data communications tasks as line control, message switching, error control, code conversion, and message concentration.

software. The memory capacity ranges from 16-56k bytes.

The programmable channel interface, called the DX11-B, recognizes as many as 128 IBM device addresses over the full range of 256 addresses. The interface, which can operate in either byte multiplexed or burst mode, can perform as well as an IBM 2848 display controller. In an off-line or powered-down

mode, the unit is transparent to the host computer, presenting no load to the channel or tag line.

Minimum software for the system includes a 2848 display controller terminal application program which emulates the IBM 2848, a Teletype interface interrupt service routine, an interactive Teletype terminal application program, and the COMTEX 11 system control and interface program.

Prices for the system begin at \$30,900. Deliveries are 90 days ARO.

In addition, DEC also announced the DL11 series of asynchronous single line interfaces to handle full or half duplex communications channels and PDP-11 computers. There are five models from \$400 to \$500.

Digital Equipment Corp., Maynard, Mass. 01754.

Circle Reader Service #271

FINGER BUSS

STRIP BUSS

CLIP-ON BUSS

MULTILAYER LAMINATED BUSS BAR

U.S. Pat. #3,582,864

BUSSCO GETS IT ALL TOGETHER...

For less. Circuit board busses replace multi layer boards. Clip-on buss eliminates soldering and wrapping. Noisy, bulky wire harnesses are replaced by laminated buss bars. Call Bussco today.

BUSSCO ENGINEERING INC.
119 Standard St. • El Segundo, Ca. 90245 • (213) 322-6580 • TWX: 910-348-6295

Circle Reader Service #26

DC-10

INDICATORS

Unlimited Variety

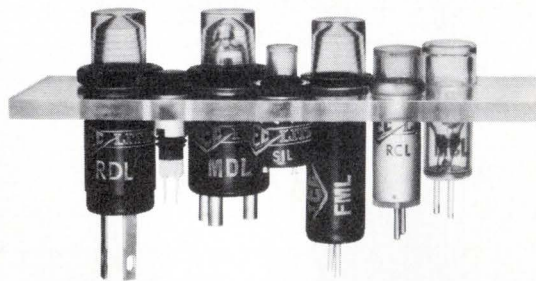

What's your need? TEC has it... electrically designed to cover most supply voltages. Neon or incandescent lamps; wide choice of options including integral switch. Some so compact they mount on 1/4" centers. For information about TEC's complete line of indicators and switches • readouts • display panels • data entry keyboards • CRT display terminals, call (602) 297-1111 or write: **TEC, Incorporated, 9800 N. Oracle Road, Tucson, Arizona 85704.**



Circle Reader Service #27

THE ELECTRONIC ENGINEER • Aug. 1972

UHF/MICROWAVE CAPACITORS

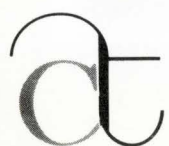
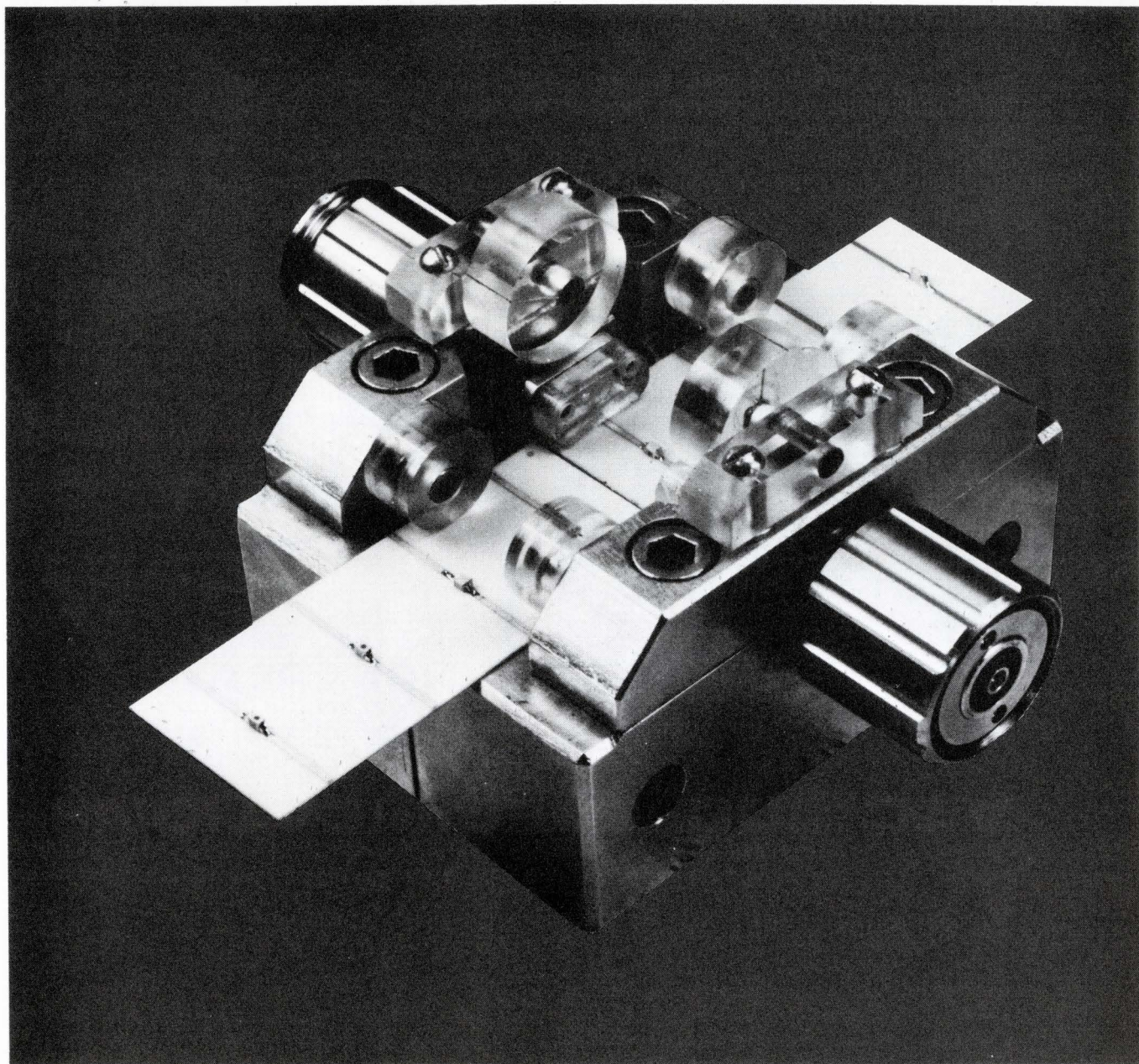

american technical ceramics

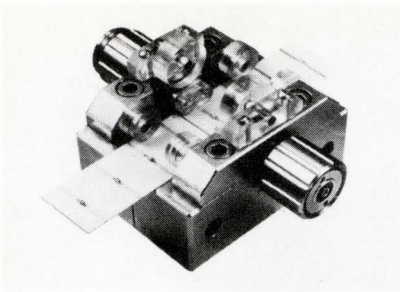

OVER... ATC S PARAMETER TEST FIXTURE

S-Parameter characterization of ATC-100 microwave porcelain capacitors, from 100 MHz to 3 GHz. VSWR, Insertion Loss, S_{11} , S_{21} , X_c and Y_c data (see RF Capacitor Handbook).



COMPANY... AMERICAN TECHNICAL CERAMICS

ATC has been manufacturing fixed, high quality RF capacitors for UHF and microwave equipment for seven years. The Huntington Station plant devotes 7000 square feet of Clean Room area for greenware fabrication, with over 20,000 square feet of modern air conditioned facilities for Q.C., final assembly, and other manufacturing activities. ATC has over 100 employees producing high quality monolithic porcelain and ceramic capacitors.



CIRCUIT DESIGN ENGINEERS

Four experienced RF engineers are available to assist you with your specific application. Dial (516) 271-5112.



CAPACITANCE PER UNIT VOLUME

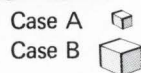

(actual size) to 100,000 pF
(actual size) to 1,000,000 pF (1 MFD)

Request ultra-high
capacitance data sheet.

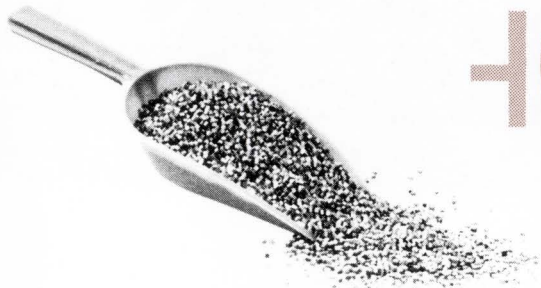

CAPACITORS, CAPACITORS!

Large inventory for fast delivery of chips and leaded types. Dial (516) 271-9668 for fast, firm delivery dates.

ATC CAPACITORS

ATC 100 LOW-LOSS PORCELAIN

(see pp. A4-A9)

Ultra - High Q

Increases gain and power output
Maximizes DC-RF conversion efficiency

High Power

17 Amperes, 3000 Volts, 500 Megahertz

Low Noise

Lowest Equivalent-Noise-Resistance

High Self - Resonance

Allows construction of wideband
discrete-component circuits

Ultra - Stable

Minimal deviation with temperature,
voltage, frequency, time

Rugged

Withstands severe thermal shock
Repeatedly solderable

Hermetic

Impervious even to boiling salt water

ATC 700 ULTRA STABLE CERAMIC

(see pp. A10-A11)

ATC 200 HIGH CAPACITY CERAMIC

(see p. A12)

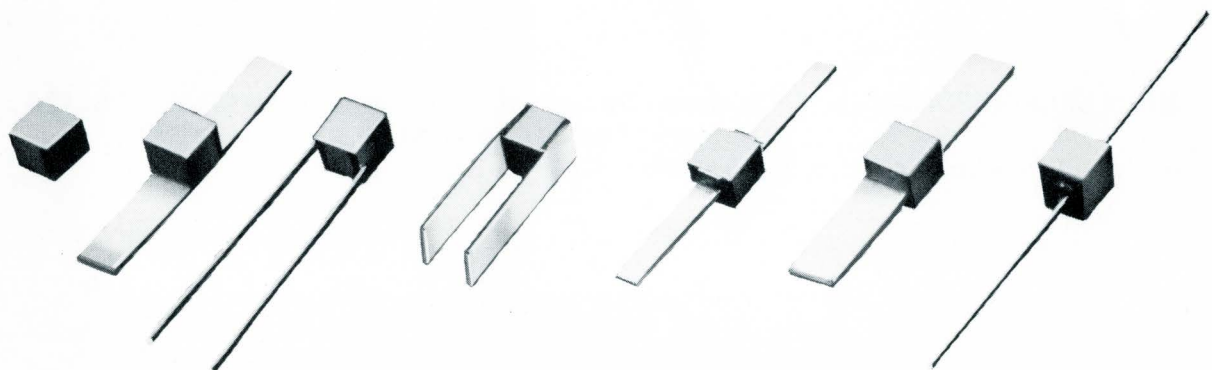

ATC 100

ULTRA HIGH Q is characteristic of the ATC 100 capacitors through microwave frequencies, even at high ambient temperatures, and under extremely high currents, permitting reliable operation at high power levels. Output power increases of greater than 20% per stage are reported when ATC 100's, with their negligible I^2R losses, are substituted for conventional capacitors. The reduction of losses also produces greater DC-to-RF conversion efficiency, improvements of 35% being reported. Improvements in Noise Figure are also attainable in receiver applications.

HIGH-POWER operation thru microwave frequencies. Extremely low R_s and high dielectric strength permit 15 KW pulse operation (900 Watts average) at 500 MHz (3000 Volts, 17 Amps RF) in a 50 Ohm system. Other typical applications are 500 Watts (CW) at 1 GHz and 1 KW (Avg.) at 50 Ohms up to 3 GHz.

LOW NOISE FIGURE in receiving systems is achieved by the very low equivalent series resistance and extremely high Insulation Resistance of the ATC 100's. In an RF preamplifier, their low R_s helped attain a N.F. of 1.4 dB with a 1.2 dB transistor N.F. at 500 MHz. The high Insulation Resistance (ultra-low leakage) of an ATC 100 used as a calibration capacitor at the input of a charge storage amplifier on an X-Ray Spectrometer made possible a threshold sensitivity of 150 eV.

HIGH SELF-RESONANCE is shown by test data taken on a Hewlett Packard 8542A Network Analyzer covering S-Parameters, VSWR, Reactance, and Insertion Loss over the frequency range of 100 to 3000 MHz.

ATC 100

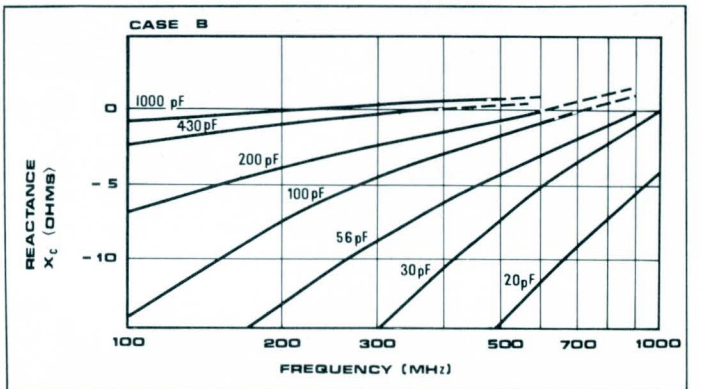
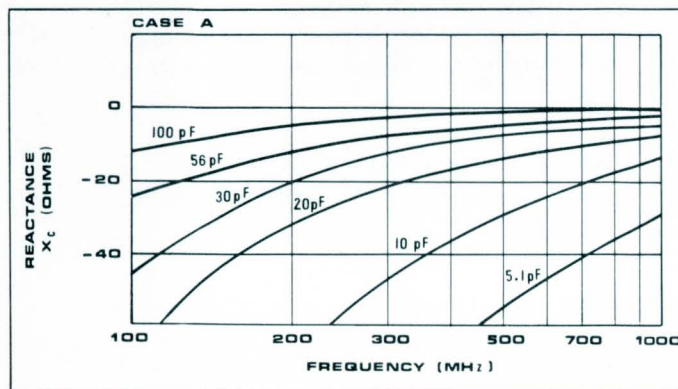
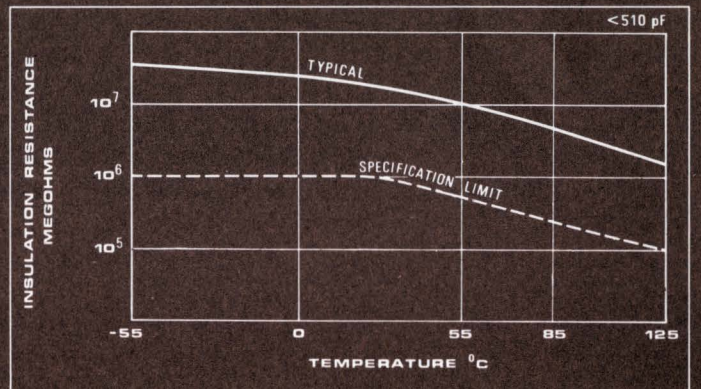
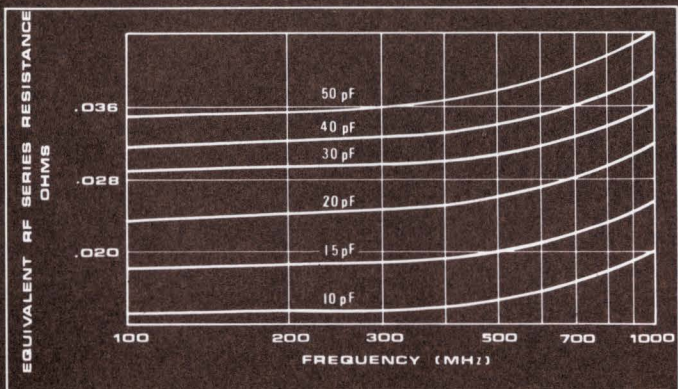
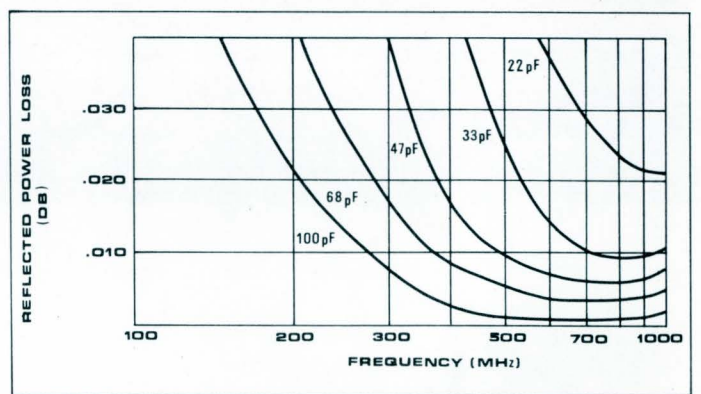
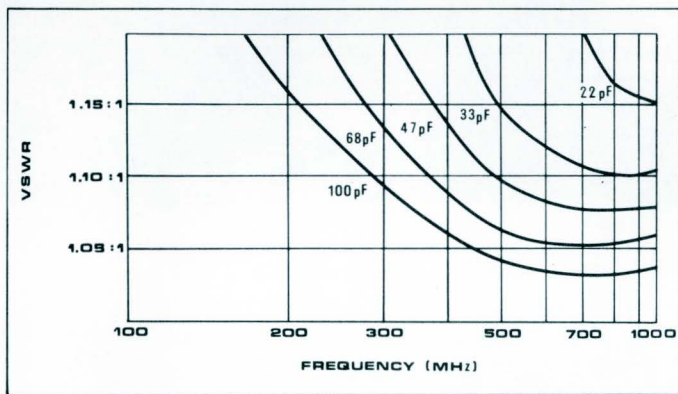
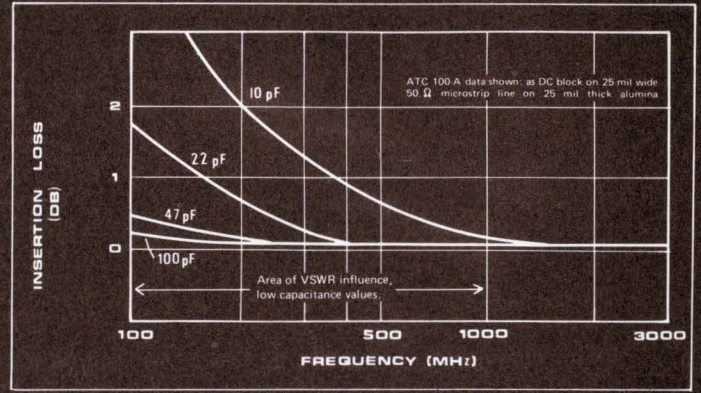
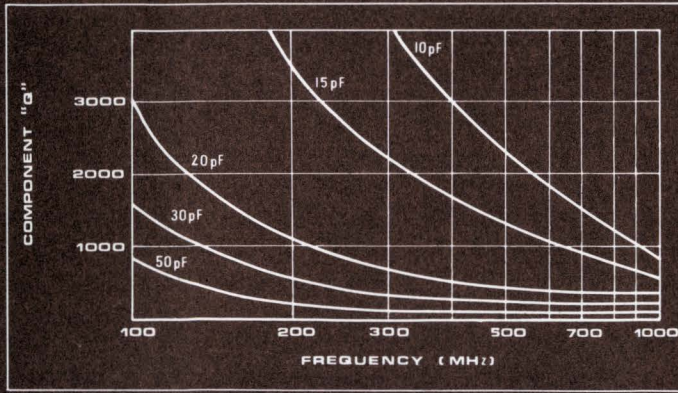

Curves developed in part from data supplied by HP8542A Network Analyzer.

ULTRA-STABLE performance is assured by the self-encapsulating porcelain construction. ATC 100's provide absolute retrace, no measurable drift, and complete stability under extremes of voltage, frequency, time and temperature. They are ideal for high-power, high-current, tuning, or impedance-matching applications.

RUGGED end metallization does not break off under thermal shock; capacitors do not delaminate even if no preheating is used prior to soldering; terminations are not dissolved away by even the most careless soldering.

HERMETIC The severe thermal shock to which capacitors are subjected by direct soldering during circuit assembly can destroy the integrity of conventional capacitors, permitting flux and solvents to penetrate the dielectric. ATC porcelain capacitors are hermetic and are not degraded by the assembly process.

Here is a simple and easy hermeticity test to simulate the thermal shock of soldering and subsequent absorption of contaminants: drop the capacitor into boiling salt water. Remove, wash and verify hermeticity by retesting I.R., capacity, and Q.

CAPACITANCE STABILITY

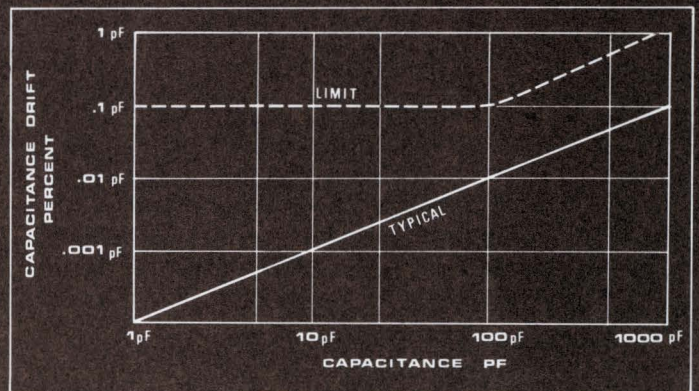
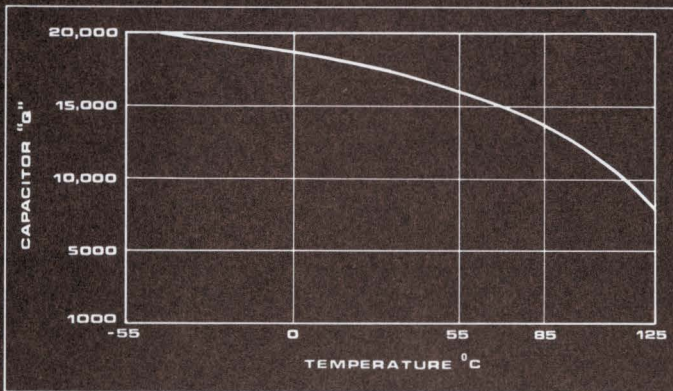
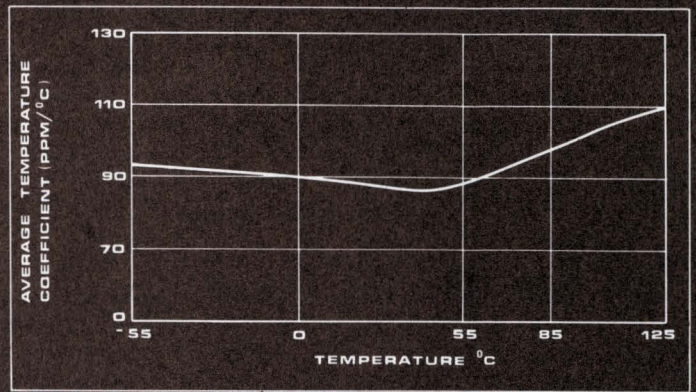
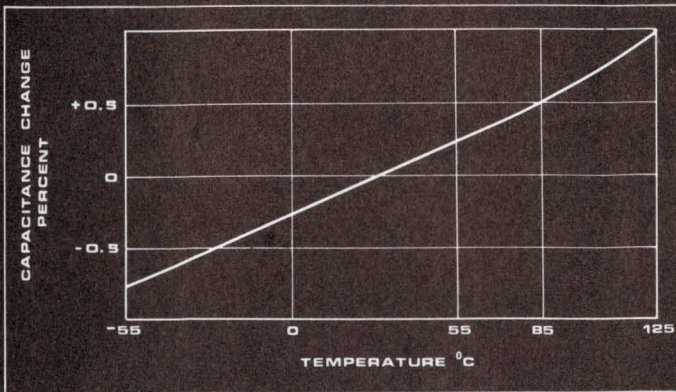

SELF-ENCAPSULATING PORCELAIN CONSTRUCTION

Rare metal internal electrodes are molecularly bonded and sealed in a monolith of non-porous porcelain. The ATC 100 is a hermetic, microminiature, self-encapsulated, high-voltage, porcelain chip capacitor.

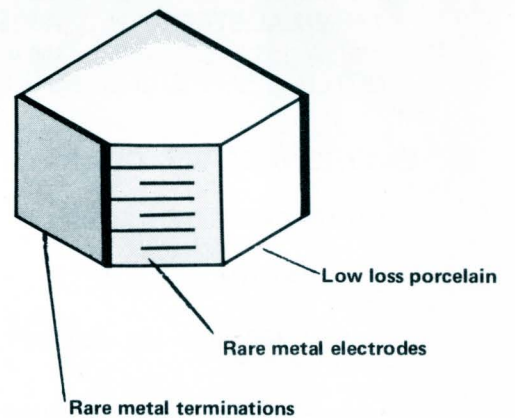

COST ADVANTAGES EXPERIENCED from ATC usage are: increased simplicity of circuit design, shorter equipment development time, and a smooth-flowing production facility. (See RF Capacitor Handbook for specific customer examples.)

ATC 100 SPECIFICATIONS

ELECTRICAL CHARACTERISTICS:

QUALITY FACTOR: (Q_{cap}): greater than 10,000 at 1 MHz.

CAPACITANCE VALUES AND TOLERANCES:

Case A: standard values and tolerances from 0.1 pF to 100 pF (see page A9.)

Case B: standard values and tolerances from 0.1 pF to 1000 pF (see page A9.)

TEMPERATURE COEFFICIENT OF CAPACITANCE: $+90 \pm 20$ PPM/ $^{\circ}$ C (-55° C to 125° C)

DIELECTRIC TEST VOLTAGE: 250% of WVDC rating for 5 secs.

RETRACE: Less than $\pm 0.1\%$.

AGING EFFECTS: None

PIEZOELECTRIC EFFECTS: None (No capacitance variation with voltage or pressure)

CAPACITANCE DRIFT: $\pm 0.1\%$ or 0.1 pF, whichever is greater.

CAPACITANCE RANGE, INSULATION RESISTANCE, AND OPERATING VOLTAGE (WVDC) BY CASE SIZE

CASE A: .1 pF to 100 pF (50 WVDC); 10^6 Megohms Min @ 25° C, 10^5 Megohms Min @ 125° C

CASE B: .1 pF to 100 pF (500 WVDC); 10^6 Megohms Min @ 25° C, 10^5 Megohms Min @ 125° C

110 pF to 200 pF (300 WVDC); 10^6 Megohms Min @ 25° C, 10^5 Megohms Min @ 125° C

220 pF to 470 pF (200 WVDC); 10^6 Megohms Min @ 25° C, 10^5 Megohms Min @ 125° C

510 pF to 620 pF (100 WVDC); 10^5 Megohms Min @ 25° C, 10^4 Megohms Min @ 125° C

680 pF to 1000 pF (50 WVDC); 10^5 Megohms Min @ 25° C, 10^4 Megohms Min @ 125° C

LIFE TEST: 150% rated voltage for 2000 hours at 125° C as per MIL-STD-202C, method 208A (test condition F).

CHANGE IN CAPACITANCE: At 25° C; 0.5% max or 0.5 pF, whichever is greater.

QUALITY FACTOR: greater than 10,000.

INSULATION RESISTANCE: See table above; no degradation.

Standard frequency of measurements, 1 MHz, unless otherwise noted.

MECHANICAL CHARACTERISTICS:

HERMETICITY: The porcelain dielectric is non-porous and impervious to moisture and commonly used cleaning solvents.

TERMINATION STYLES: available in Case A as chips and pellets; Case B units as chips, pellets, and leaded devices. See ATC Capacitor Terminations and Dimensions on page A13.

TERMINAL STRENGTH: All leaded capacitors withstand a lead pull of 5 lbs. for 5 seconds in the axis of the lead per MIL-STD-202 method 211.

OUTLINE DIMENSIONS: See ATC Capacitor Terminations and Dimensions, page A13.

ENVIRONMENTAL CHARACTERISTICS:

MILITARY SPECIFICATIONS: All ATC-100 capacitors meet MIL-C-11272B and MIL-C-23269. (Independent lab test data available.)

TEMPERATURE RANGE: From -55° C to $+125^{\circ}$ C (no derating of working voltage); above 125° C, derate linearly to 50% DCWV @ 200° C.

ATC 100 porcelain capacitors are designed and manufactured to exceed the following requirements of MIL-STD-202:

Barometric pressure	(method 105, cond. B)	Moisture resistance	(method 106)
Shock	(method 213, cond. J)	Solderability	(method 208)
Vibration	(method 204, cond. B)	Terminal Strength	(method 211)
Temperature Cycling	(method 102, cond. C)	Salt Spray	(method 101, cond. B)
Immersion	(method 104, cond. B)		

ATC SW 100 BOILING SALT WATER TEST: Thermal Shock and Hermeticity Test

PURPOSE: To provide a non-destructive, simulation of the thermal shock and degradation caused by contaminant absorption experienced during normal circuit mounting and "cleaning".

PROCEDURE: With plastic tweezers, drop capacitors into a boiling salt water solution. Remove after two hours, wash thoroughly (distilled water), then dry at 150° C for 10 minutes.

MEASURE: I.R., capacity, and Q (shall be within published specifications).

ATC 100 CAPACITY VALUES

CAP CODE	CAP (pF)	TOL	WVDC 125°C	CAP CODE	CAP (pF)	TOL	WVDC 125°C	CAP CODE	CAP (pF)	TOL	WVDC 125°C
0R1	0.1	B	500	4R3	4.3	BCD	500	680	68	FGJKM	500
0R2	0.2	B	500	4R7	4.7	BCD	500	750	75	FGJKM	500
0R3	0.3	BC	500	5R1	5.1	BCD	500	820	82	FGJKM	500
0R4	0.4	BC	500	5R6	5.6	BCD	500	910	91	FGJKM	500
0R5	0.5	BCD	500	6R2	6.2	BCD	500	101	100	FGJKM	500
0R6	0.6	BCD	500	6R8	6.8	BCJKM	500	111	110	FGJKM	300
0R7	0.7	BCD	500	7R5	7.5	BCJKM	500	121	120	FGJKM	300
0R8	0.8	BCD	500	8R2	8.2	BCJKM	500	131	130	FGJKM	300
0R9	0.9	BCD	500	9R1	9.1	BCJKM	500	151	150	FGJKM	300
1R0	1.0	BCD	500	100	10	FGJKM	500	161	160	FGJKM	300
1R1	1.1	BCD	500	110	11	FGJKM	500	181	180	FGJKM	300
1R2	1.2	BCD	500	120	12	FGJKM	500	201	200	FGJKM	300
1R3	1.3	BCD	500	130	13	FGJKM	500	221	220	FGJKM	200
1R4	1.4	BCD	500	150	15	FGJKM	500	241	240	FGJKM	200
1R5	1.5	BCD	500	160	16	FGJKM	500	271	270	FGJKM	200
1R6	1.6	BCD	500	180	18	FGJKM	500	301	300	FGJKM	200
1R7	1.7	BCD	500	200	20	FGJKM	500	331	330	FGJKM	200
1R8	1.8	BCD	500	220	22	FGJKM	500	361	360	FGJKM	200
1R9	1.9	BCD	500	240	24	FGJKM	500	391	390	FGJKM	200
2R0	2.0	BCD	500	270	27	FGJKM	500	431	430	FGJKM	200
2R1	2.1	BCD	500	300	30	FGJKM	500	471	470	FGJKM	200
2R2	2.2	BCD	500	330	33	FGJKM	500	511	510	FGJKM	100
2R4	2.4	BCD	500	360	36	FGJKM	500	561	560	FGJKM	100
2R7	2.7	BCD	500	390	39	FGJKM	500	621	620	FGJKM	100
3R0	3.0	BCD	500	430	43	FGJKM	500	681	680	FGJKM	50
3R3	3.3	BCD	500	470	47	FGJKM	500	751	750	FGJKM	50
3R6	3.6	BCD	500	510	51	FGJKM	500	821	820	FGJKM	50
3R9	3.9	BCD	500	560	56	FGJKM	500	911	910	FGJKM	50
				620	62	FGJKM	500	102	1000	FGJKM	50



CASE A mini-cubes[®] * are available from 0.1 pF through 100 pF in the values and tolerances listed above; working voltages 50 VDC, to +125°C. Case A capacitors may also be obtained with a working voltage of 100 VDC on special order.

CASE B MAXI-"Q"UBES[™] * are available in all values and tolerances at the working voltages shown in the table above. The Case B size may be ordered with a rating of 1000 WVDC, 0.1 pF to 47 pF, or with a rating of 100 WVDC, 680 pF to 1000 pF. To order, specify new WVDC in the ordering code.

TOLERANCE CODE; B = ±0.1 pF; C = ±0.25 pF; D = ±0.5 pF; F = ±1%; G = ±2%; J = ±5%; K = ±10%; M = ±20%

*CASE A mini-cubes[®] is a registered trademark of ATC. *CASE B MAXI-"Q"UBES[™] is a proprietary trademark of ATC.

ATC 700 ULTRA STABLE CERAMIC

- T.C. = 0 ± 30 PPM/ $^{\circ}\text{C}$ (-55°C to $+125^{\circ}\text{C}$)
- To 1000 pF in a 55 mil cube Case A  (actual size)
- Highest packaging density of any NPO capacitor
- To 5100 pF in a 110 mil cube Case B  (actual size)
- No capacitance change with voltage

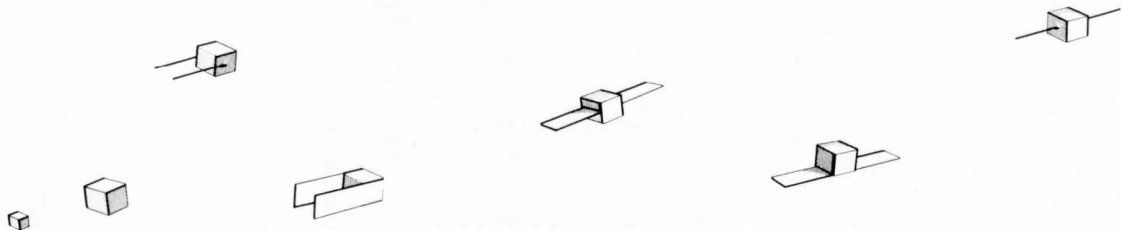

APPLICATIONS

Excellent for low power levels at UHF frequencies as DC blocks and emitter bypasses superior in VHF low power high-stability tank circuits for variable-frequency oscillators, and H.F. discriminators reduces variation due to temperature in low frequency filters permits predictable RC timing circuits replaces mica, polystyrene and teflon dielectric capacitors with much greater capacity values per unit volume and improved environmental characteristics.

CHARACTERISTICS

CAPACITY VALUES: Case A, all standard RETMA values from 47 pF to 1000 pF.
Case B, all standard RETMA values from 200 pF to 5100 pF.

TOLERANCES: F ($\pm 1\%$), G ($\pm 2\%$), J ($\pm 5\%$), K ($\pm 10\%$), and M ($\pm 20\%$).

WORKING VOLTAGE: 50 WVDC

TEMPERATURE COEFFICIENT OF CAPACITANCE: 0 ± 30 PPM/ $^{\circ}\text{C}$ (-55°C to $+125^{\circ}\text{C}$)

DISSIPATION FACTOR: .0005 max @ 1 KHz except .001 for Case A > 470 pF.

INSULATION RESISTANCE: 10^5 megohms minimum @ 25°C ; 10^4 megohms minimum @ 125°C

DIELECTRIC TEST VOLTAGE: 300% rated voltage for 5 seconds.

OPERATING TEMPERATURE RANGE: -55°C to $+125^{\circ}\text{C}$.

MILITARY SPECIFICATIONS: ATC 700 capacitors meet MIL-C-55681.

Termination Styles: Available in Case A as chips and pellets; Case B units as chips, pellets, and leaded devices. See ATC Capacitor Terminations and Dimensions, page A13.

ATC 700 CAPACITY VALUES

CASE A

CAP. CODE	CAP. PF	CAP. CODE	CAP. PF
470	47	221	220
510	51	241	240
560	56	271	270
620	62	301	300
680	68	331	330
750	75	361	360
820	82	391	390
910	91	431	430
101	100	471	470
111	110	511	510
121	120	561	560
131	130	621	620
151	150	681	680
161	160	751	750
181	180	821	820
201	200	911	910
		102	1000



CASE B

CAP. CODE	CAP. PF	CAP. CODE	CAP. MF
201	200	112	.0011
221	220	122	.0012
241	240	132	.0013
271	270	152	.0015
301	300	162	.0016
331	330	182	.0018
361	360	202	.002
391	390	222	.0022
431	430	242	.0024
471	470	272	.0027
511	510	302	.0030
561	560	332	.0033
621	620	362	.0036
681	680	392	.0039
751	750	432	.0043
821	820	472	.0047
911	910	502	.005
102	1000	512	.0051

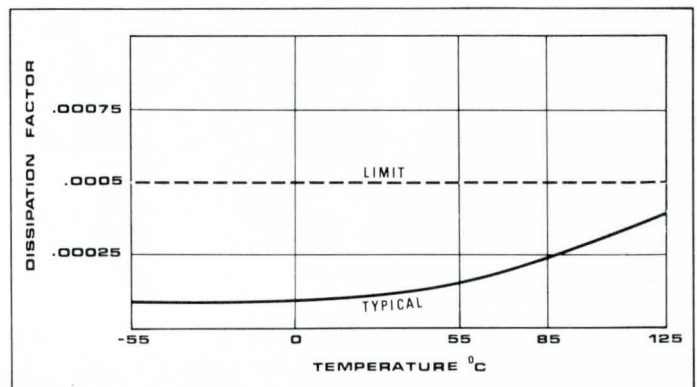
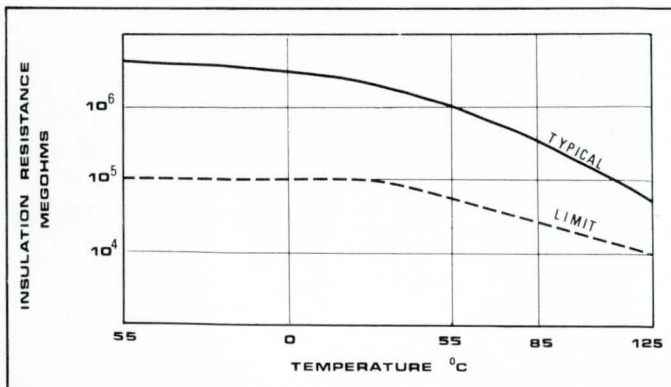
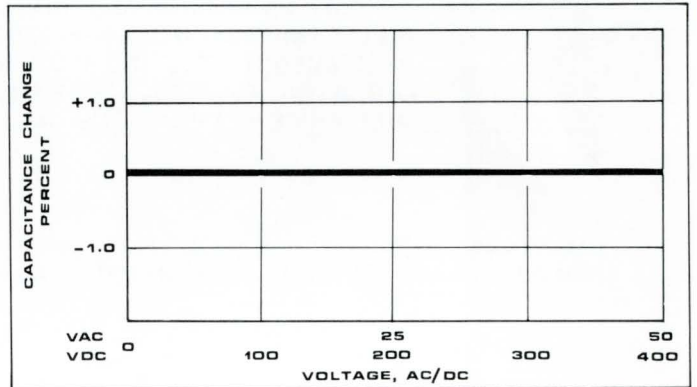
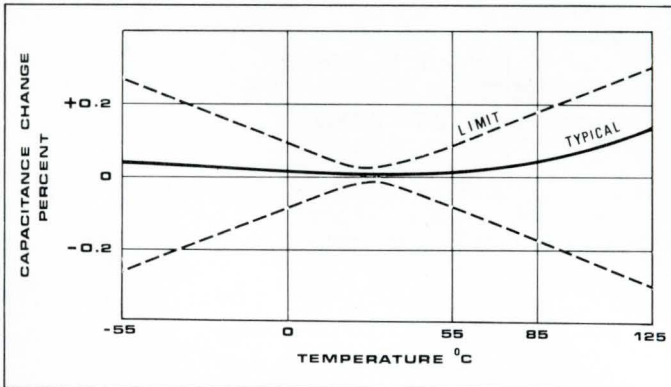
CAPACITANCE STABILITY



ATC 200 HIGH CAPACITY CERAMIC

- 10,000 pF in 55 mil case Case A  (actual size)
- 100,000 pF in 110 mil case Case B  (actual size)
- Temperature range -55°C to $+125^{\circ}\text{C}$
- 50 WVDC

CHARACTERISTICS

CAPACITY VALUES: Case A, standard values from 510 pF to .01 MF
 Case B, standard values from .005 MF to 0.1 MF
 TOLERANCES: K($\pm 10\%$), M($\pm 20\%$), and N($\pm 30\%$)
 WORKING VOLTAGE: 50 WVDC (25 WVDC from 85°C to 125°C)
 CAPACITANCE CHANGE WITH TEMPERATURE: $\pm 15\%$ maximum (-55°C to $+125^{\circ}\text{C}$)
 DISSIPATION FACTOR: 2.5% maximum @ 1 KHz
 INSULATION RESISTANCE: 10,000 megohms minimum
 DIELECTRIC TEST VOLTAGE: 150 VDC for 5 secs
 RECOMMENDED TESTING SEQUENCE: Cap., DF, IR, Dielectric Test Voltage
 OPERATING TEMPERATURE RANGE: -55°C to $+125^{\circ}\text{C}$
 MILITARY SPECIFICATIONS: meet applicable portions of MIL-C-11015D

Termination Styles: Available in Case A as chips and pellets; Case B units as chips, pellets, and leaded devices. See ATC Capacitor Terminations and Dimensions, page A13.

CASE A



CAP. CODE	CAP. PF	CAP. CODE	CAP. MF
511	510	202	.002
561	560	222	.0022
621	620	272	.0027
681	680	332	.0033
751	750	392	.0039
821	820	472	.0047
911	910	502	.005
102	1000	562	.0056
122	1200	682	.0068
152	1500	822	.0082
182	1800	103	.01

CASE B



CAP. CODE	CAP. MF	CAP. CODE	CAP. MF
502	.005	273	.027
562	.0056	333	.033
682	.0068	393	.039
822	.0082	473	.047
103	.01	503	.05
123	.012	563	.056
153	.015	683	.068
183	.018	823	.082
203	.02	104	.1
223	.022		

ATC CAPACITOR TERMINATIONS AND DIMENSIONS







CASE A AND B CHIPS

CODE	CASE SIZE	TYPE	OUTLINE AND TERMINATION MATERIAL * W/T IS A TERMINATION SURFACE	DIMENSIONS		
				LENGTH	WIDTH	THICKNESS
C	A	 Chip	Palladium Silver (PdAg)	.055 ± .010 in. 1.4 ± .25 mm.		.055 in. max. 1.4 mm. max.
C	B	 Chip		.110 ± .015 in. 2.79 ± .38 mm.		.100 in. max. 2.54 mm. max.

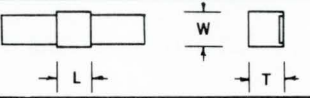
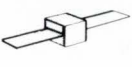
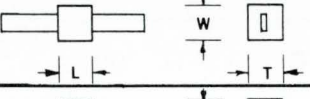
CASE A AND B PELLETS (chip terminations solder coated)

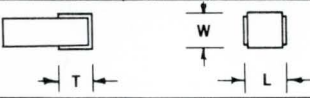
CODE	CASE SIZE	TYPE	OUTLINE AND TERMINATION MATERIAL * W/T IS A TERMINATION SURFACE	DIMENSIONS		
				LENGTH	WIDTH	THICKNESS
P	A	 Pellet	372°F solder, 62% Sn, 36% Pb, 2% Ag	.070 in. max. 1.78 mm. max.	.055 ± .010 in. 1.4 ± .25 mm.	.055 in. max. 1.4 mm. max.
P	B	 Pellet		565°F solder 5% Sn, 93.5% Pb, 1.5% Ag	.130 in. max. 3.30 mm. max.	.110 ± .015 in. 2.79 ± .38 mm.

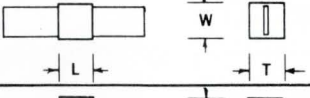
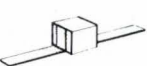
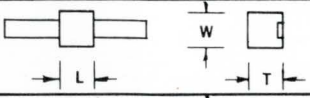
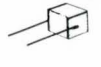
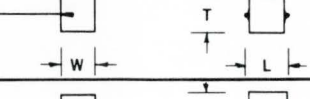
CASE B SILVER RIBBON AND SILVER WIRE LEADS

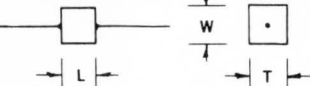
CODE	LEAD STYLE	DIMENSIONS L = .135 ± .015 in.; 3.43 ± .38 mm. W = .110 ± .015 in.; 2.79 ± .38 mm. T = .100 in. max.; 2.54 mm. max.	LEAD DIMENSIONS		
			LENGTH	WIDTH	THICKNESS
MS	<i>Micro-strip</i> 		.250 in. min. 6.35 mm. min.	0.93 ± .005 in. 2.36 ± .13 mm.	.004 ± .001 in. .102 ± .025 mm.
AR	<i>Axial Ribbon</i> 				
RR	<i>Radial Ribbon</i> 				
NAR	<i>Narrow Axial Ribbon</i> 				
NMS	<i>Narrow Micro-strip</i> 				
RW	<i>Radial Wire</i> 		.500 in. min. 12.7 mm. min.	#26 AWG, nom. .016 in. dia. nom. .375 mm. dia.	
AW	<i>Axial Wire</i> 				

HIGH TEMPERATURE brazed lead withstands 1500°F. These extra-rugged leaded capacitors can be ordered by adding the suffix (HT) to the ATC Termination Code; for example, MS(HT).

CAPACITORS MARKED with ATC logo, capacity, and tolerance code are available for any case B size (including chips and pellets). To order, add suffix (X) to code.

CAPACITOR SELECTOR

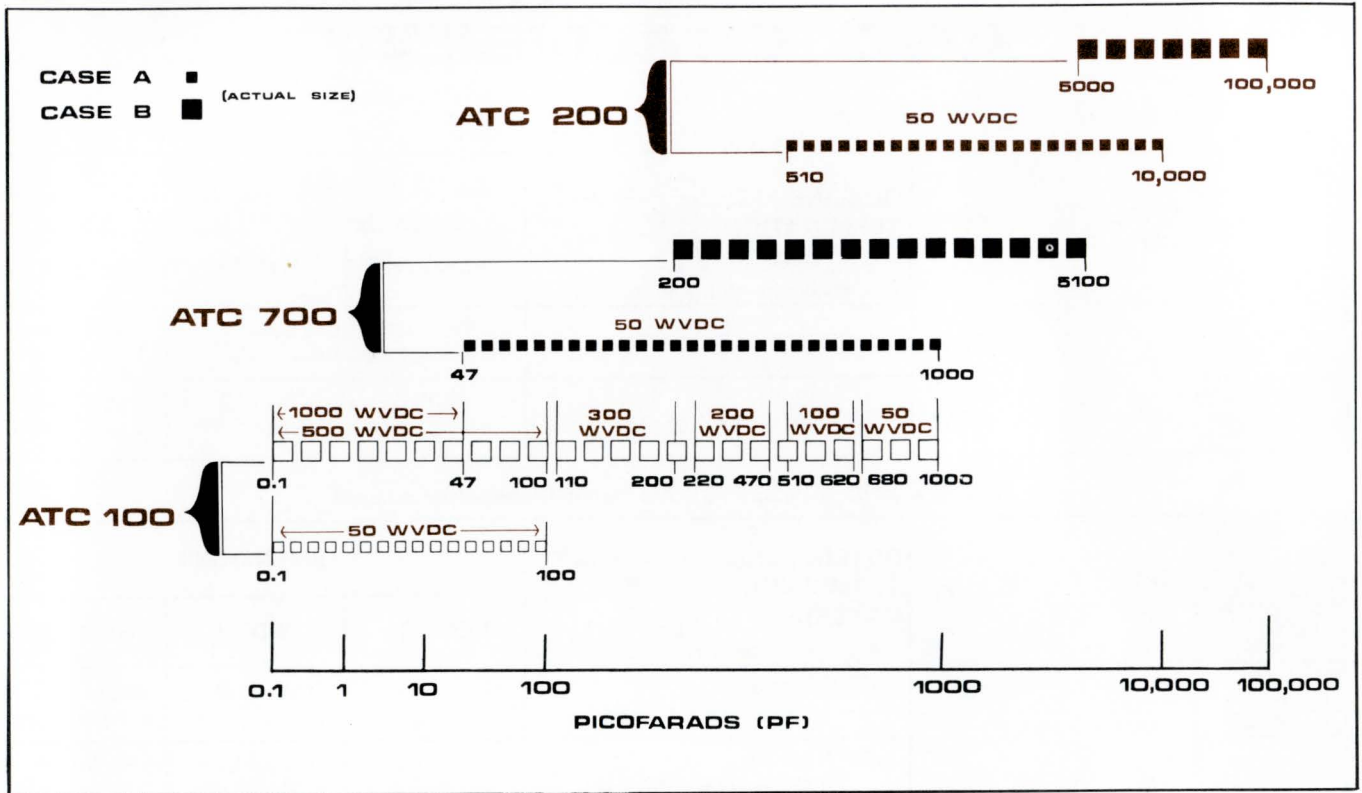

ORDERING CODE:

The specimen part number shown below (ATC 100-B-910-F-AW-500) designates ATC 100 dielectric, B size case, 91 pF ±1%, with axial wire leads, 500 WVDC.

ATC 100	ATC SERIES (ATC 100, ATC 700, or ATC 200)	
B	CASE SIZE (A or B)	
910	CAPACITANCE (CODE):	ATC 100, page A9; ATC 700, page A11; ATC 200, page A12.
F	TOLERANCE (CODE):	
AW	LEAD STYLE (CODE): page A13.	
500	WORKING VOLTAGE (D.C.)	

ATC has made every effort to have this information as accurate as possible. However, no responsibility is assumed by ATC for its use, nor for any infringements of rights of third parties which may result from its use. ATC reserves the right to revise the content or modify its product line without prior notice.

Mfg. Ident. #29990

ATC SALES REPRESENTATIVES

ALABAMA

FM Associates Ltd.
P.O. Box 1368
Huntsville, Ala. 35807
Tel: (205) 772-3668

ARIZONA

Jerid Marketing Specialists, Inc.
P.O. Box 900
Tempe, Arizona 85251
Tel: (602) 967-8861

ARKANSAS

Parvin Sales
P.O. Box 307
Addison, Texas 75001
Tel: (214) 239-9148

CALIFORNIA (north)

Allgood North
2680 Bayshore Frontage Rd.
Mountain View, Calif. 94040
Tel: (415) 961-9686

CALIFORNIA (south)

Wright Engineering Company, Inc.
P.O. Box 111
Burbank, Calif. 91503
Tel: (213) 843-7240
Tel: (213) 843-7262

CONNECTICUT

Wayland Engineering Sales
P.O. Box 189
Wayland, Mass. 01778
Tel: (617) 655-6080

CONNECTICUT (Fairfield County)

Call factory direct

DELAWARE

V.P.I. Associates, Inc.
13001 Misteltoe Road
Laurel, Md. 20810
Tel: (301) 792-7631

FLORIDA

FM Associates Ltd.
5018 Mortier Avenue
Orlando, Florida 32809
Tel: (305) 851-5710

GEORGIA

See Alabama listing

ILLINOIS (north)

Communications Engineers
7106 North Western Avenue
Chicago, Illinois 60645
Tel: (312) 761-0548

ILLINOIS (south)

Harris-Hanson Company
2814 S. Brentwood Blvd.
St. Louis, Mo. 63144
Tel: (314) 962-0111

INDIANA

See Illinois (north) listing

IOWA

See Illinois (north) listing

KANSAS

See Illinois (south) listing

LOUISIANA

See Arkansas listing

MAINE

See Connecticut listing

MARYLAND

See Delaware listing

MASSACHUSETTS

See Connecticut listing

MISSOURI

See Illinois (south) listing

NEW HAMPSHIRE

See Connecticut listing

NEW JERSEY (north)

Call factory direct

NEW JERSEY (south)

Megargel/Himmelstein Associates
3501 Haddonfield Road
Pennsauken, N.J. 08109
Tel: (609) 662-3081
Tel: (215) 629-1072

NEW YORK (metro)

Call factory direct

NEW YORK (Rochester and west)

April's Instrument Service
Genesee County Airport
State Street Road
Batavia, N.Y. 14020
Tel: (716) 343-0456

NEW YORK (east of Rochester)

R & D Associates
109 Woods Path Road
Liverpool, N.Y. 13088
Tel: (315) 622-2350

NORTH CAROLINA

FM Associates Ltd.
904 Montrose Drive
Greensboro, N.C. 27410
Tel: (919) 294-2754

OKLAHOMA

See Arkansas listing

PENNSYLVANIA (east)

See New Jersey (south) listing

RHODE ISLAND

See Connecticut listing

SOUTH CAROLINA

See North Carolina listing

TEXAS

See Arkansas listing

VERMONT

See Connecticut listing

VIRGINIA (north)

See Delaware listing

VIRGINIA (south)

See North Carolina listing

WASHINGTON D.C.

See Delaware listing

ENGLAND

Guest International, Ltd.
Nicholas House
Thornton Heath
Brigstock Road
Surrey, CR4 7JA
England
Tel: 01-689 2121

FRANCE

CEREL
Constructions et Recherches
Electro-Mecaniques
14-16 rue des Lilas
Paris, 19e, France
Tel: 202-67-20 +C.C.P. 2787-50

GERMANY

Electronic Components & Instruments
8 Munchen 83
Adolf-Baeyer Damm, 36
West Germany
Tel: (0811) 40 77 25

ITALY

Exhibo Italiana
20052 Monza
Via S. Andrea, 6
Italy
Tel: 360021

SWEDEN

Komponentbolaget NAX AB
Bjornsonsgatan 205
161 56 Bromma,
Sweden
Tel: 08/37 29 45

TO CALL FACTORY DIRECT:

Order Control: (516) 271-9668

Circuit Design: (516) 271-5112

General Information: (516) 271-9600



24 Hour TWX Service: 510-226-6993

THE RF CAPACITOR HANDBOOK

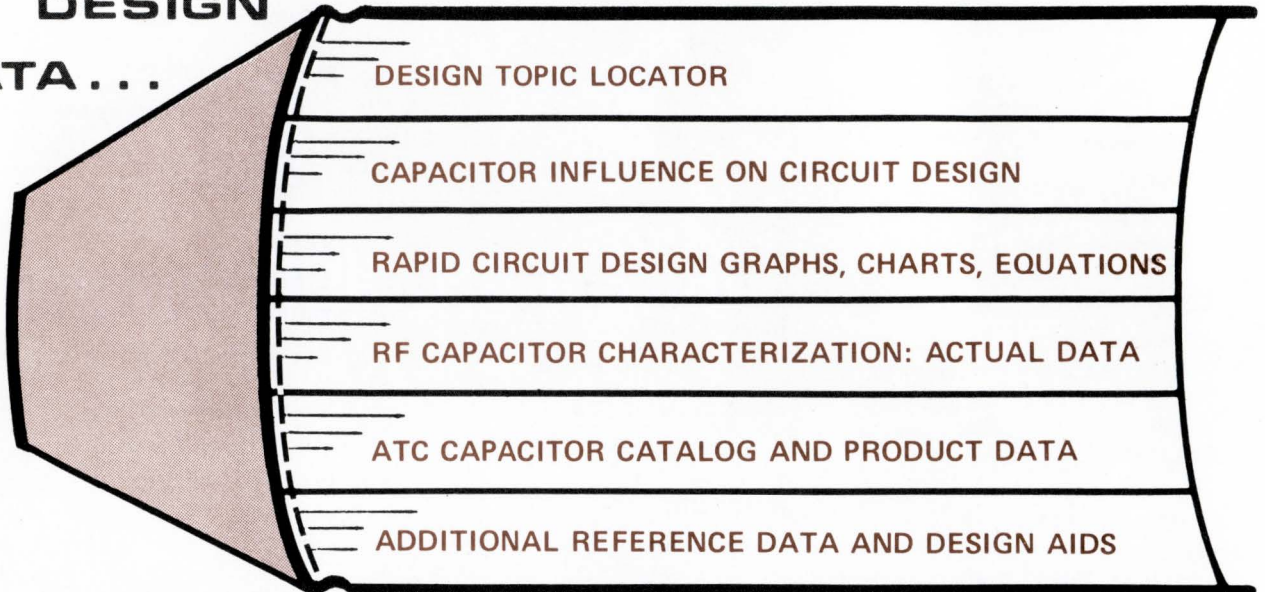
OVER 200 PAGES
OF DESIGN
DATA...

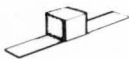

SENT FREE WITH YOUR ORDER FOR ANY
ATC UHF/MICROWAVE CAPACITOR KIT

\$49.95 KIT 1	<i>Microstrip Lead</i> <i>Case B</i> 	60 ATC 100 capacitors, four each of the following values and tolerances:									
		pF	Tol.	pF	Tol.	pF	Tol.	pF	Tol.	pF	Tol.
		1.0	C	5.1	D	16	J	51	J	200	J
		2.2	D	7.5	D	24	J	75	J	470	M
		3.6	D	11	J	36	J	100	J	820	M
\$49.95 KIT 2	<i>Minicube® Chips</i> <i>Case A</i> 	125 ATC 100 capacitors, five each of the following values and tolerances:									
		pF	Tol.	pF	Tol.	pF	Tol.	pF	Tol.	pF	Tol.
		1.0	B	2.7	D	6.8	K	18.0	K	47	K
		1.3	B	3.3	D	8.2	K	22.0	K	56	K
		1.6	C	3.9	D	10.0	K	27	K	68	K
		1.9	C	4.7	D	12.0	K	33	K	82	K
		2.1	C	5.6	D	15.0	K	39	K	100	K
\$19.95 KIT 3	<i>Minicube® Chips</i> <i>Case A</i> 	40 ATC 100 capacitors, four each of the following values and tolerances:									
		pF	Tol.	pF	Tol.	pF	Tol.	pF	Tol.	pF	Tol.
		1.0	B	2.7	D	4.7	D	12.0	K	47	K
		1.8	C	3.3	D	8.2	K	22.0	K	100	K

® Minicubes is a registered trademark of ATC.

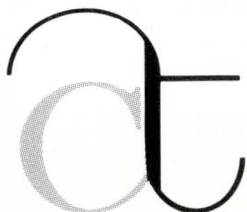

american technical ceramics

1 NORDEN LANE, HUNTINGTON STATION, N. Y. 11746

516/271-9600 • TWX-510-226-6993

2400 B/S INTEGRAL MODEM

Claimed as the first integral modem to provide fully automatic answer operation at 2400 b/s over the switched telephone network, this unit is a four-phase, differential PSK modem. The Model 2012 offers higher speed operation than the 2000 b/s Bell 201A and, when used with Intertel's 150-baud reverse channel, represents the only dial-up modem available with automatic answer interface and reverse channel other than the lower speed Bell 202C. Standard features include answer back tone, automatic answering, carrier detect, clear to send delay, external/internal transmitter timing, local copy, receiver squelch, and MARK hold on receive data when carrier is lost. Intertel, Inc. 6 Vine Brook Pk., Burlington, Mass. 01803.

Circle Reader Service #272

TTY-COMPATIBLE DISPLAY

This low-cost, CRT display terminal with a keyboard is meant as a replacement for Teletype Models 33 or 35. Using the 7-bit (plus parity) ASCII code, Asciscope displays are compatible with communication software designed to interact with Model 33 and 35 Teletypes. A built-in acoustic coupler provides dial-up communication on any telephone handset via the built-in 110/330 b/s modem. Alternately, Asciscope displays can be directly connected to communication lines via a Data Access Arrangement, CDT. Interfaces are also available for use with external modems which operate at speeds of 1200 or 2400 b/s. Lease \$65/mo. ITT Data Equipment & Systems Div., E. Union Ave., E. Rutherford, N.J. 07073.

Circle Reader Service #273

MUX TEST SET

This self-powered test set functions by generating and detecting character patterns and control signals sent and received at std data rates and voltages. The set functions at switch-selectable rates of 50, 75, 110, 134.5, 150 and 300 baud, plus one additional rate programmable up to 1200 baud. Also selectable are codes 7, 7.5, 9, 10 and 11 b/char. with odd or even parity. \$935 stock. Timeplex Inc., Box 202, 65 Oak St., Norwood, N.J. 07648.

Circle Reader Service #274

It's here!

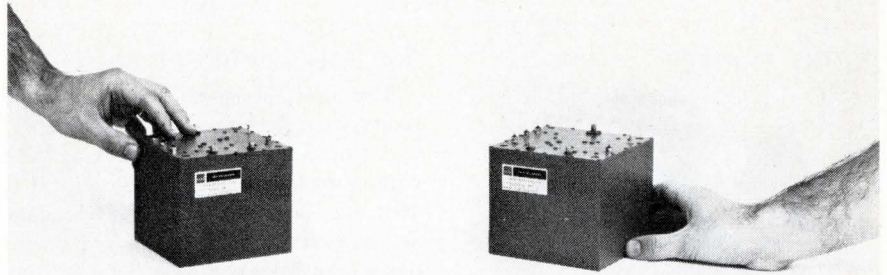

4-12.4 GHz VCO Coverage

VCO frequency ranges are pushed to a new high by the WJ-2834 and WJ-2835 series of solid state signal sources. Designed to meet MIL-E-5400, Class 2, environmental specifications, these ultra-stable oscillators provide 25 mW minimum power output anywhere in the 4 to 12.4 GHz range. Higher power levels are available for narrowband applications. These devices can be manufactured using all Established Reliability or JAN-TX parts or equivalent for high reliability applications.

Units may be ordered with any combination of isolators, heaters, filters and linearizers. Their effect on overall performance is quite dramatic; details are available upon request. Specifications for both series are shown in the table below.

SPECIFICATIONS

Frequency Range	4 to 8 GHz (WJ-2834 series) 8 to 12.4 GHz (WJ-2835 series)
Power Output	25 mW min.
Harmonic, Subharmonic and Spurious Levels	-45dBm (in-band) -70dBm (out-of-band)
Frequency Pulling (2:1 VSWR)	±0.5%
Frequency Pushing	20 MHz/V
Power Requirements	±12 Vdc at 900 mA 35 Vdc at 50 mA 115 Vac at 2A
Tuning Voltage	0 Vdc min. (low end) 10 Vdc max. (high end)
Operating Temperature Range	-55°C to +85°C
Size (each unit)	5 × 5 × 5 inches (127 × 127 × 127 mm)



WATKINS-JOHNSON

3333 HILLVIEW AVE., STANFORD INDUSTRIAL PARK, PALO ALTO, CALIF. 94304 • (415) 493-4141

Circle Reader Service #28

DIGITAL PRINTER

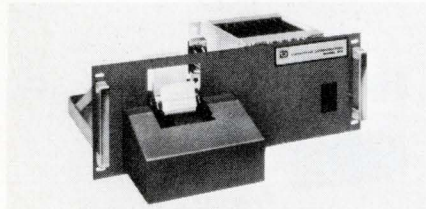

A new printer, 3 line/s, uses a standard format of 10 characters/linear in. and six lines/vertical in. The Model 318 printer, 6- to 18-column, features zero suppression, fully buffered memory, and serial or parallel input. Datadyne Corp., 37A Valley Forge Ctr., King of Prussia, Pa. 19406.

Circle Reader Service #275

SPIRAL ANTENNAS

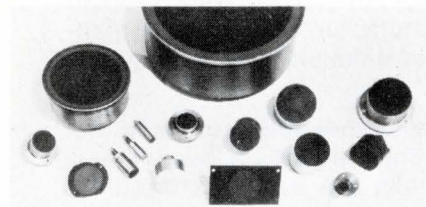

Sixteen new models cover frequencies from 0.5 MHz through 18 GHz. Phase and amplitude tracking models in either right- or left-hand polarization. Sizes from 0.625 to 12.6 in. dia. American Nucleonics, 6036 Variel, Woodland Hills, Calif. 91364.

Circle Reader Service #276

DEMAND DIVISION MUX

A new multiplexing technology, demand division, is eliminating the add-on costs of additional ports into the CPU; extra modems; added line charges and software rewrites for multiple terminal system change-overs. The Demand Division Multiplexer® (DDM) is a front-end and remote concentrator/disburser which can control up to 16 remote video terminals or 16 simplex half or full duplex modems. By employing a small storage (line-by-line) and a scanning "demand" technique, the multiplexer accepts the data, recognizes the end-of-line condition, and re-transmits the inquiry to the computer for processing. Computer Security Systems, Inc., 155 W. 68th St., New York, N.Y. 10023.

Circle Reader Service #277

300 BAUD DATA SET

This unit, designed to operate with teletypes, teleprinters, CRT terminals, and other input/output devices, is fully compatible with the Bell System 101, 103, and 113 series. The 103GM data set consists essentially of two basic parts—the modem and the optional control panel. The data set (with loop-around test function) is available for operation in either the originate, manual answer, and automatic answer modes. Design Elements, Inc., 1356 Norton Ave., Columbus, O. 43212.

Circle Reader Service #278

TOUCH-TONE® ENCODER

Applications for this encoder include remote digital controls, digital data transmission and, in conjunction with base station equipment, a mobile link to telephone landlines. This touch-tone® encoder also includes an automatic switching matrix and a built-in transmission indicator lamp. The TCI-200 is available in a variety of configurations, with 12 or 16 tones, in 115 V ac and 12 V dc models. Integrated Systems Technology, Box 2585, 2701 National Dr., Garland, Tex. 75041.

Circle Reader Service #279

VIDEO TERMINAL CONTROLLER

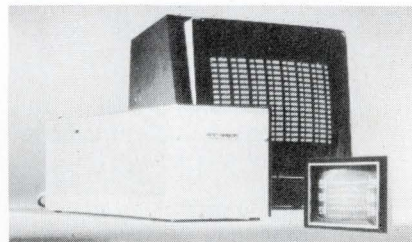

The video terminal controller provides low cost, soundless alphanumeric display at asynchronous data rates to 1200 char./s, plus full graphics, in black/white or color. The Model 206 is capable of driving multiple displays, either conventional TV sets or std. 525-line video monitors. Standard units provide serial or parallel RO33- or KSR33-equivalent interface with RS232C, TTL, or current loop compatibility. \$945 (single quan.) 15 day delivery. Ann Arbor Terminals, Inc., 6107 Jackson Rd., Ann Arbor, Mich. 48103.

Circle Reader Service #280

PDP-11 TAPE CONTROLLER

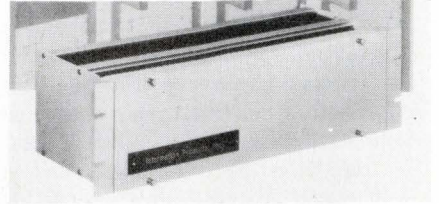

This is available as a complete tape memory subsystem or as a controller interface. The *data path* Series 1X15 controller provides complete control of data flow between the PDP-11 and up to four transports (7- or 9-track compatible). It controls generation of tape format for compatible information interchange. \$3040 (single). Stock delivery. Information Products, Inc., 4202 Directors Row, Houston, Tex. 77018.

Circle Reader Service #281

NEW MODEM

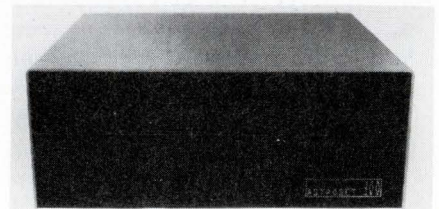

When operated on dedicated or switched C4 lines, C1 and C2 conditioned lines or Type 3002 unconditioned circuits, the modem delivers 4800 b/s. Three plug-in equalizers are available to match Series 348 to almost all telephone circuits. \$5,000. Astrocom Corp., 15012 Minnetonka Industrial Rd., Minnetonka, Minn. 55343.

Circle Reader Service #282

ASYNC CONTROLLERS

These two asynchronous controllers service eight and four, full-duplex channels respectively. Each model (Model 2612 and 2612-1) can be installed in a single I/O card slot. Connectors on the interface board accommodate cables to modems and to terminals with either the RS232C Standard or 20-mA current-loop interface. Prices \$200/channel for the 2612 and \$250/channel for the 2612-1. Microdata Corp., 644 E. Young St., Santa Ana, Calif. 92705.

Circle Reader Service #283

**It's downright humiliating!
Any field return is one too many!**

**Horace, you're never satisfied.
We may have just set the industry's
lowest return record!**

**I hate these impassioned
technical discussions.**

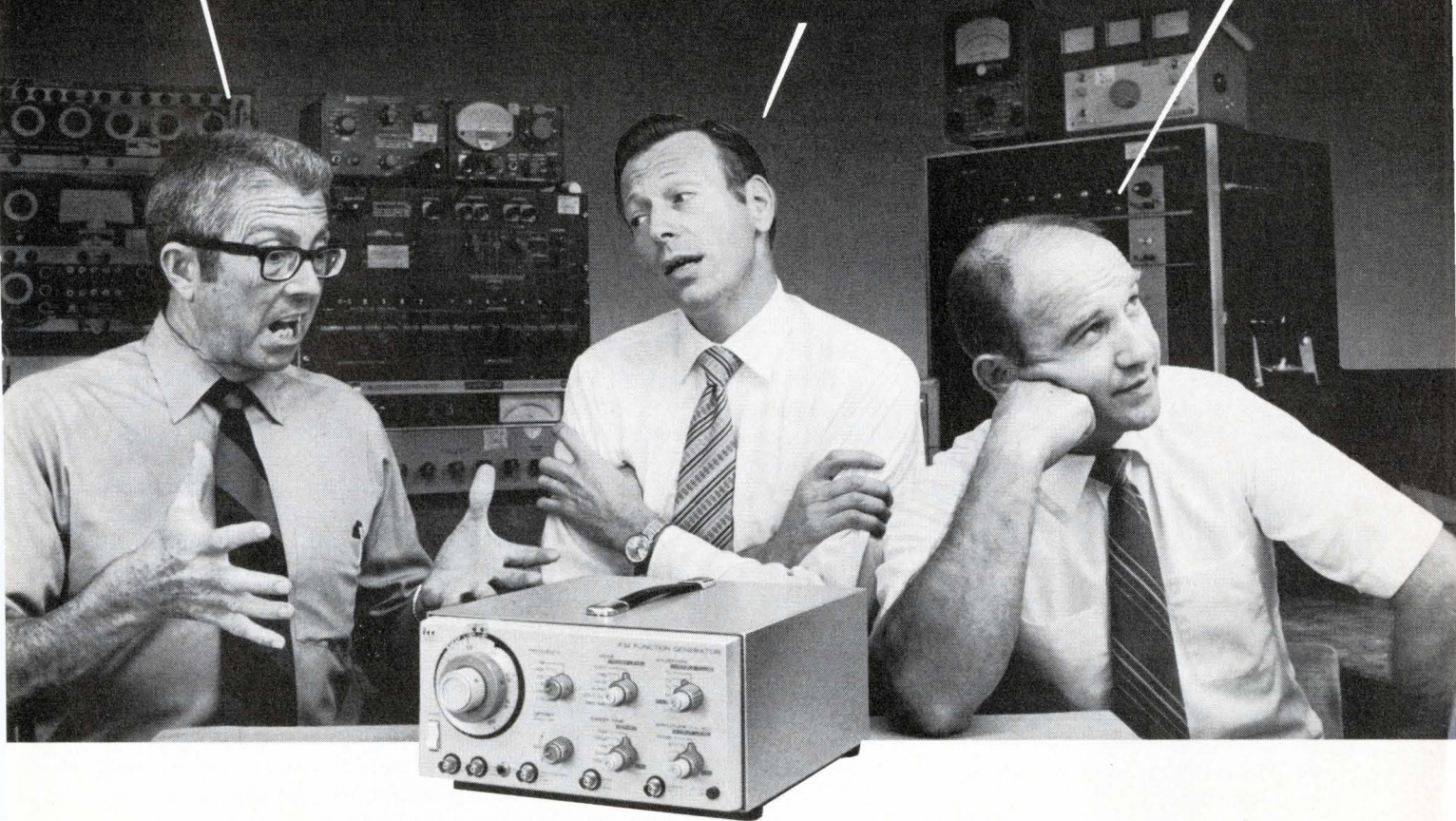

Even a 3.1% Function Generator return rate agitates Horace. IEC has trained him well.

It's an unwritten business rule that you don't discuss your problems with the outside world, but we're breaking tradition because we feel our F34 returns are worth talking about. This extremely low warranty repair record was established during the **first year** of production, even though industry statistics demonstrate that failure percentages are highest during the initial stage of product life. According to electronics manufacturers' trade association data, standard warranty returns can range from 10% for DVM's and oscilloscopes, to as much as 300% for some temperamental instruments. This is why we feel that our F34's current return rate of 3.1% is a real achievement.

Much of the credit for this reliable new function generator must go to IEC's Corporate Cal Lab, one of the few testing facilities with analysis standards one generation away from the National Bureau of Standards. The F-34 underwent the same kind of computerized error-analysis and evaluation testing that our Metrology staff developed for Polaris/Poseidon and other government programs.

With our stringent Quality Control system, we make sure that our test instruments measure up to performance standards, because we're vitally aware that downtime is a significant factor in test instrument selection. Over 300 generators were

shipped before one was ever returned, and to date, 96.9% have **never** required warranty maintenance. But because our QC people, like Horace, worry about that 3.1%, we'll try to do even **better**.

If you would like a perfectionist like Horace on your team, specify the F-34. It generates reliable 0.03Hz - 3MHz waveforms, with Variable Width Pulse for pulse generator applications, and an outstanding combination of operating features for \$495... In a hurry to match your requirements? Call John Norburg (collect) 714/772-2811.

Circle Reader Service #29

SEE IEC AT WESCON, BOOTH 2907 - TELL 'EM HORACE SENT YOU

**INTERSTATE
ELECTRONICS
CORPORATION**
Subsidiary of A-T-O Inc.

Dept. 7000, Box 3117, Anaheim, Calif. 92803.
TWX 714-776-0280 TELEX 655443 & 655419

Miles of microwaves . . . Having completed design and manufacturing work on the world's largest microwave system for distribution and control of electric power, Collins Radio is starting work on a \$10 million, 1,817 mile system for the Burlington Northern Railroad. The 1,978 mile power control system connects 73 stations in south-central Brazil, and establishes Collins as the major supplier for such equipment in South America. The 93-station railroad system will cross eight states between Spokane and Chicago and is scheduled for mid-1974 completion.

Printing on the move . . . A recent decision by the Federal Communications Commission promises large sales for mobile teleprinters. Before the FCC decision, the use of the printers was mostly limited to police and fire departments; now almost all users of mobile radios may add mobile teleprinters to their gear. Attracted by a Xerox Corp. executive's prediction of a five-fold sales increase, Xerox, Motorola, and IBM are pushing their sales' efforts, especially to utilities.

What the customer will want from future telecommunications services . . . What will customers want? Here's Charles Terreault's answer, from Bell-Northern Research's magazine, *Telesis*.

1. Manual and/or automatic addressing by the calling user (calling user to access required distant terminal by manual addressing means such as dialing, or by programmed, automatic means).
2. Abbreviated addressing (speed calling).
3. Broadcast transmission (conference calling and message delivery to several users).
4. Automatic establishment of communication path between users, once called user is free.
5. Controlled access and privacy during conversation (access barred to all but those who purchase a particular service; for example, data bank utilization and provision of individual access to private information).
6. Conversion of messages from one transmission speed to another for machine-to-machine information transfer.
7. Conversion of messages from one code to another for machine-to-machine information transfer.
8. Information transfer to distant user at specific time under option of sender store and forward service.
9. Terminal compatibility check between calling user and called user.
10. Alternative audio and machine-to-machine communication.
11. Automatic answer, disconnect, and calling for machine-to-machine communication, and recording of audio messages.
12. Automatic establishment of conference channels.
13. Add on (three-way) calling.
14. Establishment of conference channels under manual control, but without operator assistance.
15. Provision for hot-line facilities; no dialing, and immediate connection to called line.
16. Call transfer, instituted by called party.

Doubled data . . . By 1980, the Bell system expects to devote more than 12% of their network time to data communications, according to Theodore L. Simis, newly appointed assistant vice president for computer communications and data service. This figure compares with almost 5% for data at the present. "This is a highly competitive arena, especially in the area of station sets and terminal equipment," says Simis of the data communications field. Interestingly, 73% of all data customers are still using speeds of 300 b/s, and all but 0.2% are in the low- and medium-speed categories, according to Simis.

RCA, the specialized common carrier . . . Despite complaints from Microwave Communications Inc. (MCI), a voice and data common carrier, RCA will offer a network service, based on the joint use principle. Service (4-kHz, AT&T voice channel) will be offered to subscribers in some 35 cities. These subscribers will get cheaper rates through RCA taking advantage of the joint use tariff than as individual users of AT&T service. (How it works: 75 subscribers can get on one line at only double the cost charged a single subscriber.) Approximately \$2 million worth of multiplexing equipment will be needed.

Marketing, not technology, will unlock the data entry market . . . According to Quantum Science Corp., Palo Alto, Calif., you can't depend on any major technological advances in the computer systems' data entry market in the next five years. Because of this, the Quantum Science report, "Data Entry—Keying for Profit," insists that buyers will be reluctant to get new equipment. Conclusion: sales will come from marketing effort, not innovations.

New appointment . . . Dr. John M. Richardson was named acting director of the Office of Telecommunications of the Department of Commerce. In this post, he succeeds Dr. Armig G. Kandoian, who will serve as a consultant on telecommunications program development to James H. Wakelin, Jr., assistant secretary of commerce for science and technology. Richardson, who played a key role in the organization of the Office of Telecommunications in 1970, is U.S. representative to the panel on data communications of the Organization for Economic Cooperation and Development.

Bits and bytes . . . The annual **Digitronics Users Association (DUA)** conference will be held Oct. 16-17 at the Royal Orleans Hotel, New Orleans. Among the topics to be discussed are the latest developments in telephone equipment; minicomputers in large systems; the impact of data automation on levels of business organizations; and the unresolved problems of regulation of common carriers, special carriers, and interconnect. Some of the speakers will be Francis Riordan, president of NARUC (national Association of Regulatory Utility Commissioners), and Bernard Strassburg of the FCC. For information, write Executive Secretary, DUA, Box 33, Southboro, Mass. 01772 or call (617) 481-2500.

UP-FRONT SIMPLICITY: LEVER-LITE III

Rugged modular construction gives you a reliable lighted lever switch that provides front-of-panel convenience on the assembly line or in the field.

Our new "Lever-Lite" III switches were designed to simplify installation and servicing of lighted lever switches on computers, telecommunications systems, industrial control equipment, intercoms, broadcast consoles and scientific or test instruments of all kinds.

SIMPLE to mount and terminate. "Lever-Lite" III switches are installed from the front. In a single hole. The lever assembly (lever-actuator, lamp and socket, and color filters) simply

slips into its housing. An escutcheon that "snaps-in" place secures the lever assembly and "trims" the mounted switch. Switching and lamp terminals are solder lug type but also accept standard quick connect-disconnect receptacles.

SIMPLE to relamp. Front-of-panel relamping or changing of color filters can be done easily by removing the escutcheon and lever assembly with your fingertips.

SIMPLE to find what you need. "Lever-Lite" III switches are available in 2- and 3-position types. With locking, non-locking and talk-listen functions. You can order multi-color (different colors in each position), mono-color (one color in all positions) or non-illuminated "Lever-Lite" III switches. And they can be specified with SPST to 8PDT switching.

SIMPLE to get. Contact your local Switchcraft distributor, sales representative, or write us direct. Switchcraft, Inc., 5539 N. Elston Avenue, Chicago, Illinois 60630.

SWITCHCRAFT
INC.

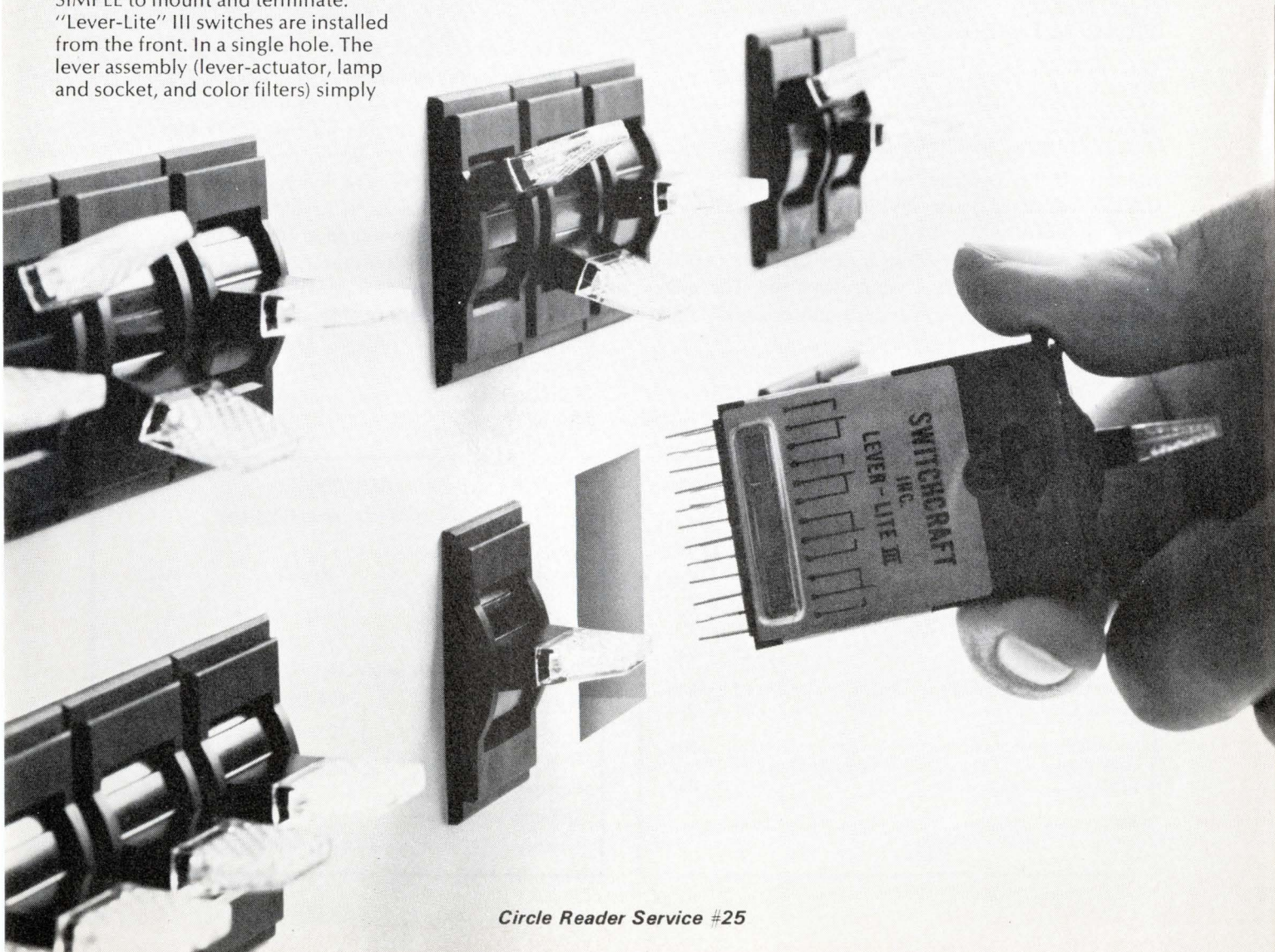

Build your own 4½ digit DVM for \$141

Take a hybrid A/D converter, add some logic and readouts, and start measuring voltage.

Stephen A. Thompson, Western Editor

One approach to the problem of the analog front end in a DVM is to use a hybrid circuit. Ricky Martin, Chief Engineer for Integrated Conversion Technology (ICT), contributed this do-it-yourself, 4½ digit panel meter design. With ICT's ADC 2001 hybrid converter in a 14-pin DIP, Mostek's 5005P counter/decoder, and Monsanto's MAN-4 LED displays, you can construct your own DVM. The meter fits onto a 2½ in. x 3 in. board and assembly takes less than a day.

The table lists the parts with single quantity prices. Analyzing the list, it's easy to see why DVM is basically a three component unit. Over 80% of the

cost is concentrated among three parts: the converter, logic chip, and display.

Though other logic forms would do, Martin chose CMOS and MOS LSI circuits for low power battery operation. The assembly draws less than ¼ W, exclusive of the display. The meter accepts a unipolar input from 20 mV to 20 V. A single zero drift adjustment takes care of all temperature compensation.

The second table, summarizes the ADC 2001 converter specs. It contains a voltage regulator, solid state switch, comparator, integrator, logic level shifter, and reference voltage. The converter outputs ±15 V regulated from a ±20 V unregulated supply. Inputs can be multiplexed, and the conversion rate is 20 ms.

Parts List (Costs are for single quantities)				
Part	Function	Vendor	Cost(\$)	Inquiry
CD4001AE	Quad. 2-input NOR gate	RCA	1.77	245
CD4011AE	Quad. 2-input NAND gate	RCA	1.77	246
CA3081	Common anode or cathode driver	RCA	3.12	247
CA3082	7-segment multiplexed driver	RCA	3.12	248
CD4013AE	Dual D flip-flop	RCA	3.60	249
CD4022AE	Divide by 8 counter	RCA	7.65	250
MK5005P	Counter/decoder	Mostek	30.00	251
MAN-4 (5)	LED display	Monsanto	36.25	252
ADC2001	Analog front end	ICT	49.00	253
Misc.	Resistors, capacitors, etc.	-----	5.00	
TOTAL COST			\$141.28	

ADC 2001 A/D converter specifications		
Spec	Typical	Max.
Input bias current	1 nA	15 nA
Input offset voltage	0.5 mV	1.5 mV
Av. temp. coeff. of offset V.	1.5 μV/°C	4.5 μV/°C
CMRR & SVRR	110 dB	80 dB (Min.)
Reference voltage	10.0 V ±2%	
Switch on resistance	40 Ω	100 Ω
dc current drain		+3 to -6 mA
Operating temperature		0-70°C
Package	14 pin DIP	

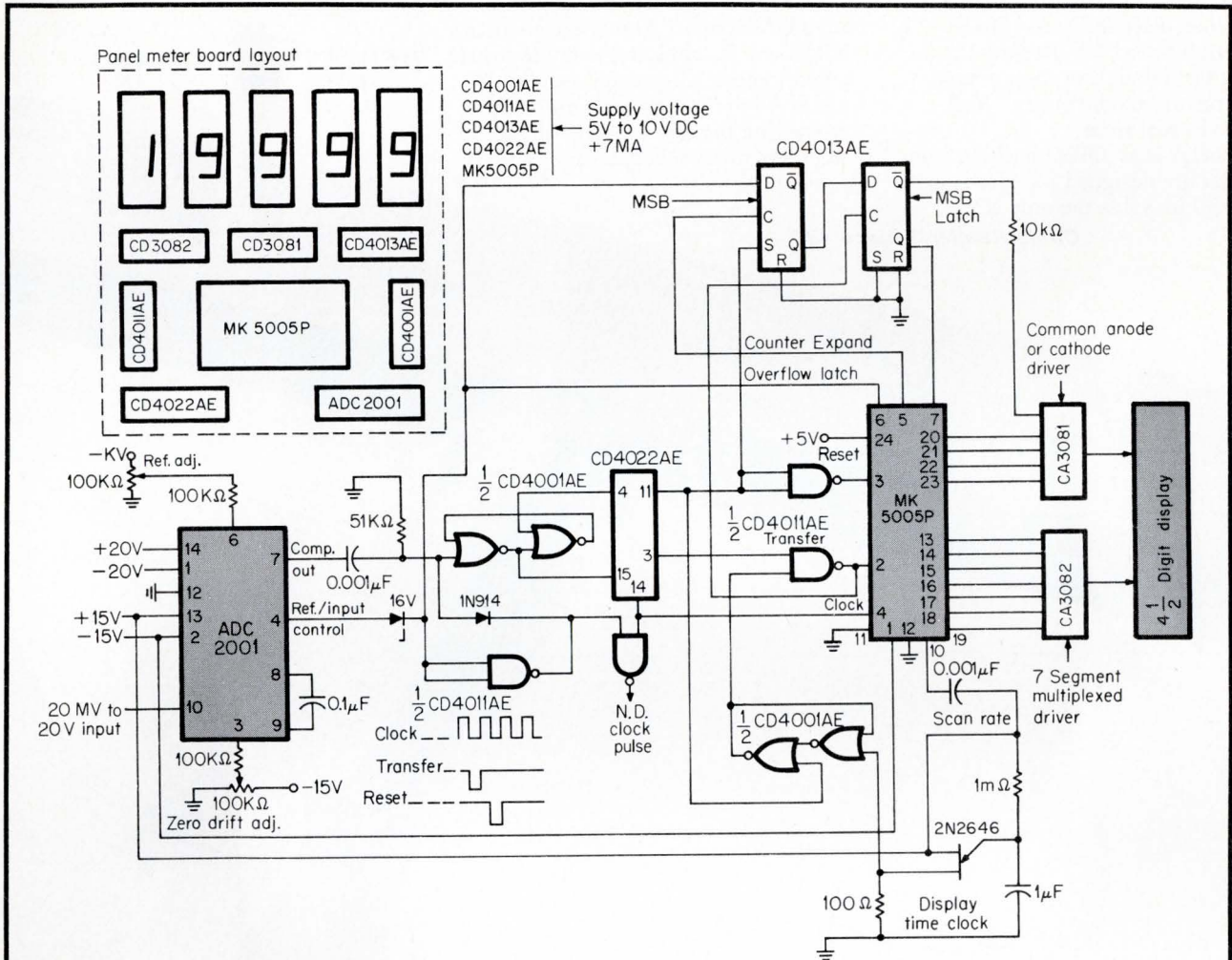

Engineering notes for the 4 1/2-digit DVM

Use a 1- μ F, 15-V tantalum capacitor across the +15-V and -15-V outputs.
 For best linearity, use a low dielectric hysteresis capacitor as the integrating capacitor and an input voltage resistance of 50 Ω or less.
 The 30-V peak pulse comparator output must couple in +5 V logic through a 0.001 μ F capacitor.
 The ref./input control must couple through a 16-V, 10%, 1/4-W, general purpose diode.
 For a 1:1 scale factor, apply 10 V to the input, connect the ref. Adjust pot to the -15-V supply, and trim until

the readout or binary output is equivalent to 10,000 V.
 A simple method of obtaining a near zero temperature coefficient is suggested by the fact that all hybrid components are on the same substrate and will warm to about the same temperature. Connect the zero adjust pot to the -15-V supply and warm the IC with a soldering iron to a temperature just uncomfortable to the touch (about 200°F). Adjust the pot to alter the tempco of the internal reference positively or negatively, as indicated.
 For automatic binary conversion, attach the N.D. clock pulse to a binary counter.

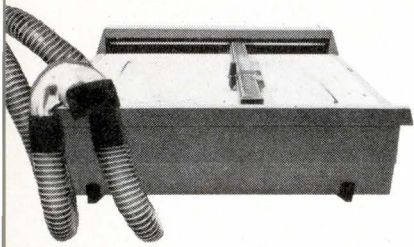

One OEM xy recorder works at breathtaking speed.

Inhale . . . exhale. It takes about 4.5 seconds. Just about any XY recorder could chart the volume of air in a human breath—if doctors were willing to settle for a flow loop the size of a half dollar. But they won't. In a breath analyzer, a small flow loop means imprecise, hard-to-read measurements. And Hewlett-Packard's new Model 7041A High Speed XY Recorder is the only unit fast enough to chart a large, accurate picture of the lung's "vital capacity." In real time.

The 7041A is an OEM machine from the ground up, designed for speeds in excess of 30 in/s. It's the only XY

recorder built on a one piece, die-cast aluminum mainframe. And you can choose from nearly 40 independent options to customize the recorder to your special application (standard or high speed). You'll get just what you want . . . and only what you want.

Our standard features make sense in any OEM system: Autogrip electrostatic holddown, IC circuitry, long-life hybrid potentiometer, disposable pens and more. All the things we learned while pioneering the development of XY recorders for two decades.

H-P's new cast aluminum XY recorder: high accuracy at breathtaking speed. Make your own diagnosis, get specifications and discount data from Hewlett-Packard, 16399 West Bernardo Drive, San Diego, California 92127. Europe: 1217 Meyrin-Geneva, Switzerland.

112-01

HEWLETT  PACKARD

Circle Reader Service #30

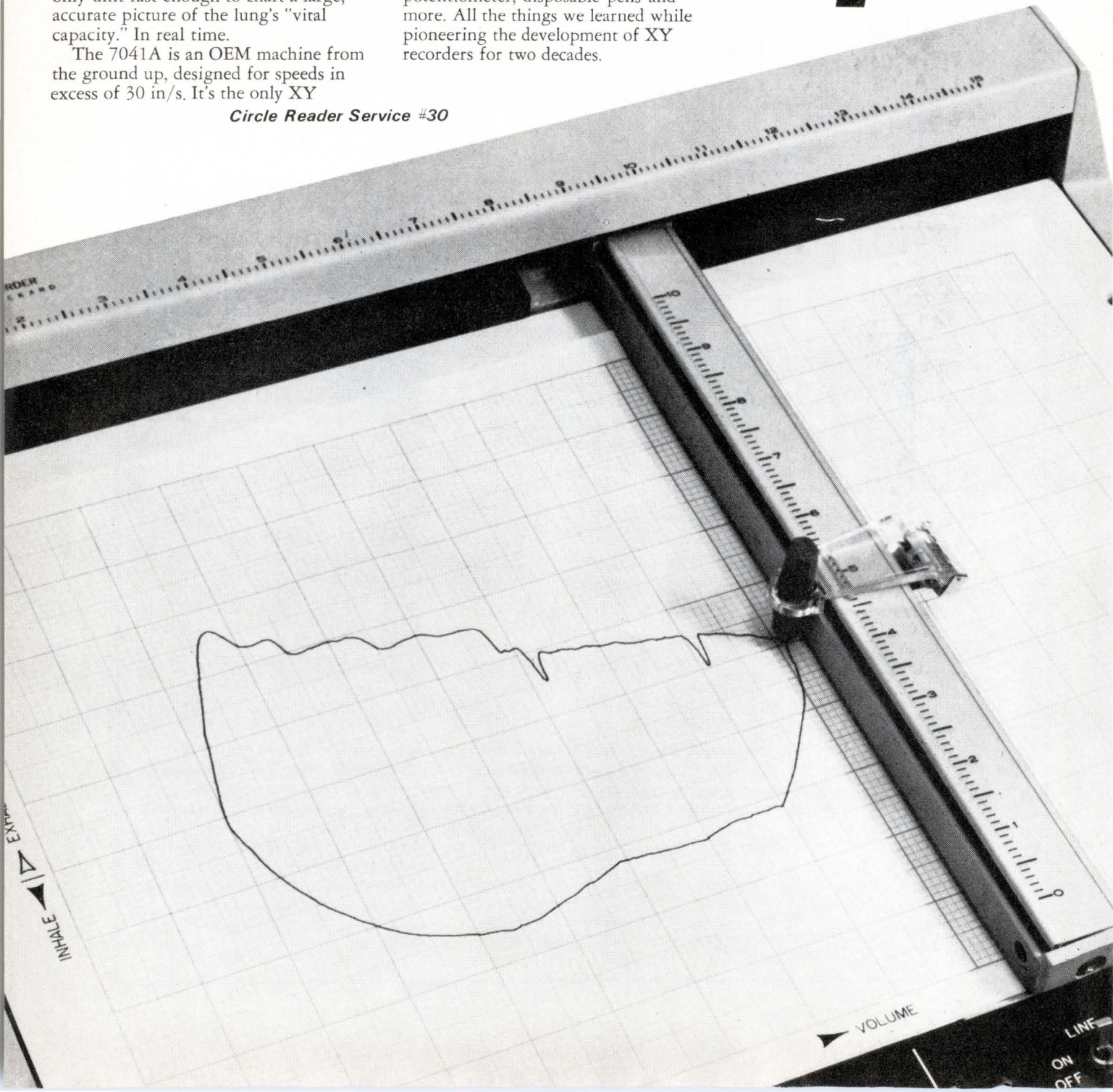

SYSTEM PRODUCTS

THERMAL PRINTHEADS AND PRINTERS

Here are two thermal printheads and two printers with associated driver circuitry. The EPN2200 uses 35 elements in a 7 x 5 matrix to form 30 characters/s. The EPN2201 printer includes the EPN2200 printhead and five SN2111N drivers. The SN21111 is a 7-channel buffer amplifier for interfacing between an MOS char. generator and the printhead. The EPN2300 printhead has a 5 x 4 matrix and prints 12 char./s. The EPN2301 printer includes the EPN2300, one SN21485N row driver and one SN21485N column driver for interfacing between a MOS character generator and the thermal printhead. Texas Instruments Incorporated, Inquiry Answering Service, Box 5012, M/S 308, Dallas, Tex. 75222.

Circle Reader Service #284

300 BAUD DATA SETS

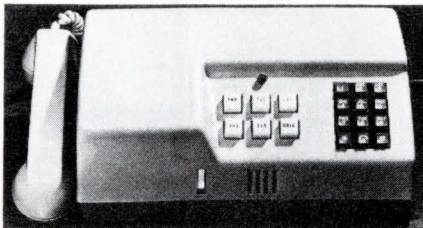

The 101CTH direct access data coupler contains the significant functions and features found in the Bell System 101C units. Front panel contains the operators pushbuttons and indicator lights together with a rotary type dial or optional touchtone pad for originating data or voice calls. A loud speaker with its volume control allows the operator to listen to the various call progress tones (ring, busy number, busy circuit, etc.) during pre-data transmission. A disconnect feature automatically puts the unit "on-hook" upon loss of carrier. The data then reverts back to the automatic answer status to accept incoming calls. Contact George Gerhard, Design Elements, Inc., 1356 Norton Ave., Columbus, Ohio 43212.

Circle Reader Service #285

EIGHT CMOS DEVICES

National Semiconductor is introducing eight CMOS product types which are pin for pin replacements for RCA's 4000A series. In addition, they will shortly announce a proprietary line of CMOS types which will be pin for pin compatible with existing 7400 TTL devices. The new second source types operate from a 3 to 15 V supply, have a power dissipation of 10 nW typical, and have a typical noise immunity of 0.45 V_{dd} . National Semiconductor Corp., 2900 Semiconductor Dr., Santa Clara, Calif. 95051.

Circle Reader Service #286

PDP-14 COMPATIBLE ROM

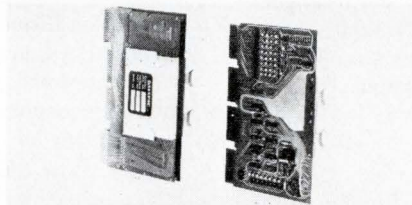

Aimed at the industrial control market, this 1024 x 12-bit ROM is electrically and mechanically compatible with the PDP-14 programmable controller. Operating from a single +5.0 V power supply, it provides system access times of 150 ns and cycle times of 480 ns. All data output lines are buffered latches to provide improved drive characteristics and system reliability. Data-pac, Inc., 3180 Redhill Ave., Costa Mesa, Calif. 92626.

Circle Reader Service #287

LOW-POWER ARITH. ARRAY

This new COS/MOS device, designated CD4057 (preliminary), gives you the capability to construct an arithmetic system of virtually any size by wiring together a number of arrays. The device provides 4-bit arithmetic operations, time sharing of data terminals, and full functional decoding for all control lines. Applications include parallel arithmetic units, process controllers, remote data sets and graphic display terminals. RCA Solid State Div., Box 3200, Somerville, N.J. 08876.

Circle Reader Service #288

SYNCHRONOUS CMOS UP-COUNTERS

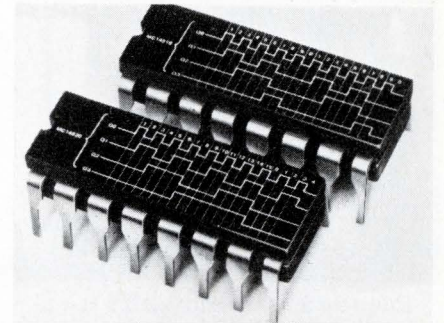

The MC14518 and MC14520 are for counting applications at rates up to 6 MHz. The 518 provides a dual, BCD up-counting function while the 520 offers a dual, binary up-counting capability. Both up-counters consist of two, identical, independent 4-stage counters. Technical Information Ctr., Motorola Inc., Semiconductor Products Div., Box 20924, Phoenix, Ariz. 85036.

Circle Reader Service #289

2048-BIT MOS RAM

The AMS 6003 offers 360 ns max. access time and 595 ns max. cycle time. It features TTL-compatible inputs, and incorporates address registers, chip-select registers and data output latches within the chip for easy memory-system implementation. \$20.48 in quan. of 250. Advanced Memory Systems, Inc., 1276 Hammerwood Ave., Sunnyvale, Calif. 94086.

Circle Reader Service #290

NEW ASSEMBLER/EDITOR

A new conversational assembler that also provides extensive on-line editing and updating capabilities is now available to users of 16-bit Naked Mini and Alpha 16 minicomputers, without charge. Called OMEGA, the new computer automation software package enables paper tape users to perform both editing and program assembly functions in core memory, eliminating the treadmill chore of re-punching tapes to eliminate all errors prior to final program assembly. Computer Automation, Inc., 895 W. 16th St., Newport Beach, Calif.

Circle Reader Service #291

MICRO COMPUTER PROTOTYPING SYSTEMS

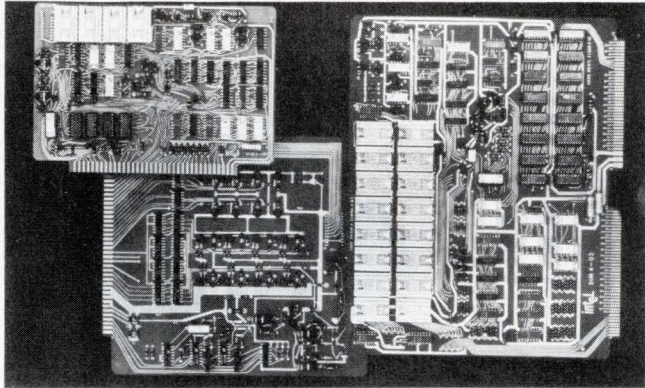

These three PC boards enable you to program Intel's 2048-bit electrically-programmed PROMs and to assembly prototypes of complete micro computer systems built with the MCS™ -4 Micro Computer Set. Each SIM board becomes a complete micro computer prototype, requiring only a power supply to be fully operational. Built into each are the integrated CPU, a 2-phase clock generator, a test and reset generator, an interface for an ASR-33 teletypewriter, and sockets for PROMs and RAMs. Micro Computer Systems Group, Intel Corp., 3065 Bowers Ave., Santa Clara, Calif. 95051.

Circle Reader Service #292

SINGLE DENSITY DISC DRIVE

The Model 741 is a single density disc drive similar to the IBM 2314/2319 drive units. When used with a Model 844 Universal Controller, the new drive can be interfaced with the central processing unit of any computer manufacturer. It is available in single spindle or dual spindle cabinets, giving each cabinet a data storage capacity of either 29 or 58 Mbytes. Each 741 drive records at 2200 b/in. density and has access times of 7 ms minimum and 29 ms average. Peripherals General, Inc., Cherry Hill Industrial Park, Cherry Hill, N.J.,

Circle Reader Service #293

FOUR FUNCTIONS PLUS MEMORY

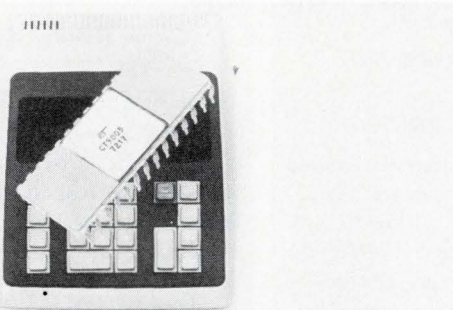

The CT5005 offers not only the standard four functions (add, subtract, multiply, divide) but memory as well on a single chip. Designed for a 12-digit display calculator, the CT5005 is a p-channel MOS chip with two operation registers as well as the memory. Packaging is a 28-pin DIP. Price ranges from \$23 to \$15 depending on quantity; delivery, 30 days. Cal-Tex, 3090 Alfred St., Santa Clara, Calif. 95050.

Circle Reader Service #294

WIDEBAND HYBRID CATV MODULES

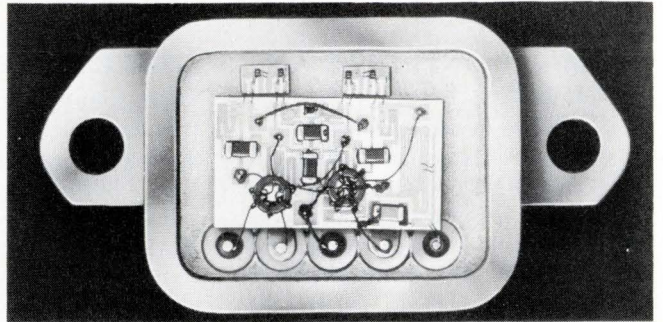

The type MHW560 input module provides 16 dB of power gain with a bandwidth of 40-300 MHz (within ± 0.3 dB). It is intended for use as a low-noise preamplifier for either trunk-line or line-extender applications. The MHW561 provides an additional 15 dB gain and is intended as the output function in a line extender. Cross-modulation distortion is < 57 dB at 47 dB mV output (21 channels). The third module type MHW562 is intended for use as the output amplifier in a trunk-line amplifier. Again 15 dB gain is provided with cross-modulation distortion < 60 dB (+50 dB mV output and 21 channels). All three units are designed to operate with a 24-V dc power supply. Technical Information Center, Motorola Inc., Semiconductor Products Div., P.O. Box 20924, Phoenix, Ariz., 85936.

Circle Reader Service #295

DIGITAL FILTER



The Model 4136 is a single channel digital filter especially suited as a prefilter in digital signal processing applications. For example, in spectrum analysis via the Fast Fourier Transform (FFT), the signal may be sampled at higher than the desired Nyquist rate and then sharply bandlimited to allow a reduction in the sampling rate to the Nyquist rate. This minimizes the required speed of the FFT system and/or maximizes its capability. All classical filter types can be programmed via twelve 16-bit filter coefficients, including Butterworth, Chebyshev, Bessel, and Cauer (elliptic). The digital signal input and output also provide up to 16 bits; while internal computation is carried out with 24-bit accuracy. Internal 12-bit A/D and D/A converters are available as options. Model 4136 is priced at \$8,500. With internal 12-bit A/D and D/A converters, the price is \$11,500. Rockland Systems Corp., 230 W. Nyack Road, West Nyack, N.Y., 10994.

Circle Reader Service #296

COMPUTER PRINTER

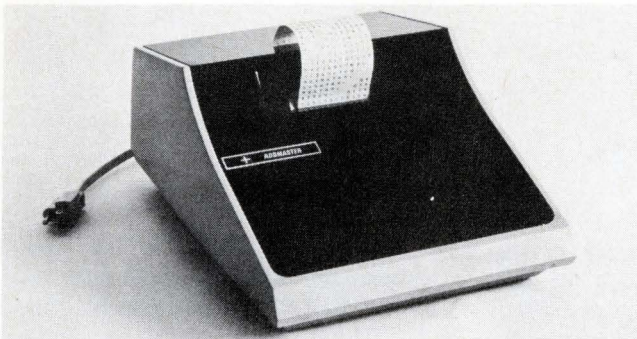

The printer accepts serial by character or full parallel BCD data inputs and is TTL compatible. It has a print speed of up to 3 lines (36 characters)/s, and a 12-column capacity, using numerals or limited alpha characters. Twelve characters are available in each column. Addmaster Corp., 416 Junipero Serra Dr., San Gabriel, Calif. 91776.

Circle Reader Service #297

MOS FIRST-IN FIRST-OUT MEMORY

This device offers a solution to interfacing digital systems that have different data rates. The 3341 is organized 4 bits wide x 64 bits long. When a word is entered, it propagates to the farthest downstream unfilled location, with no clocking required. If a word is shifted out, all other words move down automatically to the unfilled locations. Thus the inputs and outputs operate completely independently (without common clocking), translating two dissimilar data rates simultaneously. Prices are \$22 (100-999 quan.) for the 1 MHz version and \$15.60 for the 0.6 MHz version. Fairchild, Semiconductor Components Group, 464 Ellis St., Mountain View, Calif. 94040.

Circle Reader Service #298

PROGRAMMABLE COAXIAL ATTENUATOR

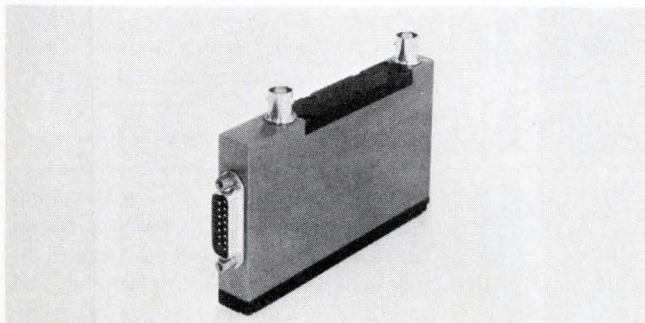

This programmable coaxial attenuator can be remotely controlled by computer or other means. The module accepts a 6-bit parallel binary input which switches the attenuation over a range of 0 to 63 dB in 1 dB steps. The frequency range is dc through 100 MHz, useable to 300 MHz and the unit is available in 50 or 75 Ω versions with a maximum current rating of 90 mA. Matrix Systems Corp., 20426 Corisco St., Chatsworth, Calif., 91311.

Circle Reader Service #299

looking for a....

LOW COST HIGH QUALITY POPULAR SIZE

....ceramic capacitor?

Well, look toward USCC/Centralab.

Our Mono-Kap™, a radial lead, epoxy coated monolithic ceramic capacitor could be the answer. They're available in six sizes from .100 x .100 to .500 x .500 in NPO, W5R, Z5U and Y5V dielectrics. Capacitance values range from 4.7pF to 10Mfd in 50, 100 and 200 VDC ratings.

USCC/Centralab has developed highly automated assembly techniques for Mono-Kap and our other ceramic capacitor products—from raw materials to chip capacitors to leaded capacitors with no sacrifice to quality. All this makes possible the fastest delivery in the industry on the wide variety of USCC components. Ask us, we'll give you our best.



For FREE Mono-Kap evaluation samples, write on company letterhead to USCC/Centralab, 2151 N. Lincoln Street, Burbank, California 91504. For complete technical data on Mono-Kap, and a FREE copy of our Ceramic Capacitor Catalog, circle the information retrieval number below.

USCC

U. S. CAPACITOR
CORPORATION



CENTRALAB
Electronics Division • GLOBE-UNION INC.

MICROWAVE AMPLIFIERS

The WJ-5126 series (8 to 12.4 GHz) and the WJ-5203 series (12.4 to 18 GHz), provide up to 60 dB linear gain and 100 mW power output in selected bandwidths of their frequency range. Watkins-Johnson Co., 3333 Hillview Ave., Stanford Industrial Pk., Palo Alto, Calif. 94304.

Circle Reader Service #300

ULTRA-PRECISE INST. AMP.

Model 8300XWB-A features 0.01% gain accuracy, 0.005% gain linearity, variable gain to 2500X, bandwidth selection between 10 Hz and 100 kHz, low drift, and high common mode rejection at pk levels up to 350 V. In addition, it has a slewing rate in excess of 3 V/ μ s; the output settles within 30 μ s to $\pm 0.01%$ of final value. \$645. Preston Scientific, Inc., 805 E. Cerritos Ave., Anaheim, Calif. 92805.

Circle Reader Service #301

FLEX. TRANSMISSION LINE

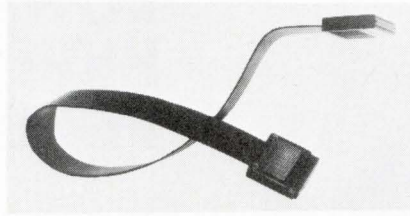

The Series 202 flexible cable assembly was designed specifically for interconnecting peripheral equipment with the SLT pin field in IBM 360 computers. Made of a polyethylene core and flame retardant vinyl jacket, the cable has 23 round signal wires and 24 rectangular ground conductors. Grounds can be commoned to any number of pin positions. When compared to conventional flat cable, "Black Magic" cable offers as much as five times lower far end cross-talk. Ansley Electronics Corp., Old Easton Rd., Doylestown, Pa.

Circle Reader Service #302

PROM USES SILICON LINKS

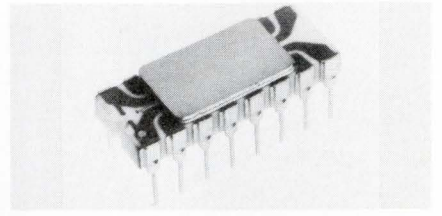

Designated the 3601, this new PROM is programmed by breaking fusible links of silicon inbedded in the matrix of the chip. The silicon-fuse PROM is easier to program than the blown-junction type because the width and risetime of the programming pulse are not critical. The silicon fuse separates cleanly and cannot cure or re-link. Using an automatic programmer, typical programming time for each 1024-bit device is one second. Intel Corp., 3065 Bowers Ave., Santa Clara, Calif. 95051.

Circle Reader Service #303

VERSATILE LOGIC MODULES

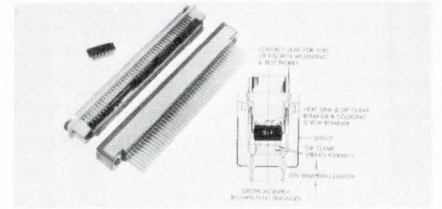

DipStik packages that hold up to five DIPs make up the DipLogic family of: 22 universal modules such as gates, flip-flops, and multivibrators; 10 functional modules including counters, registers, decoders and latches; and custom modules. Finished, tested modules come ready to wire. DipLogic is claimed to be one-half to one-third as expensive as plug-in cards, while making full use of TTL speed. It also competes with sockets-on-a-board approaches in the small quantity and prototype problem areas. Modules provide the package, test points, wire wrap and I/O terminals, and easy discrete component addition. Typical modules costing \$17.36 for 1-9, or \$14.38 for 50-99 are (7404) Hex Inverter, (7400) Quad 2-input, (7410) triple 3-input, or (7420) Dual 4-input positive NAND gates. Stanford Applied Engineering, Advanced Packaging Div., 2165 South Grand Ave., Santa Ana, Calif. 92705.

Circle Reader Service #304

MODEL 6653A

Fastest, most accurate $4\frac{1}{2}$ digit DMM... with true RMS measurement. Features include 1 KHz reading rate, 50 ns sample and hold, ± 1 digit accuracy, 1 μ V resolution, autoranging, remote programming, and photo-coupled output.

MODEL 6753

A proven $5\frac{1}{2}$ digit DMM for lab standard, production test and systems. Features include 100 nV to 1100 VDC, .002% accuracy, true RMS, fully programmable, isolated data output, digital output indication of signal noise content, and repetitive mode.

MODEL 6853

The most complete $5\frac{1}{2}$ digit DMM ever developed features .001% accuracy, 100 nV to 1100 VDC in 6 ranges, 10 μ Ω to 110 M Ω in 9 ranges, AC/AC ratios, DC/DC bipolar ratios, and digital output indication of signal noise content.

For detailed specifications and a demo of these finest quality DMM's, write or phone today: Lear Siegler Inc., Electronic Instrumentation Div., Cimron Instruments, 714 N. Brookhurst St., Anaheim, Ca. 92803. Phone (714) 774-1010.

Cimron
quality
makes the
difference

LEAR SIEGLER, INC.  ELECTRONIC
INSTRUMENTATION
DIVISION
CIMRON
INSTRUMENTS



Circle Reader Service #57

FREE SAMPLES FOR NEW LINE OF LASERS

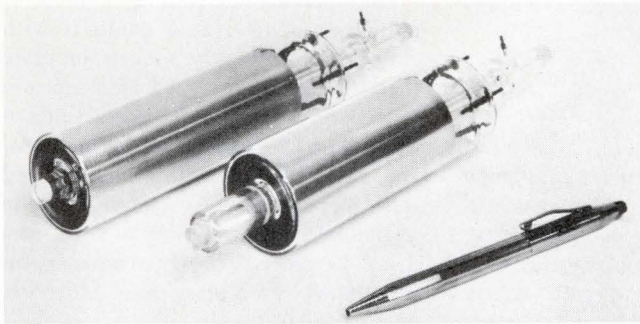

This new line of He-Ne laser plasma tubes is being introduced by offering free samples to qualified original equipment manufacturers. They are the first of a new generation of internal mirror tubes, and are intended for large-quantity OEM users who require a bottle-only laser. Thousand-piece price of the tube is \$79.95, and an 18-mo., no-hour-limit, OEM warranty is offered. Available in 1- and 2-mW versions, with polarization optional, the plasma tubes measure 9 in. in length and feature a proprietary non-hydroscopic mirror sealant for environmental protection under adverse weather conditions. The free sample offer is available to any OEM with a valid requirement for laser tubes. Hughes Electron Dynamics Div., 3100 W. Lomita Blvd., Torrance, Calif. 90509.

Circle Reader Service #305

HEAD PER TRACK DISK

The 914 series of fixed head per track disk cartridge drives have storage capacities ranging from 0.5 to 8 million bits and from 0 to 512 sectors. Rotation speeds of 1800, 2400, and 3600 result in average access times of 17, 12.5, and 8.5 ms respectively. The 914 can be made plug compatible with existing configurations and controllers for the major minicomputers are available. OEM quality pricing is \$1200 to \$2500. Dataflux Corp., 1195 E. Arques Ave., Sunnyvale, Calif., 94086.

Circle Reader Service #306

THERMAL DIGITAL PRINTER

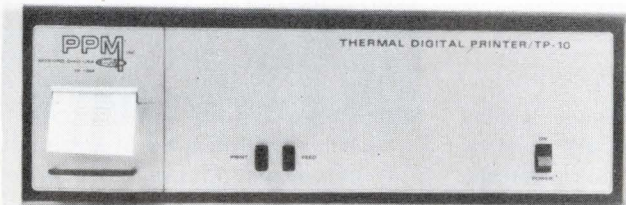

The TP-10 is a complete instrumentation printer with enclosure and carrying handle, while the TP-10M is a plug-in print module for OEM applications. Both units are available with 4, 8 or 12 column capacity. Unused columns (open-circuited data inputs) do not print. Printed characters are numeric, with additional characters, including a floating decimal, available. Print speed is 5 lines/s continuous, or 10 lines/s for bursts of 1000 lines. PPM, Inc., Sub. of Torq Engineered Products, Inc., 32 West Monroe St., Bedford, Ohio,

Circle Reader Service #307

146 MONO-KAP™ Monolithic capacitor values

NOW IMMEDIATELY AVAILABLE FROM YOUR CENTRALAB DISTRIBUTOR

The superior reliability of Centralab MONO-KAP capacitors has already been tested and proven. Now they're available, for the first time, from Centralab Distributors. That means the same tested and proven local service you've come to expect on other Centralab components.

Let your distributor prove his reliability for immediate delivery of the most complete range of radial lead, epoxy-coated monolithic capacitor values in the industry. You can rely upon his complete stock for the prototype or small production quantities you need. Let your distributor prove how fast and how well he can handle your requirements.

Remember, he also stocks a complete line of Centralab ceramic disc capacitors as well as other highly reliable special purpose ceramic capacitors. You can depend on him for feed-thru, variable trimmer and transmitting types plus a wide range of polystyrenes and miniature electrolytics. Check your requirements, then call your Centralab Distributor. He has just the right capacitors you need. Immediately!

Need complete Mono-Kap technical data and the name of your closest distributor? Write Centralab Distributor Products, Dept. MK-1.

DISTRIBUTOR PRODUCTS



CENTRALAB

Electronics Division
GLOBE-UNION INC.

5757 NORTH GREEN BAY AVENUE
MILWAUKEE, WISCONSIN 53201

Circle Reader Service #32

WITH OUR CATALOG
YOU MAY NOT NEED
A CUSTOM

CAPACITOR

AND THE CATALOG
IS YOURS
FOR THE ASKING

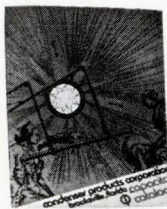

Picture a complete concise composite catalog of over 800 off-the-shelf capacitors, over 1200 variations including some weird and unusual units.

If what you need isn't there, then drop us a line, or give us a call, we'll custom design a capacitor for your circuit, and in most cases there is no charge for customizing. But check the catalog first, what you need may be there and ready for immediate shipment.

**TO GET YOUR CATALOG,
JUST DROP US A LINE.**

**condenser
products
corporation**

Box 997, Brooksville, Florida 33512
Phone (904) 796-3562

Circle Reader Service #53

Att: MANUFACTURERS' REPRESENTATIVES

The Electronic Engineer maintains an extensive file of manufacturers' representatives serving the electronics, instrumentation and equipment industries.

This file is widely used by manufacturers searching for new or additional sales representation. Many profitable contacts have been made through the use of this file.

This Manufacturers' Representatives File is available for use without charge, as a service to the industry.

There are some 4500 representatives in the United States, Canada and overseas presently listed in this file. I invite any representative who wants to be included in this listing to drop me a note. If you are not now listed, I'll mail you an information form. There is no charge for the listing.

BERNARD M. GITTELMAN
Publisher

One Decker Square
Bala Cynwyd, Pa. 19004

SUBSYSTEM PRODUCTS

THIN THUMBWHEEL SWITCH

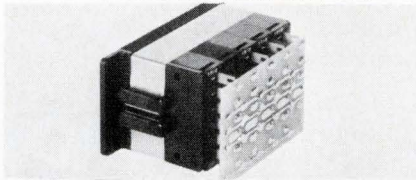

The 1976 Series switches are only 0.350 in. wide with 0.090 in. notched terminals for mounting on 1/16 in. PC mother boards or 0.160 in. notched terminals for 1/8 in. boards. PC board mounting provides a compact, low cost, reliable method of interconnection and component mounting. Four standard mother boards are available, including boards with diode mounting provisions, bussing, and resistor decade interconnections. Electronic Engineering Co., 1441 E. Chestnut Ave., Santa Ana, Calif. 92701. (714) 547-5651.

Circle Reader Service #308

R/O TURNS ON FASTER

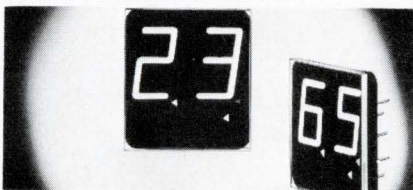

Four gas discharge numeric displays with "keep alive" cathodes extend Sperry's SP-730 line. The extra cathode is an internal ion source that aids turn-on in multiplex, zero blanking, and dark environment applications. All characters are 0.33 in. high with a 0.375 in. centerline spacing, in 1, 1 1/2, 2, and 2 1/2 digit models. Prices \$2.30 ea. (5000 digits); \$1.00 (large OEMs). Sperry, 350 N. Hayden Rd., Scottsdale, Ariz. 85257.

Circle Reader Service #309

OP-AMP POWER SUPPLIES

The D Series of dual output power supplies come with outputs of ± 5 , ± 12 , and ± 15 V, and current ratings from 400 mA to 8.5 A. New low profile models 1.68 in. high and delivering currents to 1 A are available for limited space applications. Line and load regulation are $\pm 0.1\%$. Provision for remote sensing is a std. feature. All models are housed in extruded aluminum cases. Prices from \$85 to \$299 ea.; delivery 3 days ARO. Contact Thomas E. Skopal, Acopian Corp., Easton, Pa. 18042.

Circle Reader Service #310

A LINE OF IC SOCKETS

An expanded line features a choice of plated or bonded gold contacts with closed- or open-entry sockets in more than 200 variations. Clad contacts use a stripe of gold where the contact and IC leads mate. All sockets are for high density packaging of dual-in-line ICs and other devices in DIP packages. They're available in a wide variety of sizes from 8 to 40 pin. Texas Instruments Incorporated, 34 Forest St., Attleboro, Mass. 02703.

Circle Reader Service #311

20 AMP TRANSISTORS



Power Darlington transistors now include a 20 A npn series. U2T501/U2T601 series offers high current gain, up to 2000 min. at 10 A and voltage ratings of 80 and 150 V. They are ideal for high gain switching applications such as print hammer drivers, stepper-motor controls, solenoid drivers and switching regulators. They can also be used in linear circuits for motor controls and amplifiers. Series available in 3-pin TO-3 and TO-66 chassis mounted hermetically sealed metal packages. From stock, they are priced at \$4.30 (100 quan.) Contact Mr. Howard Wasserman, Unitrode Corp., 580 Pleasant St., Watertown, Mass. 02172.

Circle Reader Service #312

MINI ZERO-VELOCITY PICKUP



Pickups provide a constant amplitude voltage output independent of gear speed. Sensors are particularly useful for applications requiring very slow-speed readings. Specs: 1 1/2 in. long x 7/16 in. dia.; operating range, -40°C to $+90^{\circ}\text{C}$; power supply, 9 to 18 Vdc; output voltage, 400 to 800 mV rms. Price, \$20 list; delivery from stock. Contact Joe DeLaurentiis, Airpax Electronics/Controls Div., 6801 Sunrise Blvd., Ft. Lauderdale, Fla. 33313.

Circle Reader Service #313

2½ DIGIT DPM FOR \$50



The AD2002 is a 5 Vdc powered unit with a staircase technique to convert analog input signals to digital form for display. Featuring accuracy of $0.5\% \pm 1$ digit with 10 mV resolution, it accepts unipolar, single ended input signals over a range of 0 to 1.99 V. It uses 7-segment incandescent RCA Numitrons for display and operates at 4 readings/s with optional trigger and hold for up to 200 readings/s. Analog Devices Inc., Rte. 1 Industrial Park, Box 280, Norwood, Mass. 02062. (617) 329-4700.

Circle Reader Service #334

FEED-THRU CAPACITORS

Miniature feed-thrus, Type DA, are for bypassing rf interference within the VHF and UHF freq. ranges. Applications include: solid-state oscillators, broadband radio amplifiers, directional power sensors, solid-state microwave sources, and transponders. Prime characteristics are: dcwV—150 Vdc to +125°C; op. temp. range—55° to +125°C; dielectric withstanding voltage—750 Vdc. Pricing, \$1.39 ea. in 100 lots; availability, 3-4 wks. Contact Marketing Dept., Electronics Div., Allen-Bradley Co., 1201 S. 2nd St., Milwaukee, Wis. 53204.

Circle Reader Service #335

CORE MATERIAL IS INSENSITIVE TO HEAT

Ampex is producing 18-mil ferrite cores from a proprietary, temperature independent (TIN) material that operates from -25 to 100°C without temperature compensation. Claimed to be the first major materials improvement since 1962, it permits up to 25% savings in design and manufacture of core components by eliminating thermal sensors, heat sinks, and blowers. The optimum operating point remains constant and the "shmoos" or operating envelope is unchanged with temperature. The uniformity of peak and switch times and output amplitude is also increased. Ampex, 13031 West Jefferson, Marins del Rey, Ca. 90291. (213) 821-8933.

Circle Reader Service #336

POWER FILM RESISTORS

A series of 8 metal oxide film resistors double the power capacity in a std. package. The ROH devices offer a power range from 3.8 to 20W at 220°C, with voltages from 7.5 to 40 kV, resistances from 100 Ω to 8 G Ω and tolerances to $\pm 0.5\%$. These are for power circuit applications requiring high stability, accuracy and long component life. Typical applications include meter multipliers, bleeders, voltage dividers and dropping and filter resistors. Inherent low inductance and capacitance permit their use in many ac applications also. Resistance Products Co., 914 S. 13th St., Harrisburg, Pa. 17104. (717) 236-5081.

Circle Reader Service #337

DIFF AMP OFFERS HIGH CMR

This wideband diff amp amplifies low-level signals with common mode voltages of ± 300 V, and with $\pm 0.003\%$ linearity. It outputs ± 10 V at 100 mA from dc to 100kHz. Guard-to-ground exceeds 1,000 M Ω . CMR is 140 dB at dc and 120 dB from dc to 60 Hz with 1k Ω unbalance in either input lead. Switch selectable 12 dB/octave Bessel filter. Model 124A, \$520 each: 30-60 days. John Hueckel, Neff Inst. 1088 E. Hamilton, Duarte, Ca. 91010 (213) 357-2281.

Circle Reader Service #338

THICK FILM NETWORKS



A complete line of DIP style thick film resistor networks are suitable for automatic insertion and testing equipment. Networks come in std. single-width coated (CDP) styles with 14 and 16 pins, or in double-width styles with up to 24 pins. Power rating (at 70°C) is from 1 to 1¼ W for the single-width styles. Resistance range is from 10 Ω to 1 M Ω with tolerances of $\pm 1\%$, $\pm 2\%$, $\pm 5\%$ and $\pm 10\%$. Standard TC is ± 200 PPM/°C, and can be provided with TC tracking to ± 25 PPM/°C as well as resistor ratio matching to 0.1%. Dale Electronics, Inc., Dept. 860, Box 609, Columbus, Nebr. 68601.

Circle Reader Service #339

SELF-SCAN® POWER SUPPLY

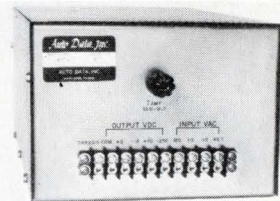

Supply with 4 outputs, fold back current limiting, good regulation and sequencing is for use with Burroughs Self-Scan® panel displays. Both high and low voltages are provided for digitally driven gaseous displays. Time-sequenced outputs provide proper turn-on for resetting digital circuitry. It may be purchased with or without sequencing. Unit features outputs of -12, +5, +30 and -250 V with currents to 3.0 A and time delays up to 2 s. Auto Data, Inc., 333 Kirby St., Suite 105, Garland, Tex. 75040. (214) 272-6238.

Circle Reader Service #340

DPM HAS REMOTE DISPLAY

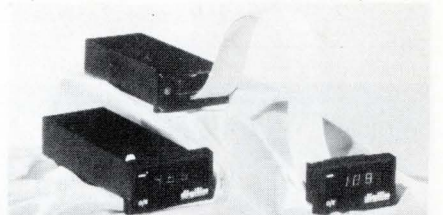

This remote LED display assembly shrinks behind-the-panel space to less than ¼" and extends from the end of the DPM package from 18-48" at the end of a flexible cable. Used in shallow panel or closed-environment applications, such as cockpits, this display is 1.33"x2.6", and allows the meter to be placed elsewhere. Model 3330/32, \$290; \$230 to OEMs; stock. Stan Ericsson, Digilin, 1007 Air Way, Glendale, Ca.

Circle Reader Service #341

PRESS INSTALLS TERMINALS

All types of chain terminals can be quickly applied to solid or stranded wire, from 26 to 10 AWG. With capacity of 3 tons, the 6000 Series press installs a range of terminal thicknesses and configurations with ease. These include open "U" ring tongue terminals, eyelets, all std male and female quick disconnects, as well as custom-designed terminals. Press is easy to maintain, and plugs into any 115 Vac outlet. Available on lease or purchase. Zierick Mfg. Corp., Radio Circle, Mt. Kisco, N.Y.

Circle Reader Service #342

SCHOTTKY MULTIPLEXERS

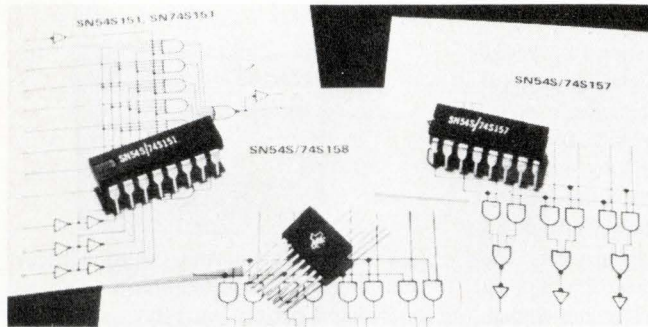

Three multiplex circuits are now available in Schottky. They are the SN54S/74S151, an 8-line-to-1-line multiplexer; the SN54S/74S157, a quad 2-line-to-1-line multiplexer with non-inverting data lines; and the SN54S/74S158, a quad 2-line-to-1-line multiplexer with inverting data lines. The S151 is pin compatible with the standard 151 and features a strobeable control input. The Schottky 157, also pin compatible with its standard counterpart, is designed specifically for doubling the data sources of any input or data line. The S158 routes data from one of two data sources for a 4-bit word and features only 1 1/2 equivalent gate delays in the inverting data lines. Texas Instruments Inc., Inquiry Answering Service, Box 5012, M/S 308, Dallas, Tex. 75222.

Circle Reader Service #318

HEATERS BEND AND FOLD

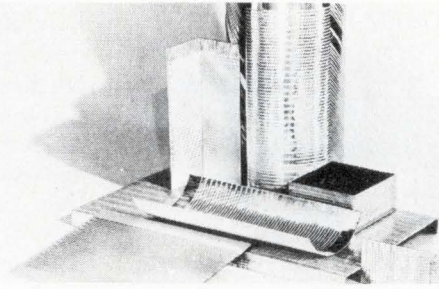

Thin, flexible heating elements provide a uniform temperature surface ranging from 10°F above ambient to 450°F. Aluminum foil, circuit pattern and substrate are laminated according to Watt-density desired. Two to 8 mils thick, they bend, curve, fold or flex to any configuration and operate from several ac or dc voltages from 3-230 V. Avery Products, 415 Huntington Dr., San Marino, CA. 91108.

Circle Reader Service #319

SCR TURNS OFF FAST



The turn-off time of 10 μs is claimed to be the fastest ever at 710 Arms current rating. Forward and reverse V from 50-600V. Applications include motor controls and welders. Max peak 1-cycle surge current is 9000 A. Available in liquid or air cooled heat exchangers. 10-99 quantity, 600 V, 450PF60 (ceramic) \$117; 451PF60 (plastic) \$105.30; stock. Semi. Div., Int. Rectifier, El Segundo, Calif. 90245.

Circle Reader Service #320

HIGH PERFORMANCE OP AMP

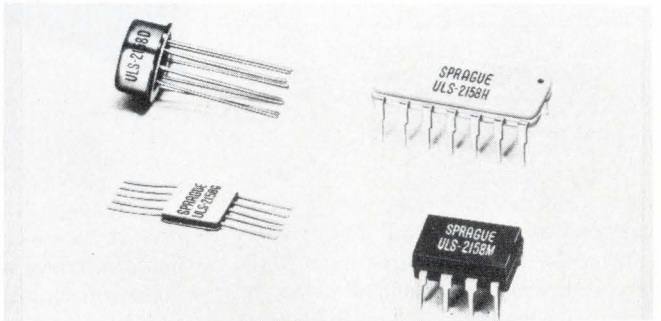

You can substitute the 2158 for the 748 to secure improved performance characteristics over a broader temperature range. It features high common mode input voltage range, low input offset voltage (typically 0.7 mV), low input offset currents (typically 2 nA), low input bias currents (typically 35 nA), input resistances typically 3 MΩ, and high open loop voltage gains (typically 250 V/mV). Added features include offset null capability and input and output protection. Small quan. pricing for ULN-2158 commercial device is \$2.04 ea. (1-24) and the ULS-2158 (military) is \$2.94 ea. Sprague Electric Co., 233 Marshall St., North Adams, Mass. 01247.

Circle Reader Service #321

For 29¢* - How Good Can This New Reed Relay Be?

*Quantity of 1 million

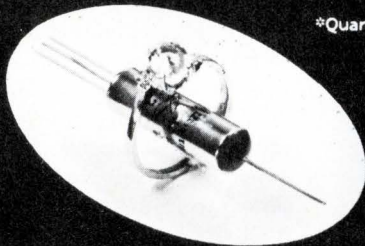

DAMN GOOD!

Our new 1A Series offers Mil Q 9858A specs at the lowest commercial prices: Hermetically sealed coils — Magnetically shielded for high density packing — Switches 1 amp or 250V @ 20 watts — Coil voltages of 1, 3, 5, 6, 10, 12, & 24 volts — Contact resistance less than 100 milliohms — Micro size .275" OD x .950" long.

How do we do it at that price? Our secret is patent pending.

FREE SAMPLES
to letterhead or phone requests.

Electronic Applications Co.
2213 Edwards Ave.
So. El Monte, Calif. 91733
(213) 442-3212
Known for quality

Circle Reader Service #34

LED BACK-LIT DISPLAY

This 0.27-in. x 0.16-in. "Superdigit" has one LED/segment. A one-piece molded plastic light pipe assembly with fly's eye lenses on the surface diffuses the light. Viewing angle is 140°. The 10-lead DIP measures 0.55 in. x 0.355 in. and is end- or side-stackable. Recommend 10-20 mA/segment for dc or multiplexed common cathode operation. FND-70, 100 up, \$3.95/digit. Fairchild MOD, 3500 Deer Creek Rd., Palo Alto, Ca. 94304.

Circle Reader Service #322

MACHINE WRAPPABLE I/O BOARD

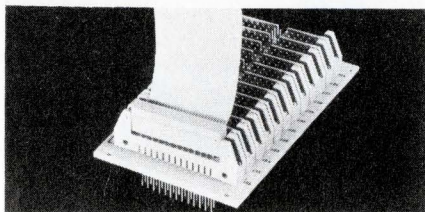

This new series of machine wrappable input/output connector boards provide up to 312 lines, in groups of 26. The H-2938 series are 3.8 x 2.6 in. and compatible with the entire EECO 2-D dual-in-line socket board series. The mating connection can be made with the H-4922 flat ribbon connector or H-4919 individual crimp wire type connector. The price is as low as 14¢/connection point. Electronic Engineering Co. of California, Electronic Products Div., 1441 E. Chestnut Ave., Santa Ana, Calif. 92701.

Circle Reader Service #323

75¢ ELECTRONIC TIMER

This universal timer, Model 555 produces fully controllable time-delays between 1 ms and one hour. If the timer is allowed to run free, it can be set to oscillate at any frequency between 1 MHz and 1 pulse/h (or, 3.6 mHz). Intended for automobiles, home appliances, industrial control systems, and sophisticated electronic equipment, the timer can be used for time delay, time sequencing, pulse generation, missing pulse detection, frequency division, pulse width modulation, and pulse position modulation. \$0.75 (100-up) Signetics Corp., 811 E. Arques Ave., Sunnyvale, Calif. 94086.

Circle Reader Service #324

A. W. Haydon Company motors... problem-solvers for Hewlett-Packard

Minimum magnetic interference, reversibility, accurate positioning and low cost are some of the features offered by two A. W. Haydon motors used in the Hewlett-Packard Model 10 programmable calculator.

Amazingly versatile, the calculator combines plug-in modules with a wide number of options which allow it to be adapted to a host of disciplines using mathematics, statistics and other functions.

One option, for instance, permits often-used programs to be stored on magnetic cards. The cards can then be fed through a built-in magnetic card reader for speedy data and program entry.

But herein lay design problem No. 1. Find a motor capable of feeding the cards in and out at a smooth, constant speed. Also, one which would keep electromagnetic interference to a minimum to prevent the input data from being adversely affected.

The answer? An A. W. Haydon

43100 reversible dc motor. Widely used for timing and control applications, the 43100 series features permanent magnet construction encased in a steel shell to minimize stray electromagnetic fields. Another design advantage: a hollow cage ironless rotor which eliminates cogging. Result: the magnetic card is fed through the reader at a smooth constant rate of speed.

Problem No. 2 was to find a motor capable of driving the Model 10's alphanumeric printer. Accurate positioning and economy were essentials. The answer was "on the shelf" . . . a standard A. W. Haydon 12 vdc ID05 stepper motor which offers accuracy and dependability at an attractive low cost.

If your own design problems encompass timed motion or control, our broad range of synchronous, dc timing and stepper motors — plus our extensive engineering experience — can help solve these problems and lower your costs. Try us and see.

Write for our Motor Catalog.

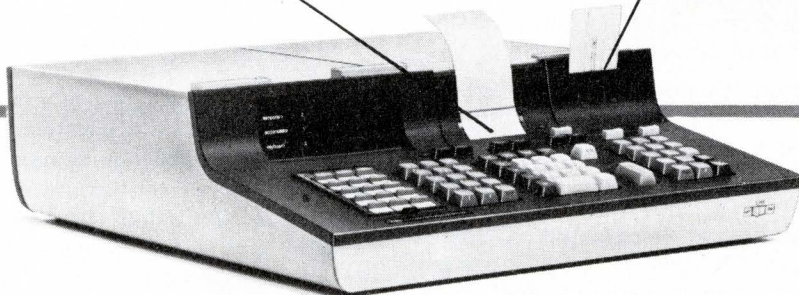
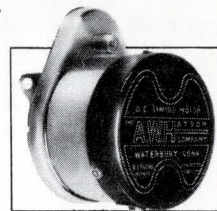
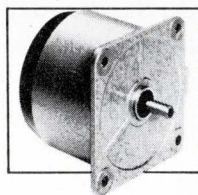

A. W. HAYDON CO. PRODUCTS

NORTH AMERICAN PHILIPS CONTROLS CORP.

A NORTH AMERICAN PHILIPS COMPANY
Cheshire, Conn. 06410 • (203) 272-0301

Circle Reader Service #35

the only printed circuit Relay

that plugs into your PC board without SOCKETS or SOLDERING

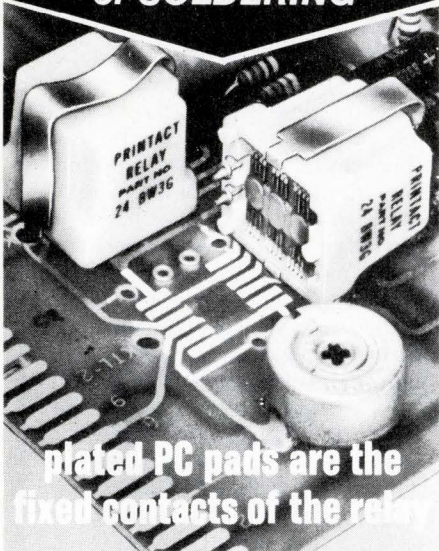

plated PC pads are the fixed contacts of the relay

Printact[™] MAGNETIC LATCHING AND NON-LATCHING RELAYS

The only relay designed to make full use of printed circuit technology. Unlike others adapted with terminal pins or sockets for solder mounting, Printact plugs directly into your module. Precious metal plated PC pads mate with shorting bar contacts on the pivoting armature, which is the single moving part. Held by a permanent magnet, it eliminates return springs, pigtailed, electrical and mechanical connections—assuring reliability for millions of cycles.

Inherent Custom Features include: Low Thermal EMF, Low Contact Bounce, Impedance Matching, 45-60 db Isolation, Bifurcated Contacts, and Encapsulated Coil—all at low cost!

Send for Test Sample and PC Board Preparation Aids to simplify design and production of your module.

For action write or call 212—EX 2-4800.

Executone

PRINTACT RELAY DIVISION
P.O. Box 1430EE
LONG ISLAND CITY, N.Y. 11101

Circle Reader Service #36

SUBSYSTEM PRODUCTS

CAPACITOR LINE

A line of capacitors, ranging from 0.001 to 20 μ F with tolerances to $\pm 1\%$ and rated to 600 Vdc have the same ratings and dielectrics, as well as the same form factors, as Electrocube units. Every capacitor listed in the Electrocube catalog is available from distributor stock. Contact Dick Grove, Elpac, Inc., 18651 Von Karman, Irvine, Calif. 92664. (714) 833-1717.

Circle Reader Service #325

PUSH-ON/PUSH-OFF CB

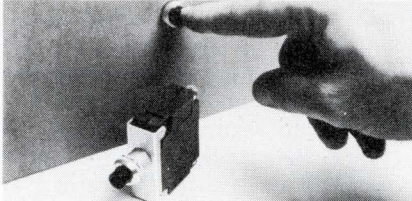

Available in single-pole models, these push-on/push-off hydraulic-magnetic circuit breakers feature continuous current ratings from 0.2 to 30 A, to 65 Vdc or 250 Vac, 60 or 400 Hz. Interrupting capacities are to 2000 A. for panel-mounted OEM applications, quick-on and screw type terminals are available. Options include time delay characteristics, instantaneous trip, and special-function internal circuits. Heinemann Electric Co., 131 Magnetic Dr., Trenton, N.J. 08602.

Circle Reader Service #326

FULL FLOOD RED LED

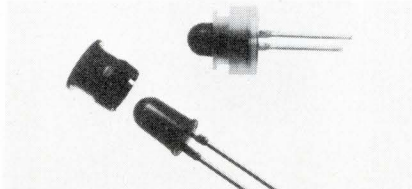

LED lamp provides a large, full flood viewing red light instead of the usual small red spot in the center of a larger package. The RL-21 is in a red-diffusive molded package. The viewing area extends 0.140 in. beyond the face of the mounting clip for a full 180° viewing. Radiating area is 0.2 in. in dia. with ideal visual display for indicating functions. Leads are 0.025 sq. for wire-wrapping, soldering or PC board mountings. It operates on only 1.7 V at 20 mA. LED sells for 65¢ in 1000 quan.; delivery from stock. Litronix, Inc., 19000 Homestead Rd., Cupertino, Calif. 95014.

Circle Reader Service #327

MINIATURE RELAY LINE

Miniature relays built to Mil-R-5757C specs come in bifurcated pattern for 3 A resistive @ 28 Vdc or Vac, 1 PST through 2 PDT; and in single pattern for 10 A @ 28 Vdc or 115 Vac resistive or inductive. High sensitivity telephone relays are available for both ac and dc to 10 A. Type "J" submin. micro-switches, with snap action also available. Contact Jerry Hall, J. W. Miller Co., 19070 S. Reyes Ave., Compton, Calif. 90221.

Circle Reader Service #328

MULTI-LAYER CAPACITORS

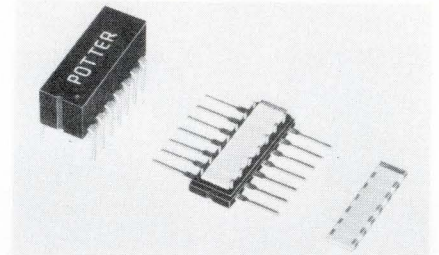

Monolithic NPO ceramic capacitor matrices in DIPs are designed for use in delay lines, RC networks, and capacitor assemblies. IC compatible units have up to 16 capacitors from 50 pf to 0.1 μ f. Priced from \$1 each, 6-8 weeks. David Flowers, Potter Co., 500 W. Florence, Ingelwood, Ca. 90301 (213) 678-2651

Circle Reader Service #329

REPEAT CYCLE TIMER

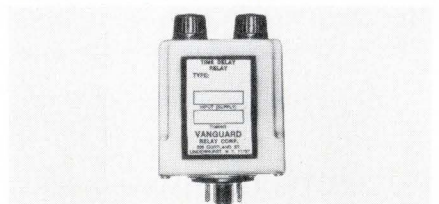

Plug-in, enclosed timer has two fixed or adjustable timing cycles and SPDT, 10 A switching. Combining the timing functions of two separate timers into one, this hybrid unit has solid state circuitry to control the operation of the output relay. Operation is on all ac and dc voltages from 24 V. It has applications in environmental cycling, machine or process control, automation, instrumentation, annunciator, business machines and many others. Unit priced at \$25.50, with quantity discounts. Contact B. S. Gilman, Vanguard Relay Corp., 225 Cortland St., Lindenhurst, N.Y. 11757.

Circle Reader Service #330

MONOLITHIC FET-INPUT OP AMP

Priced at \$5.00 in 100-unit quantities, the 8007 is a pin-for-pin replacement for the 101A, 709, 740 and 741 op amps. The device offers input bias current of 2 pA, 6 V/ μ s slew rate, $10^{12}\Omega$ input impedance and internal freq. compensation. It is packaged in a low-profile 8-pin TO-99 case. A special version, the 8007A, offers max. bias current of 1 pA at 25°C. This device has its case isolated from the monolithic chip, allowing you to force the case to the same potential as the inputs. This eliminates any current flow between case and input pins, and is the key to operating the device at 1 pA bias. Intersil, 10900 N. Tantau Ave., Cupertino, Calif. 95014.

Circle Reader Service #331

SEQUENCE ONE-BY-ONE

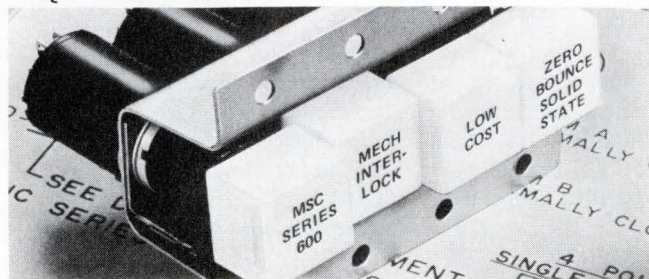

Actuating any pushbutton releases any previously engaged station. A mechanical interlock keeps it depressed to indicate which button was last operated. Position is retained after power failures. Single rows or column to 10 switches use combinations of one thru six pole contact forms A, B and C. Master Specialties, 1640 Monrovia, Costa Mesa, Calif. 92627.

Circle Reader Service #332

FET OP AMP LINE

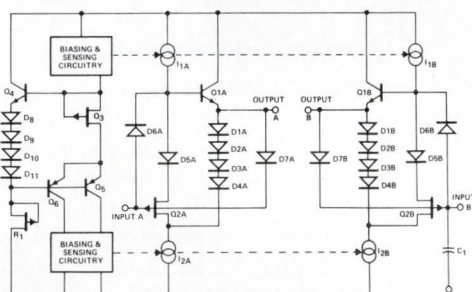

The HA-2000 is a monolithic unity gain differential amplifier stage with JFET inputs and bipolar transistor outputs. It is intended for use as high impedance input buffers for operational amplifiers comparators, or any linear circuit function. The HA-2050 combines the advantages of very high slew rate, 120/ μ s, a bandwidth of 20 MHz, 1 pA input current, and an input resistance of $10^{12}\Omega$. Settling time for the device is 400 ns. It is ideal for use in sample-and-hold circuits, A/D, D/A, and sampled data systems. Completing the FET input family is the HA-2060. This device features a gain bandwidth product of 100 MHz, input impedance of $10^{12}\Omega$, bias current of 1 pA, a 35 V/ μ s slew rate, and a power bandwidth of 600 kHz. Harris Semiconductor, Box 883, Melbourne, Fla. 32901.

Circle Reader Service #333

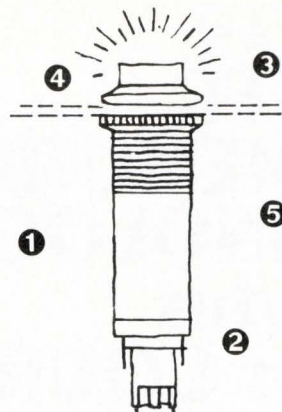

Push button—and lighted too!

Of course. The push button Series 80 lighted decorator line of switches from Grayhill. Your choice of:

- 1 **Actuation**—Momentary or alternate action.
- 2 **Circuitry**—Single pole, single throw; single pole, double throw; double pole, double throw.
- 3 **Styling**—Square, round, bezel, colors, lighted.
- 4 **Mounting**—Front panel, sub-panel or bushing. Lamps replaceable from front.
- 5 **Five designer colors . . . and lighted too!**

And if what you want isn't covered in the variations above, we can design one that is. We also have a companion line of indicator lights—Series 81.

For our latest Engineering Catalog write or phone:
Grayhill, Inc., 543 Hillgrove Ave.,
La Grange, Illinois 60525
(312) 354-1040



Circle Reader Service #38

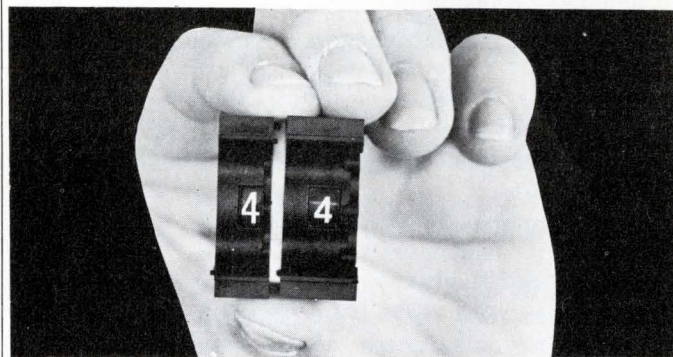

The thin switch

Designed for the new micro panels.

ECo's series-1976 rotary thumbwheel switches are only 0.35 inches wide, yet a lot of features are packed into that small space. Including: — 38 standard codes — 8, 10, and 12 positions — lighting — mother-board compatible terminals — component-mounting provisions — and field-adjustable stops. And, they're all backed by ECo's exclusive 2-year warranty.

Free Send today for our 8-page Series-1976 brochure describing the most complete line of thin switches available anywhere;



Electronic Products Division
Electronic Engineering Company of California
1441 East Chestnut Avenue, Santa Ana, California 92701
Telephone: (714) 547-5651
Dist. by: G.S. Marshall — Hall-Mark — Schweber

Circle Reader Service #39

You CAN MASTER THE MEMORIES TECHNOLOGY with this 7-PART COURSE

It took almost one year for the editors of *The Electronic Engineer* to research and compile the most comprehensive memory course available. Seven chapters guide you through this complex field, from delay lines to magnetic bubbles, with schematics and applications all along the way.

Thirty-six top engineering specialists from every phase of memories contributed their expertise. Intertechnological ballyhoo has been stripped away to reveal each aspect on its merits and show where it properly fits. The course covers:

fundamentals—definitions, types of storage, why we store, and the memory as a black box.

memory types—coordinate and content addressable, pushdown stacks, mainframes, bulks, ROMs, RAMs, and shift registers.

magnetic mainframes—core, plated wire, mag films, and linear transformers.

non-magnetic mainframes—bipolar, MOS, hybrid, optical, and organization by number of dimensions and wires.

bulk storage—cards, paper and mag tape, optical, disc, drums, domain wall, and semi-conductor bulk memories.

systems applications—hierarchies, interfacing, minicomputers, controllers, displays and ROMs as logic.

future memories—criteria for picking winners, magnetic bubbles, charge coupled devices, holographic and table of comparisons.

This Course on Memories costs only \$5.00 postpaid and includes an examination. Those who wish to take the examination will receive a *Certificate of Completion* free of charge. Send the coupon and your check or money order to: Course Editor, The Electronic Engineer, One Decker Square, Bala Cynwyd, Pa. 19004. E-8

Send me your new Course on **Memories**. Payment of \$5.00 is enclosed. Send the Course to me at:

Name _____

Company _____

Address _____

City _____ State _____ Zip _____

Check here for quantity prices. E-8

LAB INSTRUMENTS

DIGITAL STOP WATCHES

Various models are available with a wide range of full scale values from milliseconds to hours. These units are available with internal time base or external 60-Hz time base, and in "count down" as well as time interval configurations. BCD output is a standard feature. The Series 2600 are packaged in an extruded aluminum case with a cast aluminum bezel. Prices start at \$221.00 for a 3-digit, 60-Hz time base Model 2630. Digital Instruments Div., Electronic Research Co., 10,000 W. 75th St., Overland Park, Kans. 66204.

Circle Reader Service #344

SELF-CONTAINED TRIGGER GENERATOR

This unit requires no external power and no adjustments to produce 2-ns, 100 mA current pulses. Power consumed only when pulse is generated, so 9-V battery lasts 2×10^{11} (200 billion) pulses. Waveshape independent of input drive pulse. 1-4, \$175; 5-9, \$150; 10-24, \$125; stock. Mullett Assoc., 349 Culver Blvd., Playa del Rey, Calif. 90291.

Circle Reader Service #345

SWEEP/SIGNAL GENERATOR



This wide band (1.0 to 1400 MHz) unit, designated the Model 2000, provides cw to full band (500 MHz) sweep width on each of three (PIN diode) switched bands. Bands covered are 1 to 500, 450 to 950 and 900 to 1400 MHz. Frequency output is leveled to within ± 0.5 dB and PIN DIODE LEVELING and ATTENUATION provides a calibrated output of from +10 dBm (10 mW) to -80 dBm for use as a laboratory instrument. The PIN diode attenuator may be programmed for output level, a-m, or pulse modulation. \$1375, 30 day delivery. Wavetek, Box 651, San Diego, Calif. 92112.

Circle Reader Service #346

WITHSTANDS 100 G SHOCK

Two dc-rf electrostatic voltmeters offer input impedance to $3 \times 10^{15} \Omega$, accuracy to 0.25% fs, repeatability better than 0.05% fs, true rms response regardless of waveform or level, and flat frequency response. Optical peak adapter makes crest readings. Model LVE, 200 V fs to 6 kV fs; Model KVE ranges from 3 kV fs to 140 kV fs. Rack mounting optional. Beckman Inst., 89 Commerce Rd., Cedar Grove, N.J. 07009.

Circle Reader Service #347

Master the NEW TECHNOLOGIES with EE's Practical Courses

COUNTER REDUCES QUANTIZING ERROR

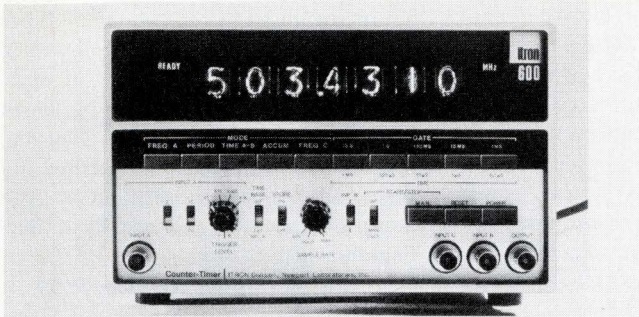

A unique input-triggering method, called Synchrostart, synchronizes the internally-controlled gate with the signal frequency, reducing quantizing error from ± 1 to $+1, -0$ counts. Measures dc to 512 MHz, period, time interval, frequency ratio, totalizing, and stopwatch. Options include BCD output, 6 or 7 digits, high-stability time base, input isolation, and rack adapters. Model 600, 50 MHz, \$750; Model 600H, 512 MHz, \$1,025. Newport Labs, 630 East Young St., Santa Ana, Calif. 92705.

Circle Reader Service #348

PORTABLE 525-MHz FREQUENCY COUNTER

This 525-MHz counter module, which is useful to measure communications transmissions, meets FCC measuring requirements when it's equipped with an optional temperature-compensated crystal oscillator. The Model 5303B's sensitivity is 25 mV up to 80 MHz, and 100 mV to 500 MHz. The input is protected against accidental external overload. \$1195: 5300A mainframe and 5303B 525-MHz counter module. \$175: Option 01, the temp.-compensated oscillator (< 5 parts in 10^7 change in freq. from 0° to 50°C and aging rate < 1.2 parts in $10^6/\text{yr}$). \$195: 5310A battery pack. 4 wk delivery. Inquiries Mgr., Hewlett-Packard Co., 1601 California Ave., Palo Alto, Calif. 94304.

Circle Reader Service #349

PORTABLE PULSE GENERATOR



Compact unit features rep rates from 2 Hz to 20 MHz in 7 overlapping ranges, 5-ns typ. and 7-ns max. rise and fall time from 10-90% amplitude, width from 20 ns to 200 ms, and 1 to 5-V amplitude into 50 Ω . Model 99, \$285, from stock. A similar unit, the Model 88, with a built-in +5 V TTL power supply costs \$395. Datapulse Div., Systron-Donner, 10150 W. Jefferson, Culver City, Calif. 90230.

Circle Reader Service #350

Compiled by the editors of The Electronic Engineer, these courses present completely authoritative and up-to-date guidance in using every aspect of the new technologies they cover:

Data Terminals—Basics of data transmission • Keyboards • Line Drivers and Receivers • Modems • Multiplexers • Minicomputers as Front Ends • Teletype-writers • Facsimile equipment • Data Adapters

Memories—Memory types • Magnetic mainframes • Non-magnetic mainframes • Bulk storage • Systems applications • Future memories

Optoelectronics—Physics of light • Materials for sources and detectors • Amplifiers • Practical applications (light choppers, modulators, card and paper-tape readers, counters.)

MOS Integrated Circuits—Processing and applications of MOS circuits • Complimentary MOS • MOS memories (random access, read only, associative memories and cost) • Testing of complex MOS circuits

Authored by recognized experts in their respective fields, these courses are the one sure way to keep ahead in these changing times. Each course includes an examination for those who wish to qualify. All who pass the free examination will receive a formal Certificate of Completion suitable for framing.

To order copies of these courses, return the coupon below with your check or company purchase order to: **Course Editor, The Electronic Engineer, One Decker Square, Bala-Cynwyd, PA 19004**

Please send me the following courses:

Quantity	Cost
_____ Data Terminals @ \$5.00 each	_____
_____ Memories @ \$5.00 each	_____
_____ MOS Integrated Circuits @ \$5.00	_____
_____ Optoelectronics @ \$4.00 each	_____
Total _____	

Check enclosed P.O. # _____ enclosed

Name _____

Company _____

Address _____

City _____ State _____ Zip _____

E-8

LITERATURE

Op amp applications

A 6 V/ μ s-slewing FET-input operational amplifier is the subject of this application note. Circuit diagrams illustrate such applications as log and anti-log amplifiers, a photocell amplifier, peak detector, sample and hold circuit,

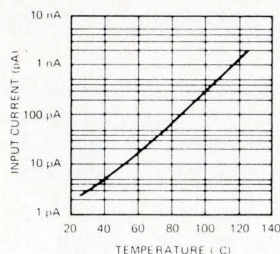

high impedance buffer, and Wein bridge oscillator. You'll also find details on the \$5 op amp's design, input current, input offset voltage drift, and wideband noise performance. Intersil Inc., 10900 N. Tantau Ave., Cupertino, Calif. 95014.

Circle Reader Service #353

Training videotape catalog

For technical training purposes, here are 106 different videotapes to choose from. Prices are given for the tapes, available in 1/2-in. EIAJ-1 and other formats. There's a 15-tape practical transistor course, tutorials on microwave instrumentation, and using s-parameters. Also, you'll find a tape on electronics counters, a guide to digital magnetic tape recording, and a course on oscilloscopes. Hewlett-Packard Co., 1601 California Ave., Palo Alto, Calif.

Circle Reader Service #354

Electromagnetic status indicators

For PC board mounting, these 0.3-in., light reflecting, single electromagnetic status indicators offer high speed, inherent memory, and low power (only 1 mW/s to set an indication). This data sheet provides the details on PC board mounting, coil assembly, dimensional data, character colors, and the advantages of built-in steering diodes. Ferranti-Packard Ltd., Electronics Div., 121 Industry St., Toronto 15, Ontario, Canada.

Circle Reader Service #355

Control systems

The Duo-Scan alarm and control system family, featuring double transmission so that the system actually checks itself, is the subject of this brief catalog. There are descriptions, photos, diagrams, and applications information for Duo-Scan encoders and decoders, a time division multiplex system, power supplies, an audio tone transmitter, and a three-frequency FSK receiver. Integrated Systems Inc., 2315 Interstate 85, Norcross, Ga. 30071.

Circle Reader Service #356

Minicomputers are not the answer

... to easing problems in communications, programming, and the expansion of hardware. Not conventional mini's, anyway, says this eye-opening brochure from GRI Computer Corp. Entitled "If minicomputers are the an-

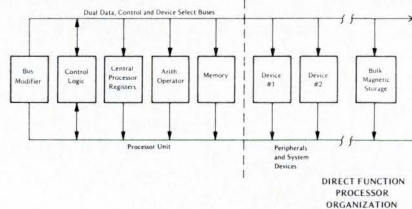

swer, what was the question?" it suggests that the answer is GRI's direct function processor, of course, on which GRI has a patent. GRI Computer Corp., 320 Needham St., Newton, Mass. 02164.

Circle Reader Service #357

Semiconductor stock and price list

Representing such manufacturers as Fairchild, Motorola, RCA, General Electric, Monsanto, Harris, National, Signetics, and more, this 100-page catalog provides stock and price information for hundreds of solid-state products. Listed are digital and linear ICs, LEDs, liquid crystals, COS/MOS ICs, diodes, transistors, ROMs and PROMs, silicon gate MOS/LSI, op amps, and many others. There are also details on the ROM programming service. Semiconductor Specialists Inc., Box 66125, O'Hare International Airport, Chicago, Ill. 60666.

Circle Reader Service #358

Modems

A synchronous modem capable of automatic answer operation at 2400 b/s over dial-up telephone lines is described here. Included also are theory of operation, a PC card outline drawing, block diagram, data modem timing diagram, diagrams of calling and answering station call procedure sequences, and more. Intertel, 6 Vine Brook Park, Burlington, Mass. 01803.

Circle Reader Service #359

Computer benchmarks— 24-bit vs 16 and 32

Datacraft, a manufacturer of 24-bit minicomputers, has prepared a set of three FORTRAN math benchmarks. For example, an integer statement such as $J = J + (I*3)/(250*J - 1) + 10,000$, iterated one million times, runs in 55 seconds in their \$10,900 DC 6025/5 computer, requiring only 625 memory words. Since their computer addresses memory directly, Datacraft hopes to prove it runs faster in theirs than in any 16-bit machine, and even in 32-bit's such as the IBM 1130 or PDP-10. If you want a copy of the benchmarks, or don't believe theirs and want to write your own, write to Jim Dixon, Datacraft, 1200 NW 70th St., Fort Lauderdale, Fla. 33307, or

Circle Reader Service #360

Reed switch applications

Applications covered in this 24-page manual include the operation of magnetic reed switches with permanent magnets and electromagnetic actuation. The manual explains how Hamlin would solve a variety of application

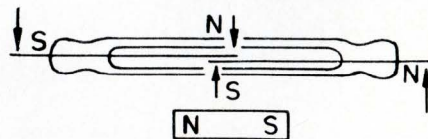

problems and then explains the benefits of their solution. In addition there's data on physical dimensions, arc suppression, terms and definitions, and more. Hamlin Inc., Lake Mills, Wis. 53551.

Circle Reader Service #361

1972 Engineering catalog

Here are 104 pages of circuit diagrams, photos, dimensional drawings, materials, ratings, operating features, delivery information, and prices for Grayhill's product lines. This includes rotary switches, pushbutton switches, termination hardware, wire ties, and solid-state relays. You'll find everything you need to select, specify, and order any of these products in this comprehensive catalog. Grayhill Inc., 535 Hillgrove Ave., La Grange, Ill. 60525.

Circle Reader Service #362

TV chroma system

An application note from RCA discusses a flexible IC color demodulator for color TV, detailing the use of one of their circuits in a color TV receiver. There's a complete block diagram of a color receiver; schematics illustrate the

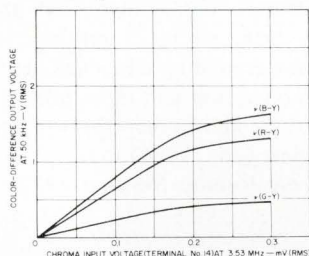

Demodulation linearity

interconnections of the circuit to peripheral components and drive circuitry; and graphs indicate the performance of the color demodulator circuitry. RCA, Solid State Div., Box 3200, Somerville, N.J. 08876.

Circle Reader Service #363

TV products

Organized by basic product function, this 72-page catalog provides details on picture monitors, signal generators, vectorscopes, waveform monitors, oscilloscopes, spectrum analyzers, oscilloscope cameras, and accessories. Technical discussions introduce several product categories in which items are grouped by standard or system. General descriptions and photos are included. Tektronix Inc., Box 500, Beaverton, Ore. 97005.

Circle Reader Service #364

Power transistors

All kinds of power transistors are covered in this 40-page catalog. Complete specs are given in chart form for planar power, rf power, high voltage, switches, industrial, four-layer diodes, power chips, and more. Graphs illustrate such characteristics as current gain and saturation voltage, and you can read about available custom products. Kertron Inc., 7516 Central Industrial Dr., Riviera Beach, Fla. 33404.

Circle Reader Service #365

Triac and SCR guide

Simplifying your selection of an ECC device from hundreds of competitive types is this 16-page interchangeability and cross reference guide. There's a list of package types for both the original device and its replacement, and package dimensions and lead configurations for all of ECC's triacs and SCRs. ECC Corp., Box 669, Euless, Tex. 76039.

Circle Reader Service #366

Laser label reader

Cogni-Tag™, a universal label reader, is described in this brochure along with its applications in supermarkets, warehouses, general material handling, mail order, airports, production lines, and more. The writeup also discusses the high information density of its small label, wide code-printing tolerances, direct computer interface, and other features. Maddox Readers Inc., 1 Harriet St., Norwalk, Conn. 06851.

Circle Reader Service #367

Diode applications

Reprints of a tutorial on diode applications in microwave circuits are available from AEL. Examples of the circuit optimized semiconductor and package are included. There's a table listing the more common applications and the diodes used in them, and then several examples are selected from the table and explored in detail. American Electronic Laboratories Inc., M/S 1123/T, Box 552, Lansdale, Pa. 19446.

Circle Reader Service #368

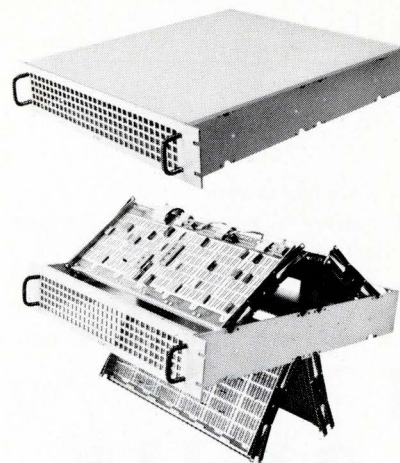

Augat enclosures. You can do a lot with 3 1/2 inches.

Example: Augat's 3 1/2-inch-high drawer assembly will package up to 720 DIP's. That's a lot. What's more DIP's are always in easy reach. Panel frames have unique two-way hinges for accessibility or removal.

Augat rack assemblies also give you plenty of packaging density. Plus flip-up access to panels for fast repairs or design changes.

Smallest of all, our new mini-rack assembly — with small racks and plug-in panels — lets you subdivide logic more flexibly than before.

Whichever way you want to go, you can count on Augat for all your enclosure needs. And probably pay less money than you're paying now, thanks to our off-the-shelf supply.

Augat. The ones who pioneered the plug-in panel. Call us for panels (with automatic wire wrapping available), enclosures, sockets, accessories. Or write for our catalog.

Augat Inc., 30 Perry Avenue, Attleboro, Mass. 02703. (617) 222-2202. Our representation and distribution is nationwide and international.

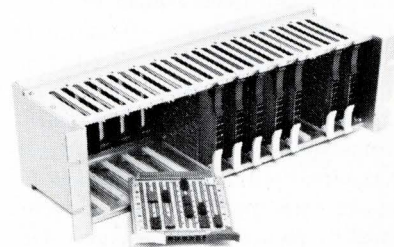

Plug into Augat®

See Augat's new Dead or Alive at the WESCON Show, Booths 3410-3411
Circle Reader Service #40

ICC 2400 bps modem

Features, technical data, and typical application diagrams for Modem 24, a new 2400-bps modem, are provided in an 8-page data sheet. Several features of the modem, which uses MOS/LSI tech-

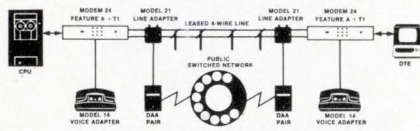

nology, are system error diagnosis from a single site, on-line evaluation of the data communication system, and modem self-test capability. International Communications Corp., 7620 NW 36th Ave., Miami, Fla. 33147.

Circle Reader Service #369

Paper tape system

Microdata's new high-speed fan-fold paper tape system, for use with the Micro 800 and Micro 1600 computers, comes in a single, rack-mount package. This bulletin lists the features of the system, specs, and instructions, and describes the controller and reader/punch assembly. Microdata Corp., 644 E. Young St., Santa Ana, Calif. 92705.

Circle Reader Service #370

Data modem facts

Here's a short brochure describing a line of low-speed, Bell-compatible data modems. They're available in a variety of configurations, featuring TTY, EIA, or TLT interfacing; loop back testing and visual diagnostics; and dedicated or dial line operation. Pulsecom, 5714 Columbia Pike, Falls Church, Va. 22041.

Circle Reader Service #371

Data communications equipment

GE's DigiNet® family of data communications equipment is described in a 10-page booklet covering acoustic couplers, modems, wideband data systems, multiplex units, and data concentrators. Descriptions tell of capabilities and features of each member and are accompanied by photos of the products. General Electric Co., Data Communications Products Dept., Box 4197, Lynchburg, Va. 24502.

Circle Reader Service #372

Klystrons, twystrons, and twt's

Categorized by function, the microwave tubes introduced in this 24-page catalog are suggested for light radar, communications, heavy radar and accelerator applications. Detailed specs are given in chart form for the products appropriate to each application. Included also are power vs frequency indices for cw and power klystron amplifiers. Varian, Palo Alto Tube Div., 611 Hansen Way, Palo Alto, Calif. 94303.

Circle Reader Service #373

Telephone coupling transformers

Applications of telephone coupling transformers for interconnect of voice/data modem terminals in telephone systems are discussed here. You'll read about telephone system design, terminology, and the capabilities of voice-grade dial-up and dedicated lines for audio and data transmission. There are

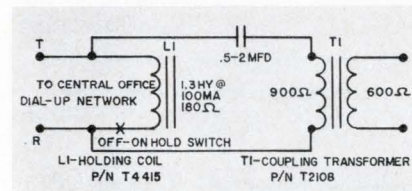

briefings on return loss, frequency response, distortion, longitudinal balance, and applications using bridging transformers, 4-wire terminating sets, hybrid transformers for channel isolation, and holding coils for dc isolation. Microtran Co. Inc., 145 E. Mincola Ave., Valley Stream, N.Y. 11582.

Circle Reader Service #374

Integrated circuits

LTE wants you to know they're a source for GTE-Sylvania's entire IC line, so they've published a catalog showing you all that's available. Typical characteristics and applications are listed for hundreds of devices, including SUHL I, SUHL II, digital function arrays, the 7400N series, and linears. The catalog is packed with circuit diagrams illustrating many of the SUHL I and logic circuit functions. Lansdale Transistor & Electronics Inc., Bldg. 4, Shetland Industrial Ctr., Andover, Mass. 01810.

Circle Reader Service #375

Miniature lighting products

Hundreds of miniature lamps are included in this 28-page catalog. It opens with illustrations of typical bulb and base combinations. Following are charts of specs and applications for industry standard and the T-2 lamps, both listed in numerical order. Still other sections cover hardware, sockets, and lenses; dimensional diagrams; slide base drawings; cartridge lamps, sockets, and lenses; disc lamps™ for edge lighted panels; and microminiature lamps and sockets. Sylvania Miniature Lighting Products Inc., 526 Elm St., Kearny, N.J. 07032.

Circle Reader Service #376

Instrumentation amplifier

Describing the use of this low-drift module as a bridge amplifier, this data sheet provides specs and features as well as curves for common-mode rejection vs frequency and gain error vs frequency and settling. You'll also find applications data, circuit diagrams, techniques for grounding and shielding, and data on operation and input protection. Function Modules Inc., 2441 Campus Dr., Irvine, Calif. 92664.

Circle Reader Service #377

Diode and transistor catalog

Gain, noise figures, and power output curves for HP's high frequency transistors are provided in this 8-page catalog. As for diodes, there are descriptions for Schottky, pin, impatt, and step recovery types. And chip, beam lead, and other

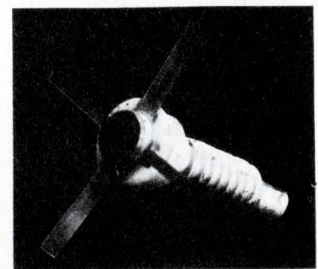

configurations for hybrid IC applications are shown. In addition to electrical characteristics, dimensional drawings illustrate each component. Hewlett-Packard Co., 1601 California Ave., Palo Alto, Calif. 94304.

Circle Reader Service #378

Electronic editing brochure

The editing systems described in this brochure are for use with video quadruplex recorders. The 12-pager opens with a discussion of electronic editing, pre-edit previewing and planning. It then goes on to explain the SMPTE edit code and available EECO editing systems, as well as possible savings with "off-line" edit-scheduling using low cost helical equipment and the basic use of modular editing equipment. Electronic Engineering Co. of Calif., 1441 E. Chestnut Ave., Santa Ana, Calif.

Circle Reader Service #379

Pots and dials catalog

With 84 pages of product information, you're sure to find all the information you need on precision pots and counting dials. For both product lines there are electrical, mechanical, and en-

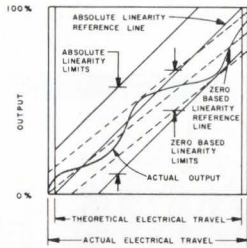

vironmental characteristics and specs, features, photos, and line drawings. Handy selection charts offer quick identification. Amphenol Connector Div., Controls Operations, 120 S. Main St., Janesville, Wis. 53545.

Circle Reader Service #380

Voltage reference diode guide

Covering voltage reference diodes such as zeners, temperature compensated zeners, and codistors (controlled forward voltage diodes), approximately 1000 JEDEC registered types are listed in this 8-page guide. The listings include typical temperature coefficients, nominal reference voltages and tolerances, max. impedance, max. temperature coefficients, case outlines, power dissipations, and more. Codi Semiconductor, Pollitt Dr. S., Fair Lawn, N.J. 07410.

Circle Reader Service #381

*No kidding around — I'm new,
I'm fast, 'n' I'm good lookin'!*



AUTO//SCAN
200
AUTOMATIC CIRCUIT VERIFIER

The AUTO//SCAN 200 is a fixed sequence circuit verifier ideal for testing printed circuit boards, substrate circuits, cables, and wire-wrapped backplanes — at speeds up to 8,000 tests per minute! Four times faster than comparable verifiers, the AUTO//SCAN 200 operates manually or automatically. With automatic point-to-point stepping, self programmable multiple circuit capability and simple controls, the AUTO//SCAN 200 requires no special training to program or operate.

Contact Walt Frey at:



EVERETT/CHARLES, INC.

2806 METROPOLITAN PLACE, POMONA, CALIFORNIA 91767
PHONE: (714) 593-2541

Circle Reader Service #42



Screen Star.

Introducing the star performer in any display system.

The Hughes Model 639 video storage unit. A complete electronic image memory system. With all the circuitry, power and controls built-in to make your displays versatile exhibitions.

It stores alphanumeric, graphic, and pictorial data. With high resolution, high-speed writing capability, selective updating and fast erasure.

It integrates signals (automatically enhancing weak or low level images). It speedily processes and stores input

signals for conversion into compatible information for TV displays, printers and other devices.

If you need close-up images, there's a zoom control, with a positioning joystick. And because it's flexible, it can be customized to star in any graphic display system.

Write: Hughes Display Systems, 2020 Oceanside Blvd., Oceanside, California 92054. Or call: (714) 757-1200.



Circle Reader Service #43

Card readers

Designed for use with IBM Systems/3 installations are these eight high-speed card readers. You have a choice of card readers with speeds ranging from 250 to 750 cards/min., and for 80-column or 96-column cards and stubs to match your System/3 Mod 10 or Mod 6. Capabilities and features of each card reader are provided. Bridge Data Products Inc., 738 S. 42nd St., Philadelphia, Pa. 19104.

Circle Reader Service #382

D/A converters

These optically isolated, line-powered, D/A converters add digital control to your power supplies, or anything you control with an analog voltage. This brochure tells you all about a series of DACs from Kepco, providing specs, details on features, digital inputs and analog outputs, accessories, and programming a power supply's voltage or current. Kepco Inc., 131-38 Sanford Ave., Flushing, N.Y. 11352.

Circle Reader Service #384

Transducer applications

Here you'll find information on the application of advanced solid-state transducer technology to the measurement of physical parameters such as pressure, stress, force, acceleration, and temperature. You'll read about devices used in process control, aerospace, transportation, blast, and biomedical applications. Kulite Semiconductor Products Inc., 1039 Hoyt Ave., Ridgefield, N.J. 07657.

Circle Reader Service #385

Voltage regulator applications

The 4-A hybrid circuit voltage regulator applications covered in this 12-page note include positive and negative regulation, remote sensing, and connections for various current levels. There are circuit descriptions and diagrams, and data on basic structure, analysis of foldback circuit, power dissipation, and operating considerations. RCA, Solid State Div., Route 202, Somerville, N.J.

Circle Reader Service #383

Transistor substitution guide

This guide will tell you how to replace any of 15,000 transistors with comparable devices from Radio Shack. Its 96 pages give detailed specs and electrical characteristics for 29 transistors (24 of which are custom made for Radio Shack by TI) and lists the hundreds of transistors each replaces. Get your copy for \$1 from Radio Shack, Dept. EP-1, 2617 W. Seventh St., Fort Worth, Tex. 76107.

Digital counter applications

Frequency measurements with a plug-in digital counter and current probes are the subject of this application note. You'll read about the advantages of using current probes for minimizing accidental grounds, loading effects, and monitoring signal currents at ground points. Plus, the counter/scope combination lets you see the waveform of the signal being counted. Tektronix Inc., Box 500, Beaverton, Ore. 97005.

Circle Reader Service #386

RUBBERIZED ABRASIVES

DEBURR SMOOTH POLISH



COMPLETE KIT \$750

CONTENTS: 8 tapered edge wheels $\frac{3}{8}$ " dia. x $\frac{3}{32}$ "; 16 cylinder points $\frac{1}{4}$ " dia. x $\frac{3}{4}$ " long; 16 bullet points $\frac{3}{32}$ " dia. x 1" long; 8 bullet points $\frac{3}{8}$ " dia. x $\frac{3}{8}$ " long; 8 straight wheels $\frac{1}{2}$ " x $\frac{1}{4}$ " x $\frac{1}{16}$ " hole; 16 straight wheels $\frac{3}{8}$ " x $\frac{1}{4}$ " x $\frac{1}{16}$ " hole; 8 straight wheels 1" x $\frac{3}{16}$ " x $\frac{1}{16}$ " hole; 2 wheel mandrels $\frac{1}{4}$ " shank; 2 point mandrels $\frac{1}{4}$ " shank. For use at speeds up to 25,000 RPM.

\$7.50 BUYS IT ALL — 80 piece introductory Kit 777 equally assorted in 4 grit textures: coarse, medium, fine and extra fine. **TRY IT** — Cratex Rubberized Abrasives improve the surface while preserving critical workpiece dimensions by its unique cushioning action. **FINISH THE JOB** — to your most exacting specifications — often in a single operation. **SEND FOR KIT 777** — or your **FREE SAMPLE** and catalog illustrating the full Cratex product line and its applications.

CRATEX[®] RUBBERIZED ABRASIVES

1600 Rollins Rd. • Burlingame, Calif. 94010
Sold through leading industrial distributors

Circle Reader Service #44

Jones barrier block catalog

Complete electrical and physical specs for 23 series of barrier terminal blocks are provided in this 16-page catalog. Hardware designed to increase the usefulness of these terminal blocks, such as marker strips and fanning strips, is also listed. Current carrying capacities of the series range from 5 to 90 A. Cinch Connectors, TRW Electronic Components, 1501 Morse Ave., Elk Grove Village, Ill. 60007.

Circle Reader Service #387

Ultra low bias op amps

Applications of two op amps with input bias currents of 0.1 and 0.01 pA and pin identical to the 741 op amp are discussed in this note. You'll find appli-

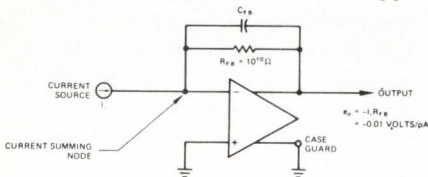

cations and diagrams for pico ammeter circuits, sample-and-hold circuits, and a gated integrator. Intersil Inc., 10900 N. Tantau Ave., Cupertino, Calif. 95014.

Circle Reader Service #388

Ac relay catalog

You'll read about three phase motor starters in this 12-page catalog as well as octal base relays, PCB relays, latching relays, and on/off and zero point switching relays. Features include less than 1-ms switching speeds, noise-free operation, minimum RFI and EMI, complete encapsulation, and compatibility with other solid state circuitry. Hamlin Inc., Lake & Grove Sts., Lake Mills, Wis. 53551.

Circle Reader Service #389

Data comm capabilities

Xerox Corp.'s capabilities in computer-controlled data communications systems are described here. The 8-page brochure describes their approach to system design, explains the benefits and features of Sigma systems, and summarizes available hardware, software, and support. Xerox Corp., Marketing Communications Dept., 701 S. Aviation Blvd., El Segundo, Calif. 90245.

Circle Reader Service #390



think woven

for connectability

Need a neat match for standard or specialized connectors? Woven Cable fits the picture with rollable, foldable, stackable adaptability. Woven connects!

WOVEN ELECTRONICS

A DIVISION OF SOUTHERN WEAVING COMPANY

P.O. Box 189, Mauldin, S.C. 29662, (803) 288-4411

Circle Reader Service #54

No other conductive elastomer can shield your electronic products against EMI as effectively as Xecon®, the whole line. Xecon gasketing is made with silver deposits on a stable, lightweight substrate in a silicone matrix. Temperature range for sustained operation is -60°C to 200°C. Xecon protection is available: as die cut waveguide and connector gaskets; in sheets; and custom molded and vulcanized to your own specs. Write for free EMI Handbook today. Metex Corp., 970 New Durham Road, Edison, N.J. 08817. West Coast: Cal-Metex Corporation, Inglewood, Calif. 90301.

METEX
CORPORATION

Now you can skip the EMI threat to the performance of your electronic packaging and products. Metex has all the answers—gasket materials that cover the entire product spectrum from commercial to ultrasophisticated. Thousands of Metex sizes and shapes on the shelf, including the versatile and effective Xecon® line. Write for free Design Guide today. Metex Corporation, Edison, N.J. 08817. West Coast: Cal-Metex Corp., Inglewood, Calif. 90301.

METEX
CORPORATION

Help stamp out EMI.

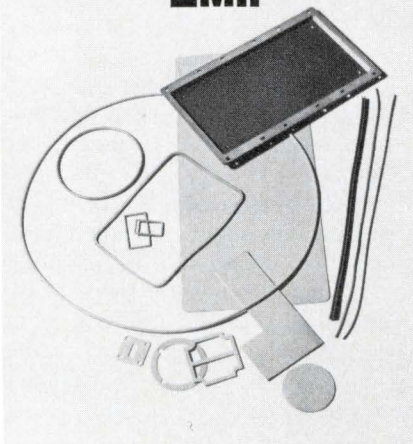

Circle Reader Service #45

Help your designs lead a shielded life.

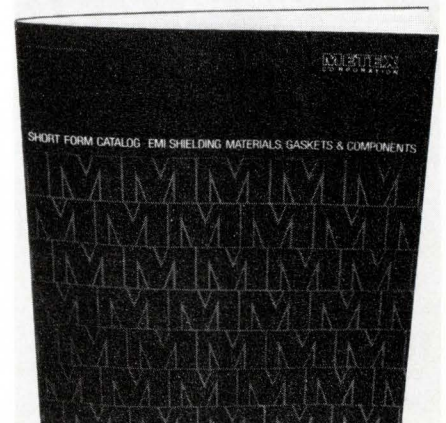

Circle Reader Service #46

Intertran applications

This brochure details the applications of Intertran, a modular data set for 4-wire twisted pair data communications facilities. It illustrates the use of the system for point-to-point transmission requirements and for online "star" con-

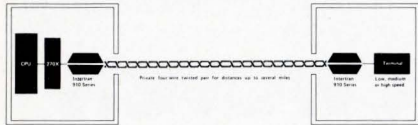

figurations involving several one-to-one communications links with common central processing. Computer Transmission Corp., 1508 Cotner Ave., Los Angeles, Calif. 90025.

Circle Reader Service #391

Fixed resistor Mil spec digest

Folding out to a handy chart, this fixed resistor digest provides a simple explanation of the Mil spec numbering system for seven major fixed resistor specs. How to interpret all the digits of the Mil specs numbering system is explained in tables at the bottom of the chart. Fixed Resistor Distributing Marketing, Box 12867, Philadelphia, Pa.

Circle Reader Service #392

Ac line conditioners

Here's an explanation of the Parafomer® principle of passive power conversion providing regulation combined with bilateral filtering of ac. It's included in a 28-page catalog of ac line conditioners, ac regulators, converters, inverters, and the new Paraswitcher® switching power supplies. Tele-Dynamics/Wanlass, Div. of Ambac Ind., 525 Virginia Dr., Fort Washington, Pa.

Circle Reader Service #393

Test equipment catalog

Prices, features, and specs are provided for a complete line of test equipment in this 16-page catalog. To give you an idea of what you might look for, there are digital VOMs, hand-size portable and general multi-purpose VOMs, FET VOMs with micropower, an industrial maintenance analyzer kit, portable panel instrument kits, accessories, a VOM selector chart, and much more. Triplet Corp., Dept. PR, Bluffton, Ohio 45817.

Circle Reader Service #394

Connectors and contacts

Miniature and microminiature rectangular plug and socket connectors and solderless crimp termination removable contacts are the subjects of this 34-page catalog. Dimensional diagrams and electrical and mechanical ratings are provided for each product. The catalog is offered to you by Continental Connector Corp., Woodside, Long Island, N.Y. 11377.

Circle Reader Service #395

Sockets for ICs

Sockets, carriers, and contactors for solid-state devices are described in this 24-page catalog. Selection charts provide quick reference by number of pins, method of mounting, material used, and part number. Flat pack, DIP, and TO type sockets are categorized as test or production sockets, and there's an interconnection table for universal sockets and mating connectors. Amphenol Barnes Div., 24 N. Lansdowne Ave., Lansdowne, Pa. 19050.

Circle Reader Service #396

Thick-film hybrid microcircuits

Here you'll read about the benefits of using thick-film hybrid microcircuits to solve circuit design and packaging problems. Comparing thick-film, thin-film, and IC techniques, this 8-page catalog covers costs, performance ranges, and time for product development, prototype delivery, and alteration turnaround. Specs and capabilities are also provided. Corning/Spacetac, Burlington Rd., Bedford, Mass. 01730.

Circle Reader Service #397

Linear applications handbook

There's a collection of 46 application notes on linear applications using monolithic and hybrid ICs in this 304-page handbook. You'll read about the use of regulators, op amps, JFET amplifiers, comparators, analog switches, pin diode drivers, and phase-locked loops in instrumentation communications, consumer, and military applications. Write on company letterhead to National Semiconductor Corp., 2900 Semiconductor Dr., Santa Clara, Calif.

Hand tool catalog

This huge catalog (185 pages) includes just about every small tool you could think of. You'll find descriptions for hundreds of pliers, screwdrivers, tweezers, soldering tools, deburring and grinding points and accessories. There's also data on many miscellaneous items and accessories such as tool kits and cases, cleaning solutions, lights, magnifiers, encapsulating materials, and more. This handy catalog is offered to you by Techni-Tool Inc., 1216 Arch St., Philadelphia, Pa. 19107.

Circle Reader Service #398

Power modules

Computer Products' 18 most popular encapsulated PC card mounted power modules are the subject of this brochure. In addition to providing applications information (it suggests use in powering op amps, data conversion modules, and various logic applications), the brochure discusses general features, short circuit protection, and trim connections. Specs, prices, and options are listed. Computer Products Inc., 1400 Gateway Dr., Box 23849, Fort Lauderdale, Fla. 33307.

Circle Reader Service #399

Transfer oscillator applications

A-m and fm measurements with transfer oscillators are the subject of this 20-page application note. It discusses general theory and operating procedures, pulsed rf, am measure-

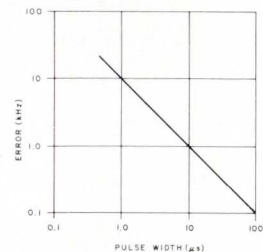

Approximate error in pulsed rf measurements

ments, fm deviation and incidental fm, use of the oscillator as an rf comb generator, and more. Hewlett-Packard Co., 1601 California Ave., Palo Alto, Calif.

Circle Reader Service #400

Buyer's alert

The National Association of Aerospace Subcontractors has put out an informative booklet to familiarize you with its member firms. Capabilities of the high-technology, small business companies serve such industrial markets as aerospace, automation, instrumentation, and more. National Association of Aerospace Subcontractors, 916 Silver Spur Rd., Suite 203, Palos Verdes Peninsula, Calif. 90274.

Circle Reader Service #401

Circuit board test systems

After discussing the advantages of automatic circuit board testing, this 16-page catalog goes on to describe a new family of computer-operated circuit board test systems. Covered in the discussion are configurations, functional testing, programming the systems, various measurements with the systems, writing a functional test program, reporting test results, and applications. Teradyne Inc., 183 Essex St., Boston, Mass. 02111.

Circle Reader Service #402

Line printers

For use in computer and communications systems, here is a medium-speed (250 or 1100 1/min.) and a high-speed (700 to 1800 1/min.) printer. The basic print format for each is 132 characters, with 120 and 136-character formats optional. These data sheets provide features and specs, and discuss capabilities, operating principles, and available options. Data Products, 6219 DeSoto Ave., Woodland Hills, Calif. 91364.

Circle Reader Service #403

Resistors and trimmers

Here's a 6-page short form catalog covering a line of precision resistors, trimmers, networks, and resistance measurement instruments. A series of performance tables, circuit diagrams, and illustrations describe a complete line of film resistors designed as direct replacements for precision wire-wounds, ultra precise resistors, voltage dividers, attenuators and more. Vishay Resistor Products, 63 Lincoln Hwy., Malvern, Pa. 19355.

Circle Reader Service #404

Enlarge your memory

Here's a brochure that tells you "how to enlarge your little memory" with add-on memory units for the DEC PDP-81, -11, and -12 minicomputers. You'll read about the advantages of purchasing add-on memory from an independent memory manufacturer, and the capabilities of the memories that go with each unit. Information Control Corp., 9610 Bellanca Ave., Los Angeles, Calif. 90045.

Circle Reader Service #405

Data transfer system

Basic operating information of the CAMAC data transfer system is provided in this 16-page collection of technical notes. The CAMAC is a modular data transfer system in which all modules, except the computer interface itself, are independent of the computer used. Advantages of this and other features of the system are outlined for you in these notes. LeCroy Research Systems Corp., 126 N. Rte. 303, West Nyack, N.Y. 10994.

Circle Reader Service #406

Free.
Our 1972 Product Guide.
Inside's everything we make
to solve more of your problems
better than anybody else.



One hundred and eighty pages cataloging all our new products, amplifiers, A/D and D/A converters, digital panel meters, function modules and accessories and linear integrated circuits that you need, available right now, from us.

Name _____

Title _____

Company _____

Address _____

City _____ State _____ Zip _____

Route 1 Industrial Park, P.O. Box 280, Norwood, Mass. 02062

 **ANALOG
DEVICES**

EE

Circle Reader Service #56

A significant breakthrough...

for the first time

- A modular form tracking filter that can be programmed in frequency for OEM applications
- Available in either single or programmable decade and bandwidth models
- Q's to 10,000,000

FEATURES: TTL/DTL programmable decade frequency ranges and bandwidths • zero phase error at center frequency • low amplitude error • constant bandwidth regardless of center frequency • simultaneous bandpass/bandreject and phase sensitive outputs • sweeps and tracks over 20:1 frequency range (30% overrange in sweep and track modes) • extremely sharp rolloff (skirts 10 Hz wide at 40 db down with 1 Hz bandwidth) • ultimate attenuation greater than 50 db • phase locks to either the input signal, or to an external frequency reference.

Sweep/track module available soon. Frequency range; 10 Hz-200kHz (.01 Hz on special order). Bandwidths; .3 Hz-3kHz (.01 Hz on special order).

UFAD CORP.

P.O. Box 96 ADA, MI. 49301
Telephone 1-616-676-9000

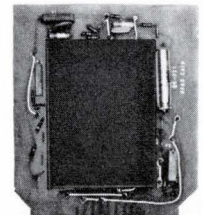

PN Q0-721 VOLTAGE
CONTROLLED OSCILLATOR

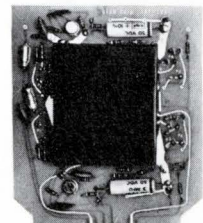

PN SBF-721 BANDPASS/
BANDREJECT FILTER

Circle Reader Service #47

Thermocouple system calibrator

The theory of operation of this new calibrator and its application in testing and calibrating thermocouple systems are covered in this 8-page technical brochure. It discusses the on-line use of the

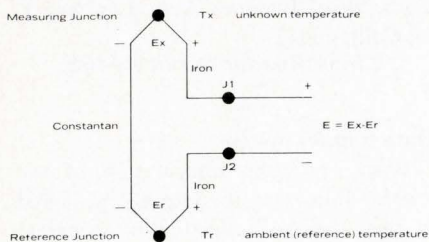

instrument, which allows the system under test to remain fully connected while being tested. General Resistance Inc., 500 Nuber Ave., Mt. Vernon, N.Y. 10550.

Circle Reader Service #407

Rf current probes

Current probe characteristics and details for fourteen different probe models are presented in 42 pages of technical information. The probes, intended for measuring RFI up to 1 GHz, are of hinged, two-piece design, enabling them to be clamped around a conductor without breaking it. Applications data, electrical and physical specs, and transfer impedance curves are included in the technical data. Singer Instrumentation, 3211 S. La Cienega Blvd., Los Angeles, Calif. 90016.

Circle Reader Service #408

Circuit protection catalog

The "fuseology" section in this 56-page catalog discusses basic fuse and circuit protection technology and includes time/current characteristic charts for the main fuse range. There are descriptions and complete specs for the following product lines: glass and ceramic tube fuses, fuseholders, fuse clips and blocks, automatic and manual reset circuit breakers, heavy and medium duty relays, alarm buzzers, and momentary action switches. Write on company letterhead for your copy to Littelfuse Inc., Dept. 19 PR, 800 E. Northeast Hwy., Des Plaines, Ill. 60016.

LSI design system

Here's a thorough description of Macrodata's FEDIS LSI design system. System operation is explained and there are illustrations of the command matrix, cursor, automatic alignment feature, pen plotter, and the CRT display/editor. Several of the software programs described include nodal generation, analysis, and validation; logic equation simulation and generation; and transient and crosstalk analysis. Macrodata Co., 20440 Corisco St., Chatsworth, Calif. 91311.

Circle Reader Service #409

Cooling for electronics

The equipment for electronics cooling covered in this catalog includes slot blowers, recessed blowers, centrifugal blowers, all kinds of fans, heat exchangers, grille panels, and more. There are also discussions of housing variations, and precision motors for use with the cooling equipment. McLean Engineering Labs., Princeton Junction, N.J. 08850.

Circle Reader Service #410

Rfi filters

Five series of rfi power line filters are covered in this 6-page catalog. A wide selection of case styles and termination arrangements are offered with the filters whose current ratings range from 1 to 60 A. And there's an application/specification selection chart which indicates the correct filter for a variety of applications. Corcom Inc., 2857 N. Halsted St., Chicago, Ill. 60657.

Circle Reader Service #411

Hard-to-find items

Edmund has published another catalog detailing thousands of unusual optical and scientific items. Its 148 pages cover everything from LED experiment kits, to fiber optics, to calculators. There's pollution testing equipment, bargains in labware, tools, components, and unusual lighting products—4,000 items in all. Edmund Scientific Co., 380 Edscorp Bldg., Barrington, N.J. 08007.

Circle Reader Service #412

Components catalog

Detailing Centralab's complete line of electronic components, this 20-page catalog covers ceramic capacitors, pots and trimmer resistors, pushbutton and rotary switches, technical ceramics, thick-film circuits, EMI/RFI filters, semiconductors, and optoelectronic products. Photos and/or dimensional drawings are provided for each product, as are important specs. Centralab Electronics Div., Globe-Union Inc., 5757 N. Green Bay Ave., Milwaukee, Wis. 53201.

Circle Reader Service #413

Power semiconductor data book

TI is offering you an 816-page data book packed with comprehensive information on their line of power transistors, thyristors, and power functions. There are sections on testing procedures, terms and definitions, cross-reference guides, and applications. Technological coverage is given to lead-bonding and chip-mounting techniques, mesa vs planar vs glass-mesa designs, and forward and reverse energy considerations. Selling for \$3.95, the data book is offered to you by Texas Instruments Inc., Box 5012, MS/84, Dallas, Tex. 75222.

Rf power transistors

There's a quick selection guide in this revised catalog of RCA rf power transistors that shows the entire line of rf types with ratings up to 75 W for applications at frequencies up to 3 GHz. It

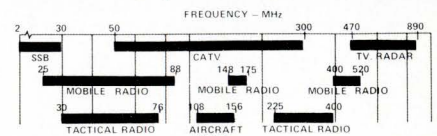

uses a bar chart of frequency allocations in conjunction with power-vs-frequency curves. And to help you compare and select devices, types are categorized by application. RCA Solid State Div., Box 3200, Somerville, N.J. 08876.

Circle Reader Service #414

THE ELECTRONIC ENGINEER

DISTRICT SALES MANAGERS

EDWARD G. SHAUD
BALA-CYNWYD, (Pa.) 19004
One Decker Square
(Area Code 215) SHerwood 8-2000

JACK RATTINGER
NEW YORK 10016-600 Third Ave.
(Area Code 212) OXford 7-3400

JOHN W. BERNHARDT
CHICAGO 60606-100 S. Wacker Drive
(Area Code 312) 782-1400

G. T. ALFANO
NEEDHAM HEIGHTS, MASS. 02194-
570 Hillside Ave.
(Area Code 617) 444-0010

TERRENCE D. BUCKLEY
THOMAS R. BORIS
LOS ANGELES 90020-3727 W.
Sixth St. # 202
(Area Code 213) DUnkirk 7-1271

RALPH PETERSEN
JOHN SLY
LOS ALTOS (San Francisco) 94022
199 First St., Room 335
(Area Code 415) 941-6655

RICHARD DUTE
CLEVELAND 44114-601 Rockwell Ave.
(Area Code 216) SUperior 1-2860

NEWTON B. COLLINSON
DOUGLAS B. BRODIE
ATLANTA 30309-1776 Peachtree St.
N.W.
(Area Code 404) 872-4723

HAROLD E. MOTT
RICHARD HERRANEN
Houston 77027
4151 Southwest Freeway
Suite 735
(Area Code 713) 621-7550

INTERNATIONAL BUSINESS OFFICES

London, SW1Y 6PB.....Max F. Holsinger
67-68 Jermyn St. St. James's Dir. European Sales
01-839 6318-9 K. J. Hendry, S. K. Elliott
Cables WHIP, LONDON S. W. 1

Manchester M22 5RQ.....D. I. Goulden
Hailetop, Wythenshawe Civic Centre 061 437 3293

4 Dusseldorf-Nord.....E. Hillerbrand
Eitelstrasse 32 R. Schomburg, H. Haibt
Dusseldorf 652031-2
Cables WHIP, DUSSELDORF

75 Paris 8e.....S. Brown-Joussard
70 rue de Ponthieu J.-C. Lamoine
Paris 359 65-77
Cables UIIP, PARIS 8E

Tokyo Clarence T. Sakaguchi
11-3, 2-Chome, Shinbashi
Minato-ku, Tokyo, Japan Tel. 591-6897

BUSINESS STAFF

BERNARD M. GITTELMAN
Publisher

DENNIS J. PERKINS
Promotion Manager

LOUIS L. MARINES
Marketing Services Manager

KAREN CHRISTIAN
Production Mgr.

BEVERLY TATUM
Production Asst.

WILLIAM HOWAT
Circulation Director

DAVID ELY
Circulation Manager

JOSEPH P. BABCOCK
Reader Service Manager

JOHN H. KOFRON
Chilton Research Services

C. R. WILHIDE
Washington Vice-President

Advertisers—August 1972

No liability is assumed for errors or omissions.
This index is published for a convenience.

AMF, POTTER & BRUMFIELD.....32, 33
Fuller & Smith & Ross, Inc.
AMERICAN TECHNICAL CERAMICS..Bet. DC-10 & DC-11
AMP, INC......IBC
Artkin-Kynett Co., Inc.
ANALOG DEVICES.....93
Schneider Parker Guy, Inc.
AUGAT, INC......87
Creamer, Trowbridge, Case & Basford, Inc.

BECKMAN—HELIPOT DIV......11-A
N. W. Ayer/Jorgensen/MacDonald, Inc.
BOKER'S, INC......35
Keystone Adv. Inc.
BURROUGHS CORP./E.C.D......37
Conti Adv.
BUSSCO ENGINEERING, INC......DC-10
T. F. Murray & Assoc., Inc.
BUSSMANN MFG. DIV., McGraw-Edison Co......40, 41
Henderson Adv. Co.

CENTRALAB DISTRIBUTOR PRDTS......77
The Brady Co.
CONDENSER PRDTS. CORP......78
MacMahon Adv., Inc.
CRATEX MFG. CO., INC......90
Wank, Williams & Neylan, Inc.

EECO.....83
The Robertson Co.
EDMUND SCIENTIFIC CO......96
Chittick Adv.
ELCO CORP......17
Mort Barish Assoc., Inc.
ELECTRONIC APPLICATIONS CO......80
EVERETT/CHARLES, INC......89
EXECUTONE, INC., Printact Relay Div......82
J. A. Richards

FAIRCHILD SEMICONDUCTOR.....13, 14, 15
Carson/Roberts/Inc.
FAIRCHILD SYSTEMS TECHNOLOGY.....54
Hall Butler Blatherwick, Inc.

GARDNER-DENVER CO......24, 25
GENERAL INSTRUMENT CORP......Bet. 48 & 49
Norman Allen Assoc., Inc.
GRAYHILL, INC......83
Carr Liggett Adv., Inc.

HEWLETT PACKARD, SAN DIEGO DIV......72
Phillips Ramsey Adv.
HUGHES AIRCRAFT CO......89
Foote, Cone & Belding

INTERSTATE ELECTRONICS CORP......DC-13
Chris Art Studio, Inc.

KEPCO, INC......4
Weiss Adv.

LEAR SIEGLER INC./E.I.D.
CIMRON INSTR......76
Manning/Bowen & Assoc.

MAGNECRAFT ELECTRIC CO......1
Marketronics, Inc.
MALLORY CAPACITOR CO......12
Artkin-Kynett Co., Inc.
METEX CORP......91
Mohr & Co., Inc.
MET-L-WOOD CORP......5
Armstrong-Desmond-Kennedy, Inc.
MICRO SWITCH.....49
N. W. Ayer & Son, Inc.
MONSANTO.....26
MOTOROLA COMMUNICATIONS & ELEC., INC......DC-4
Brand Adv., Inc.
MOTOROLA SEMICONDUCTOR PRDTS., INC......50
E. B. Lane & Assoc., Inc.

NO. AMER. PHILIPS CONTROLS.....81
J. B. Rundle Adv.
NYTRONICS, INC......9
Prentiss Court

POWERTEC, INC......7
Warren C. Wilson & Assoc.

RCA, Solid State Div......BC
Al Paul Lefton Co., Inc.
RAYTHEON CO......DC-8, DC-9
Provandie Eastwood & Lombardi, Inc.

SPERRY INFO. DISPLAYS DIV......30
N. A. Winter Adv.
SWITCHCRAFT, INC......23
Buti Roberts Adv.
SYSTRON DONNER.....2
Bonfield Assoc.

TEC., INC......DC-10
TELEDYNE CRYSTALONICS.....IFC
Gerard J. Gormley Adv., Inc.
TELEDYNE RELAYS.....35
S. Michelson Adv.
TELETYPE.....DC-2, DC-3
N. W. Ayer & Son, Inc.

USCC/CENTRALAB.....75
Brown Clark Elkus & Moses, Inc.
UFAD CORP......93
David H. Darsky & Assoc.

VARFLEX CORP......96
Varflex Corp.
VARIAN.....69
Herrick & Assoc.
VIDAR CORP......19
Lincoln Assoc.

WATKINS-JOHNSON CO......DC-11
Wm. C. Estler
WOVEN ELECTRONICS.....91
Prentiss Court

Do-it-yourself appliques

If you have a Xerox 720, 914, or 2400 Series copier, you can make appliques of any of your diagrams, spec details, or drawings. Simply insert the blank pressure-sensitive sheets in your copier, run your drawing through and you'll have your own pre-printed transfer sheet within seconds. Stanpat Products Inc., Covert & Main Sts., Port Washington, N.Y. 11050.

Circle Reader Service #415

Drawing aids

Samples of adhesive-backed letters, arrows, numbers, rules, symbols, ornaments, and shading mediums come with this 73-page catalog illustrating the hundreds of Formatt drawing aids available. You'll also receive a headline setter with printed guidelines along the edges of a vinyl carrier to help you apply evenly spaced and perfectly aligned headlines and symbols on your engineering drawings. Graphic Products Corp., 3601 Edison Pl., Rolling Meadows, Ill. 60008.

Circle Reader Service #416

Solderless terminals

You can get samples of new configurations added to Zierick's solderless terminals lines. There are 22-16 ring tongues with both long and short barrel; 22-16 and 16-14 spade and flanged spade terminals for barrier blocks; and 22-16 and 16-14 rectangular tongue with long and short barrel. All feature bright tin plating. Zierick Manufacturing Corp., 36 Radio Cir., Mt. Kisco, N.Y.

Circle Reader Service #417

Mercutron switch

Suggested for use in encoded keyboards, electronic calculators, control panels, or any other switching function requiring bounce-free operation is this new Mercutron switch. It's available in three configurations: as a keyboard switch with a tang for mounting a conventional truncated keytop, as a keyboard switch with an integral keytop, and as a pushbutton switch. Free samples are offered to you by Mechanical Enterprises Inc., 5249 Duke St., Alexandria, Va. 22304.

Circle Reader Service #418

Temperature recorder

This miniature 8-position temperature recorder has an accuracy of $\pm 1\%$ from 110 to 500°F. Suitable for testing electronic components, the heat-sensitive indicators (available in 10° increments) turn black upon exposure to calibrated temperatures. William Wahl Corp. offers a free evaluation sample. Temp-Plate Div., 12908 Panama St., Los Angeles, Calif. 90066.

Circle Reader Service #419

PC card guides

Here are free samples of Electro-Flex nylon guides for 1/16-in. PC boards. Their bow feature exerts tension (top and bottom) for improved card retention. The slot mounting pattern permits sufficient movement of the bowed guide to compensate for tolerance variations from card to card, and thus control rack "spreading." Snap-in installation means no rivets or other mounting hardware. Samples are offered to you by Electro-Space Fabricators, Centre Ave., Tipton, Pa. 19562.

Circle Reader Service #420



CHOOSE FROM OVER 4,000 UNUSUAL BARGAINS!

OPTICS • SCIENCE
ELECTRONICS

FREE CATALOG!

1,000's OF HARD-TO-FIND BUYS FOR INDUSTRY

Brand new 148-page easy-to-read edition packed with new products, charts, diagrams, illustrations. On-the-job helps; quality control aids, unique, exclusive items to speed your work, improve quality, cut development and production costs! Loaded with optical, scientific and electronic equipment available from stock for industry, research labs, design engineers, experimenters, hobbyists.

ONE SOURCE FOR ALL YOUR NEEDS

Tremendous variety. Terrific savings. Countless hard-to-get surplus bargains. Many "one-of-a-kinds" nowhere else. Ingenious scientific tools. Thousands of components: lenses, prisms, wedges, mirrors, mounts, all types of accessories. Hundreds of instruments: pollution testing equipment, lasers, comparators, magnifiers, microscopes, projectors, telescopes, binoculars, photo attachments, ecological items, black light equipment and America's largest collection of unique lighting products.

BUY DIRECT WITH MONEY-BACK GUARANTEE

Edmund ships over 5,000 orders monthly to America's largest industrials — every item guaranteed! You must be satisfied, or return your purchase in 30 days for your money back. Shop the catalog of America's largest Science-Optics-Electronics Mart with confidence! Get your FREE copy without obligation. No salesman will call. Write now for free catalog "E.E."



EDMUND SCIENTIFIC CO.
300 EDSCORP BUILDING
BARRINGTON, NEW JERSEY 08007
TELEPHONE: 609-547-3488

Circle Reader Service #48

Varglas silicone rubber sleeving stays this flexible from -70° to 400° F.

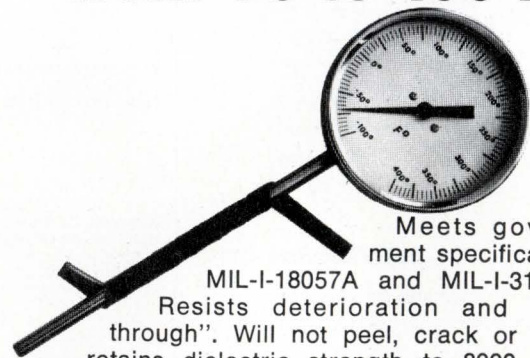

Meets government specifications MIL-I-18057A and MIL-I-3190/6. Resists deterioration and "cut-through". Will not peel, crack or craze . . . retains dielectric strength to 8000 volts. Fungus-resistant and flame-retardant, its tough, thin-wall construction and precision ID make it ideal for miniaturized designs. Brilliant, non-fading colors for instant coding. Choose from .010" to 3" ID, coils, spools, or 36" lengths. Delivery off-the-shelf or on order within one week.

Send for this and other free samples. Write:

Varflex

Varflex Corporation
506 W. Court Street, Rome, N.Y. 13440.

Circle Reader Service #49

Nylon. A new twist in cutting circular connector costs.

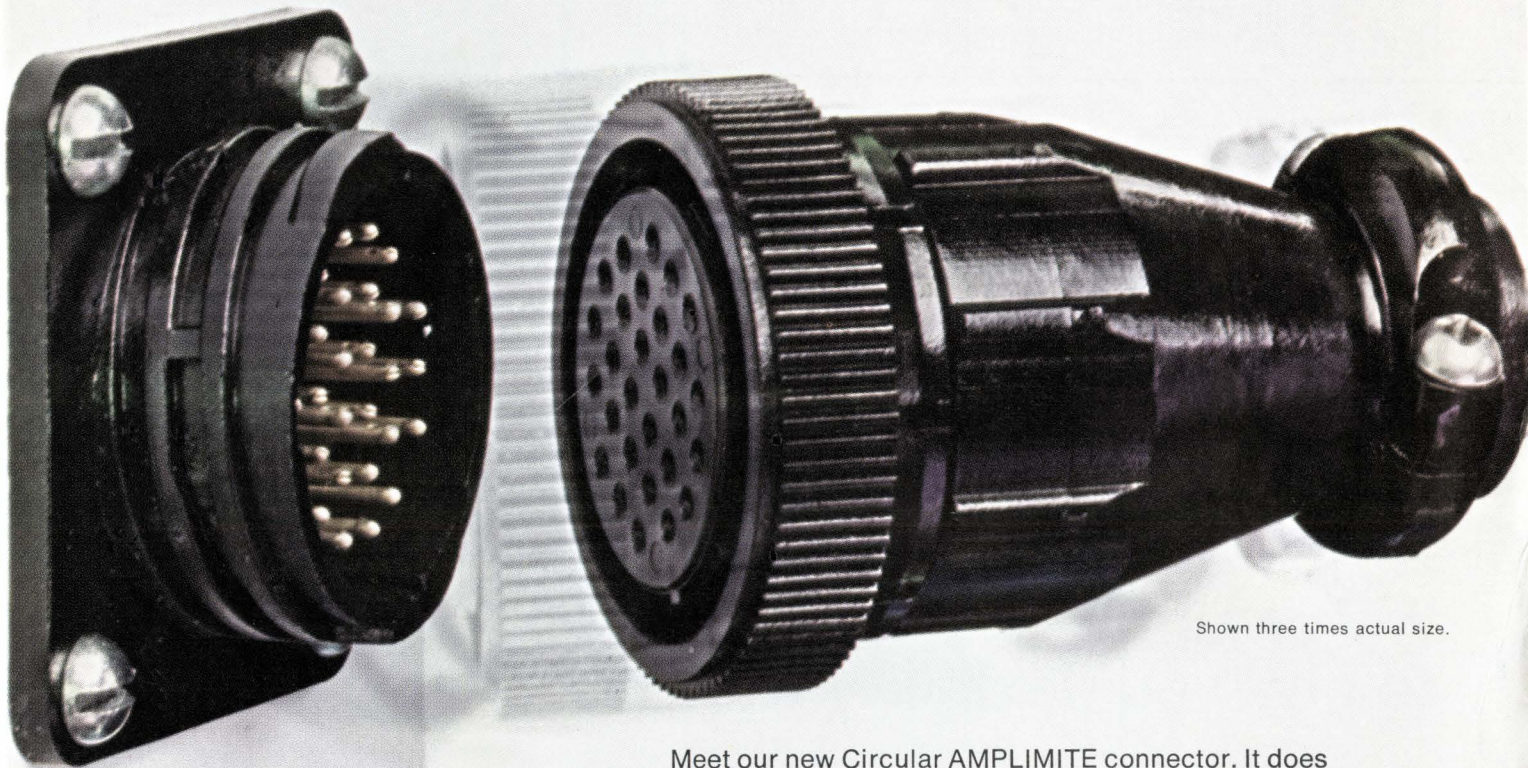

Shown three times actual size.

Meet our new Circular AMPLIMITE connector. It does everything a metal-shell connector will do. Except cost lots of money. We make it of high-strength, glass-filled nylon. So it's just as rugged . . . but lighter, nonconducting and less expensive.

Circular AMPLIMITE connectors cost less to buy. And less to use . . . because you can terminate their pin and socket contacts on our high-speed, automated, customer-provided machines. And load only the contacts you need.

We make this new nylon connector in most popular sizes, including 63-position, $1\frac{1}{16}$ -inch O.D.; 28-position, $1\frac{1}{8}$ -inch O.D.; and 8-position, $\frac{1}{2}$ -inch O.D. Mountable or free-hanging. Standard or splashproof. Rated 7.5 to 15 amp.

Ready for a new twist in circular connectors? Write for details to **AMP Incorporated, Industrial Division, Harrisburg, Pa. 17105.**

AMPLIMITE is a trademark of AMP Incorporated.

AMP
INCORPORATED

Manufacturing and direct sales facilities worldwide: Barcelona, Brussels, Buenos Aires, Frankfurt, London, Mexico City, Paris, Puerto Rico, Sao Paulo, s'Hertogenbosch (Holland), Sydney, Stockholm, Tokyo, Toronto, Turin, Vienna.

#50 Please send literature — Immediate Interest

#51 Please send literature — Possible Future Interest

CA3118AT
CA3118T

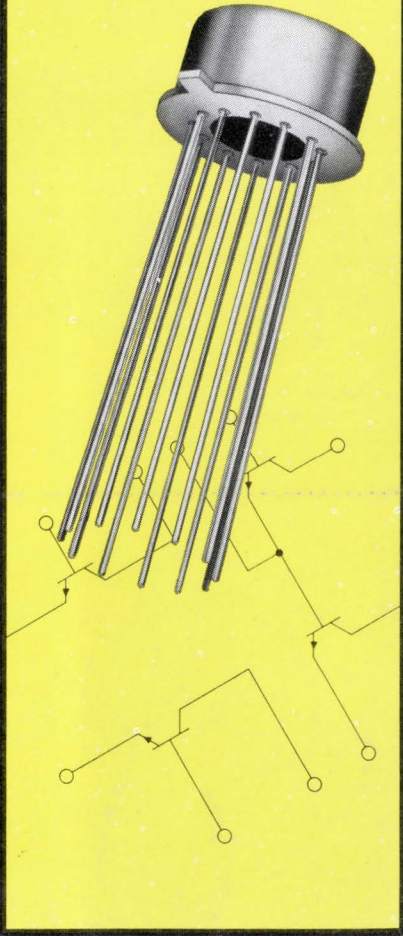

CA3146AE
CA3146E

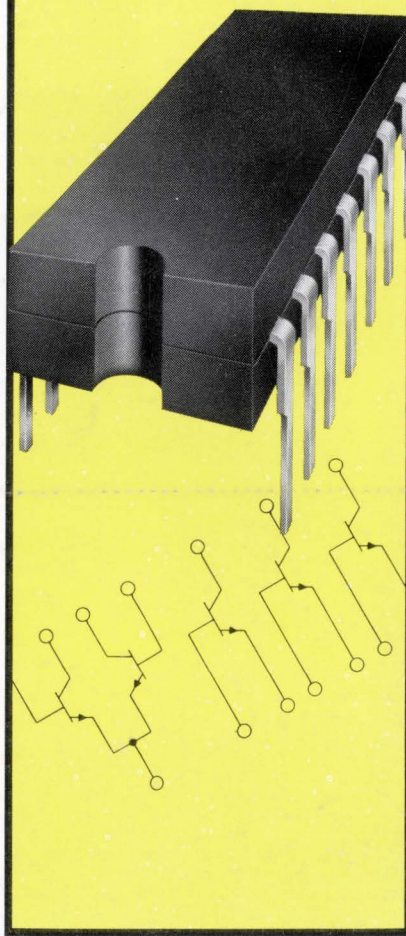

CA3183AE
CA3183E

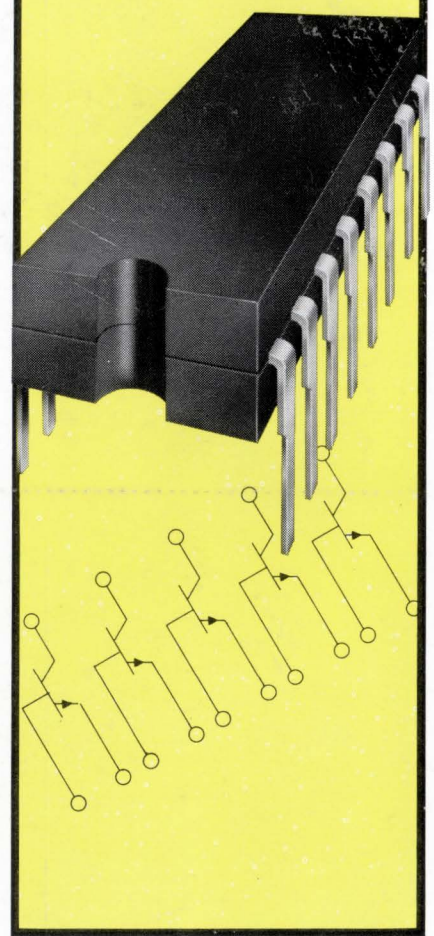

We've UPPED our V_{CE0} to 40 volts... to give you flexibility with extra muscle

We've taken our already popular CA3018, CA3046, CA3083 transistor arrays and upped their V_{CE0} ratings from 15 volts to 30 and 40 volts. The new CA3118AT, CA3118T, CA3146AE, CA3146E, CA3183AE, CA3183A now bring you a new level of design flexibility in our widely accepted line of monolithic transistor arrays.

They offer a broad variety of configurations — Darlington, differential amplifiers and uncommitted transistors — for communication, control, and instrumentation equipment. High-current types CA3183E and CA3183AE offer capability up to 75 mA.

If compact, economical design

and high voltage are important to you . . . use these new RCA arrays, CA3100 Series. They're the logical choice for lamp and relay drivers, thyristor triggering, and for most signal processing and switching systems from DC to 120 MHz. (If V_{CE0} to 15 volts meets your requirements, specify the standard CA3018, CA3018A, CA3045, CA3046 or CA3083.)

If you have been using discretes, take advantage of RCA's unequalled experience in the design and manufacture of high-quality transistor arrays. If you've been voltage- or current-limited by previous arrays — check RCA's six new types now.

For more information see your

RCA Representative or your local RCA Distributor. All types are available from stock in quantity for new designs. For technical data, write RCA Solid State, Section 59H, Box 3200, Somerville, N.J. 08876.

Type	V_{CE0}	I_C (max.) mA	Package	Price (1000-unit level)
CA3118AT	40	50	12L TO-5*	\$1.40
CA3118T	30	50	12L TO-5*	.98
CA3146AE	40	50	14L DIP**	1.40
CA3146E	30	50	14L DIP**	.98
CA3183AE	40	75	16L DIP**	1.50
CA3183E	30	75	16L DIP**	1.25

*Operates over full military temperature range of -55°C to 125°C

**Operates over ambient temperature range of -40°C to $+85^{\circ}\text{C}$

International: RCA, Sunbury-on-Thames, U.K., or Fuji Building, 7-4 Kasumigaseki, 3-Chome, Chiyoda-Ku, Tokyo, Japan. In Canada: RCA Limited, Ste. Anne de Bellevue 810, Quebec.

Circle Reader Service #52

RCA Solid State
products that make products pay off